

Part No. 060392-10, Rev. B
November 2015

OmniSwitch AOS Release 8 Network Configuration Guide



enterprise.alcatel-lucent.com

**This user guide documents AOS Release 8 for the OmniSwitch 6860 and OmniSwitch 6860E.
The functionality described in this guide is subject to change without notice.**

enterprise.alcatel-lucent.com Alcatel-Lucent and the Alcatel-Lucent Enterprise logo are trademarks of Alcatel-Lucent. To view other trademarks used by affiliated companies of ALE Holding, visit: enterprise.alcatel-lucent.com/trademarks. All other trademarks are the property of their respective owners. The information presented is subject to change without notice. Neither ALE Holding nor any of its affiliates assumes any responsibility for inaccuracies contained herein. (July 2015)



26801 West Agoura Road
Calabasas, CA 91301
(818) 880-3500 FAX (818) 880-3505
support@ind.alcatel.com

Service & Support Contact Information

North America: 800-995-2696
Latin America : 877-919-9526
EMEA: +800 00200100 (Toll Free) or +1(650)385-2193
Asia Pacific: +65 6240 8484
Web: service.esd.alcatel-lucent.com
Email: esd.support@alcatel-lucent.com

Contents

	About This Guide	xli
	Supported Platforms	xli
	Who Should Read this Manual?	xli
	When Should I Read this Manual?	xli
	What is in this Manual?	xlii
	What is Not in this Manual?	xlii
	How is the Information Organized?	xlii
	Documentation Roadmap	xliii
	Related Documentation	xlvi
	Technical Support	xlvi
Chapter 1	Configuring Ethernet Ports	1-1
	In This Chapter	1-1
	Ethernet Specifications	1-2
	Ethernet Port Defaults	1-2
	Ethernet Ports Overview	1-4
	Valid Port Settings	1-4
	Configuring Ethernet Port Parameters	1-4
	Enabling and Disabling Autonegotiation	1-4
	Setting Interface Line Speed	1-4
	Configuring Duplex Mode	1-4
	Setting Trap Port Link Messages	1-5
	Resetting Statistics Counters	1-5
	Enabling and Disabling Interfaces	1-5
	Configuring a Port Alias	1-5
	Configuring Maximum Frame Sizes	1-6
	Configuring Digital Diagnostic Monitoring (DDM)	1-6
	Configuring Flood Rate Limiting	1-6
	Configuring Flood Rate Limit Action	1-7
	Configuring Flow Control	1-7
	Enabling and Disabling Enhanced Port Performance (EPP)	1-8
	EPP - Check the Current Link Quality	1-8
	EPP - Diagnose	1-8
	EPP - Enabling	1-9
	Configuring Energy Efficient Ethernet (802.3az)	1-9
	Using TDR Cable Diagnostics	1-10
	Initiating a TDR Cable Diagnostics Test	1-10

Displaying TDR Test Results	1-10
Clearing TDR Test Statistics	1-11
Clearing Ethernet Port Violations	1-12
Link Monitoring	1-13
Monitoring Interface Errors	1-13
Monitoring Interface Flapping	1-13
Monitoring Window	1-14
Starting a Link Monitoring Session	1-14
Stopping a Link Monitoring Session	1-14
Interfaces Violation Recovery	1-15
Violation Shutdown and Recovery Methods	1-15
Interface Violation Exceptions	1-16
Interaction With Other Features	1-16
Configuring Interface Violation Recovery	1-17
Configuring the Violation Recovery Time	1-17
Configuring the Violation Recovery Maximum Attempts	1-17
Verifying the Interfaces Violation Recovery Configuration	1-18
Configuring the Wait-to-Restore Timer	1-18
Configuring the Wait-to-Shutdown Timer	1-19
Displaying Link Monitoring Information	1-20
Link Fault Propagation	1-20
Interaction With Interfaces Violation Recovery	1-21
Configuring Link Fault Propagation	1-21
LFP Application Example	1-23
Chapter 2	
Configuring UDLD	2-1
In This Chapter	2-1
UDLD Specifications	2-2
UDLD Defaults	2-2
Quick Steps for Configuring UDLD	2-3
UDLD Overview	2-4
UDLD Operational Mode	2-4
Normal Mode	2-4
Aggressive Mode	2-4
Mechanisms to Detect Unidirectional Links	2-5
Neighbor database maintenance	2-5
Echo detection	2-5
Configuring UDLD	2-6
Enabling and Disabling UDLD	2-6
Enabling UDLD on a Port	2-6
Configuring the Operational Mode	2-7
Configuring the Probe-Timer	2-7
Configuring the Echo-Wait-Timer	2-7
Clearing UDLD Statistics	2-8
Verifying the UDLD Configuration	2-8

Chapter 3	Managing Source Learning	3-1
	In This Chapter	3-1
	Source Learning Specifications	3-2
	Source Learning Defaults	3-2
	MAC Address Table Overview	3-3
	Using Static MAC Addresses	3-3
	Configuring Static MAC Addresses	3-4
	Static MAC Addresses on Link Aggregate Ports	3-4
	Using Static Multicast MAC Addresses	3-5
	Configuring Static Multicast MAC Addresses	3-5
	Static Multicast MAC Addresses on Link Aggregate Ports	3-6
	Configuring MAC Address Table Aging Time	3-7
	Configuring the Source Learning Status	3-8
	Increasing the MAC Address Table Size	3-9
	Displaying Source Learning Information	3-10
Chapter 4	Configuring VLANs	4-1
	In This Chapter	4-1
	VLAN Specifications	4-2
	VLAN Defaults	4-2
	Sample VLAN Configuration	4-3
	VLAN Management Overview	4-4
	Creating/Modifying VLANs	4-4
	Adding/Removing a VLAN	4-5
	Enabling/Disabling the VLAN Administrative Status	4-5
	Modifying the VLAN Description	4-5
	Assigning Ports to VLANs	4-6
	Changing the Default VLAN Assignment for a Port	4-6
	Using 802.1Q Tagging	4-7
	Configuring 802.1Q Tagging	4-7
	Enabling/Disabling Spanning Tree for a VLAN	4-8
	Enabling/Disabling Source Learning	4-9
	Configuring VLAN IP Interfaces	4-9
	Bridging VLANs Across Multiple Switches	4-10
	Verifying the VLAN Configuration	4-12
	Understanding Port Output	4-12
Chapter 5	Configuring High Availability VLANs	5-1
	In This Chapter	5-1
	High Availability VLANs Specifications	5-2

High Availability Default Values	5-2
Quick Steps for Creating High Availability VLANs	5-3
High Availability VLAN Overview	5-4
High Availability VLAN Operational Mode	5-4
Traffic Flows in High Availability VLAN	5-5
Configuring High Availability VLANs on a Switch	5-6
Creating and Deleting VLANs	5-6
Creating a VLAN	5-6
Deleting a VLAN	5-7
Adding and Removing Server Cluster Ports	5-7
Assigning Ports to a Server Cluster	5-7
Removing Ports from a Server Cluster	5-7
Assigning and Modifying Server Cluster Mode	5-7
Assigning L2 Mode to a Server Cluster	5-7
Assigning L3 Mode to a Server Cluster	5-7
Assigning and Removing MAC Addresses	5-8
Assigning MAC Addresses	5-8
Removing MAC Addresses	5-8
Application Examples	5-9
Example 1: Layer 2 Server Cluster	5-9
Configuration Example	5-9
Example 2: Layer 3 Server Cluster	5-11
Configuration Example	5-11
Example 3: Layer 3 Server Cluster with IP Multicast Address to Cluster (IGMP)	5-13
Configuration Example	5-14
Displaying High Availability VLAN Status	5-16
Chapter 6	
Configuring Spanning Tree Parameters	6-1
In This Chapter	6-2
Spanning Tree Specifications	6-3
Spanning Tree Bridge Parameter Defaults	6-4
Spanning Tree Port Parameter Defaults	6-4
Multiple Spanning Tree (MST) Region Defaults	6-5
Spanning Tree Overview	6-6
How the Spanning Tree Topology is Calculated	6-6
Bridge Protocol Data Units (BPDU)	6-8
Loop-guard on OmniSwitch	6-9
Topology Examples	6-11
MST General Overview	6-13
How MSTP Works	6-13
Comparing MSTP with STP and RSTP	6-16
What is a Multiple Spanning Tree Instance (MSTI)	6-16
What is a Multiple Spanning Tree Region	6-17
What is the Common Spanning Tree	6-18
What is the Internal Spanning Tree (IST) Instance	6-18

What is the Common and Internal Spanning Tree Instance	6-18
MST Configuration Overview	6-18
MST Interoperability and Migration	6-19
Migrating from Flat Mode STP/RSTP to Flat Mode MSTP	6-19
Migrating from Per-VLAN Mode to Flat Mode MSTP	6-20
Spanning Tree Operating Modes	6-21
Using Flat Spanning Tree Mode	6-21
Using Per-VLAN Spanning Tree Mode	6-22
Using Per-VLAN Spanning Tree Mode with PVST+	6-23
OmniSwitch PVST+ Interoperability	6-24
BPDU Processing in PVST+ Mode	6-25
Recommendations and Requirements for PVST+ Configurations	6-25
Using Spanning Tree Configuration Commands	6-26
Configuring STP Bridge Parameters	6-27
Selecting the Spanntree Protocol	6-28
Configuring the Bridge Priority	6-28
Configuring the Bridge Hello Time	6-29
Configuring the Bridge Max-Age Time	6-30
Configuring the Forward Delay Time for the Switch	6-30
Enabling/Disabling the VLAN BPDU Switching Status	6-31
Configuring the Path Cost Mode	6-32
Using Automatic VLAN Containment	6-32
Configuring STP Port Parameters	6-34
Enabling/Disabling Spanning Tree on a Port	6-35
Spanning Tree on Link Aggregate Ports	6-36
Enabling/Disabling Loop-guard	6-36
Configuring Port Priority	6-36
Port Priority on Link Aggregate Ports	6-37
Configuring Port Path Cost	6-37
Path Cost for Link Aggregate Ports	6-38
Configuring Port Mode	6-40
Mode for Link Aggregate Ports	6-40
Configuring Port Connection Type	6-41
Connection Type on Link Aggregate Ports	6-42
Configuring the Edge Port Status	6-42
Restricting Port Roles (Root Guard)	6-43
Restricting TCN Propagation	6-43
Limiting BPDU Transmission	6-43
Sample Spanning Tree Configuration	6-44
Example Network Overview	6-44
Example Network Configuration Steps	6-45
Sample MST Region Configuration	6-47
Sample MSTI Configuration	6-49
Verifying the Spanning Tree Configuration	6-52

Chapter 7	Configuring Shortest Path Bridging	7-1
	In This Chapter	7-2
	Shortest Path Bridging Specifications	7-3
	SPB-M Parameter Defaults	7-4
	SPB-M Interface Defaults	7-4
	SPB-M Service Defaults	7-5
	Shortest Path Bridging Overview	7-6
	SPB-M Shortest Path Trees	7-8
	Spanning Tree	7-8
	ISIS-SPB	7-9
	SPB Services	7-12
	Sample SPB-M Network Topology	7-13
	How it Works	7-14
	IP over SPBM	7-15
	VPN-Lite	7-15
	L3 VPN	7-15
	IP over SPBM Loopback	7-15
	How it Works	7-16
	Interaction With Other Features	7-18
	Backbone VLANs (VLAN Manager)	7-18
	Application Monitoring and Enforcement	7-18
	Link Aggregation	7-18
	OAM	7-19
	Quality of Service (QoS)	7-19
	Universal Network Profiles (UNP)	7-20
	Dynamic Service Access Points	7-20
	VRF	7-20
	Quick Steps for Configuring SPB-M	7-21
	Quick Steps for Configuring the SPB-M Backbone	7-21
	Quick Steps for Configuring SPB Services	7-22
	Sample Command Configuration	7-22
	SPB-M Backbone Commands	7-22
	SPB-M Service Commands	7-23
	Configuring SPB-M	7-24
	Configure the SPB-M Backbone (ISIS-SPB)	7-24
	Configure SPB-M Services	7-24
	SPB Configuration Guidelines	7-25
	ISIS-SPB	7-25
	Backbone VLANs	7-25
	Configuring BVLANS	7-26
	Assigning the Equal Cost Tree ID	7-26
	Configuring the Control BVLAN	7-27
	Configuring the Tandem Multicast Mode	7-27
	Verifying the BVLAN Configuration	7-27
	Configuring SPB Interfaces	7-28
	Verifying the SPB Interface Configuration	7-29
	Configuring Global ISIS-SPB Parameters	7-30

Configuring the System Name	7-31
Configuring the SPB Bridge Priority	7-31
Configuring the ISIS-SPB Area Address	7-31
Configuring the Shortest Path Source ID	7-31
Configuring the Control MAC Address	7-31
Configuring the Shortest Path First Wait Time	7-32
Configuring the Link State Packet Wait Time	7-33
Configuring the Overload State	7-34
Configuring Redundant Switches for Graceful Restart	7-35
Enabling/Disabling ISIS-SPB	7-35
Creating an SPB Service	7-36
Modifying Default SPB Service Parameters	7-36
Enable the Service	7-37
Deleting an SPB Service	7-38
Verifying the SPB Service Configuration	7-38
Configuring Service Access Points (SAPs)	7-39
SAP Configuration Guidelines	7-39
Configuring Service Access Ports	7-40
Creating the Service Access Point	7-42
Configuring IP over SPB	7-46
Verifying L3 VPN Configuration and Routes	7-47
IP over SPB Configuration Examples	7-47
Verifying the SPB Backbone and Services	7-54
Verifying the ISIS-SPB Backbone Configuration	7-54
Verifying the SPB Service Configuration	7-55

Chapter 8	Configuring Loopback Detection	8-1
	In This Chapter	8-1
	LBD Specifications	8-2
	LBD Defaults	8-3
	Quick Steps for Configuring LBD	8-4
	LBD Overview	8-6
	Transmission Timer	8-6
	Remote-origin LBD Overview	8-6
	Interaction With Other Features	8-8
	Spanning Tree Protocol	8-8
	Link Aggregation	8-8
	Configuring LBD	8-9
	Enabling LBD	8-9
	Enabling LBD on a Port	8-9
	Enabling Remote-origin LBD	8-9
	Enabling Remote-origin LBD on a port	8-9
	Configuring the LBD Transmission Timer	8-10
	Viewing LBD Statistics	8-10
	Recovering a Port from LBD Shutdown	8-10
	Configuring Autorecovery-timer for LBD shutdown ports	8-10

	LBD for Service Access Interface	8-10
	Enabling LBD on Service-access Interface	8-11
	LBD Packet Processing Mechanism for LBD Service Access Ports	8-11
	Sample Scenarios	8-12
	Scenario 1	8-12
	Scenario 2	8-13
	Verifying the LBD Configuration	8-14
Chapter 9	Configuring Static Link Aggregation	9-1
	In This Chapter	9-1
	Static Link Aggregation Specifications	9-2
	Static Link Aggregation Default Values	9-2
	Quick Steps for Configuring Static Link Aggregation	9-3
	Static Link Aggregation Overview	9-5
	Static Link Aggregation Operation	9-5
	Relationship to Other Features	9-5
	Configuring Static Link Aggregation Groups	9-6
	Configuring Mandatory Static Link Aggregate Parameters	9-6
	Creating and Deleting a Static Link Aggregate Group	9-7
	Creating a Static Aggregate Group	9-7
	Deleting a Static Aggregate Group	9-7
	Adding and Deleting Ports in a Static Aggregate Group	9-7
	Adding Ports to a Static Aggregate Group	9-7
	Removing Ports from a Static Aggregate Group	9-8
	Modifying Static Aggregation Group Parameters	9-9
	Modifying the Static Aggregate Group Name	9-9
	Creating a Static Aggregate Group Name	9-9
	Deleting a Static Aggregate Group Name	9-9
	Modifying the Static Aggregate Group Administrative State	9-9
	Enabling the Static Aggregate Group Administrative State	9-9
	Disabling the Static Aggregate Group Administrative State	9-9
	Application Example	9-10
	Displaying Static Link Aggregation Configuration and Statistics	9-11
Chapter 10	Configuring Dynamic Link Aggregation	10-1
	In This Chapter	10-1
	Dynamic Link Aggregation Specifications	10-2
	Dynamic Link Aggregation Default Values	10-3
	Quick Steps for Configuring Dynamic Link Aggregation	10-4
	Dynamic Link Aggregation Overview	10-6
	Dynamic Link Aggregation Operation	10-6
	Relationship to Other Features	10-8
	Configuring Dynamic Link Aggregate Groups	10-8
	Configuring Mandatory Dynamic Link Aggregate Parameters	10-9

	Creating and Deleting a Dynamic Aggregate Group	10-9
	Creating a Dynamic Aggregate Group	10-9
	Deleting a Dynamic Aggregate Group	10-10
	Configuring Ports to Join and Removing Ports in a Dynamic Aggregate Group	10-10
	Configuring Ports To Join a Dynamic Aggregate Group	10-10
	Removing Ports from a Dynamic Aggregate Group	10-11
	Modifying Dynamic Link Aggregate Group Parameters	10-12
	Modifying Dynamic Aggregate Group Parameters	10-12
	Modifying the Dynamic Aggregate Group Name	10-13
	Modifying the Dynamic Aggregate Group Administrative State	10-13
Administrative Key	Configuring and Deleting the Dynamic Aggregate Group Actor 10-14	
	Modifying the Dynamic Aggregate Group Actor System Priority	10-14
	Modifying the Dynamic Aggregate Group Actor System ID	10-15
	Modifying the Dynamic Aggregate Group Partner Administrative Key	10-15
	Modifying the Dynamic Aggregate Group Partner System Priority	10-16
	Modifying the Dynamic Aggregate Group Partner System ID	10-16
	Modifying Dynamic Link Aggregate Actor Port Parameters	10-17
	Modifying the Actor Port System Administrative State	10-17
	Modifying the Actor Port System ID	10-19
	Modifying the Actor Port System Priority	10-19
	Modifying the Actor Port Priority	10-20
	Modifying Dynamic Aggregate Partner Port Parameters	10-21
	Modifying the Partner Port System Administrative State	10-21
	Modifying the Partner Port Administrative Key	10-23
	Modifying the Partner Port System ID	10-23
	Modifying the Partner Port System Priority	10-24
	Modifying the Partner Port Administrative Status	10-24
	Modifying the Partner Port Priority	10-25
	Application Examples	10-26
	Sample Network Overview	10-26
	Link Aggregation and Spanning Tree Example	10-27
	Link Aggregation and QoS Example	10-28
	Displaying Dynamic Link Aggregation Configuration and Statistics	10-29
Chapter 11	Configuring Dual-Home Links	11-1
	In This Chapter	11-1
	Dual-Home Link Specifications	11-2
	Dual-Home Link Active-Active Defaults	11-2
	Dual-Home Link Active-Active	11-3
	DHL Active-Active Operation	11-3
	Protected VLANs	11-4
	DHL Port Types	11-4
	DHL Pre-Emption Timer	11-4
	MAC Address Flushing	11-4
	DHL Configuration Guidelines	11-6
	Configuring DHL Active-Active	11-6

	Dual-Home Link Active-Active Example	11-8
	CLI Command Sequence Example	11-9
	Recommended DHL Active-Active Topology	11-10
	Unsupported DHL Active-Active Topology (Network Loops)	11-11
	Displaying the Dual-Home Link Configuration	11-12
Chapter 12	Configuring ERP	12-1
	In This Chapter	12-1
	ERP Specifications	12-2
	ERP Defaults	12-3
	ERPV2 Defaults	12-3
	ERP Overview	12-4
	ERP and ERPv2 Terms	12-4
	ERP Timers	12-5
	ERP Basic Operation	12-6
	ERP Ring Modes	12-6
	Overlapping Protected VLANs Between ERP Rings on same Node	12-7
	ERPV2 Basic Operation	12-8
	R-APS Virtual Channel	12-9
	Revertive/Non-Revertive Mode	12-9
	Untagged Service VLAN	12-9
	Interaction With Other Features	12-10
	Multicast	12-10
	Spanning Tree	12-10
	VLAN Stacking	12-10
	Source Learning	12-10
	QoS Interface	12-10
	MVRP	12-10
	Quick Steps for Configuring ERP with Standard VLANs	12-11
	Quick Steps for Configuring ERP with VLAN Stacking	12-12
	ERP Configuration Overview and Guidelines	12-13
	Configuring an ERP Ring	12-14
	Adding VLANs to Ring Ports	12-14
	Configuring an RPL Port	12-15
	Setting the Wait-to-Restore Timer	12-15
	Setting the Guard Timer	12-15
	Configuring ERP with VLAN Stacking NNIs	12-16
	Configuring ERP Protected SVLANs	12-17
	Clearing ERP Statistics	12-17
	ERPV2 Configuration Overview and Guidelines	12-18
	Major and Sub Ring Management	12-18
	Configuration Parameters	12-18
	ERPV2 Ring Sample Configuration	12-19
	Sample Switch Configuration	12-19
	Enabling and Disabling R-APS Virtual Channel	12-20
	Disabling R-APS Virtual Channel	12-20

	Enabling or Disabling Revertive Mode	12-21
	Non-revertive Mode	12-21
	Clear Non-revertive and Revertive Mode	12-21
	Sample Ethernet Ring Protection Configuration	12-22
	Example ERP Overview	12-22
	Example ERP Configuration Steps	12-23
	Sample ERIPv2 Ring Configuration	12-24
	Example ERIPv2 Overview	12-24
	Configuring Shared Link	12-25
	Configuring Main RPL Node	12-25
	Configuring Switches in Main Ring	12-26
	Configuring Secondary RPL Node	12-26
	Configuring Switch in Sub Ring	12-26
	Verifying the ERP Configuration	12-27
Chapter 13	Configuring MVRP	13-1
	In This Chapter	13-1
	MVRP Specifications	13-2
	MVRP Defaults	13-2
	Quick Steps for Configuring MVRP	13-3
	MRP Overview	13-4
	MVRP Overview	13-4
	How MVRP Works	13-4
	Interaction With Other Features	13-6
	STP	13-6
	Configuring MVRP	13-7
	Enabling MVRP	13-7
	Configuring the Maximum Number of VLANs	13-7
	Configuring MVRP Registration	13-8
	Setting MVRP Normal Registration	13-8
	Setting MVRP Fixed Registration	13-8
	Setting MVRP Forbidden Registration	13-9
	Configuring the MVRP Applicant Mode	13-9
	Modifying MVRP Timers	13-10
	Restricting VLAN Registration	13-11
	Restricting Static VLAN Registration	13-11
	Restricting VLAN Advertisement	13-12
	Verifying the MVRP Configuration	13-13
Chapter 14	Configuring 802.1AB	14-1
	In This Chapter	14-1
	802.1AB Specifications	14-2
	802.1AB Defaults Table	14-3
	Quick Steps for Configuring 802.1AB	14-4

802.1AB Overview	14-5
Mandatory TLVs	14-5
Optional TLVs	14-6
LLDP PoE Power Negotiation	14-7
mac-phy TLV	14-7
power-via-mdi TLV	14-7
LLDP-Media Endpoint Devices	14-7
Automatic VLAN Assignment for IP Phone through LLDP MED	14-8
Multiple LLDP Agent Support	14-8
LLDP Agent Operation	14-9
LLDPDU Transmission and Reception	14-9
Aging Time	14-9
Nearest Bridge/Edge Mode	14-9
Nearest-Edge Mode Operation	14-10
Configuring 802.1AB	14-11
Configuring LLDPDU Flow	14-11
Enabling and Disabling Notification	14-11
Configuring an LLDP Network Policy	14-12
Enabling and Disabling Management TLV	14-12
Enabling and Disabling 802.1 TLV	14-13
Enabling and Disabling 802.3 TLV	14-13
Enabling and Disabling MED TLV	14-14
Enabling and Disabling Application Priority TLV	14-14
Setting the Transmit Interval	14-15
Setting the Transmit Hold Multiplier Value	14-15
Setting the Reinit Delay	14-15
Setting the Notification Interval	14-15
Verifying 802.1AB Configuration	14-16
Chapter 15 Configuring SIP Snooping	15-1
In This Chapter	15-1
SIP Snooping Specifications	15-2
SIP Snooping Defaults	15-2
Parameter Description and Values	15-3
Quick Steps for Configuring SIP Snooping	15-4
SIP Snooping Overview	15-5
Using SIP Snooping	15-6
Interoperability	15-7
SIP Snooping Configuration Guidelines	15-8
Configuring Edge Port	15-8
Configuring Trusted SIP Server	15-8
Configuring SIP Snooping TCP Ports	15-9
Configuring SIP Snooping UDP Ports	15-9
Configuring the SIP Control DSCP	15-9
Configuring SOS Calls	15-9
Configuring SOS Call DSCP	15-9
Configuring RTCP Thresholds	15-10

Configuring the Logging Threshold for the Number of Calls	15-10
Configuring Policy Rules for SIP Snooping	15-10
Policy Condition	15-10
Policy Action	15-11
Policy Rule	15-11
Unsupported Topologies	15-11
SIP Snooping Use Case	15-12
Expectations	15-12
SIP Condition	15-13
Advanced RTCP Control	15-14
SIP Snooping Limitations	15-15
Verifying the SIP Snooping Configuration	15-16
Chapter 16	
Configuring IP	16-1
In This Chapter	16-1
IP Specifications	16-3
IP Defaults	16-3
Quick Steps for Configuring IP Forwarding	16-4
IP Overview	16-5
IP Protocols	16-5
Transport Protocols	16-5
Application-Layer Protocols	16-5
Additional IP Protocols	16-6
IP Forwarding	16-7
Configuring an IP Interface	16-8
Modifying an IP Router Interface	16-9
Removing an IP Router Interface	16-9
Configuring a Loopback0 Interface	16-10
Loopback0 Address Advertisement	16-10
Configuring a BGP Peer Session with Loopback0	16-10
Configuring an IP Managed Interface	16-11
Creating a Static Route or Recursive Static Route	16-12
Creating a Recursive Static Route	16-13
Creating a Default Route	16-13
Configuring Address Resolution Protocol (ARP)	16-13
Adding a Permanent Entry to the ARP Table	16-14
Deleting a Permanent Entry from the ARP Table	16-14
Clearing a Dynamic Entry from the ARP Table	16-15
Local Proxy ARP	16-15
ARP Filtering	16-15
IP Configuration	16-17
Configuring the Router Primary Address	16-17
Configuring the Router ID	16-17
Configuring the Route Preference of a Router	16-17
Configuring the Time-to-Live (TTL) Value	16-18
Configuring Route Map Redistribution	16-18
Using Route Maps	16-18

Configuring Route Map Redistribution	16-22
Route Map Redistribution Example	16-23
IP-Directed Broadcasts	16-24
Denial of Service (DoS) Filtering	16-24
Enabling/Disabling IP Services	16-29
Managing IP	16-30
Internet Control Message Protocol (ICMP)	16-30
ICMP Control Table	16-32
ICMP Statistics Table	16-32
Using the Ping Command	16-32
Tracing an IP Route	16-33
Displaying TCP Information	16-33
Displaying UDP Information	16-34
Tunneling	16-34
Generic Routing Encapsulation	16-34
IP Encapsulation within IP	16-34
Tunneling operation	16-35
Configuring a Tunnel Interface	16-36
Verifying the IP Configuration	16-37
VRF Route Leak	16-38
Quick Steps for Configuring VRF Route Leak	16-38
Configuring VRF Route Leak	16-39
Export Routes to the GRT	16-39
Import Routes from the GRT	16-39
Configure Route Preference for Imported Routes	16-40
Redistribute Imported Routes	16-40
Verifying VRF Route Leak Configuration	16-40
Chapter 17	
Configuring Multiple VRF	17-1
In This Chapter	17-1
VRF Specifications	17-2
VRF Defaults	17-2
Quick Steps for Configuring Multiple VRF	17-3
Multiple VRF Overview	17-6
VRF Profiles	17-8
Using the VRF Command Line Interface	17-8
ASCII-File-Only Syntax	17-9
Management VRF	17-9
VRF Interaction With Other Features	17-11
AAA RADIUS/TACACS+/LDAP Servers	17-12
BGPv4	17-12
IP-IP and GRE Tunnels	17-12
Management Applications (Telnet and SSH)	17-12
FTP	17-12
NTP	17-13
WebView	17-13
Syslog Server	17-13

Quality of Service (QoS)	17-13
VRF Policies	17-13
SNMP	17-13
VLANs	17-14
UDP/DHCP Relay	17-14
Configuring VRF Instances	17-15
Configuring the VRF Profile	17-15
Selecting a VRF Instance	17-16
Assigning IP Interfaces to a VRF Instance	17-17
Configuring Routing Protocols for a Specific VRF Instance	17-17
Removing a VRF Instance	17-17
Verifying the VRF Configuration	17-18

Chapter 18

Configuring IPv6	18-1
In This Chapter	18-1
IPv6 Specifications	18-2
IPv6 Defaults	18-4
Quick Steps for Configuring IPv6 Routing	18-5
IPv6 Overview	18-6
IPv6 Addressing	18-7
IPv6 Address Notation	18-8
IPv6 Address Prefix Notation	18-8
Auto-configuration of IPv6 Addresses	18-9
Globally Unique Local IPv6 Unicast Addresses	18-10
Tunneling IPv6 over IPv4	18-11
6to4 Tunnels	18-11
Configured Tunnels	18-13
Local Proxy Neighbor Discovery (LPND)	18-13
Router Advertisement (RA) Filtering	18-13
Neighbor Cache Limit	18-13
Neighbor Unreachability Detection (NUD)	18-14
Configuring an IPv6 Interface	18-15
Configuring a Unique Local IPv6 Unicast Address	18-16
Modifying an IPv6 Interface	18-16
Removing an IPv6 Interface	18-16
Assigning IPv6 Addresses	18-17
Removing an IPv6 Address	18-18
Configuring IPv6 Tunnel Interfaces	18-19
Creating an IPv6 Static Route	18-20
Configuring the Route Preference of a Router	18-21
Configuring Route Map Redistribution	18-22
Using Route Maps	18-22
Configuring Route Map Redistribution	18-26
Route Map Redistribution Example	18-27
Configuring LPND	18-27

	Configuring Neighbor Cache Limit	18-27
	Configuring NUD	18-28
	Configuring RA Filtering	18-29
	Quick Steps for Configuring DHCPv6 Relay	18-29
	DHCPv6 Relay Overview	18-30
	DHCPv6 Relay Interface	18-30
	DHCPv6 Relay Messages	18-30
	Relay-Forward Messages	18-30
	Relay-Reply Messages	18-30
	Configuring DHCPv6 Relay	18-31
	Enabling the DHCPv6 Relay Per-VRF	18-31
	Configuring the DHCPv6 Relay Interface	18-31
	Configuring the DHCPv6 Relay Destination	18-31
	Displaying the DHCPv6 Relay Configuration	18-31
	Verifying the IPv6 Configuration	18-32
Chapter 19	Configuring IPsec	19-1
	In This Chapter	19-1
	IPsec Specifications	19-2
	IPsec Defaults	19-2
	Quick Steps for Configuring an IPsec AH Policy	19-3
	Quick Steps for Configuring an IPsec Discard Policy	19-4
	IPsec Overview	19-5
	Encapsulating Security Payload (ESP)	19-6
	Encryption Algorithms	19-6
	Authentication Header (AH)	19-7
	Authentication Algorithms	19-7
	IPsec on the OmniSwitch	19-8
	Securing Traffic Using IPsec	19-8
	Master Security Key	19-8
	IPsec Policy	19-8
	Security Association (SA)	19-9
	Discarding Traffic using IPsec	19-9
	Configuring IPsec on the OmniSwitch	19-10
	Configuring an IPsec Master Key	19-10
	Configuring an IPsec Policy	19-11
	Enabling and Disabling a Policy	19-12
	Assigning a Priority to a Policy	19-12
	Assigning an Action to a Policy	19-13
	Configuring the Protocol for a Policy	19-13
	Verifying a Policy	19-13
	Configuring an IPsec Rule	19-14
	Configuring an IPsec SA	19-15
	Configuring ESP or AH	19-15

	Verifying IPsec SA	19-16
	Configuring IPsec SA Keys	19-16
	Additional Examples	19-19
	Configuring ESP	19-19
	Discarding RIPng Packets	19-21
	Verifying the IPsec Configuration	19-22
Chapter 20	Configuring RIP	20-1
	In This Chapter	20-1
	RIP Specifications	20-2
	RIP Defaults	20-2
	Quick Steps for Configuring RIP Routing	20-3
	RIP Overview	20-4
	RIP Version 2	20-5
	RIP Routing	20-6
	Loading RIP	20-6
	Enabling RIP	20-7
	Creating a RIP Interface	20-7
	Enabling a RIP Interface	20-7
	Configuring the RIP Interface Send Option	20-7
	Configuring the RIP Interface Receive Option	20-8
	Configuring the RIP Interface Metric	20-8
	Configuring the RIP Interface Route Tag	20-9
	RIP Options	20-9
	Configuring the RIP Forced Hold-Down Interval	20-9
	Configuring the RIP Update Interval	20-9
	Configuring the RIP Invalid Timer	20-10
	Configuring the RIP Garbage Timer	20-10
	Configuring the RIP Hold-Down Timer	20-10
	Reducing the Frequency of RIP Routing Updates	20-10
	Enabling a RIP Host Route	20-11
	Configuring Redistribution	20-12
	Using Route Maps	20-12
	Configuring Route Map Redistribution	20-16
	Route Map Redistribution Example	20-17
	RIP Security	20-18
	Configuring Authentication Type	20-18
	Configuring Passwords	20-18
	Verifying the RIP Configuration	20-19
Chapter 21	Configuring BFD	21-1
	In This Chapter	21-1
	BFD Specifications	21-2
	BFD Defaults	21-2

Quick Steps for Configuring BFD	21-3
Quick Steps for Configuring BFD Support for Layer 3 Protocols	21-5
Configuring BFD Support for OSPF	21-5
Configuring BFD Support for BGP	21-6
Configuring BFD Support for VRRP Track Policies	21-6
Configuring BFD Support for Static Routes	21-6
BFD Overview	21-8
Benefits of Using BFD For Failure Detection	21-8
How the BFD Protocol Works	21-8
Operational Mode and Echo Function	21-9
BFD Packet Formats	21-9
BFD Control Packets	21-9
BFD Echo Packets	21-10
BFD Session Establishment	21-10
Demultiplexing	21-11
BFD Timer Negotiation	21-11
Configuring BFD	21-12
Configuring BFD Session Parameters	21-12
Configuring a BFD Session	21-12
Configuring the BFD Transmit Time interval	21-13
Configuring the BFD Receive Time Interval	21-13
Configuring the BFD Echo Interval	21-13
Configuring the BFD Multiplier	21-14
Enabling or Disabling BFD Status	21-14
Configuring BFD Support for Layer 3 Protocols	21-15
Configuring BFD Support for OSPF	21-16
Configuring BFD Support for BGP	21-18
Configuring BFD Support for VRRP Tracking	21-20
Configuring BFD Support for Static Routes	21-22
BFD Application Example	21-24
Example Network Overview	21-24
Step 1: Prepare the Routers	21-25
Step 2: Enable OSPF	21-26
Step 3: Create the OSPF Area	21-26
Step 4: Configure OSPF Interfaces	21-27
Step 5: (Optional) Configure BFD Interfaces	21-27
Step 6: (Optional) Configure Global BFD Parameters	21-28
Step 7: Enable BFD and register OSPF with BFD	21-28
Step 8: Examine the Network	21-29
Verifying the BFD Configuration	21-29

Chapter 22

Configuring DHCP Relay	22-1
In This Chapter	22-1
DHCP Relay Specifications	22-2
DHCP Relay Defaults	22-3
Quick Steps for Setting Up DHCP Relay	22-4
DHCP Relay Overview	22-5

DHCP	22-5
DHCP and the OmniSwitch	22-6
External DHCP Relay Application	22-7
Internal DHCP Relay	22-8
DHCP Relay Implementation	22-9
Global DHCP	22-9
Setting the IP Address	22-9
Per-VLAN DHCP	22-9
Identifying the VLAN	22-9
Configuring BOOTP/DHCP Relay Parameters	22-10
Setting the Forward Delay	22-10
Setting Maximum Hops	22-11
Setting the Relay Forwarding Option	22-11
Using Automatic IP Configuration	22-12
Enabling Automatic IP Configuration	22-12
Configuring UDP Port Relay	22-13
Enabling/Disabling UDP Port Relay	22-13
Specifying a Forwarding VLAN	22-14
How the Relay Agent Processes DHCP Packets from the Client	22-15
How the Relay Agent Processes DHCP Packets from the Server	22-15
Configuring DHCP Security Features	22-16
Using the Relay Agent Information Option (Option-82)	22-16
How the Relay Agent Processes DHCP Packets from the Client	22-17
How the Relay Agent Processes DHCP Packets from the Server	22-17
Enabling the Relay Agent Information Option-82	22-18
Configuring a Relay Agent Information Option-82 Policy	22-18
Using DHCP Snooping	22-19
DHCP Snooping Configuration Guidelines	22-20
Enabling DHCP Snooping	22-20
Configuring the Port Trust Mode	22-22
Bypassing the Option-82 Check on Untrusted Ports	22-22
Configuring IP Source Filtering	22-23
Configuring the DHCP Snooping Binding Table	22-23
Layer 2 DHCP Snooping	22-25
Verifying the DHCP Relay Configuration	22-26
Chapter 23 Configuring an Internal DHCP Server	23-1
In This Chapter	23-1
DHCP Server Specifications	23-2
DHCP Server Default Values	23-2
Quick Steps to Configure Internal DHCP Server	23-3
DHCP Server Overview	23-5
The DHCP process	23-5
Internal DHCP Server on OmniSwitch	23-5
VitalQIP Server	23-5
OmniSwitch DHCP Server Management	23-5
VitalQIP Message Service	23-6

	VitalQIP Active Lease Service	23-6
	Interaction With Other Features	23-6
	Virtual Router Forwarding (VRF)	23-6
	BootP/UDP Relay	23-6
	IP Interfaces	23-6
	VitalQIP Server	23-6
	Configuring DHCP Server on OmniSwitch	23-7
	DHCP Template files	23-7
	Policy file	23-7
	DHCP Configuration Files	23-8
	dhcpd(v6).conf File	23-9
	dhcpd(v6).conf.lastgood File	23-11
	DHCP Server Database file	23-11
	DHCP Server Application Example	23-12
	Verifying the DHCP Server Configuration	23-14
	Configuration File Parameters and Syntax	23-15
	Policy File Parameters and Syntax	23-31
Chapter 24	Configuring VRRP	24-1
	In This Chapter	24-1
	VRRP Specifications	24-3
	VRRP Defaults	24-3
	Quick Steps for Creating a Virtual Router	24-5
	VRRP Overview	24-6
	Why Use VRRP?	24-7
	Definition of a Virtual Router	24-7
	VRRP MAC Addresses	24-8
	ARP Requests	24-8
	ICMP Redirects	24-8
	VRRP Startup Delay	24-9
	VRRP Tracking	24-9
	Configuring Collective Management Functionality	24-9
	Interaction With Other Features	24-9
	VRRP Configuration Overview	24-10
	Basic Virtual Router Configuration	24-10
	Creating/Deleting a Virtual Router	24-10
	Specifying an IP Address for a Virtual Router	24-11
	Configuring the Advertisement Interval	24-12
	Configuring Virtual Router Priority	24-12
	Setting Preemption for Virtual Routers	24-13
	Enabling/Disabling a Virtual Router	24-13
	Setting VRRP Traps	24-14
	Setting VRRP Startup Delay	24-14

Configuring Collective Management Functionality	24-14
Changing Default Parameter Values for all Virtual Routers	24-14
Changing Default Parameter Values for a Virtual Router Group	24-16
Verifying the VRRP Configuration	24-18
VRRPv3 Configuration Overview	24-19
Basic VRRPv3 Virtual Router Configuration	24-19
Creating/Deleting a VRRPv3 Virtual Router	24-19
Specifying an IPv6 Address for a VRRPv3 Virtual Router	24-20
Configuring the VRRPv3 Advertisement Interval	24-21
Configuring the VRRPv3 Virtual Router Priority	24-21
Setting Preemption for VRRPv3 Virtual Routers	24-22
Enabling/Disabling a VRRPv3 Virtual Router	24-23
Setting VRRPv3 Traps	24-23
Verifying the VRRPv3 Configuration	24-24
Creating Tracking Policies	24-25
Associating a Tracking Policy with a VRRPv2/VRRPv3 Virtual Router	24-25
VRRP Application Example	24-26
VRRP Tracking Example	24-27
VRRPv3 Application Example	24-29
VRRPv3 Tracking Example	24-30
Chapter 25	
Configuring Server Load Balancing	25-1
In This Chapter	25-1
Server Load Balancing Specifications	25-2
Server Load Balancing Default Values	25-3
Quick Steps for Configuring Server Load Balancing	25-4
Quick Steps for Configuring a QoS Policy Condition Cluster	25-5
Server Load Balancing Overview	25-7
Server Load Balancing Cluster Identification	25-7
Server Load Balancing Cluster Modes	25-7
Server Load Balancing Example	25-8
Weighted Round Robin Distribution Algorithm	25-9
Server Health Monitoring	25-10
Configuring Server Load Balancing on a Switch	25-11
Enabling and Disabling Server Load Balancing	25-11
Enabling SLB	25-11
Disabling SLB	25-11
Configuring and Deleting SLB Clusters	25-12
Configuring an SLB Cluster with a VIP Address	25-12
Configuring an SLB Cluster with a QoS Policy Condition	25-12
Automatic Configuration of SLB Policy Rules	25-13
Deleting an SLB Cluster	25-14
Assigning Servers to and Removing Servers from a Cluster	25-14
Assigning a Server to an SLB Cluster	25-14
Removing a Server from an SLB Cluster	25-14

Modifying Optional Parameters	25-15
Modifying the Ping Period	25-15
Modifying the Ping Timeout	25-15
Modifying the Ping Retries	25-16
Modifying the Relative Weight of a Physical Server	25-16
Configuring a Server in an SLB Cluster as a Backup Server	25-16
Taking Clusters and Servers On/Off Line	25-17
Taking a Cluster On/Off Line	25-17
Bringing an SLB Cluster On Line	25-17
Taking an SLB Cluster Off Line	25-17
Taking a Server On/Off Line	25-17
Bringing a Server On Line	25-17
Taking a Server Off Line	25-18
Configuring SLB Probes	25-18
Creating SLB Probes	25-18
Deleting SLB Probes	25-18
Associating a Probe with a Cluster	25-19
Associating a Probe with a Server	25-19
Modifying SLB Probes	25-19
Modifying the Probe Timeout	25-19
Modifying the Probe Period	25-19
Modifying the Probe TCP/UDP Port	25-20
Modifying the Probe Retries	25-20
Configuring a Probe User Name	25-20
Configuring a Probe Password	25-20
Configuring a Probe URL	25-21
Modifying the Probe Status	25-21
Configuring a Probe Send	25-21
Configuring a Probe Expect	25-21
Displaying Server Load Balancing Status and Statistics	25-22
Chapter 26 Configuring IP Multicast Switching	26-1
In This Chapter	26-1
IPMS Specifications	26-2
IPMSv6 Specifications	26-3
IPMS Default Values	26-3
IPMSv6 Default Values	26-5
IPMS Overview	26-6
IPMS Example	26-6
Reserved IP Multicast Addresses	26-7
IP Multicast Routing	26-7
PIM	26-8
DVMRP	26-8
IGMP Version 3	26-8
Configuring IPMS on a Switch	26-9
Enabling and Disabling IP Multicast Status	26-9
Enabling IP Multicast Status	26-9

Disabling IP Multicast Status	26-9
Enabling and Disabling IGMP Querier-forwarding	26-10
Enabling the IGMP Querier-forwarding	26-10
Disabling the IGMP Querier-forwarding	26-10
Configuring and Restoring the IGMP Version	26-10
Configuring the IGMP Version	26-11
Restoring the IGMP Version	26-11
Configuring and Removing an IGMP Static Neighbor	26-11
Configuring an IGMP Static Neighbor	26-11
Removing an IGMP Static Neighbor	26-12
Configuring and Removing an IGMP Static Querier	26-12
Configuring an IGMP Static Querier	26-12
Removing an IGMP Static Querier	26-12
Configuring and Removing an IGMP Static Group	26-12
Configuring an IGMP Static Group	26-12
Removing an IGMP Static Group	26-12
Initial Multicast Packet Buffering	26-13
Enabling Packet Buffering	26-13
Disabling Packet Buffering	26-14
Modifying IPMS Parameters	26-15
Modifying the IGMP Query Interval	26-15
Configuring the IGMP Query Interval	26-15
Restoring the IGMP Query Interval	26-15
Modifying the IGMP Last Member Query Interval	26-15
Configuring the IGMP Last Member Query Interval	26-16
Restoring the IGMP Last Member Query Interval	26-16
Modifying the IGMP Query Response Interval	26-16
Configuring the IGMP Query Response Interval	26-16
Restoring the IGMP Query Response Interval	26-17
Modifying the IGMP Router Timeout	26-17
Configuring the IGMP Router Timeout	26-17
Restoring the IGMP Router Timeout	26-17
Modifying the Source Timeout	26-18
Configuring the Source Timeout	26-18
Restoring the Source Timeout	26-18
Enabling and Disabling IGMP Querying	26-18
Enabling the IGMP Querying	26-19
Disabling the IGMP Querying	26-19
Modifying the IGMP Robustness Variable	26-19
Configuring the IGMP Robustness Variable	26-19
Restoring the IGMP Robustness Variable	26-20
Enabling and Disabling the IGMP Spoofing	26-20
Enabling the IGMP Spoofing	26-20
Disabling the IGMP Spoofing	26-20
Enabling and Disabling the IGMP Zapping	26-21
Enabling the IGMP Zapping	26-21
Disabling the IGMP Zapping	26-21
Limiting IGMP Multicast Groups	26-22
Setting the IGMP Group Limit	26-22
IPMSv6 Overview	26-23
IPMSv6 Example	26-23

Reserved IPv6 Multicast Addresses	26-24
MLD Version 2	26-24
Configuring IPMSv6 on a Switch	26-25
Enabling and Disabling IPv6 Multicast Status	26-25
Enabling IPv6 Multicast Status	26-25
Disabling IPv6 Multicast Status	26-25
Enabling and Disabling MLD Querier-forwarding	26-26
Enabling the MLD Querier-forwarding	26-26
Disabling the MLD Querier-forwarding	26-26
Configuring and Restoring the MLD Version	26-26
Configuring the MLD Version 2	26-26
Restoring the MLD Version 1	26-27
Configuring and Removing an MLD Static Neighbor	26-27
Configuring an MLD Static Neighbor	26-27
Removing an MLD Static Neighbor	26-27
Configuring and Removing an MLD Static Querier	26-27
Configuring an MLD Static Querier	26-28
Removing an MLD Static Querier	26-28
Configuring and Removing an MLD Static Group	26-28
Configuring an MLD Static Group	26-28
Removing an MLD Static Group	26-28
Modifying IPMSv6 Parameters	26-29
Modifying the MLD Query Interval	26-29
Configuring the MLD Query Interval	26-29
Restoring the MLD Query Interval	26-29
Modifying the MLD Last Member Query Interval	26-29
Configuring the MLD Last Member Query Interval	26-29
Restoring the MLD Last Member Query Interval	26-30
Modifying the MLD Query Response Interval	26-30
Configuring the MLD Query Response Interval	26-30
Restoring the MLD Query Response Interval	26-30
Modifying the MLD Router Timeout	26-31
Configuring the MLD Router Timeout	26-31
Restoring the MLD Router Timeout	26-31
Modifying the Source Timeout	26-31
Configuring the Source Timeout	26-32
Restoring the Source Timeout	26-32
Enabling and Disabling the MLD Querying	26-32
Enabling the MLD Querying	26-32
Disabling the MLD Querying	26-32
Modifying the MLD Robustness Variable	26-33
Configuring the MLD Robustness Variable	26-33
Restoring the MLD Robustness Variable	26-33
Enabling and Disabling the MLD Spoofing	26-34
Enabling the MLD Spoofing	26-34
Disabling the MLD Spoofing	26-34
Enabling and Disabling the MLD Zapping	26-35
Enabling the MLD Zapping	26-35
Disabling the MLD Zapping	26-35
Limiting MLD Multicast Groups	26-35
Setting the MLD Group Limit	26-36

	IPMS Application Example	26-37
	IPMSv6 Application Example	26-39
	Displaying IPMS Configurations and Statistics	26-41
	Displaying IPMSv6 Configurations and Statistics	26-42
Chapter 27	Configuring QoS	27-1
	In This Chapter	27-1
	QoS Specifications	27-2
	QoS General Overview	27-3
	Classification	27-4
	How Traffic is Classified and Marked	27-4
	Classifying Bridged Traffic as Layer 3	27-5
	Automatic QoS Prioritization for IP Phone Traffic	27-5
	Prioritizing CPU Packets	27-7
	Configuring Trusted Ports	27-7
	Using Trusted Ports With Policies	27-8
	Congestion Management	27-9
	Queue Sets	27-9
	QSet Profiles	27-10
	Multicast and Unicast Traffic Distribution	27-12
	Traffic Policing and Shaping	27-13
	Policing	27-13
	Shaping	27-13
	Tri-Color Marking	27-14
	Configuring Tri-Color Marking	27-15
	Setting the DEI Bit	27-16
	Configuring Policy Bandwidth Policing	27-17
	Port Groups and Maximum Bandwidth	27-17
	Per-Port Rate Limiting with Source Port Groups	27-19
	Configuring Port Bandwidth Shaping	27-20
	QoS Policy Overview	27-21
	How Policies Are Used	27-21
	Policy Lists	27-22
	Interaction With Other Features	27-22
	Valid Policies	27-22
	Policy Conditions	27-23
	Policy Actions	27-24
	Condition and Action Combinations	27-25
	QoS Defaults	27-26
	Global QoS Defaults	27-26
	QoS Port Defaults	27-27
	Queue Management Defaults	27-27
	Queue Management Defaults	27-27
	Policy Rule Defaults	27-28
	Policy Action Defaults	27-29
	Default (Built-in) Policies	27-29

Configuring QoS	27-30
Configuring Global QoS Parameters	27-31
Enabling/Disabling QoS	27-31
Using the QoS Log	27-31
What Kind of Information Is Logged	27-31
Number of Lines in the QoS Log	27-32
Log Detail Level	27-32
Forwarding Log Events	27-32
Forwarding Log Events to the Console	27-33
Displaying the QoS Log	27-33
Clearing the QoS Log	27-34
Setting the Statistics Interval	27-34
Returning the Global Configuration to Defaults	27-34
Verifying Global Settings	27-34
Creating Policies	27-35
Quick Steps for Creating Policies	27-35
ASCII-File-Only Syntax	27-36
Creating Policy Conditions	27-36
Removing Condition Parameters	27-37
Deleting Policy Conditions	27-37
Creating Policy Actions	27-38
Removing Action Parameters	27-38
Deleting a Policy Action	27-38
Creating Policy Rules	27-39
Configuring a Rule Validity Period	27-39
Disabling Rules	27-40
Rule Precedence	27-40
Saving Rules	27-41
Logging Rules	27-41
Deleting Rules	27-41
Creating Policy Lists	27-42
Guidelines for Configuring Policy Lists	27-43
Using the Default Policy List	27-43
Verifying Policy Configuration	27-44
Using Condition Groups in Policies	27-45
Sample Group Configuration	27-45
Creating Network Groups	27-46
Creating Services	27-47
Creating Service Groups	27-48
Creating MAC Groups	27-49
Creating Port Groups	27-50
Verifying Condition Group Configuration	27-51
Using Map Groups	27-52
Sample Map Group Configuration	27-52
How Map Groups Work	27-53
Creating Map Groups	27-53
Verifying Map Group Configuration	27-54

Using Access Control Lists	27-55
Layer 2 ACLs	27-55
Layer 2 ACL: Example 1	27-55
Layer 2 ACL: Example 2	27-56
Layer 3 ACLs	27-57
Layer 3 ACL: Example 1	27-57
Layer 3 ACL: Example 2	27-57
IPv6 ACLs	27-58
Multicast Filtering ACLs	27-58
Using ACL Security Features	27-59
Configuring a UserPorts Group	27-60
Configuring ICMP Drop Rules	27-61
Configuring TCP Connection Rules	27-61
Applying the Configuration	27-63
Deleting the Pending Configuration	27-63
Flushing the Configuration	27-64
Interaction With LDAP Policies	27-65
Verifying the Applied Policy Configuration	27-65
Policy Applications	27-66
Basic QoS Policies	27-66
Basic Commands	27-67
Traffic Prioritization Example	27-67
Bandwidth Policing Example	27-67
Redirection Policies	27-68
Policy Based Mirroring	27-69
ICMP Policy Example	27-69
802.1p and ToS/DSCP Marking and Mapping	27-70
Policy Based Routing	27-71
Non-Contiguous Masks	27-73
Chapter 28	
Managing Policy Servers	28-1
In This Chapter	28-1
Policy Server Specifications	28-2
Policy Server Defaults	28-2
Policy Server Overview	28-3
Installing the LDAP Policy Server	28-3
Modifying Policy Servers	28-4
Modifying LDAP Policy Server Parameters	28-4
Disabling the Policy Server From Downloading Policies	28-4
Modifying the Port Number	28-5
Modifying the Policy Server Username and Password	28-5
Modifying the Searchbase	28-5
Configuring a Secure Socket Layer for a Policy Server	28-6
Loading Policies From an LDAP Server	28-6
Removing LDAP Policies From the Switch	28-6
Interaction With CLI Policies	28-7
Verifying the Policy Server Configuration	28-7

Chapter 29	Managing Authentication Servers	29-1
	In This Chapter	29-1
	Authentication Server Specifications	29-2
	Server Defaults	29-3
	RADIUS Authentication Servers	29-3
	TACACS+ Authentication Servers	29-3
	LDAP Authentication Servers	29-3
	Quick Steps For Configuring Authentication Servers	29-4
	Server Overview	29-5
	Backup Authentication Servers	29-5
	Authenticated Switch Access	29-5
	RADIUS Servers	29-7
	RADIUS Server Attributes	29-7
	Standard Attributes	29-7
	Vendor-Specific Attributes for RADIUS	29-9
	RADIUS Accounting Server Attributes	29-10
	Configuring the RADIUS Client	29-11
	TACACS+ Server	29-12
	TACACS+ Client Limitations	29-12
	Configuring the TACACS+ Client	29-13
	LDAP Servers	29-14
	Setting Up the LDAP Authentication Server	29-14
	LDAP Server Details	29-15
	LDIF File Structure	29-15
	Common Entries	29-15
	Directory Entries	29-16
	Directory Searches	29-17
	Retrieving Directory Search Results	29-17
	Directory Modifications	29-17
	Directory Compare and Sort	29-18
	The LDAP URL	29-18
	Password Policies and Directory Servers	29-19
	Directory Server Schema for LDAP Authentication	29-20
	Vendor-Specific Attributes for LDAP Servers	29-20
	LDAP Accounting Attributes	29-22
	Dynamic Logging	29-23
	Configuring the LDAP Authentication Client	29-25
	Creating an LDAP Authentication Server	29-25
	Modifying an LDAP Authentication Server	29-25
	Setting Up SSL for an LDAP Authentication Server	29-25
	Removing an LDAP Authentication Server	29-26
	Verifying the Authentication Server Configuration	29-26
Chapter 30	Configuring Universal Network Profiles	30-1
	In This Chapter	30-2
	UNP Specifications	30-2

UNP Defaults	30-3
UNP Port Configuration Defaults	30-3
UNP Global Configuration Defaults	30-4
UNP Profile Defaults	30-4
UNP Edge Profile Defaults	30-4
UNP VLAN Profile Defaults	30-5
UNP SPB Service Profile Defaults	30-6
Quick Steps for Configuring UNP	30-7
Quick Steps for Configuring Profiles	30-7
Quick Steps for Configuring Edge Profiles	30-7
Quick Steps for Configuring VLAN Profiles	30-9
Quick Steps for Configuring SPB Profiles	30-10
Quick Steps for Configuring Global UNP Parameters	30-11
Quick Steps for Configuring UNP Port Parameters	30-12
Quick Steps for Configuring UNP Classification Rules	30-16
Quick Steps for Configuring Binding Rules	30-17
Quick Steps for Configuring QoS Policy Lists	30-18
UNP Overview	30-20
Profile Types	30-20
UNP Dynamic VLANs	30-22
Dynamic VLAN Profiles	30-22
SPB Service Access Point	30-23
UNP Port Types	30-24
UNP Port Domains	30-24
Device Authentication and Classification	30-25
UNP Classification Rules	30-25
UNP Rule Types	30-26
How it Works	30-28
Interaction With Other Features	30-29
Access Guardian	30-29
Learned Port Security	30-29
Quality of Service (QoS)	30-30
UNP Port Interaction with Other Features	30-31
UNP Configuration Overview	30-32
Profile Configuration Tasks	30-32
Port Configuration Tasks	30-32
Configuring UNP Port-Based Access Control	30-33
Enabling Authentication for the Switch	30-33
Configuring an Authentication Server Down UNP	30-34
Enabling UNP on Ports	30-34
Configuring UNP Port Parameters	30-35
Using Edge Port Templates	30-37
Configuring 802.1x Authentication Bypass	30-38
Configuring UNP Port Bandwidth	30-40
Configuring UNP Port Domains	30-42
Configuring Profiles	30-43
Configuring a UNP Edge Profile	30-43
Configuring a UNP VLAN Profile	30-45
Configuring a UNP SPB Profile	30-48

Configuring QoS Policy Lists	30-50
Configuring UNP Classification Rules	30-51
Configuring Classification Rules for UNP Port Domains	30-51
Configuring Binding Rules for UNP Edge Profiles	30-52
Configuring Extended Classification Rules for UNP Edge Profiles	30-53
UNP Application Example	30-54
UNP Classification	30-54
UNP CLI Configuration Example	30-55
Verifying the UNP Configuration	30-57
Chapter 31	
Configuring Access Guardian	31-1
In This Chapter	31-2
Access Guardian Specifications	31-3
Access Guardian Defaults	31-4
Access Guardian Global Configuration Defaults	31-4
Access Guardian Profile Defaults	31-4
UNP Edge Profile Defaults	31-4
UNP VLAN Profile Defaults	31-5
UNP SPB Service Profile Defaults	31-6
Access Guardian UNP Port Defaults	31-6
Access Guardian Global AAA Parameter Defaults	31-8
Access Guardian AAA Profile Defaults	31-8
Access Guardian Captive Portal Defaults	31-9
Access Guardian Captive Portal Profile Defaults	31-10
Access Guardian QMR Defaults	31-10
Access Guardian Overview	31-11
Device Authentication	31-12
Device Classification	31-13
Role-based Access	31-13
Built-in Restricted Roles	31-14
User-Defined Roles	31-14
UNP Profiles	31-15
UNP Classification Rules	31-17
UNP Rule Types	31-17
Interaction With Other Features	31-20
OmniSwitch Bring Your Own Devices (BYOD)	31-20
Authentication, Authorization, and Accounting (AAA)	31-20
Learned Port Security	31-20
Quality of Service (QoS)	31-21
Universal Network Profile (UNP)	31-21
Configuring Port-Based Network Access Control	31-23
Setting Authentication Parameters for the Switch	31-24
Accounting Servers	31-24
Configuring Authentication Session Parameters	31-25
Using AAA Configuration Profiles	31-26
Configuring an Authentication Server Down UNP	31-27
Configuring UNP Port-Based Functionality	31-27
Configuring UNP Port Parameters	31-28

Using Edge Port Templates	31-30
Configuring 802.1x Authentication Bypass	31-31
Configuring UNP Port Bandwidth	31-33
Configuring UNP Port Domains	31-34
Configuring UNP Profiles	31-35
Configuring a UNP Edge Profile	31-35
Configuring a UNP VLAN Profile	31-38
Configuring a UNP SPB Profile	31-41
Configuring QoS Policy Lists	31-43
Dynamically Changing the Policy List Assignment (User Role)	31-43
Configuring UNP Classification Rules	31-45
Configuring Classification Rules for UNP Port Domains	31-45
Configuring Binding Rules for UNP Edge Profiles	31-46
Configuring Extended Classification Rules for UNP Edge Profiles	31-47
Using Captive Portal Authentication	31-48
Configuration Tasks and Guidelines	31-49
Quick Steps for Configuring Captive Portal Authentication	31-50
Verifying the Captive Portal Setup	31-50
Using Captive Portal Configuration Profiles	31-51
Configuring Captive Portal Profiles	31-51
Replacing the Captive Portal Certificate	31-52
Customizing Captive Portal Web Pages	31-52
Authenticating with Captive Portal	31-54
Logging Into the Network with Captive Portal	31-54
Logging Off the Network with Captive Portal	31-55
Using Quarantine Manager and Remediation	31-56
Access Guardian Application Examples	31-58
Application Example 1: Classification (Port Mobility)	31-59
How it Works	31-59
Edge Port Template Example	31-60
Application Example 2: 802.1X Authentication	31-60
How it Works	31-61
AAA Profile Example	31-61
Application Example 3: Internal Captive Portal Authentication	31-62
Network Configuration for Captive Portal Support	31-62
OmniSwitch Configuration for Captive Portal Support	31-62
How it Works	31-64
Application Example 4: Supplicant/Non-supplicant with Captive Portal Authentication	31-64
How it Works	31-66
Application Example 5: IP Phone (LLDP Network Policy TLV/Mobile Tag)	31-67
How it Works	31-68
Application Example 6: Restricted Role (Policy List) Assignment	31-69
UNP Edge Profile - Time Policy	31-70
UNP Edge Profile - Location Policy	31-71
Verifying Access Guardian Users	31-72
Logging Users Out of the Network	31-75
Verifying the Access Guardian Configuration	31-76

Bring Your Own Devices (BYOD) Overview	31-77
Key Components of a BYOD Solution	31-78
ClearPass Policy Manager	31-79
Configuring OmniSwitch Interaction with the CPPM	31-85
Configuring the CPPM server as an AAA RADIUS Server	31-85
Configuring UNP Edge Profiles	31-86
Configuring Redirection with Dynamic URLs	31-86
Configuring UNP Port Authentication	31-87
Configuring Port Bounce	31-87
Configuring the Pause Timer	31-87
BYOD Authentication Process Overview	31-88
Authentication for Registered Devices (802.1x)	31-88
Authentication for Network Devices (MAC Authentication)	31-88
Authentication for Guest Devices and Employee Onboarding	31-88
Using the Multicast Domain Name System	31-89
Quick Steps for Configuring mDNS	31-89
mDNS Work Flow	31-90
Disabling mDNS on the Switch	31-90
Verifying the mDNS Configuration	31-90
Using the Simple Service Discovery Protocol	31-91
How SSDP Relay Works	31-91
Configuring SSDP Tunnel Relay	31-92
Application Example 1: Wired DNLA-Capable Client	31-93
Application Example 2: Wireless DNLA-Capable Clients	31-93
BYOD Application Examples	31-95
Employee Registered Device — 802.1x Authentication	31-95
IP Phone — MAC Authentication	31-95
Guest Device —MAC Authentication with Guest Login	31-95
Application Example 1: 802.1x — OmniSwitch Configuration	31-96
Application Example 1: 802.1x — ClearPass Configuration	31-97
Application Example 2: IP Phone — OmniSwitch Configuration	31-102
Application Example 2: IP Phone — ClearPass Configuration	31-103
Application Example 3: Guest — OmniSwitch Configuration	31-106
Application Example 3: Guest — ClearPass Configuration	31-107
Verifying BYOD Configuration	31-112

Chapter 32	Configuring Application Monitoring and Enforcement	32-1
	In This Chapter	32-2
	AppMon Specifications	32-3
	AppMon Defaults	32-4
	Application Monitoring and Enforcement Overview	32-5
	Application Monitoring	32-5
	Application Enforcement	32-6
	Quick Steps for Configuring AppMon	32-8
	Application Signature File/Kit	32-9
	Signature File Update	32-9
	Application Flow Database	32-10

Configuring AppMon	32-11
Configuration Guidelines	32-12
Enabling/Disabling AppMon	32-14
Enabling/Disabling AppMon Per Port or Slot	32-14
Create Auto-Groups	32-15
Configuring Application Group	32-15
Configuring Application List	32-16
Activate Applications for AppMon	32-16
Configuring L3 Mode of Operation	32-17
Configuring L4 Mode of Operation	32-17
Clearing Flow Table Entries	32-18
Configuring Flow Table Statistics Update	32-18
Configuring Aging Interval	32-18
Configuring Logging Threshold	32-19
Configuring Sync Interval	32-19
Configuring Force Flow Sync	32-19
Clearing Application List	32-20
Configuring AppMon Enforcement QoS Policy Rules	32-20
Verifying AppMon Configuration	32-21
Chapter 33 Configuring Port Mapping	33-1
In This Chapter	33-1
Port Mapping Specifications	33-2
Port Mapping Defaults	33-2
Quick Steps for Configuring Port Mapping	33-3
Creating/Deleting a Port Mapping Session	33-4
Creating a Port Mapping Session	33-4
Deleting a User/Network Port of a Session	33-4
Deleting a Port Mapping Session	33-4
Enabling/Disabling a Port Mapping Session	33-5
Enabling a Port Mapping Session	33-5
Disabling a Port Mapping Session	33-5
Disabling the Flooding of Unknown Unicast Traffic	33-5
Configuring a Port Mapping Direction	33-5
Configuring Unidirectional Port Mapping	33-5
Restoring Bidirectional Port Mapping	33-5
Sample Port Mapping Configuration	33-6
Example Port Mapping Overview	33-6
Example Port Mapping Configuration Steps	33-7
Verifying the Port Mapping Configuration	33-7
Chapter 34 Configuring Learned Port Security	34-1
In This Chapter	34-1
Learned Port Security Specifications	34-2
Learned Port Security Defaults	34-2

Sample Learned Port Security Configuration 34-3

Learned Port Security Overview 34-5

 LPS Learning Window 34-5

 MAC Address Types 34-6

 How LPS Authorizes Source MAC Addresses 34-6

 MAC Address Behavior on LPS Ports 34-7

 Dynamic Configuration of Authorized MAC Addresses 34-9

 Static Configuration of Authorized MAC Addresses 34-9

 Understanding the LPS Table 34-9

Interaction With Other Features 34-10

 Access Guardian 34-10

 Universal Network Profile (UNP) 34-10

Configuring Learned Port Security 34-11

 Configuring the LPS Port Administrative Status 34-11

 Enabling LPS Functionality on a Port 34-12

 Disabling LPS Functionality on a Port 34-12

 Locking the LPS Port 34-12

 Removing the LPS Configuration from the Port 34-12

 Configuring the LPS Learning Window 34-13

 Configuring Learning Window Parameters 34-13

 Configuring the Number of Bridged MAC Addresses Allowed 34-16

 Configuring the Trap Threshold for Bridged MAC Addresses 34-16

 Configuring the Number of Filtered MAC Addresses Allowed 34-17

 Configuring an Authorized MAC Address Range 34-17

 Selecting the Security Violation Mode 34-18

Displaying Learned Port Security Information 34-20

Chapter 35

Diagnosing Switch Problems 35-1

In This Chapter 35-1

Port Mirroring Overview 35-3

 Port Mirroring Specifications 35-3

 Port Mirroring Defaults 35-3

 Quick Steps for Configuring Port Mirroring 35-4

Port Monitoring Overview 35-5

 Port Monitoring Specifications 35-5

 Port Monitoring Defaults 35-5

 Quick Steps for Configuring Port Monitoring 35-6

sFlow Overview 35-7

 sFlow Specifications 35-7

 sFlow Defaults 35-7

 Quick Steps for Configuring sFlow 35-8

Remote Monitoring (RMON) Overview 35-10

 RMON Specifications 35-10

 RMON Probe Defaults 35-10

 Quick Steps for Enabling/Disabling RMON Probes 35-11

Switch Health Overview	35-12
Switch Health Specifications	35-12
Switch Health Defaults	35-13
Quick Steps for Configuring Switch Health	35-13
Port Mirroring	35-14
What Ports Can Be Mirrored?	35-14
How Port Mirroring Works	35-14
What Happens to the Mirroring Port	35-15
Mirroring on Multiple Ports	35-15
Using Port Mirroring with External RMON Probes	35-15
Remote Port Mirroring	35-17
Creating a Mirroring Session	35-17
Unblocking Ports (Protection from Spanning Tree)	35-18
Enabling or Disabling Mirroring Status	35-18
Disabling a Mirroring Session (Disabling Mirroring Status)	35-19
Configuring Port Mirroring Direction	35-19
Enabling or Disabling a Port Mirroring Session (Shorthand)	35-20
Displaying Port Mirroring Status	35-20
Deleting A Mirroring Session	35-20
Configuring Remote Port Mirroring	35-21
Port Monitoring	35-22
Configuring a Port Monitoring Session	35-23
Enabling a Port Monitoring Session	35-23
Disabling a Port Monitoring Session	35-23
Deleting a Port Monitoring Session	35-23
Pausing a Port Monitoring Session	35-24
Configuring Port Monitoring Session Persistence	35-24
Configuring a Port Monitoring Data File	35-24
Configuring Port Monitoring Direction	35-25
Configuring Capture Type	35-25
Displaying Port Monitoring Status and Data	35-25
sFlow	35-26
sFlow Manager	35-26
Receiver	35-26
Sampler	35-27
Poller	35-27
Configuring an sFlow Session	35-27
Configuring a Fixed Primary Address	35-28
Displaying an sFlow Receiver	35-28
Displaying an sFlow Sampler	35-28
Displaying an sFlow Poller	35-29
Displaying an sFlow Agent	35-29
Deleting an sFlow Session	35-29
Remote Monitoring (RMON)	35-30
Ethernet Statistics	35-31
History (Control & Statistics)	35-31
Alarm	35-31
Event	35-31
Enabling or Disabling RMON Probes	35-32

Displaying RMON Tables	35-33
Displaying a List of RMON Probes	35-33
Displaying Statistics for a Particular RMON Probe	35-34
Sample Display for Ethernet Statistics Probe	35-34
Sample Display for History Probe	35-35
Sample Display for Alarm Probe	35-35
Displaying a List of RMON Events	35-36
Displaying a Specific RMON Event	35-36
Monitoring Switch Health	35-37
Configuring Resource Thresholds	35-38
Displaying Health Threshold Limits	35-39
Configuring Sampling Intervals	35-39
Viewing Sampling Intervals	35-39
Viewing Health Statistics for the Switch	35-40
Viewing Health Statistics for a Specific Interface	35-40
Chapter 36	
Configuring VLAN Stacking	36-1
In This Chapter	36-1
VLAN Stacking Specifications	36-2
VLAN Stacking Defaults	36-2
VLAN Stacking Overview	36-3
How VLAN Stacking Works	36-5
VLAN Stacking Services	36-6
Interaction With Other Features	36-7
Link Aggregation	36-7
Quality of Service (QoS)	36-7
Spanning Tree	36-7
Quick Steps for Configuring VLAN Stacking	36-8
Configuring VLAN Stacking Services	36-10
Configuring SVLANs	36-11
Configuring a VLAN Stacking Service	36-12
Configuring VLAN Stacking Network Ports	36-13
Configuring a NNI Association with a SVLAN	36-14
Configuring a VLAN Stacking Service Access Point	36-14
Configuring VLAN Stacking User Ports	36-16
Configuring the Type of Customer Traffic to Tunnel	36-16
Configuring a Service Access Point Profile	36-18
Associating a Profile with a Service Access Point	36-19
Configuring a UNI Profile	36-19
Associating UNI Profiles with UNI Ports	36-20
VLAN Stacking Application Example	36-21
VLAN Stacking Configuration Example	36-22
Verifying the VLAN Stacking Configuration	36-24

Chapter 37	Using Switch Logging	37-1
	In This Chapter	37-1
	Switch Logging Specifications	37-2
	Switch Logging Defaults	37-2
	Quick Steps for Configuring Switch Logging	37-3
	Switch Logging Overview	37-4
	Switch Logging Commands Overview	37-5
	Enabling Switch Logging	37-5
	Setting the Switch Logging Severity Level	37-5
	Specifying the Severity Level	37-7
	Removing the Severity Level	37-8
	Specifying the Switch Logging Output Device	37-8
	Enabling/Disabling Switch Logging Output to the Console	37-8
	Enabling/Disabling Switch Logging Output to Flash Memory	37-8
	Specifying an IP Address for Switch Logging Output	37-8
	Disabling an IP Address from Receiving Switch Logging Output	37-9
	Configuring the Switch Logging File Size	37-10
	Clearing the Switch Logging Files	37-10
	Displaying Switch Logging Records	37-11
Chapter 38	Configuring Ethernet OAM	38-1
	In This Chapter	38-1
	Ethernet OAM Specifications	38-2
	Ethernet OAM Defaults	38-2
	Ethernet OAM Overview	38-3
	Ethernet Service OAM	38-3
	Elements of Service OAM	38-3
	CFM Maintenance Domain	38-3
	Fault Management	38-5
	Performance Monitoring	38-5
	Interoperability with ITU-T Y.1731	38-7
	Quick Steps for Configuring Ethernet OAM	38-8
	Configuring Ethernet OAM	38-9
	Configuring a Maintenance Domain	38-9
	Modifying a Maintenance Domain	38-10
	Configuring a Maintenance Association	38-10
	Configuring Maintenance Association Attributes	38-10
	Configuring a Maintenance End Point	38-11
	Configuring a Virtual Maintenance End Point	38-11
	Configuring MEP Attributes	38-11
	Configuring Loopback	38-12
	Configuring Linktrace	38-12
	Configuring the Fault Alarm Time	38-12

	Configuring the Fault Reset Time	38-12
	Configuring Ethernet Frame Delay Measurement	38-13
	Verifying the Ethernet OAM Configuration	38-14
Appendix A	Software License and Copyright Statements	A-1
	Alcatel-Lucent License Agreement	A-1
	ALCATEL-LUCENT SOFTWARE LICENSE AGREEMENT	A-1
	Third Party Licenses and Notices	A-4
	Index	Index-1

About This Guide

This *OmniSwitch AOS Release 8 Network Configuration Guide* describes basic attributes of your switch and basic switch administration tasks. The software features described in this manual are shipped standard with your switches. These features are used when readying a switch for integration into a live network environment.

Supported Platforms

The information in this guide applies only to OmniSwitch 6860 and OmniSwitch 6860E switches.

Who Should Read this Manual?

The audience for this user guide are network administrators and IT support personnel who need to configure, maintain, and monitor switches and routers in a live network. However, anyone wishing to gain knowledge on how fundamental software features are implemented in the OmniSwitch Series switches will benefit from the material in this configuration guide.

When Should I Read this Manual?

Read this guide as soon as your switch is up and running and you are ready to familiarize yourself with basic software functions. You should have already stepped through the first login procedures and read the brief software overviews in the *Hardware Guide*.

You must have already set up a switch password and be familiar with the very basics of the switch software. This manual will help you understand the switch's directory structure, the Command Line Interface (CLI), configuration files, basic security features, and basic administrative functions. The features and procedures in this guide will help form a foundation that will allow you to configure more advanced switching features later.

What is in this Manual?

This configuration guide includes information about the following features:

- Basic switch administrative features, such as file editing utilities, procedures for loading new software, and setting up system information (name of switch, date, time).
- Configurations files, including snapshots, off-line configuration, time-activated file download.
- The CLI, including on-line configuration, command-building help, syntax error checking, and line editing.
- Basic security features, such as switch access control and customized user accounts.
- SNMP
- Web-based management (WebView)

What is Not in this Manual?

The configuration procedures in this manual primarily use Command Line Interface (CLI) commands in examples. CLI commands are text-based commands used to manage the switch through serial (console port) connections or through Telnet sessions. This guide does include introductory chapters for alternative methods of managing the switch, such as web-based (WebView) and SNMP management. However the primary focus of this guide is managing the switch through the CLI.

Further information on WebView can be found in the context-sensitive on-line help available with that application.

This guide does not include documentation for the OmniVista network management system. However, OmniVista includes a complete context-sensitive on-line help system.

This guide provides overview material on software features, how-to procedures, and tutorials that will enable you to begin configuring your OmniSwitch. However, it is not intended as a comprehensive reference to all CLI commands available in the OmniSwitch. For such a reference to all CLI commands, consult the *OmniSwitch AOS Release 8 CLI Reference Guide*.

How is the Information Organized?

Each chapter in this guide includes sections that will satisfy the information requirements of casual readers, rushed readers, serious detail-oriented readers, advanced users, and beginning users.

Quick Information. Most chapters include a *specifications table* that lists RFCs and IEEE specifications supported by the software feature. In addition, this table includes other pertinent information such as minimum and maximum values and sub-feature support. Some chapters include a *defaults table* that lists the default values for important parameters along with the CLI command used to configure the parameter. Many chapters include *Quick Steps* sections, which are procedures covering the basic steps required to get a software feature up and running.

In-Depth Information. All chapters include *overview sections* on software features as well as on selected topics of that software feature. *Topical sections* may often lead into *procedure sections* that describe how to configure the feature just described. Many chapters include *tutorials* or *application examples* that help convey how CLI commands can be used together to set up a particular feature.

Documentation Roadmap

The OmniSwitch user documentation suite was designed to supply you with information at several critical junctures of the configuration process. The following section outlines a roadmap of the manuals that will help you at each stage of the configuration process. Under each stage, we point you to the manual or manuals that will be most helpful to you.

Stage 1: Using the Switch for the First Time

Pertinent Documentation: *OmniSwitch 6860/6860E Hardware Users Guide*
Release Notes

This guide provides all the information you need to get your switch up and running the first time. It provides information on unpacking the switch, rack mounting the switch, installing NI modules, unlocking access control, setting the switch's IP address, and setting up a password. It also includes succinct overview information on fundamental aspects of the switch, such as hardware LEDs, the software directory structure, CLI conventions, and web-based management.

At this time you should also familiarize yourself with the Release Notes that accompanied your switch. This document includes important information on feature limitations that are not included in other user guides.

Stage 2: Gaining Familiarity with Basic Switch Functions

Pertinent Documentation: *OmniSwitch 6860/6860E Hardware Users Guide*
OmniSwitch AOS Release 8 Switch Management Guide

Once you have your switch up and running, you will want to begin investigating basic aspects of its hardware and software. Information about switch hardware is provided in the *OmniSwitch Hardware Guide*. This guide provides specifications, illustrations, and descriptions of all hardware components, such as chassis, power supplies, Chassis Management Modules (CMMs), Network Interface (NI) modules, and cooling fans. It also includes steps for common procedures, such as removing and installing switch components.

This guide is the primary users guide for the basic software features on a single switch. This guide contains information on the switch directory structure, basic file and directory utilities, switch access security, SNMP, and web-based management. It is recommended that you read this guide before connecting your switch to the network.

Stage 3: Integrating the Switch Into a Network

Pertinent Documentation: *OmniSwitch AOS Release 8 Network Configuration Guide*
OmniSwitch AOS Release 8 Advanced Routing Configuration Guide

When you are ready to connect your switch to the network, you will need to learn how the OmniSwitch implements fundamental software features, such as 802.1Q, VLANs, Spanning Tree, and network routing protocols. The *OmniSwitch AOS Release 8 Network Configuration Guide* contains overview information, procedures, and examples on how standard networking technologies are configured on the OmniSwitch.

The *OmniSwitch AOS Release 8 Advanced Routing Configuration Guide* includes configuration information for networks using advanced routing technologies (OSPF and BGP) and multicast routing protocols (DVMRP and PIM-SM).

Anytime

The *OmniSwitch AOS Release 8 CLI Reference Guide* contains comprehensive information on all CLI commands supported by the switch. This guide includes syntax, default, usage, example, related CLI command, and CLI-to-MIB variable mapping information for all CLI commands supported by the switch. This guide can be consulted anytime during the configuration process to find detailed and specific information on each CLI command.

Related Documentation

The following are the titles and descriptions of all the related OmniSwitch user manuals:

- *OmniSwitch 6860/6860E Hardware Users Guides*

Complete technical specifications and procedures for all OmniSwitch chassis, power supplies, fans, and Network Interface (NI) modules.

- *OmniSwitch AOS Release 8 Switch Management Guide*

Includes procedures for readying an individual switch for integration into a network. Topics include the software directory architecture, image rollback protections, authenticated switch access, managing switch files, system configuration, using SNMP, and using web management software (WebView).

- *OmniSwitch AOS Release 8 Network Configuration Guide*

Includes network configuration procedures and descriptive information on all the major software features and protocols included in the base software package. Chapters cover Layer 2 information (Ethernet and VLAN configuration), Layer 3 information (routing protocols, such as RIP and IPX), security options (authenticated VLANs), Quality of Service (QoS), link aggregation, and server load balancing.

- *OmniSwitch AOS Release 8 Advanced Routing Configuration Guide*

Includes network configuration procedures and descriptive information on all the software features and protocols included in the advanced routing software package. Chapters cover multicast routing (DVMRP and PIM-SM), Open Shortest Path First (OSPF), and Border Gateway Protocol (BGP).

- *OmniSwitch AOS Release 8 CLI Reference Guide*

Complete reference to all CLI commands supported on the OmniSwitch. Includes syntax definitions, default values, examples, usage guidelines and CLI-to-MIB variable mappings.

- *OmniSwitch AOS Release 8 Transceivers Guide*

Includes SFP and XFP transceiver specifications and product compatibility information.

- *Technical Tips, Field Notices*

Includes information published by Alcatel-Lucent's Customer Support group.

- *Release Notes*

Includes critical Open Problem Reports, feature exceptions, and other important information on the features supported in the current release and any limitations to their support.

Technical Support

An Alcatel-Lucent service agreement brings your company the assurance of 7x24 no-excuses technical support. You will also receive regular software updates to maintain and maximize your Alcatel-Lucent product features and functionality and on-site hardware replacement through our global network of highly qualified service delivery partners.

With 24-hour access to Alcatel-Lucent Service and Support web page, you will be able to view and update any case (open or closed) that you have reported to Alcatel-Lucent technical support, open a new case or access helpful release notes, technical bulletins, and manuals.

Access additional information on Alcatel-Lucent Service Programs:

Web: service.esd.alcatel-lucent.com

Phone: 1-800-995-2696

Email: esd.support@alcatel-lucent.com

1 Configuring Ethernet Ports

The Ethernet software is responsible for a variety of functions that support Ethernet, Gigabit Ethernet, and 10 Gigabit Ethernet ports on OmniSwitch Series switches. These functions include diagnostics, software loading, initialization, configuration of line parameters, gathering statistics, and responding to administrative requests from SNMP or CLI.

In This Chapter

This chapter describes the Ethernet port parameters of the switch and how to configure them through the Command Line Interface (CLI). CLI Commands are used in the configuration examples.

Configuration procedures described in this chapter include:

- [“Ethernet Ports Overview” on page 1-4](#)
- [“Configuring Ethernet Port Parameters” on page 1-4](#)
- [“Using TDR Cable Diagnostics” on page 1-10](#)
- [“Clearing Ethernet Port Violations” on page 1-12](#) [“Link Monitoring” on page 1-13](#)
- [“Link Fault Propagation” on page 1-20](#)

For information about CLI commands that can be used to view Ethernet port parameters, see the *OmniSwitch AOS Release 8 CLI Reference Guide*.

Ethernet Specifications

IEEE Standards Supported	802.3 Carrier Sense Multiple Access with Collision Detection (CSMA/CD) 802.3u (100BaseTX) 802.3ab (1000BaseT) 802.3z (1000Base-X) 802.3ae (10GBase-X) 802.3az (Energy Efficient Ethernet)
Platforms Supported	OmniSwitch 6860, 6860E
Ports Supported	Ethernet (10 Mbps) Fast Ethernet (100 Mbps) Gigabit Ethernet (1 Gbps) 10 Gigabit Ethernet (10 Gbps)
Auto Negotiation	Supported
Port Mirroring / Monitoring	Supported
802.1Q Hardware Tagging	Supported
Jumbo Frame Configuration	Supported on 1/10 Gigabit Ethernet ports
Enhanced Port Performance (EPP)	Supported on 10-Gigabit transceivers
Maximum Frame Size	1553 bytes (10/100 Mbps) 9216 bytes (1/10 Gbps)

Ethernet Port Defaults

The following table shows Ethernet port default values:

Parameter Description	Command	Default Value/Comments
Interface Line Speed	interfaces speed	AutoNeg
Interface Duplex Mode	interfaces duplex	AutoNeg
Trap Port Link Messages	interfaces link-trap	Disabled
Interface Configuration	interfaces	Enabled
Peak Flood Rate Configuration	interfaces flood-limit	4 Mbps (10 Ethernet) 49 Mbps (100 Fast Ethernet) 496 Mbps (1 Gigabit Ethernet) 997 Mbps (10 Gigabit Ethernet)
Interface Alias	interfaces alias	None configured
Maximum Frame Size	interfaces max-frame-size	1553 (untagged) Ethernet packets 1553 (tagged) Ethernet packets 9216 Gigabit Ethernet packets
Digital Diagnostics Monitoring (DDM)	interfaces ddm	Disabled

Parameter Description	Command	Default Value/Comments
Enhanced Port Performance (EPP)	interfaces	Disabled

Ethernet Ports Overview

This chapter describes the Ethernet software CLI commands used for configuring and monitoring the Ethernet port parameters of your switch.

Valid Port Settings

This table below lists valid speed, duplex, and autonegotiation settings for the different OmniSwitch 6860, 6860E port types.

Port Type	User-Specified Port Speed (Mbps) Supported	User-Specified Duplex Supported	Auto Negotiation Supported?
10/100/1000 Copper	auto/10/100/1000	auto/full/half	Yes
Transceivers	Dependent	Dependent	Dependent

See the *Hardware Users Guide* for more information about the hardware and port numbering for specific models.

Configuring Ethernet Port Parameters

The following sections describe how to use CLI commands to configure ethernet ports.

Enabling and Disabling Autonegotiation

To enable or disable autonegotiation on a single port, a range of ports, or an entire slot, use the [interfaces](#) command. For example:

```
-> interfaces 2/1/3 autoneg enable
-> interfaces 2/1/1-3 autoneg enable
-> interfaces slot 2/1 autoneg enable
```

Setting Interface Line Speed

The [interfaces speed](#) command is used to set the line speed on a specific port, a range of ports, or all ports on an entire slot.

For example:

```
-> interfaces 2/1/1 speed 100
-> interfaces 2/1/2-5 speed 1000
-> interfaces slot 3/1 speed auto
```

Configuring Duplex Mode

The [interfaces duplex](#) command is used to configure the duplex mode on a specific port, a range of ports, or all ports on a slot to **full**, **half**, or **auto**. (The **auto** option causes the switch to advertise all available duplex modes (half/full/both) for the port during autonegotiation.) In full duplex mode, the interface

transmits and receives data simultaneously. In half duplex mode, the interface can only transmit or receive data at a given time.

For example:

```
-> interfaces 2/1/1 duplex half
-> interfaces 2/1/2-5 duplex auto
-> interfaces slot 3/1 duplex full
```

Setting Trap Port Link Messages

The **interfaces link-trap** command can be used to enable or disable trap port link messages on a specific port, a range of ports, or all ports on a slot. When enabled, a trap message is sent to a Network Management Station (NMS) whenever the port state has changed.

For example:

```
-> interfaces 2/1/3 link-trap enable
-> interfaces 2/1/3-5 link-trap enable
-> interfaces slot 2/1 link-trap enable
```

Resetting Statistics Counters

The **clear interfaces** command is used to reset all Layer 2 statistics counters on a specific port, a range of ports, or all ports on a slot. For example:

```
-> clear interfaces 2/1/3 l2-statistics
-> clear interfaces 2/1/1-3 l2-statistics
-> clear interfaces slot 2/1 l2-statistics
```

This command also includes an optional **cli** parameter. When this parameter is specified, only those statistics that are maintained by the switch CLI are cleared; SNMP values are not cleared and continue to maintain cumulative totals. For example:

```
-> clear interfaces 2/1/1-3 l2-statistics cli
```

Note that when the **cli** parameter is not specified both CLI and SNMP statistics are cleared.

Enabling and Disabling Interfaces

The **interfaces** command is used to enable or disable a specific port, a range of ports, or all ports on an entire slot.

```
-> interfaces 2/1/3 admin-state disable
-> interfaces 2/1/1-3 admin-state disable
-> interfaces slot 2/1 admin-state disable
```

Configuring a Port Alias

The **interfaces alias** command is used to configure an alias (description) for a single port. (You cannot configure an entire switch or a range of ports.) For example:

```
-> interfaces 2/1/3 alias ip_phonel
-> interfaces 2/1/3 alias "ip phones 1
```

Note. Spaces must be contained within quotes.

Configuring Maximum Frame Sizes

The **interfaces max-frame-size** command can be used to configure the maximum frame size (in bytes) on a specific port, a range of ports, or all ports on a switch.

For example:

```
-> interfaces 2/1/3 max frame 9216
-> interfaces 2/1/1-3 max frame 9216
-> interfaces slot 2/1 max frame 9216
```

Configuring Digital Diagnostic Monitoring (DDM)

Digital Diagnostics Monitoring allows the switch to monitor the status of a transceiver by reading the information contained on the transceiver's EEPROM. The transceiver can display Actual, Warning-Low, Warning-High, Alarm-Low and Alarm-High for the following:

- Temperature
- Supply Voltage
- Current
- Output Power
- Input Power

To enable the DDM capability on the switch use the **interfaces ddm** command. For example, enter:

```
-> interfaces ddm enable
```

Traps can be enabled using the **interfaces ddm-trap** if any of the above values crosses the pre-defined low or high thresholds of the transceiver. For example:

```
-> interfaces ddm-trap enable
```

Note. In order to take advantage of the DDM capability, the transceiver must support the DDM functionality. Not all transceivers support DDM; refer to the Transceivers Guide for additional DDM information.

Configuring Flood Rate Limiting

The following section describes how to apply a flood limit value to broadcast, unicast flooded, or multicast traffic for a slot, port, or a range of ports. The **interfaces flood-limit** command can be used to set limits based on pps, mbps, or a percentage of the port bandwidth.

For example:

```
-> interfaces 2/1/1 flood-limit bcast rate mbps 100
-> interfaces 2/1/2-5 flood-limit ucast rate pps 500
-> interfaces slot 3/1 flood-limit mcast rate cap% 50
```

The auto recovery has to be enabled by configuring the low threshold. The high and low threshold when configured, will have same type [mbps, pps, and percentage].

For example:

```
-> interfaces 1/1/1 flood-limit bcast rate mbps 60 low-threshold 40
-> interfaces 1/1/4 flood-limit ucast rate mbps 100 low-threshold 40
-> interfaces 1/1/5 flood-limit mcast rate pps 2000 low-threshold 1000
```

Configuring Flood Rate Limit Action

The following section describes how to apply action, when a port reaches storm violated state. You can set an “action” for a single port or a range of ports.

For example:

```
-> interfaces 1/1/1 flood-limit bcast action shutdown
-> interfaces 1/1/4 flood ucast action trap
-> interfaces 1/1/11 flood-limit all action shutdown
-> interfaces 1/1/14 flood mcast action default
```

When the action is set as “shutdown”, it specifies that when high threshold is violated, the port needs to be put in blocked state. When the action is set as “trap”, it specifies that when high threshold is crossed, the trap will be sent with the violation reason. Similarly, when the action is set as “default”, it specifies that when traffic reaches high threshold, packets above that rate will be dropped.

Configuring Flow Control

The **interfaces pause** command is used to configure flow control (pause) settings for ports that run in full duplex mode. Configuring flow control is done to specify whether or not an interface transmits, honors, or both transmits and honors PAUSE frames. PAUSE frames are used to temporarily pause the flow of traffic between two connected devices to help prevent packet loss when traffic congestion occurs between switches.

Note. The OmniSwitch currently does not support the transmitting of PAUSE frames.

Note that if autonegotiation and flow control are both enabled for an interface, then autonegotiation determines how the interface processes PAUSE frames. If autonegotiation is disabled but flow control is enabled, then the configured flow control settings apply.

By default, flow control is disabled. To configure flow control for one or more ports, use the **interfaces pause** command with one of the following parameters to specify how PAUSE frames are processed:

- **tx**—Transmit PAUSE frames to peer switches when traffic congestion occurs on the local interface. Do not honor PAUSE frames from peer switches.
- **rx**—Allow the interface to honor PAUSE frames from peer switches and temporarily stop sending traffic to the peer. Do not transmit PAUSE frames to peer switches.
- **tx-and-rx**—Transmit and honor PAUSE frames when traffic congestion occurs between peer switches.

For example, the following command configures ports 1/1 through 1/10 to transmit and honor PAUSE frames:

```
-> interfaces 1/1/1-10 pause tx-and-rx
```

To disable flow control for one or more ports, specify the **disable** parameter with the **interfaces pause** command. For example:

```
-> interfaces 1/1/10 pause disable
```

Enabling and Disabling Enhanced Port Performance (EPP)

EPP can assist in connecting with SFF-8431 non-compliant or electrically deficient devices. EPP can be used on some links to enhance the receive signal sampling resolution management and help to improve the link integrity to the link partner. The following steps must be followed to determine if EPP must be enabled:

- 1 Check the current link quality** - Check the current link quality of the interface.
- 2 Diagnose any link quality issues** - If the Link Quality is not 'Good'. Perform a few basic troubleshooting steps to determine if the issue is with the link partner and whether enabling EPP can help improve the quality.
- 3 Enable EPP** - If it's determined that the issue is with the link partner, enable EPP.

EPP - Check the Current Link Quality

A Link-Quality parameter has been added to help support EPP functionality. If connectivity issues are being observed check the current link quality using the **interfaces** command and observe the EPP output. For example:

```
-> show interfaces 1/1/25
(output truncated)

EPP : Disabled,   Link-Quality:Fair
```

Link-Quality	Description
Good	Link is good
Fair	Link may exhibit errors
Poor	Link will exhibit errors and may lose connectivity
N/A	Link does not support EPP

EPP - Diagnose

For ports diagnosed as **Fair** or **Poor**, simple steps can be performed to identify the faulty component. Since the issue could be with the transceiver, cable, fiber, or the link partner, see the table below to help determine if the issue is with the link partner and if enabling EPP may help.

Media Type	Diagnostic Action
------------	-------------------

Direct Attached Copper Cable	<ul style="list-style-type: none"> • Disconnect cable from link partner • Connect free cable end to unused port • View the Link-Quality <p>Good - The link partner must be diagnosed and enabling EPP may help. Fair or Poor - The direct-attached copper cable must be replaced.</p>
SFP+ optical transceiver	<ul style="list-style-type: none"> • Replace SFP+ transceiver • View the Link-Quality <p>Good - The original SFP+ transceiver is faulty. Fair or Poor - The fiber cable or link partner must be diagnosed and enabling EPP may help.</p>

EPP - Enabling

If after diagnosing the problem it is determined that the issue is with the link partner and the Link-Quality has been diagnosed to be **Fair** or **Poor**, EPP can be enabled allowing the system to operate with the deficient receive channels. For example:

```
-> interfaces 1/1/1 epp enable
```

After enabling EPP continue to monitor the Link-Quality.

Configuring Energy Efficient Ethernet (802.3az)

Energy Efficient Ethernet (EEE) is a protocol to allow ports to operate in idle or low power mode when there is no traffic to send. When EEE is enabled on a port it will advertise its EEE capability to its link partner. If the partner supports EEE they will operate in EEE mode. If the partner does not support EEE the ports will operate in legacy mode. This allows EEE capable switches to be deployed in existing networks avoiding backward compatibility issues.

- EEE is only applicable to copper ports.
- The LLDP option in IEEE 802.3az standard is not currently supported.

To enable the EEE capability on the switch use the **interfaces eee** command. For example:

```
-> interfaces 1/1/1 eee enable
```

Using TDR Cable Diagnostics

Time Domain Reflectometry (TDR) is a feature that is used to detect cable faults. This feature is best deployed in networks where service providers and system administrators want to quickly diagnose the state of a cable during outages, before proceeding with further diagnosis.

When a TDR test is initiated, a signal is sent down a cable to determine the distance to a break or other discontinuity in the cable path. The length of time it takes for the signal to reach the break and return is used to estimate the distance to the discontinuity.

Initiating a TDR Cable Diagnostics Test

Consider the following guidelines before initiating a TDR test:

- Only one test can run at any given time, and there is no way to stop a test once it has started.
- The TDR test runs an “out-of-service” test; other data and protocol traffic on the port is interrupted when the test is active.
- TDR is supported only on copper ports.
- TDR is not supported on Link aggregate ports.
- Each time a TDR test is run, statistics from a test previously run on the same port are cleared.

A TDR test is initiated using the `interfaces tdr` CLI command. For example, the following command starts the test on port 2/1:

```
-> interfaces 1/1/1 tdr enable
```

Displaying TDR Test Results

The `show interfaces tdr-statistics` command is used to display TDR test statistics. For example:

```
-> show interfaces 1/1/1 tdr-statistics
Legend:
Pair 1 - green and white
Pair 2 - orange and white
Pair 3 - brown and white
Pair 4 - blue and white

Ch/Slot/ No of Cable Fuzzy Pair1 Pair1 Pair2 Pair2 Pair3 Pair3 Pair4 Pair4 Test
port pairs State Length State Length State Length State Length State Length Result
-----+-----+-----+-----+-----+-----+-----+-----+-----+-----+-----+-----
1/1/1 4 ok 0 ok 3 ok 3 ok 3 ok 3 success
```

The following cable states are indicated in the `show interfaces tdr-statistics` command output:

- **OK**—Wire is working properly
- **Open**:—Wire is broken
- **Short**—Pairs of wire are in contact with each other
- **Crosstalk**—Signal transmitted on one pair of wire creates an undesired effect in another wire.
- **Unknown**:—Cable diagnostic test unable to find the state of a cable.

Clearing TDR Test Statistics

The **clear interfaces** command is used to clear the statistics of the last test performed on the port. There is no global statistics clear command. For example, the following command clears the TDR statistics:

```
-> clear interfaces 1/1/1 tdr-statistics
```

TDR statistics from a previous test are also cleared when a new test starts on the same port.

Clearing Ethernet Port Violations

The following switch applications may trigger a violation condition on one or more ports:

- Learned Port Security (LPS)
- Quality of Service (QoS)
- Network Security
- UniDirectional Link Detection (UDLD)
- Fabric stability related violations

Depending on the application and type of violation, specific actions are taken when a violation is detected on the port. For example, an application may take one of the following actions when the violation triggers a port shut down:

- **Admin Down**—deactivates the physical port.
- **Simulated Down**—the physical port shows as active but the applications are not allowed to access the port link. The port is put in a blocking state.

A security violation may occur under the following conditions:

- A port is configured as a secure port and the number of secure MAC addresses learned on the port has exceeded the maximum value.
- A device with a secure MAC address that is configured or learned on one of the secure ports attempts to access another secure port.

Consider the following regarding link aggregate security violations:

- When a violation occurs on a physical port that is a member of a link aggregate, the violation affects the entire link aggregate group. All ports on that link aggregate are either restricted or shut down.
- When the violations are cleared for the entire link aggregate group, the whole link aggregate group is reactivated.
- When a simulated down violation occurs, toggling the link clears the violation for both the link aggregates and physical ports.

To view the violation conditions that exist on individual ports or link aggregates, use the [show violation](#) command. For example:

```
-> show violation
```

Port	Source	Action	Reason	Timer
1/1/1	src lrn	simulated down	lps shutdown	0
2/1/2	src lrn	simulated down	lps restrict	0

To clear all the MAC address violation logs and activate the port or link aggregate, use the [clear violation](#) command. For example:

```
-> clear violation port 1/1/10
-> clear violation linkagg 10-20
```

Link Monitoring

The Link Monitoring feature is used to monitor interface status to minimize the network protocol re-convergence that can occur when an interface becomes unstable. To track the stability of an interface, this feature monitors link errors and link flaps during a configured timeframe. If the number of errors or link flaps exceeds configured thresholds during this time frame, the interface is shut down.

Note. Link Monitoring can be enabled on individual ports that make up a virtual port such as a link aggregate or VFL, but not on the entire link aggregate or VFL virtual port.

There are no explicit Link Monitoring commands to recover a port from a Link Monitoring shutdown. See [“Clearing Ethernet Port Violations” on page 1-12](#) for information of learning port violations.

Monitoring Interface Errors

When physical errors occur on an interface, control and data traffic is dropped causing unnecessary re-convergence for the network protocol running on the interface. The Link Monitoring feature monitors the physical errors such as CRC, lost frames, error frames and alignment errors. When a configurable number of errors is detected within the duration of a link monitoring window, the interface is shut down.

To configure the number of errors allowed before the port is shut down, use the [interfaces link-monitoring link-error-threshold](#) command. For example:

```
-> interfaces 1/1/1 link-monitoring link-error-threshold 50
```

In this example, the port is shutdown if the number of link errors exceeds the threshold value of 50 during the link monitoring window time frame.

Monitoring Interface Flapping

When physical connectivity errors occur on an interface, the interface becomes unstable and causes unnecessary re-convergence for the network protocols running on the interface. The Link Monitoring feature monitors these interface flaps and shuts down the interface when excessive flapping is detected.

- The shutdown action is a physical port shutdown (the PHY and LED are down).
- Whenever an interface comes up and it is not an administrative action (admin-up), the link flap counter is incremented.

The [interfaces link-monitoring link-flap-threshold](#) command is used to configure the number of flaps allowed before the interface is shutdown. For example:

```
-> interfaces 1/1/1 link-monitoring link-flap-threshold 5
```

In this example, the port is shutdown if the number of link flaps exceeds the threshold value of five during the link monitoring window timeframe.

Monitoring Window

The Link Monitoring window is a per-port configurable timer that is started whenever link-monitoring is enabled on a port. During this time frame interface receive errors and interface flaps are counted. If either of the values exceeds the configured thresholds the interface is shut down.

- The timer value can be modified even when the Link Monitoring timer is running and the new value of timer takes effect after the current running timer expires.
- The threshold values for link errors and link flaps can also be modified when link-monitoring timer is running; if the new threshold value is less than the current link-flap or link-error counter value, then the interface is shutdown immediately.

The **interfaces link-monitoring time-window** command is used to configure the monitoring window timer. For example:

```
-> interfaces 1/1/1 link-monitoring time-window 500
```

In this example, link monitoring will monitor port 1/1/1 for 500 seconds.

Starting a Link Monitoring Session

The Link Monitoring window timer is started when the feature is enabled on an interface using the **show violation-recovery-configuration** command. For example:

```
-> interfaces 1/1/1 link-monitoring admin-status enable
```

All the statistics (link errors and link flaps) for a port are reset to zero when Link Monitoring is enabled on that port.

Stopping a Link Monitoring Session

The Link Monitoring window timer is stopped when one of the following occurs:

- The **show violation-recovery-configuration** command is used to disable the feature on the port. For example:

```
-> interfaces 1/1/1 link-monitoring admin-status enable
```
- The port is shutdown by any feature, such as Link Monitoring, UDLD, or Link Fault Propagation.

Interfaces Violation Recovery

The OmniSwitch allows features to shutdown an interface when a violation occurs on that interface. To support this functionality, the following interfaces violation recovery mechanisms are provided:

- Manual recovery of a downed interface using the **clear violation** command.
- An automatic recovery timer that indicates how much time a port remains shut down before the switch automatically brings the port back up (see “[Configuring the Violation Recovery Time](#)” on page 1-17).
- A maximum number of recovery attempts setting that specifies how many recoveries can occur before a port is permanently shutdown (see “[Configuring the Violation Recovery Time](#)” on page 1-17).
- A wait-to-restore timer that indicates the amount of time the switch waits to notify features that the port is back up (see “[Configuring the Wait-to-Restore Timer](#)” on page 1-18).
- An SNMP trap that is generated each time an interface is shutdown by a feature. This can occur even when the interface is already shutdown by another feature. The trap also indicates the reason for the violation.
- An SNMP trap that is generated when a port is recovered. The trap also includes information about how the port was recovered. Enabling or disabling this type of trap is allowed using the **violation recovery-trap** command.

Violation Shutdown and Recovery Methods

A port can be shutdown with one of the following methods, depending on the feature.

Filtering – The port is blocked by applying filtering to discard all packets sent or received on the port. With this method the link LED of the port remains ON. A port in this state can be recovered using the following methods:

- Using the **clear violation** command to manually clear the violation.
- Automatic recovery when the interface recovery timer expires.
- Using the **interfaces alias** command to administratively disable and enable the interface.
- Disconnecting and reconnecting the interface link.
- A link down and link up event.

Administratively – A port is administratively disabled. With this method the LED does not remain ON. A port in this state can be recovered using only the following methods:

- Using the **clear violation** command to manually clear the violation.
- Automatic recovery when the interface recovery timer expires.
- Using the **interfaces alias** command to administratively disable and enable the interface.

Disconnecting/reconnecting the interface link or a link down/up event *will not* recover a port that was administratively disabled.

Interface Violation Exceptions

An interface violation is not applied to an interface when any of the following scenarios occur:

- An interface is already in a permanent shutdown state. In this case, the only method for recovery is to use the **clear violation** command.
- An interface is already shutdown by another feature.
- An interface is not operationally up.

Interaction With Other Features

The table below lists the features that use the interfaces violation recovery mechanisms, along with the violation reason and shutdown type.

Feature	Reason Code	Shutdown Type
BPDU Shutdown	STP	Discard
User Port Shutdown	QOS	Discard
Policy rule - port disable	QOS	Discard
LPS	LPS-D	Discard
LPS	LPS-S	Admin-Down
UDLD	UDLD	Admin-Down
NetSec	NetSec	Admin-Down
NI	NISup	Admin-Down
LLDP Rouge Detection	LLDP	Discard
Link Monitoring	LinkMon	Admin-Down
Link Fault Propagation	LFP	Admin-Down
Remote Fault Propagation	RFP	Admin-Down

Configuring Interface Violation Recovery

The following sections provide information about how to configure parameter values that apply to the interfaces violation recovery mechanisms.

Configuring the Violation Recovery Time

The violation recovery time specifies the amount of time the switch waits before automatically recovering a port that was shut down due to a violation. When the recovery timer expires, the interface is operationally re-enabled and the violation on the interface is cleared.

Consider the following when configuring the violation recover time:

- The timer value does not apply to interfaces that are in a permanent shutdown state. A port in this state is only recoverable using the **clear violation** command.
- The interface violation recovery mechanism is not supported on link aggregates, but is supported on the link aggregate member ports.

The **violation recovery-time** command is used to configure the automatic recovery time value, which is configurable on a per-port or global basis. For example, the following commands set the violation recovery time to 600 seconds at the global level and to 200 seconds for port 2/1 on chassis 1:

```
-> violation recovery-time 600
-> violation 1/2/1 recovery-time 200
```

The violation recovery time value configured for a specific interface overrides the global value configured for all switch interfaces. To set the port-level value back to the global value, use the **default** parameter with the **violation recovery-time** command. For example, the following command sets the violation recovery time for port 2/1 on chassis 1 back to the global value of 600:

```
-> violation 1/2/1 recovery-time default
```

To disable the violation recovery timer mechanism, set the recovery time to zero. For example:

```
-> violation recovery-time 0
-> violation 1/2/1 recovery-time 0
```

Configuring the Violation Recovery Maximum Attempts

The violation recovery maximum setting specifies the maximum number of recovery attempts allowed before a port is permanently shut down. This value increments by one whenever an interface recovers from a violation using the automatic recovery timer mechanism. When the number of recovery attempts exceeds this configured threshold, the interface is permanently shut down. The only way to recover a permanently shut down interface is to use the **clear violation** command.

The recovery mechanism tracks the number of recoveries within a fixed time window (FTW). The FTW = 2 * maximum recovery number * recovery timer. For example, if the maximum number of recovery attempts is set to 4 and the recovery timer is set to 5, the FTW is 40 seconds (2 * 4 * 5=40).

The **violation recovery-maximum** command is used to configure the maximum number of recovery attempts. This value is configurable on a per-port or global basis. For example, the following commands set the number of attempts to 3 at the global level and to 5 for port 2/1 on chassis 1:

```
-> violation recovery-maximum 3
-> violation 1/2/1 recovery-maximum 5
```

The maximum recovery attempts value configured for a specific interface overrides the global value configured for all switch interfaces. To set the port-level value back to the global value, use the **default** parameter with the **violation recovery-maximum** command. For example, the following command sets the number of recovery attempts for port 2/1 on chassis 1 back to the global value of 3:

```
-> violation 1/2/1 recovery-maximum default
```

To disable the violation recovery maximum attempts mechanism, set the number of attempts to zero. For example:

```
-> violation recovery-maximum 0
-> violation 1/2/1 recovery-maximum 0
```

Verifying the Interfaces Violation Recovery Configuration

Use the following **show** commands to verify the violation recovery configuration:

show interfaces	Displays the administrative status, link status, violations, recovery time, maximum recovery attempts and the value of the wait-to-restore timer.
show violation	Displays the address violations that occur on ports with LPS restrictions. This command displays a port violation for sticky port security when the maximum number of MAC address of the connected workstation that the switch learns.
show violation-recovery-configuration	Displays the globally configured recovery time, SNMP recovery trap enable/disable status and maximum recovery attempts.

For more information about the resulting displays from these commands, see the *OmniSwitch AOS Release 8 CLI Reference Guide*.

Configuring the Wait-to-Restore Timer

The wait-to-restore (WTR) timer is used to implement a delay before an interface is made operational for other features. Only after the timer has expired will the interface become active allowing network protocols to converge more gracefully. The timer value is configured on a per-port basis and is started whenever one of the following link-up events occurs:

- An interface is administratively downed followed by administratively up.
- The **clear violation** command is used.
- An interface recovers from a violation due to the automatic recovery timer mechanism.
- An interface is made operationally up when the cable is plugged in.

Consider the following when configuring the wait-to-restore timer:

- If the interface goes down again while the WTR timer is still running, the WTR timer is stopped. Otherwise, the interface is recovered after the time expires.
- The WTR timer functionality has no impact on link-error or link-flap detection; these features are configurable even when the WTR timer is disabled.
- The timer value can be modified when the WTR timer is running; however, the new timer value does not take effect until after the current running timer expires.

- The WTR timer is reset on every link up event that is detected.
- The WTR timer is stopped on detection of every link down event.
- When the WTR timer is running, the interface is physically up but the link status is down.

The **interfaces wait-to-restore** command is used to configure the WTR timer value, in multiples of 5. For example, the following commands set the WTR timer value to 300 seconds:

```
-> interfaces 1/1/1 wait-to-restore 300
```

To disable the WTR timer mechanism, set the timer value to zero. For example:

```
-> interfaces 1/1/1 wait-to-restore 0
```

By default, the WTR time is disabled.

Configuring the Wait-to-Shutdown Timer

The wait-to-shutdown (WTS) timer is used to implement a delay before an interface is made non-operational for other applications such as data, control and management. Only after the timer has expired will the interface become disabled allowing network protocols to converge more gracefully. The timer value is configured on a per-port basis and is started whenever one of the following link-up events occurs:

- An interface is administratively brought down.
- An interface is shutdown from a violation.
- An interface is made operationally down when the cable is unplugged in.

When the interface goes down, the WTS timer will be started. If the interface comes back up while the WTS timer is running, then WTS timer will be stopped and no link down event will be sent. Otherwise, after the WTS timer expires a link-down event will be sent to all the relevant applications.

Consider the following when configuring the wait-to-shutdown timer:

- If the interface comes back up while the WTS timer is still running, the WTS timer is stopped and no link down event is sent to other switch applications.
- The WTR timer functionality has no impact on link-error or link-flap detection; these features are configurable even when the WTS timer is disabled.
- The timer value can be modified when the WTS timer is running; however, the new timer value does not take effect until after the current running timer expires.
- When the wait-to-shutdown timer is running there would be packet loss on that interface. This is because the port is physical down and only the link-down event is not being communicated to the switch applications which will continue to send packets to the interface.
- The link-status of the remote connected port will be down when the WTS timer is running since the port is physically down.

The **interfaces wait-to-shutdown** command is used to configure the WTS timer value, in multiples of 10 milliseconds. For example, the following commands set the WTR timer value to 30 seconds:

```
-> interfaces 1/1/1 wait-to-shutdown 30000
```

To disable the WTR timer mechanism, set the timer value to zero. For example:

```
-> interfaces 1/1/1 wait-to-shutdown 0
```

By default, the WTS time is disabled.

Displaying Link Monitoring Information

Use the following **show** commands to display Link Monitoring statistics and configuration information:

show interfaces link-monitoring statistics	Displays Link Monitoring statistics, such as the link flap and error counts and the port state (shutdown, down, up).
show interfaces link-monitoring config	Displays the Link Monitoring configuration, such as the monitoring status, monitoring window time, and the link flap and error thresholds.
violation recovery-maximum	Displays the administrative status, link status, violations, recovery time, maximum recovery attempts and the value of the wait-to-restore timer.

For more information about the resulting displays from these commands, see the *OmniSwitch AOS Release 8 CLI Reference Guide*.

Link Fault Propagation

The Link Fault Propagation (LFP) feature provides a mechanism to propagate a local interface failure into another local interface. In many scenarios, a set of ports provide connectivity to the network. If all these ports go down, the connectivity to the network is lost. However, the remote end remains unaware of this loss of connectivity and continues to send traffic that is unable to reach the network. To solve this problem, LFP does the following:

- Monitors a group of interfaces (configured as source ports).
- If all the source ports in the group go down, LFP waits a configured amount of time then shuts down another set of interfaces (configured as destination ports) that are associated with the same group.
- When any one of the source ports comes back up, all of the destination ports are brought back up and network connectivity is restored.

The LFP source and destination ports can be physical or link aggregation ports. If the destination port is a link aggregation port the shutdown consists of shutting down all members of the link aggregation group (physically down). However, the link aggregation group remains administratively enabled.

Interaction With Interfaces Violation Recovery

- The **clear violation** command will clear the LFP violations and mark the interfaces as up even if the violation condition still exists.
- An admin down followed by an admin up will clear the LFP violation and mark the interfaces as up even if the violation condition still exists.
- When the destination port is a link aggregate, the shutdown action does not shutdown the link aggregation. Instead, all the ports that are members of the link aggregation at the time of the violation are shutdown.
- A link aggregate port remains in a violation state even if the port leaves the link aggregate.
- If a port that is not a member of a link aggregate at the time a violation occurred is added to a link aggregate, the switch will not shut down the port.
- SNMP traps cannot be configured for LFP. The interface violation recovery mechanism will be responsible for sending traps when a port is shutdown or recovered by LFP.
- If the wait-to-restore (WTR) timer is configured on the source ports of a LFP group with link monitoring enabled, the state of the destination ports of the group will be determined by the link state of the ports after the WTR timer has expired.

See “[Interfaces Violation Recovery](#)” on [page 1-15](#) for information of learning port violations.

Configuring Link Fault Propagation

Configuring LFP requires the following steps:

1 Create an LFP group. This type of group identifies the source ports to monitor and the destination ports to bring down when all of the source ports go down. To create an LFP group, use the **link-fault-propagation group** command. For example:

```
-> link-fault-propagation group 1
```

2 Associate source ports with the LFP group. To associate source ports to an LFP group, use the **link-fault-propagation group source** command. For example:

```
-> link-fault-propagation group 1 source port 1/1/2-5 2/1/3
```

3 Associate destination ports with the LFP group. To associate destination ports with an LFP group, use the **link-fault-propagation group destination** command. For example:

```
-> link-fault-propagation group 1 destination port 1/1/5-8 2/1/3
```

4 Configure the LFP wait-to-shutdown timer. This timer specifies the amount of time that LFP will wait before shutting down all the destination ports. To configure this timer value, use the **link-fault-propagation group wait-to-shutdown** command. For example:

```
-> link-fault-propagation group 1 wait-to-shutdown 70
```

Note. *Optional.* To verify the LFP configuration, use the **show link-fault-propagation group** command. For example:

```
-> show link-fault-propagation group
Group Id : 2
  Source Port(s)      : 0/1-2 1/1-5 1/7,
  Destination Port(s) : 0/3 1/10-13,
  Group-Src-Ports Status : up,
  Admin Status       : enable,
  Wait To Shutdown   : 10

Group Id : 6
  Source Port(s)      : 1/2 1/6 1/9,
  Destination Port(s) : 1/10-11 1/13,
  Group-Src-Ports Status : down,
  Admin Status       : disable,
  Wait To Shutdown   : 5

-> show link-fault-propagation group 2
Group Id : 2
  Source Port(s)      : 0/1-2 1/1-5 1/7,
  Destination Port(s) : 0/3 1/10-13,
  Group-Src-Ports Status : up,
  Admin Status       : enable,
  Wait To Shutdown   : 10
```

See the *OmniSwitch AOS Release 8 CLI Reference Guide* for more information about LFP commands.

LFP Application Example

This section provides an example of using LFP in a layer 2 network configuration, as shown in the following sample topology:

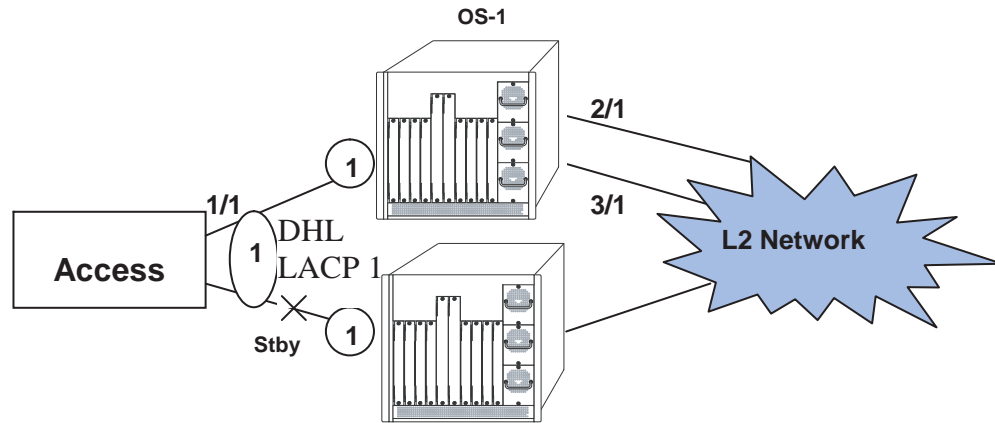

Link Fault Propagation - Application Example

In this example:

- When interfaces 2/1 and 3/1 on OS-1 are down, the access switch will keep interface 1/1 as active and traffic will still be forwarded to OS-1 even though it has no network connectivity.
- To allow the switch to use the standby interface the link on OS-1 would need to be disabled so that interface 1/1 on the access switch leaves the LACP group.

```
-> link-fault-propagation group 1 source port 2/1 3/1 destination linkagg 1
```

2 Configuring UDLD

UniDirectional Link Detection (UDLD) is a protocol for detecting and disabling unidirectional Ethernet fiber or copper links caused by mis-wiring of fiber strands, interface malfunctions, media converter faults, and so on. The UDLD operates at Layer 2 in conjunction with IEEE 802.3 - Layer 1 fault detection mechanisms.

UDLD is a lightweight protocol that can be used to detect and disable one-way connections before they create dangerous situations such as Spanning Tree loops or other protocol malfunctions. The protocol is mainly used to advertise the identities of all the UDLD-capable devices attached to the same LAN segment and to collect the information received on the ports of each device to determine whether the Layer 2 communication is functioning properly. All connected devices must support UDLD for the protocol to successfully identify and disable unidirectional links. When UDLD detects a unidirectional link, the protocol administratively shuts down the affected port and generates a trap to alert the user.

In This Chapter

This chapter describes how to configure UDLD parameters through the Command Line Interface (CLI). CLI commands are used in the configuration examples; for more details about the syntax of commands, see the *OmniSwitch AOS Release 8 CLI Reference Guide*.

Configuration procedures described in this chapter include the following:

- [“Configuring UDLD” on page 2-6.](#)
- [“Configuring the Operational Mode” on page 2-7.](#)
- [“Configuring the Probe-Timer” on page 2-7](#) to configure the probe-message advertisement timer.
- [“Configuring the Echo-Wait-Timer” on page 2-7](#) to configure the echo-based detection timer.
- [“Clearing UDLD Statistics” on page 2-8.](#)
- [“Verifying the UDLD Configuration” on page 2-8.](#)
- [“Verifying the UDLD Configuration” on page 2-8.](#)

UDLD Specifications

Platforms Supported	OmniSwitch 6860, 6860E
Maximum number of UDLD ports per system	Up to maximum physical ports per system

UDLD Defaults

Parameter Description	Command	Default
UDLD administrative state	udld	Disabled
UDLD status of a port	udld port	Disabled
UDLD operational mode	udld mode	Normal
Probe-message advertisement timer	udld probe-timer	15 seconds
Echo-based detection timer	udld echo-wait-timer	8 seconds

Quick Steps for Configuring UDLD

- 1 To enable the UDLD protocol on a switch, use the **udld** command. For example:

```
-> udld enable
```

- 2 To enable the UDLD protocol on a port, use the **udld port** command by entering **udld port**, followed by the slot and port number, and **enable**. For example:

```
-> udld port 1/1/6 enable
```

- 3 Configure the operational mode of UDLD by entering **udld port**, followed by the slot and port number, **mode**, and the operational mode. For example:

```
-> udld port 1/1/6 mode aggressive
```

- 4 Configure the probe-message advertisement timer on port 6 of slot 1 as 17 seconds using the following command:

```
-> udld port 1/1/6 probe-timer 17
```

Note. *Optional.* Verify the UDLD global configuration by entering the **show udld configuration** command or verify the UDLD configuration on a port by entering the **show udld configuration port** command. For example:

```
-> show udld configuration
```

```
Global UDLD Status : Disabled
```

```
-> show udld configuration port 1/1/6
```

```
Global UDLD Status: enabled
```

```
Port UDLD Status: enabled
```

```
Port UDLD State: bidirectional
```

```
UDLD Op-Mode: normal
```

```
Probe Timer (Sec): 20,
```

```
Echo-Wait Timer (Sec): 10
```

To verify the UDLD statistics of a port, use the **show udld statistics port** command. For example:

```
-> show udld statistics port 1/1/42
```

```
UDLD Port Statistics
```

```
Hello Packet Send      :8,
```

```
Echo Packet Send       :8,
```

```
Flush Packet Recvd     :0
```

```
UDLD Neighbor Statistics
```

```
Neighbor ID      Hello Pkts Recv      Echo Pkts Recv
```

```
-----+-----+-----
```

1	8	15
2	8	15
3	8	21
4	8	14
5	8	15
6	8	20

UDLD Overview

UDLD is a Layer 2 protocol used to examine the physical configuration connected through fiber-optic or twisted-pair Ethernet cables. When a port is affected and only a unidirectional link is working, UDLD detects and administratively shuts down the affected port, and alerts the user. Unidirectional links can create hazardous situations such as Spanning-Tree topology loops caused, for instance, by unwiring of fiber strands, interface malfunctions, faults of the media converter, and so on.

The UDLD feature is supported on the following port types:

- Copper ports
- Fiber ports

UDLD Operational Mode

UDLD supports two modes of operation:

- Normal mode
- Aggressive mode

UDLD works with the Layer 1 mechanisms to determine the physical status of a link. A unidirectional link occurs whenever the traffic sent from a local device is received by its neighbor; but the traffic from the neighbor is not received by the local device.

Normal Mode

In this mode, the protocol depends on explicit information instead of implicit information. If the protocol is unable to retrieve any explicit information, the port is not put in the shutdown state; instead, it is marked as **Undetermined**. The port is put in the shutdown state only when:

- It is explicitly determined that the link is defective
- When it is determined on the basis of UDLD-PDU processing that link has become unidirectional.

In any such state transition, a trap is raised.

Aggressive Mode

In this mode, UDLD checks whether the connections are correct and the traffic is flowing bidirectionally between the respective neighbors. The loss of communication with the neighbor is considered an event to put the port in shutdown state. Thus, if the UDLD PDUs are not received before the expiry of a timer, the port is put in the **UDLD-shutdown** state. Since the lack of information is not always due to a defective link, this mode is optional and is recommended only for point-to-point links.

UDLD shuts down the affected interface when one of these problems occurs:

- On fiber-optic or twisted-pair links, one of the interfaces cannot send or receive traffic.
- On fiber-optic or twisted-pair links, one of the interfaces is down while the other is up.
- One of the fiber strands in the cable is disconnected.

Mechanisms to Detect Unidirectional Links

The UDLD protocol is implemented to correct certain assumptions made by other protocols, and to help the Spanning Tree Protocol to function properly to avoid the creation of dangerous Layer 2 loops.

UDLD uses two basic mechanisms:

- It advertises the identity of a port and learns about its neighbors. This information about the neighbors is maintained in a cache table.
- It sends continuous echo messages in certain circumstances that require fast notifications or fast re-synchronization of the cached information.

Neighbor database maintenance

UDLD learns about other UDLD neighbors by periodically sending a Hello packet (also called an advertisement or probe) on every active interface to inform each device about its neighbors.

When the switch receives a Hello message, the switch caches the information until the age time expires. If the switch receives a new Hello message before the aging of an older cache entry, the switch replaces the older entry with the new one.

Whenever an interface is disabled and UDLD is running, or UDLD is disabled on an interface, or the switch is reset, UDLD clears all the existing cache entries for the interfaces that are affected by the configuration change. UDLD sends a message to the neighbors to flush the part of their caches affected by the status change. This UDLD message is intended to synchronize the caches.

Echo detection

UDLD depends on an echo-detection mechanism. UDLD restarts the detection window on its side of the connection and sends echo messages in response to the request, whenever a UDLD device learns about a new neighbor or receives a re-synchronization request from an out-of-sync neighbor. This behavior is the same on all UDLD neighbors because the sender of the echoes expects to receive an echo as a response.

If the detection window ends and no valid response is received, the link is shut down, depending on the UDLD mode. When UDLD is in normal mode, the link is considered to be undetermined and is not shut down. When UDLD is in aggressive mode, the link is considered to be unidirectional, and the interface is shut down.

In normal mode, if UDLD is in the advertisement or in the detection phase and all the neighbor cache entries are aged out, UDLD restarts the link-up sequence to re-synchronize with potentially out-of-sync neighbors.

In aggressive mode, if UDLD is in the advertisement or in the detection phase and all the neighbors of a port are aged out, UDLD restarts the link-up sequence to re-synchronize with potentially out-of-sync neighbors. UDLD shuts down the port, after the continuous messages, if the link state is undetermined.

Configuring UDLD

This section describes how to use Command Line Interface (CLI) commands to do the following:

- “Enabling and Disabling UDLD” on page 2-6.
- “Configuring the Operational Mode” on page 2-7.
- “Configuring the Probe-Timer” on page 2-7.
- “Configuring the Echo-Wait-Timer” on page 2-7.
- “Clearing UDLD Statistics” on page 2-8.
- “Verifying the UDLD Configuration” on page 2-8.

Note. See the “UDLD Commands” chapter in the *OmniSwitch AOS Release 8 CLI Reference Guide* for more information about UDLD CLI commands.

Enabling and Disabling UDLD

By default, UDLD is disabled on all switch ports. To enable UDLD on a switch, use the **udld** command. For example, the following command enables UDLD on a switch:

```
-> udld enable
```

To disable UDLD on a switch, use the **udld** command with the **disable** parameter. For example, the following command disables UDLD on a switch:

```
-> udld disable
```

Enabling UDLD on a Port

By default, UDLD is disabled on all switch ports. To enable UDLD on a port, use the **udld port** command. For example, the following command enables UDLD on port 3 of slot 1:

```
-> udld port 1/1/3 enable
```

To enable UDLD on multiple ports, specify a range of ports. For example:

```
-> udld port 1/1/6-10 enable
```

To disable UDLD on a port, use the **udld port** command with the **disable** parameter. For example, the following command disables UDLD on a range of ports:

```
-> udld port 1/5/21-24 disable
```

Configuring the Operational Mode

To configure the operational mode, use the **udld mode** command as shown:

```
-> udld mode aggressive
```

For example, to configure the mode for port 4 on slot 2, enter:

```
-> udld port 1/2/4 mode aggressive
```

To configure the mode for multiple ports, specify a range of ports. For example:

```
-> udld port 1/2/7-18 mode normal
```

Configuring the Probe-Timer

To configure the probe-message advertisement timer, use the **udld probe-timer** command as shown:

```
-> udld probe-timer 20
```

For example, to configure the probe-timer for port 3 on slot 6, enter:

```
-> udld port 1/6/3 probe-timer 18
```

To configure the probe-timer for multiple ports, specify a range of ports. For example:

```
-> udld port 1/1/8-21 probe-timer 18
```

Use the **no** form of this command to reset the timer. For example, the following command resets the timer for port 4 of slot 6:

```
-> no udld port 1/6/4 probe-timer
```

The following command resets the timer for multiple ports:

```
-> no udld port 1/1/8-21 probe-timer
```

Configuring the Echo-Wait-Timer

To configure the echo-based detection timer, use the **udld echo-wait-timer** command as shown:

```
-> udld echo-wait-timer 9
```

For example, to configure the echo-wait-timer for port 5 on slot 6, enter:

```
-> udld port 1/6/5 echo-wait-timer 12
```

To configure the echo-wait-timer for multiple ports, specify a range of ports. For example:

```
-> udld port 1/1/8-21 echo-wait-timer 9
```

Use the **no** form of this command to reset the timer. For example, the following command resets the timer for port 6 of slot 4:

```
-> no udld port 1/4/6 echo-wait-timer
```

The following command resets the timer for multiple ports:

```
-> no udld port 1/1/8-21 echo-wait-timer
```

Clearing UDLD Statistics

To clear the UDLD statistics, use the **clear uddl statistics port** command. For example, to clear the statistics for port 4 on slot 1, enter:

```
-> clear uddl statistics port 1/1/4
```

To clear the UDLD statistics on all the ports, enter:

```
-> clear uddl statistics
```

Verifying the UDLD Configuration

To display UDLD configuration and statistics information, use the show commands listed below:

show uddl configuration	Displays the global status of UDLD configuration.
show uddl configuration port	Displays the configuration information for all UDLD ports or for a particular UDLD port on the switch.
show uddl statistics port	Displays the UDLD statistics for a specific port.
show uddl neighbor port	Displays the UDLD neighbor ports.
show uddl status port	Displays the UDLD status for all ports or for a specific port.

For more information about the resulting display from these commands, see the *OmniSwitch AOS Release 8 CLI Reference Guide*. An example of the output for the **show uddl configuration port** and **show uddl statistics port** commands is also given in [“Quick Steps for Configuring UDLD”](#) on page 2-3.

3 Managing Source Learning

Transparent bridging relies on a process referred to as *source learning* to handle traffic flow. Network devices communicate by sending and receiving data packets that each contain a source MAC address and a destination MAC address. When packets are received on switch network interface (NI) module ports, source learning examines each packet and compares the source MAC address to entries in a MAC address database table. If the table does not contain an entry for the source address, then a new record is created associating the address with the port it was learned on. If an entry for the source address already exists in the table, a new one is not created.

Packets are also filtered to determine if the source and destination address are on the same LAN segment. If the destination address is not found in the MAC address table, then the packet is forwarded to all other switches that are connected to the same LAN. If the MAC address table does contain a matching entry for the destination address, then there is no need to forward the packet to the rest of the network.

In This Chapter

This chapter describes how to manage source learning entries in the switch MAC address table (often referred to as the *forwarding or filtering database*) through the Command Line Interface (CLI). CLI commands are used in the configuration examples; for more details about the syntax of commands, see the *OmniSwitch CLI Reference Guide*.

Configuration procedures described in this chapter include:

- [“Using Static MAC Addresses” on page 3-3.](#)
- [“Using Static Multicast MAC Addresses” on page 3-5.](#)
- [“Configuring MAC Address Table Aging Time” on page 3-7.](#)
- [“Configuring the Source Learning Status” on page 3-8.](#)
- [“Increasing the MAC Address Table Size” on page 3-9.](#)
- [“Displaying Source Learning Information” on page 3-10.](#)

Source Learning Specifications

The functionality described in this chapter is supported on the OmniSwitch unless otherwise stated in the following Specifications table or specifically noted within any section of this chapter.

Platforms Supported	OmniSwitch 6860, 6860E
Maximum number of learned MAC addresses when centralized MAC source learning mode is enabled	48K
Maximum number of learned MAC addresses when distributed MAC source learning mode is enabled.	48K

Source Learning Defaults

Parameter Description	Command	Default
Static MAC address operating mode	mac-learning static mac-address	bridging
MAC address aging timer	mac-learning aging-time	300 seconds
MAC source learning status per port	mac-learning	enabled
MAC source learning mode	mac-learning mode	centralized

MAC Address Table Overview

Source learning builds and maintains the MAC address table on each switch. New MAC address table entries are created in one of two ways: they are dynamically learned or statically assigned. Dynamically learned MAC addresses are those that are obtained by the switch when source learning examines data packets and records the source address and the port and VLAN it was learned on. Static MAC addresses are user defined addresses that are statically assigned to a port and VLAN using the **mac-learning static mac-address** command.

Accessing MAC Address Table entries is useful for managing traffic flow and troubleshooting network device connectivity problems. For example, if a workstation connected to the switch is unable to communicate with another workstation connected to the same switch, the MAC address table might show that one of these devices was learned on a port that belonged to a different VLAN or the source MAC address of one of the devices does not appear at all in the address table.

Using Static MAC Addresses

Static MAC addresses are configured using the **mac-learning static mac-address** command. These addresses direct network traffic to a specific port and VLAN. They are particularly useful when dealing with silent network devices. These types of devices do not send packets, so their source MAC address is never learned and recorded in the MAC address table. Assigning a MAC address to the silent device's port creates a record in the MAC address table and ensures that packets destined for the silent device are forwarded out that port.

When defining a static MAC address for a particular port and VLAN, consider the following:

- Configuring static MAC addresses is only supported on fixed ports.
- The specified port must already belong to the specified VLAN. Use the **vlan members untagged** command to assign a port to a VLAN before you configure the static MAC address.
- Only traffic from other ports associated with the same VLAN is directed to the static MAC address port.
- Static MAC addresses are **permanent** addresses. This means that a static MAC address remains in use even if the MAC ages out or the switch is rebooted.
- There are two types of static MAC address behavior supported: **bridging** (default) or **filtering**. Enter **filtering** to set up a denial of service to block potential hostile attacks. Traffic sent to or from a filtered MAC address is dropped. Enter **bridging** for regular traffic flow to or from the MAC address.
- If a packet received on a port associated with the same VLAN contains a source address that matches a static MAC address, the packet is discarded. The same source address on different ports within the same VLAN is not supported.
- If a static MAC address is configured on a port link that is down or disabled, an asterisk appears to the right of the MAC address in the display output. The asterisk indicates that this is an invalid MAC address. When the port link comes up, however, the MAC address is then considered valid and the asterisk no longer appears next to the address in the display.

Configuring Static MAC Addresses

To configure a permanent, bridging static MAC address, see the example below:

```
-> mac-learning vlan 1 port 1/1/1 static mac-address 00:00:02:CE:10:37 bridging
```

Use the **no** form of this command to clear MAC address entries from the table. :

```
-> no mac-learning vlan 1 port 1/1/1 static mac-address 00:00:02:CE:10:37 bridging
```

To verify static MAC address configuration and other table entries, use the **show mac-learning** command. For more information about this command, see the *OmniSwitch CLI Reference Guide*.

Static MAC Addresses on Link Aggregate Ports

Static MAC Addresses are not assigned to physical ports that belong to a link aggregate. Instead, they are assigned to a link aggregate ID that represents a collection of physical ports. This ID is specified at the time the link aggregate of ports is created.

To configure a static MAC address on a link aggregate ID 1 belong to VLAN 1 see the example below:

```
-> mac-learning vlan 1 linkagg 1 static mac-address 00:00:02:CE:10:37 bridging
```

For more information about configuring a link aggregate of ports, see [Chapter 9, “Configuring Static Link Aggregation”](#) and [Chapter 10, “Configuring Dynamic Link Aggregation.”](#)

Using Static Multicast MAC Addresses

Using static multicast MAC addresses allows you to send traffic intended for a single destination multicast MAC address to selected switch ports within a given VLAN. To specify which ports receive the multicast traffic, a static multicast address is assigned to each selected port for a given VLAN. The ports associated with the multicast address are then identified as egress ports. When traffic received on ports within the same VLAN is destined for the multicast address, the traffic is forwarded only on the egress ports that are associated with the multicast address.

The **mac-learning multicast mac-address** command is used to configure a static multicast MAC address. When defining this type of static MAC address for a particular port and VLAN, consider the following:

- A MAC address is considered a multicast MAC address if the least significant bit of the most significant octet of the address is enabled. For example, MAC addresses with a prefix of 01, 03, 05, 13, etc., are multicast MAC addresses.
- If a multicast prefix value is not present, then the address is treated as a regular MAC address and not allowed with the **mac-learning vlan multicast mac-address** command.
- The multicast addresses within the following ranges are not supported:
01:00:5E:00:00:00 to 01:00:5E:7F:FF:FF
01:80:C2:XX.XX.XX
33:33:XX:XX:XX:XX
- In addition to configuring the same static multicast address for multiple ports within a given VLAN, it is also possible to use the same multicast address across multiple VLANs.
- The specified port or link aggregate ID must already belong to the specified VLAN.

Configuring Static Multicast MAC Addresses

The **mac-learning multicast mac-address** command is used to define a destination multicast MAC address and assign the address to one or more egress ports within a specified VLAN. For example, the following command assigns the multicast address 01:25:9a:5c:2f:10 to port 1/24 in VLAN 20:

```
-> mac-learning vlan 20 port 1/1/1 multicast mac-address 01:25:9a:5c:2f:10
```

Use the **no** form of the **mac-learning multicast mac-address** command to delete static multicast MAC address entries:

```
-> no mac-learning vlan 20 port 1/1/1 multicast mac-address 01:25:9a:5c:2f:10
```

If a MAC address, port and VLAN ID are not specified with this form of the command, then all static multicast addresses are deleted. For example, the following command deletes all static MAC addresses, regardless of their port or VLAN assignments:

```
-> no mac-learning multicast
```

To verify the static MAC address configuration and other table entries, use the **show mac-learning** and **show mac-learning** commands. For more information about these commands, see the *OmniSwitch AOS Release 8 CLI Reference Guide*.

Static Multicast MAC Addresses on Link Aggregate Ports

Static multicast MAC addresses are not assigned to physical ports that belong to a link aggregate. Instead, they are assigned to a link aggregate ID that represents a collection of physical ports. This ID is specified at the time the link aggregate of ports is created and when using the **mac-address-table static-multicast** command.

To configure a static multicast MAC address on a link aggregate ID, use the **mac-learning multicast mac-address** command with the **linkagg** keyword to specify the link aggregate ID. For example, the following command assigns a static multicast MAC address to link aggregate ID 2 associated with VLAN 455:

```
-> mac-learning vlan 455 linkagg 2 multicast mac-address 01:95:2A:00:3E:4c
```

Configuring MAC Address Table Aging Time

Source learning also tracks MAC address age and removes addresses from the MAC address table that have aged beyond the aging timer value. When a device stops sending packets, source learning keeps track of how much time has passed since the last packet was received on the switch port of the device. When this amount of time exceeds the aging time value, the MAC is *aged out* of the MAC address table. Source learning always starts tracking MAC address age from the time since the last packet was received.

For example, the following sets the aging time for all VLANs to 1200 seconds (20 minutes):

```
-> mac-learning aging-time 1200
```

A MAC address learned on any VLAN port ages out when the time since a packet with the particular address was last seen on the port exceeds 1200 seconds.

Note. An inactive MAC address can take up to twice as long as the aging time value specified to age out of the MAC address table. For example, if an aging time of 60 seconds is specified, the MAC ages out any time between 60 and 120 seconds of inactivity.

To set the aging time back to the default value, use the **default** parameter. For example, the following sets the aging time for all VLANs back to the default value:

```
-> mac-learning aging-time default
```

To display the aging time value use the **show mac-learning aging-time** command. For more information about this command, see the *OmniSwitch CLI Reference Guide*.

Configuring the Source Learning Status

The source learning status for a port or link aggregate of ports is configurable using the **mac-learning** command. For example:

```
-> mac-learning port 1/1/10 disable
-> mac-learning port 1/1/15-20 disable
-> mac-learning linkagg 10 disable
```

To enable the source learning status for a port or link aggregate, use the **source-learning** command with the **enable** option. For example:

```
-> mac-learning port 1/1/10 enable
-> mac-learning port 1/1/15-20 enable
-> mac-learning linkagg 10 enable
```

Disabling source learning on a port or link aggregate is useful on a ring configuration, where a switch within the ring does not need to learn the MAC addresses that the same switch is forwarding to another switch within the ring. This functionality is also useful in Transparent LAN Service configurations, where the service provider device does not need to learn the MAC addresses of the customer network.

Configuring the source learning status is not allowed on the following types of switch ports:

- Ports enabled with Learned Port Security (LPS).
- Ports enabled with Universal Network Profile (UNP) functionality.
- Member ports of a link aggregate.

Consider the following guidelines when changing the source learning status for a port or link aggregate:

- Disabling source learning on a link aggregate disables MAC address learning on all member ports of the link aggregate.
- MAC addresses dynamically learned on a port or aggregate are cleared when source learning is disabled.
- Statically configured MAC addresses are not cleared when source learning is disabled for the port or aggregate. In addition, configuring a new static MAC address is allowed even when source learning is disabled.

Increasing the MAC Address Table Size

There are two source learning modes available for the OmniSwitch: centralized and distributed. Enabling the distributed mode for the switch increases the table size for the switch.

To enable the distributed MAC source learning mode for the chassis, use the **mac-learning mode** command. When distributed MAC source learning mode is disabled, the switch operates in the centralized MAC source learning mode (the default).

Enabling or disabling the distributed MAC source learning mode requires the following three steps:

- 1** Set the mode.
- 2** Enter the **write memory** command to save the switch configuration.
- 3** Reboot the switch.

For example:

```
-> mac-learning mode distributed  
  
WARNING: Source Learning mode has changed - must do write memory and reload  
  
-> write memory  
-> reload
```

Note. All three of the above configuration steps are required to enable or disable the MAC mode. If any of the above steps are skipped, the status of the mode is not changed.

Displaying Source Learning Information

To display MAC Address Table entries, statistics, and aging time values, use the show commands listed below:

show mac-learning	Displays a list of all MAC addresses known to the MAC address table, including static and multicast MAC addresses.
show mac-learning aging-time	Displays the current MAC address aging timer value by switch or VLAN.
show mac-learning mode	Displays the current status of the distributed MAC source learning mode.

For more information about the resulting displays from these commands, see the *OmniSwitch AOS Release 8 CLI Reference Guide*.

4 Configuring VLANs

In a flat bridged network, a broadcast domain is confined to a single LAN segment or even a specific physical location, such as a department or building floor. In a switch-based network, such as one comprised of Alcatel-Lucent switching systems, a broadcast domain, or VLAN can span multiple physical switches and can include ports from a variety of media types. For example, a single VLAN could span three different switches located in different buildings and include a variety of Ethernet port configurations, such as 802.1q tagged VLAN member ports and/or a link aggregate of ports.

In This Chapter

This chapter describes how to define and manage VLAN configurations through the Command Line Interface (CLI). CLI commands are used in the configuration examples; for more details about the syntax of commands, see the *OmniSwitch AOS Release 8 CLI Reference Guide*.

Configuration procedures described in this chapter include:

- [“Creating/Modifying VLANs” on page 4-4.](#)
- [“Assigning Ports to VLANs” on page 4-6.](#)
- [“Enabling/Disabling Spanning Tree for a VLAN” on page 4-8.](#)
- [“Enabling/Disabling Source Learning” on page 4-9.](#)
- [“Configuring VLAN IP Interfaces” on page 4-9.](#)
- [“Bridging VLANs Across Multiple Switches” on page 4-10.](#)
- [“Verifying the VLAN Configuration” on page 4-12.](#)

For information about Spanning Tree, see [Chapter 6, “Configuring Spanning Tree Parameters.”](#)

For information about routing, see [Chapter 16, “Configuring IP.”](#)

VLAN Specifications

The maximum limit values provided in the following Specifications table are subject to available system resources.

Platforms Supported	OmniSwitch 6860, 6860E
Maximum VLANs per switch	4K
Maximum Tagged VLANs per Port	4K (minus one default VLAN)
Maximum Untagged VLANs per Port	One untagged VLAN (default VLAN) per port.
Maximum VLAN Port Associations (VPA) per switch (Recommended)	8K

VLAN Defaults

Parameter Description	Command	Default
VLAN identifier (VLAN ID)	vlan	VLAN 1 predefined on each switch.
VLAN administrative state	vlan	Enabled
VLAN description	vlan name	VLAN ID
VLAN Spanning Tree state	spantree vlan admin-state	Enabled
VLAN IP router interface	ip interface	None
VLAN port associations	vlan members untagged	All ports initially associated with default VLAN 1.

Sample VLAN Configuration

The following steps provide a quick tutorial to create VLAN 100. Also included are steps to define a VLAN description, IP router interface, and static switch port assignments.

Note. Optional. Creating a new VLAN involves specifying a VLAN ID that is not already assigned to an existing VLAN. To determine if a VLAN already exists in the switch configuration, enter **show vlan**. If VLAN 100 does not appear in the **show vlan** output, then it does not exist on the switch. For example:

```
-> show vlan
vlan      type      admin   oper     ip      mtu      name
-----+-----+-----+-----+-----+-----+-----
1         std       Ena     Ena     Ena     1500    VLAN 1
4094     vcm       Ena     Ena     Dis     1500    VCM IPC
```

1 Create VLAN 100 with a description (for example, Finance IP Network) using the following command:

```
-> vlan 100 name "Finance IP Network"
```

2 Define an IP interface using the following command to assign an IP host address of 21.0.0.10 to VLAN 100 that enables forwarding of VLAN traffic to other subnets:

```
-> ip interface vlan_100_ip address 21.0.0.10 vlan 100
```

3 Assign switch ports 2 through 4 VLAN 100 using the following command:

```
-> vlan 100 members port 3/1/2-4 untagged
```

Note. Optional. To verify the VLAN 100 configuration, use the **show vlan** command. For example:

```
-> show vlan 100
Name                : Finance IP Network,
Type                : Static Vlan,
Administrative State : Enabled,
Operational State   : Disabled,
IP Router Port      : 21.0.0.10 255.0.0.0 forward e2,
IP MTU              : 1500
```

To verify that ports 1/3/2-4 were assigned to VLAN 100, use the **show vlan members** command. For example:

```
-> show vlan 100 members
port      type      status
-----+-----+-----
3/1/2     default  inactive
3/1/3     default  inactive
3/1/4     default  inactive
```

To verify the details about the specific VLAN port 3/2, use the **show vlan members** command with the **port** keyword and port number. For example:

```
-> show vlan 100 members port 3/1/2
type      : default,
status     : inactive,
vlan admin : disabled,
vlan oper  : disabled,
```

VLAN Management Overview

One of the main benefits of using VLANs to segment network traffic, is that VLAN configuration and port assignment is handled through switch software. This eliminates the need to physically change a network device connection or location when adding or removing devices from the VLAN broadcast domain. The OmniSwitch VLAN management software handles the following VLAN configuration tasks:

- Creating or modifying VLANs.
- Assigning or changing default VLAN port associations (VPAs).
- Enabling or disabling VLAN participation in the current Spanning Tree algorithm.
- Displaying VLAN configuration information.

In addition to the above tasks, VLAN management software tracks and reports the following information to other switch software applications:

- VLAN configuration changes, such as adding or deleting VLANs, modifying the status of VLAN properties (for example, administrative, Spanning Tree, and authentication status), changing the VLAN description, or configuring VLAN router interfaces.
- VLAN port associations triggered by VLAN management and other switch software applications, such as 802.1Q VLAN tagging.
- The VLAN operational state, which is inactive until at least one active switch port is associated with the VLAN.

Creating/Modifying VLANs

The initial configuration for all Alcatel-Lucent switches consists of a default VLAN 1 and all switch ports are initially assigned to this VLAN. When a switching module is added to the switch, the physical ports are also related to the assigned VLAN 1. If additional VLANs are not configured on the switch, then the entire switch is treated as one large broadcast domain. All ports receive traffic from all other ports.

In compliance with the IEEE 802.1Q standard, each VLAN is identified by a unique number, referred to as the “VLAN ID”. The user specifies a VLAN ID to create, modify or remove a VLAN and to assign switch ports to a VLAN. When a packet is received on a port, the VLAN ID of the port is inserted into the packet. The packet is then bridged to other ports that are assigned to the same VLAN ID. In essence, the VLAN broadcast domain is defined by a collection of ports and packets assigned to its VLAN ID.

The operational status of a VLAN remains inactive until at least one active switch port is assigned to the VLAN. This means that VLAN properties, such as Spanning Tree or router interfaces, also remain inactive. Ports are considered active if they are connected to an active network device. Non-active port assignments are allowed, but do not change the operational state of the VLAN.

Ports can be statically assigned to VLANs. When a port is assigned to a VLAN, a VLAN port association (VPA) is created and tracked by VLAN management switch software. For more information about VPAs, see [“Assigning Ports to VLANs” on page 4-6](#).

Adding/Removing a VLAN

To add a VLAN to the switch configuration, enter **vlan** followed by a unique VLAN ID, an optional administrative status, and an optional description. For example, the following command creates VLAN 755 with a description:

```
-> vlan 755 name "IP Finance Network"
```

By default, administrative status and Spanning Tree are enabled when the VLAN is created. The **name** parameter for VLAN is optional.

Note. Quotation marks are required if the description contains multiple words separated by spaces. If the description consists of only one word or multiple words separated by another character, such as a hyphen, then quotes are not required.

You can also specify a contiguous range of VLAN IDs by using a hyphen with the **vlan** command. For example, the following commands create VLANs 10 through 15 and 100 through 105 on the switch:

```
-> vlan 10-15 name "Marketing Network"
-> vlan 100-105 name "Marketing Network"
```

To remove a VLAN from the switch configuration, use the **no** form of the **vlan** command.

```
-> no vlan 200
-> no vlan 100-105
-> no vlan 10-15
```

When a VLAN is deleted, any router interfaces defined for the VLAN are removed and all VLAN port associations are dropped. If the VLAN deleted is the default VLAN for a port, the port returns to default VLAN 1. If the VLAN deleted is not a default VLAN, then the ports are directly detached from the VLAN. For more information about VLAN router interfaces, see [“Configuring VLAN IP Interfaces” on page 4-9](#).

To view a list of VLANs already configured on the switch, use the **show vlan** command. See [“Verifying the VLAN Configuration” on page 4-12](#) for more information.

Enabling/Disabling the VLAN Administrative Status

To enable or disable the administrative status for an existing VLAN, enter **vlan** followed by an existing VLAN ID and either **enable** or **disable**.

```
-> vlan 7 admin-state disable
-> vlan 1 admin-state enable
```

When the administrative status for a VLAN is disabled, VLAN port assignments are retained but traffic is not forwarded on these ports.

Modifying the VLAN Description

To change the description for a VLAN, enter **vlan** followed by an existing VLAN ID and the keyword **name** followed by the new description. For example, the following command changes the description for VLAN 455 to “Marketing IP Network”:

```
-> vlan 455 name "Marketing IP Network"
```

Assigning Ports to VLANs

The OmniSwitch supports static assignment of physical switch ports to a VLAN. Once the assignment occurs, a VLAN port association (VPA) is created and tracked by VLAN management software on each switch. To view current VLAN port assignments in the switch configuration, use the [show vlan members](#) command.

Methods for statically assigning ports to VLANs include the following:

- Using the [vlan members untagged](#) command to define a new configured default VLAN for fixed ports. See [“Changing the Default VLAN Assignment for a Port” on page 4-6](#).
- Using the [vlan members tagged](#) command to define 802.1Q-tagged VLANs for fixed ports. This method allows the switch to bridge traffic for multiple VLANs over one physical port connection. See [“Using 802.1Q Tagging” on page 4-7](#).
- Configuring ports as members of a link aggregate that is assigned to a configured default VLAN. (See [Chapter 9, “Configuring Static Link Aggregation,”](#) for more information.)

Changing the Default VLAN Assignment for a Port

Initially all switch ports are assigned to VLAN 1, which is also their *configured default* VLAN. When additional VLANs are created on the switch, ports are assigned to the VLANs so that traffic from devices connected to these ports is bridged within the VLAN domain.

To assign a switch port to a new default VLAN, use the [vlan members untagged](#) command. For example, the following command assigns port 5 to VLAN 955:

```
-> vlan 955 members port 2/1/5 untagged
```

When the [vlan members](#) command is used, the port's default VLAN assignment is changed to the specified VLAN. The previous default VLAN assignment for the port (for example, VLAN 1, VLAN 10 or VLAN 200) is dropped.

The [vlan members](#) command is also used to change the default VLAN assignment for an aggregate of ports. The link aggregate control number is specified instead of a port. For example, the following command assigns link aggregate 10 to VLAN 755:

```
-> vlan 755 members linkagg 10 untagged
```

For more information about configuring an aggregate of ports, see [Chapter 9, “Configuring Static Link Aggregation.”](#)

Use the **no** form of the [vlan members](#) command to remove a default VPA. When this is done, VLAN 1 is restored as the default VLAN for the port.

```
-> no vlan 955 members port 2/1/5
```

Using 802.1Q Tagging

Another method for assigning ports to VLANs involves configuring a switch port or link aggregate to process 802.1Q-tagged frames that contain a specific VLAN ID designation. This method, referred to as 802.1Q tagging (or trunking), allows a single network link to carry traffic for multiple VLANs.

The OmniSwitch implements the IEEE 802.1Q standard for sending frames through the network tagged with VLAN identification. This section details procedures for configuring and monitoring 802.1Q tagging on a single switch port or link aggregate group.

“Tagged” refers to four bytes of reserved space in the header of the packet. The four bytes of “tagging” are broken down as follows: the first two bytes indicate whether the packet is an 802.1Q packet, and the next two bytes carry the VLAN identification (VID) and priority.

When packets ingress the switch, they are classified into a VLAN based on their 802.1Q tag information.

- If the packet contains an 802.1Q tag, the VLAN ID in the tag must match either the default VLAN ID for the port or a VLAN ID for which the port is tagged. If there is no match, the packet is dropped.
- If the packet is not tagged at all, the packet is placed into the default VLAN to which the port that received the packet is assigned.

The following diagram illustrates a simple network by using tagged and untagged traffic:

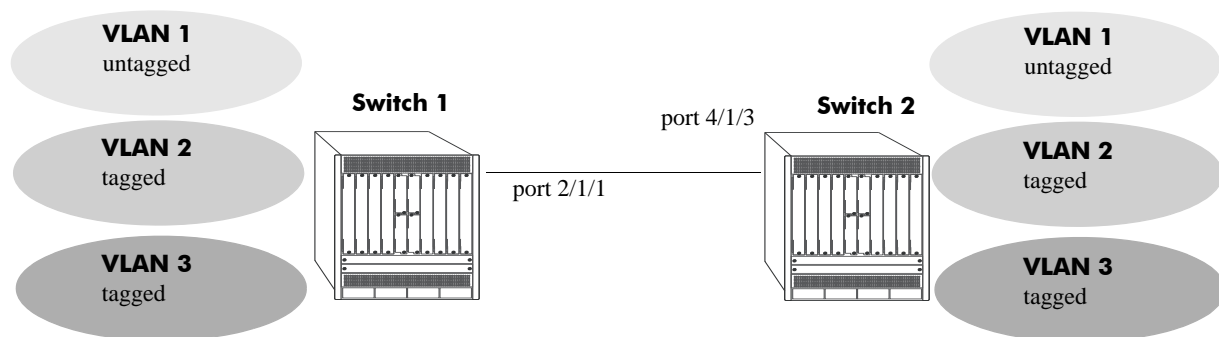

Tagged and Untagged Traffic Network (update)

Switch 1 and 2 have three VLANs, one for untagged traffic and two for tagged traffic. The ports connecting Switch 1 and 2 are configured in such a manner that the ports accept both tagged traffic for VLANs 2 and 3 and untagged traffic for VLAN 1.

A port can only be assigned to one untagged VLAN (in every case, this is the default VLAN configuration). In this example the default VLAN for port 2/1/1 and port 4/1/3 is VLAN 1. The port can be assigned to as many 802.1Q-tagged VLANs as necessary.

Configuring 802.1Q Tagging

To set a port to be a tagged port, use the `vlan members tagged` command and specify a VLAN identification (VID) number and a port number. For example, to configure port 4/1/3 to carry traffic for VLAN 5, enter the following command at the CLI prompt:

```
-> vlan 5 members port 4/1/3 tagged
```

Port 4/1/3 is now configured to carry packets tagged with VLAN 5, even though VLAN 5 is not the default VLAN for the port.

To enable tagging on link aggregation groups, enter the link aggregation group identification number in place of the port number, as shown:

```
-> vlan 5 members linkagg 8 tagged
```

For further information on creating link aggregation groups, see [Chapter 9, “Configuring Static Link Aggregation,”](#) or [Chapter 10, “Configuring Dynamic Link Aggregation.”](#)

To remove 802.1Q tagging from a selected port or link aggregate, use the **untagged** parameter.

```
-> vlan 5 members linkagg 8 untagged
```

To display all VLANs, enter the following command:

```
-> show vlan port
```

Note. The link aggregation group must be created first before it can be set to use 802.1Q tagging.

Enabling/Disabling Spanning Tree for a VLAN

The spanning tree operating mode set for the switch determines how VLAN ports are evaluated to identify redundant data paths. If the Spanning Tree switch operating mode is set to *flat*, then VLAN port connections are checked against other VLAN port connections for redundant data paths.

Note. The single flat mode STP instance is referred to as the CIST (Common and Internal Spanning Tree) instance.

In the flat mode, if the CIST instance is disabled, then it is disabled for all configured VLANs. However, disabling STP on an individual VLAN excludes only those VLAN ports from the flat STP algorithm.

If the Spanning Tree operating mode is set to *per-vlan* mode, there is a single Spanning Tree instance for each VLAN broadcast domain. Enabling or disabling STP on a VLAN in this mode includes or excludes the VLAN from the per-vlan STP algorithm.

The **spantree vlan admin-state** command is used to enable/disable a Spanning Tree instance for an existing VLAN. In the following examples, Spanning Tree is disabled on VLAN 255 and enabled on VLAN 755:

```
-> spantree vlan 255 admin-state disable
-> spantree vlan 755 admin-state enable
```

STP does not become operationally active on a VLAN unless the VLAN is operationally active, which occurs when at least one active port is assigned to the VLAN. Also, STP is enabled/disabled on individual ports. So even if STP is enabled for the VLAN, a port assigned to that VLAN must also have STP enabled. See [Chapter 6, “Configuring Spanning Tree Parameters.”](#)

Enabling/Disabling Source Learning

Source learning can be disabled on a VLAN. Disabling source learning can be beneficial in a ring topology. There is no limit on the number of ports that can belong to a VLAN that has source learning disabled, but it is recommended to include only the two ports connecting the switch to a ring.

To enable/disable source learning on a VLAN, use the **mac-learning static mac-address** command. For example, the following command disabled source learning on VLAN 10:

```
-> mac-learning vlan 10 disable
```

Disabling source learning on a VLAN causes the VLAN to be flooded with unknown unicast traffic.

Configuring VLAN IP Interfaces

Network device traffic is bridged (switched) at the Layer 2 level between ports that are assigned to the same VLAN. However, if a device needs to communicate with another device that belongs to a different VLAN, then Layer 3 routing is necessary to transmit traffic between the VLANs. Bridging makes the decision on where to forward packets based on the destination MAC address of the packet; routing makes the decision on where to forward packets based on the IP network address assigned to the packet (for example, 21.0.0.10).

Alcatel-Lucent switches support routing of IP traffic. A VLAN is available for routing when at least one IP interface is defined for that VLAN and at least one active port is associated with the VLAN. Up to eight IP interfaces can be configured for each VLAN.

If a VLAN does not have an IP interface, the ports associated with that VLAN are in essence firewalled from other VLANs. For information about configuring IP interfaces, see [Chapter 16, "Configuring IP."](#)

Bridging VLANs Across Multiple Switches

To create a VLAN *bridging domain* that extends across multiple switches:

- 1 Create a VLAN on each switch with the same VLAN ID number (for example, VLAN 10).
- 2 On each switch, assign the ports that provide connections to other switches to the VLAN created in Step 1.
- 3 On each switch, assign the ports that provide connections to end user devices (for example, workstations) to the VLAN created in Step 1.
- 4 Connect switches and end user devices to the assigned ports.

The following diagram shows the physical configuration of an example VLAN bridging domain:

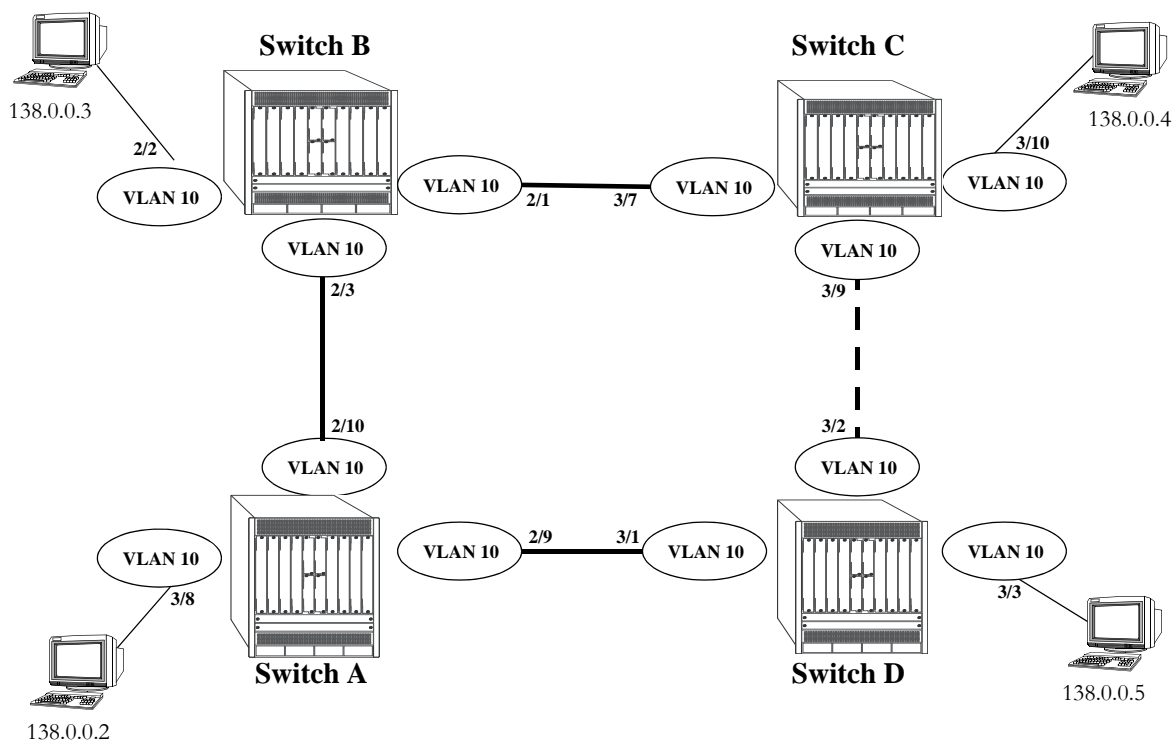

VLAN Bridging Domain: Physical Configuration (update)

In the above diagram, VLAN 10 exists on all four switches and the connection ports between these switches are assigned to VLAN 10. The workstations can communicate with each other because the ports to which they are connected are also assigned to VLAN 10. It is important to note that connection cables do not have to connect to the same port on each switch. The key is that the port must belong to the same VLAN on each switch. To carry multiple VLANs between switches across a single physical connection cable, use the 802.1Q tagging feature (see [“Using 802.1Q Tagging”](#) on page 4-7).

The connection between Switch C and D is shown with a broken line because the ports that provide this connection are in a blocking state. Spanning Tree is active by default on all switches, VLANs and ports. The Spanning Tree algorithm determined that if all connections between switches were active, a network loop would exist that could cause unnecessary broadcast traffic on the network. The path between Switch

C and D was shut down to avoid such a loop. See [Chapter 6, “Configuring Spanning Tree Parameters,”](#) for information about how Spanning Tree configures network topologies that are loop free.

The following diagram shows the same bridging domain example as seen by the end user workstations. Because traffic between these workstations is *bridged* across physical switch connections within the VLAN 10 domain, the workstations are basically unaware that the switches even exist. Each workstation believes that the others are all part of the same VLAN, even though they are physically connected to different switches.

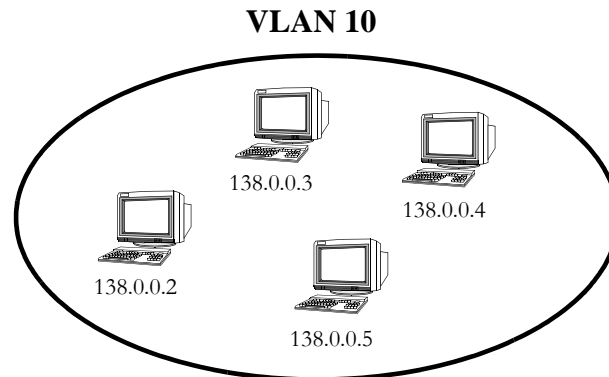

Creating a VLAN bridging domain across multiple switches allows VLAN members to communicate with each other, even if they are not connected to the same physical switch. This is how a logical grouping of users can traverse a physical network setup without routing and is one of the many benefits of using VLANs.

Verifying the VLAN Configuration

To display information about the VLAN configuration for a single switch use the show commands listed below:

show vlan	Displays a list of all VLANs configured on the switch and the status of related VLAN properties (for example, admin and Spanning Tree status and router port definitions).
show vlan members	Displays a list of VLAN port assignments.
show ip interface	Displays VLAN IP router interface information.

Understanding Port Output

Each line of the **show vlan members** output display corresponds to a single VLAN port association (VPA). In addition to showing the VLAN ID and port number, the VPA type and current status of each association are also provided.

The VPA type indicates that one of the following methods was used to create the VPA:

Type	Description
default	The port was statically assigned to the VLAN using the vlan members untagged command. The VLAN is now the port's configured default VLAN.
qtagged	The port was statically assigned to the VLAN using the vlan members tagged command. The VLAN is a static secondary VLAN for the 802.1Q tagged port.
mirror	The port is assigned to the VLAN because it is configured to mirror another port that is assigned to the same VLAN. For more information about the Port Mirroring feature, see Chapter 35, "Diagnosing Switch Problems."

The VPA status indicates one of the following:

Status	Description
inactive	Port is not active (administratively disabled, down, or nothing connected to the port) for the VPA.
blocking	Port is active, but not forwarding traffic for the VPA.
forwarding	Port is forwarding all traffic for the VPA.
filtering	Mobile port traffic is filtered for the VPA; only traffic received on the port that matches VLAN rules is forwarded. Occurs when a mobile port's VLAN is administratively disabled or the port's default VLAN status is disabled. Does not apply to fixed ports.

The following example displays VPA information for all ports in VLAN 200:

```
-> show vlan 200 members
  port      type      status
-----+-----+-----
   3/1/24   default   inactive
   5/1/12   qtagged   blocking
```

The above example output provides the following information:

- VLAN 200 is the configured default VLAN for port 3/1/24, which is currently not active.
- VLAN 200 is an 802.1Q-tagged VLAN for port 5/1/12, which is an active port but currently blocked from forwarding traffic.

For more information about the resulting displays from these commands, see the *OmniSwitch AOS Release 8 CLI Reference Guide*.

5 Configuring High Availability VLANs

High availability (HA) VLANs, unlike standard VLANs, allow you to send traffic intended for a single destination MAC address to multiple switch ports. These high availability VLANs can be used to manage server clusters.

In This Chapter

This chapter describes the basic components of high availability VLANs and how to configure them through the Command Line Interface (CLI). CLI commands are used in the configuration examples; for more details about the syntax of commands, see the *OmniSwitch CLI Reference Guide*.

Configuration procedures described in this chapter include:

- Creating a VLAN on [page 5-6](#).
- Adding and Removing Server Cluster Ports to a HA VLAN on [page 5-7](#).
- Assigning and Modifying Server Cluster Mode on [page 5-7](#).
- Assigning and Removing MAC addresses to a HA VLAN on [page 5-8](#).

Note. You can also configure and monitor high availability VLANs with WebView, Alcatel-Lucent's embedded web-based device management application. WebView is an interactive and easy-to-use GUI that can be launched from OmniVista or a web browser. Please refer to WebView online documentation for more information on configuring and monitoring high availability VLANs with WebView.

High Availability VLANs Specifications

The table below lists specifications for high availability VLAN software.

Platforms Supported	OmniSwitch 6860, 6860E
Maximum high availability VLANs per switch	32

High Availability Default Values

The table below lists default values for high availability VLAN software.

Parameter Description	Command	Default Value/Comments
Server cluster admin state of the server cluster	<code>server-cluster</code>	admin-state - enable
Server cluster id and mode	<code>server-cluster</code>	mode - L2
Mac address of the server cluster	<code>server-cluster mac-address</code>	None
IP address of the server cluster	<code>server-cluster ip</code>	IP address is configurable only for L3 clusters.
Configure the port/linkagg of a server cluster	<code>server-cluster port</code> <code>server-cluster linkagg</code>	None

Quick Steps for Creating High Availability VLANs

Follow the steps below for a quick tutorial on configuring high availability (HA) VLANs. Additional information on how to configure each command is given in the sections that follow.

1 Create a server cluster that will become the HA VLAN by using the command `server-cluster` and configure the mode. For example:

```
-> server-cluster 1 name l2_cluster mode l2
```

2 Create a default VLAN for the HA VLAN ports with the `vlan` command as shown below:

```
-> vlan 10
```

3 Assign member ports to the new default VLAN with the `vlan members untagged` command as shown below:

```
-> vlan 10 members port 1/1/3 untagged
-> vlan 10 members port 1/1/4 untagged
-> vlan 10 members port 1/1/5 untagged
```

4 Assign mac-address for the new server cluster by using the command `server-cluster mac-address`. For example:

```
-> server-cluster 1 vlan 10 port 1/1/3-5 mac-address 01:00:11:22:33:44
```

Note. Optional. You can display the configuration of high availability VLANs with the `show server-cluster` command. For example:

```
-> show server-cluster 1
Cluster Id : 1,
Cluster Name : L2-cluster,
Cluster Mode : L2,
Cluster Mac-address : 01:10:11:22:33:44,
Cluster Vlan : 12,
Administrative State: Enabled,
Operational State : Disabled,
Operational Flag : VPA is not forwarding
Multi-Chassis Status           : N/A
Multi-Chassis OutOfSync Reason  : N/A
VFL Status                     : N/A
```

An example of what these commands look like entered sequentially on the command line:

```
-> server-cluster 1 mode L2
-> vlan 10
-> vlan 10 members port 1/1/3 untagged
-> vlan 10 members port 1/1/4 untagged
-> vlan 10 members port 1/1/5 untagged
-> server-cluster 1 vlan 10 port 1/1/3-5 mac-address 01:00:11:22:33:44
```

High Availability VLAN Overview

High availability (HA) VLANs send traffic intended for a single destination MAC address to multiple switch ports. An HA VLAN is configured by creating a standard VLAN and then assigning ports to the VLAN. Once these types of ports are assigned, the standard VLAN automatically becomes an HA VLAN. When this occurs, standard VLAN commands no longer apply.

Destination MAC addresses (unicast and multicast) are also assigned to high availability VLANs. These addresses identify ingress port traffic that the switch will send out on all egress ports that belong to the same VLAN.

In addition to assigning ingress and egress ports, tagging inter-switch link ports with an HA VLAN ID is allowed. Ingress port traffic destined for an HA VLAN MAC address is sent out on all egress *and* inter-switch link ports that belong to the same VLAN. Traffic forwarded on inter-switch link ports is done so in accordance with the Spanning Tree state of the port.

A high availability VLAN hosts multiple instances of applications like e-commerce applications, critical databases, business applications etc and supports redundancy. Each instance may get all the service requests and based on a shared algorithm, HA VLAN decides on which requests a particular node has to handle. Apart from service request paths, the nodes are internally connected to share information related to the service load information, service request data and service availability on other nodes.

The HA VLAN feature on the OmniSwitch provides an elegant and flexible way to connect the server cluster nodes directly to the ingress network. This involves multicasting the service requests on the configured ports. The multicast criteria is configurable based on destination MAC and destination IP address. Egress ports can be statically configured on a server cluster or they can be registered by IGMP reports. The server cluster feature on the OmniSwitch multicast the incoming packets based on the server cluster configuration on the ports associated with the server cluster.

High Availability VLAN Operational Mode

There are typically two modes of implementation of server clusters in HA VLAN.

- Layer 2 - The server cluster is attached to a L2 switch on which the frames destined to the cluster MAC address are to be flooded on all interfaces. For more information see [“Example 1: Layer 2 Server Cluster”](#) on page 5-9
- Layer 3 - The server cluster is attached to a L3 switch on which the frames destined to the server cluster IP address are to be routed to the server cluster IP and then flooded on all interfaces. For more information see [“Example 2: Layer 3 Server Cluster”](#) on page 5-11.

Note. The L2 mode is currently supported in AOS using the static mac-address command and L3 mode by the static ARP command.

Traffic Flows in High Availability VLAN

The figure below shows how ingress traffic is handled by high availability VLANs.

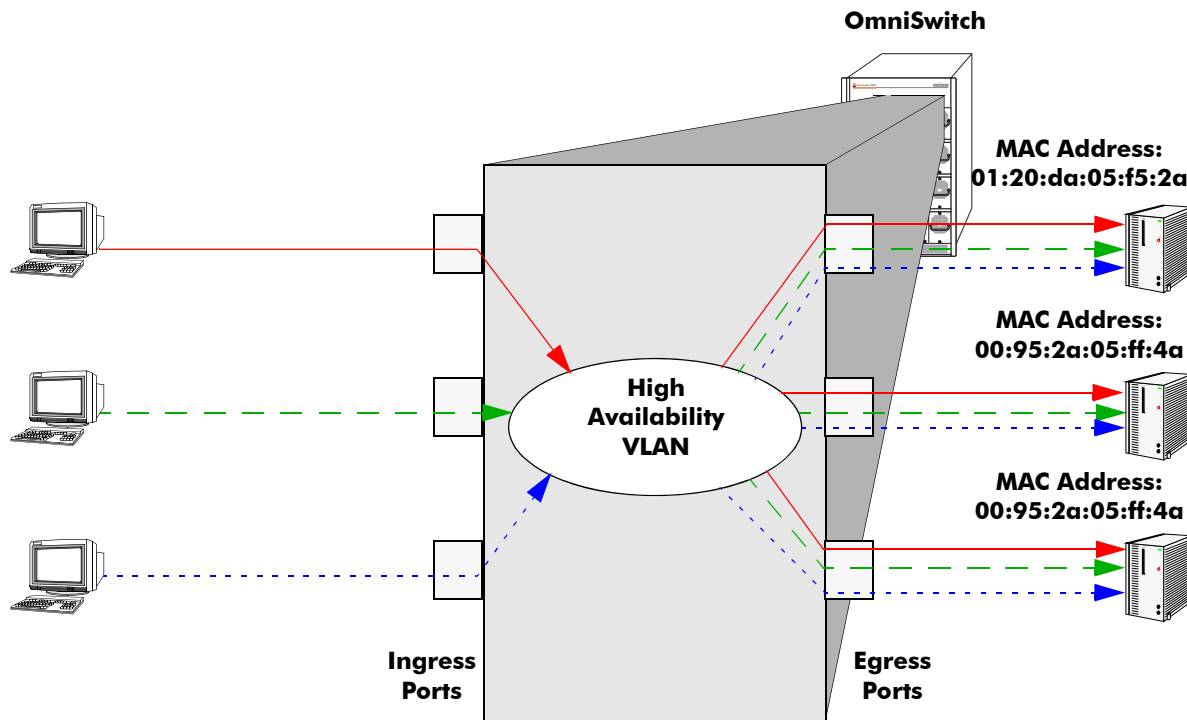

Example of an L2 server cluster - Ingress to Egress Port Flow

In the above example, packets received on the ingress ports that are destined for the high availability VLAN MAC address are sent out the egress ports that are members of the same VLAN. The MAC address is virtual to the server cluster, individual servers may have different physical MAC address. Since all three servers are connected to egress ports, they all receive the ingress port traffic. This provides a high level of availability in that if one of the server connections goes down, the other connections still forward traffic to one of the redundant servers.

Configuring High Availability VLANs on a Switch

This section describes how to use the Command Line Interface (CLI) commands to configure high availability (HA) VLANs on a switch. For a brief tutorial on configuring HA VLANs, see [“Quick Steps for Creating High Availability VLANs” on page 5-3](#).

When configuring HA VLANs, you must perform the following steps:

- 1 Create a VLAN.** To create a VLAN use the **vlan** command, which is described in [“Creating and Deleting VLANs” on page 5-6](#).
- 2 Assign VLAN member ports.** To assign member ports to the VLAN, use the **vlan members untagged** command which is described in [“Changing the Default VLAN Assignment for a Port” on page 4-6](#)
- 3 Create a server cluster and configure the mode.** To create a server cluster and configure the cluster mode, use the **server-cluster** command which is described in [“Adding and Removing Server Cluster Ports” on page 5-7](#)
- 4 Assign MAC Addresses.** To assign MAC addresses to the HA VLAN server cluster, use the **server-cluster mac-address** command, which is described in [“Assigning and Removing MAC Addresses” on page 5-8](#).

Note. Use the **show server-cluster** command to verify the HA VLAN configuration on the switch. See [“Displaying High Availability VLAN Status” on page 5-16](#) for more information.

Creating and Deleting VLANs

The following subsections describe how to create and delete a VLAN with the **vlan** command.

Note. This section provides only a basic description of creating and deleting VLANs. For a complete description of configuring and monitoring VLANs on a switch, please refer to [Chapter 4, “Configuring VLANs.”](#)

Creating a VLAN

To create a new VLAN use the **vlan** command by entering **vlan** followed by the VLAN ID number. For example, to create a VLAN with a VLAN ID number of 10 enter

```
-> vlan 10
```

You can also specify the administrative status and a name for the VLAN with the **vlan** command. For example, to administratively enable (the default) a VLAN when you configure it enter **vlan** followed by the VLAN ID number and **enable**.

For example, to create VLAN 10 and administratively enable it enter

```
-> vlan 10 enable
```

Deleting a VLAN

To delete a VLAN use the **no** form of the **vlan** command by entering **no vlan** followed by the VLAN's ID number. For example, to delete high availability VLAN 10 enter:

```
-> no vlan 10
```

Adding and Removing Server Cluster Ports

The following subsections describe how to assign to and remove ingress ports from a high availability VLAN with the **server-cluster port** command.

Assigning Ports to a Server Cluster

To assign server cluster ports to a high availability VLAN use the **server-cluster port/linkagg** command. For example, to assign port 1/1/21 to server cluster "1", enter the commands as:

```
-> server-cluster 1 port 1/1/21
```

To assign linkagg "1" to server cluster "3", enter the commands as:

```
-> server-cluster 3 linkagg 1
```

Removing Ports from a Server Cluster

To remove server cluster ports from a high availability VLAN use the **no** form of **server-cluster port/linkagg** command. For example,

```
-> no server-cluster 1 port 1/1/21  
-> no server-cluster 3 linkagg 1
```

Assigning and Modifying Server Cluster Mode

The following subsections describe how to assign to and remove egress ports from a high availability VLAN with the **server-cluster** command.

Assigning L2 Mode to a Server Cluster

To assign L2 mode to a high availability VLAN use the **server-cluster id** command. For example, to assign "L2" mode to the server cluster "1", enter the command as:

```
-> server-cluster 1 mode l2
```

If you want a name to be assigned along with the cluster mode, enter the commands as:

```
-> server-cluster 1 name l2_cluster mode l2
```

Assigning L3 Mode to a Server Cluster

A cluster can be assigned an IP address and an ARP entry mac-address. Each cluster must have a unique IP-address. IP address is configurable only for L3 clusters.

To assign L3 mode to a high availability VLAN use the **server-cluster id** command. For example, to assign "L3" mode to the server cluster "2", enter the command as:

```
-> server-cluster 2 mode l3  
-> server-cluster 5 port all
```

To assign L3 mode to linkaggs, enter the commands as:

```
-> server-cluster 3 linkagg 1
-> server-cluster 4 linkagg 1-3
```

To remove server cluster from a high availability VLAN, use the **no** form of the command. For example,

```
-> no server-cluster 1
-> no server-cluster 2
```

Assigning and Removing MAC Addresses

The following subsections describe how to assign and remove MAC addresses from a high availability VLAN with the **server-cluster mac-address** command. Traffic that is received on ingress ports that contains a destination MAC address that matches the high availability VLAN address is sent out all egress ports that belong to the high availability VLAN.

Assigning MAC Addresses

To assign a MAC address to a high availability VLAN, use the **server-cluster mac-address** command by entering **server-cluster mac-address**, followed by the VLAN's ID number, **mac**, and the MAC address. Note that both unicast and multicast addresses are supported.

For example, to assign the MAC address 00:25:9a:5c:2f:10 to high availability VLAN 20 you would enter:

```
-> server-cluster mac-address vlan 20 mac 00:25:9a:5c:2f:10
```

To add more than one MAC address to a high availability VLAN, enter each address on the same command line separated by a space. For example, to assign MAC addresses 00:25:9a:5c:2f:11, 00:25:9a:5c:12, and 01:00:00:3f:4c:10, to high availability VLAN 30, you would enter:

```
-> server-cluster mac-address vlan 30 mac 00:25:9a:5c:2f:11 00:25:9a:5c:12
01:00:00:3f:4c:10.
```

Removing MAC Addresses

To remove a MAC address associated with a high availability VLAN, use the **no** form of the **server-cluster mac-address** command. For example, the following command removes MAC address 00:25:9a:5c:2f:10 from VLAN 20:

```
-> no server-cluster mac-address vlan 20 no mac 00:25:9a:5c:2f:10
```

To remove more than one MAC address from a high availability VLAN using a single command, enter each address on the same command line separated by a space. For example, to remove MAC addresses 00:25:9a:5c:2f:11, 00:25:9a:5c:12, and 01:00:00:3f:4c:10, from high availability VLAN 30, you would enter:

```
-> server-cluster mac-address vlan 30 no mac 00:25:9a:5c:2f:11 00:25:9a:5c:12
01:00:00:3f:4c:10.
```

Note. Removing the last MAC address from an HA VLAN is not allowed. Deleting the VLAN is required when there is only one MAC address left.

Application Examples

This section contains the following HAVLAN application examples:

- “Example 1: Layer 2 Server Cluster” on page 5-9.
- “Example 2: Layer 3 Server Cluster” on page 5-11.
- “Example 3: Layer 3 Server Cluster with IP Multicast Address to Cluster (IGMP)” on page 5-13.

Example 1: Layer 2 Server Cluster

In the following example, the MAC address can be unicast or L2 multicast or IP multicast.

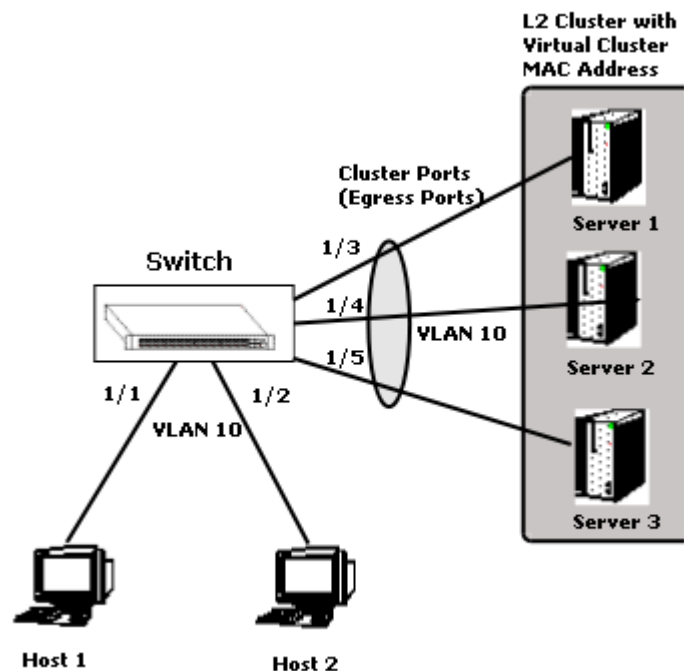

Switch connected to an L2 server cluster through 3 ports (1/1/3, 1/1/4, 1/1/5)

- A server cluster can be configured with a unique MAC address and a VLAN with a port list
- The traffic which ingresses on 1/1/1 or 1/1/2 destined to the server cluster MAC address and the VLAN is forwarded to all the egress ports configured.(1/1/3,1/1/4,1/1/5).
- Here the ingress ports must be in the same VLAN as the server cluster VLAN and egress ports and other traffic must be switched according to the normal switching logic.

Configuration Example

In this example, a packet can be an L2 or IP switched packet and Egress port can also be a linkagg port.

1 Create a server cluster that will become the HA VLAN by using the command **server-cluster** and configure the mode. For example:

```
-> server-cluster 1 mode l2
```

- 2 Create a default VLAN for the HA VLAN ports with the **vlan** command as shown below:

```
-> vlan 10
```

- 3 Assign member ports to the new default VLAN with the **vlan members untagged** command as shown below:

```
-> vlan 10 members port 1/1/3 untagged
-> vlan 10 members port 1/1/4 untagged
-> vlan 10 members port 1/1/5 untagged
```

- 4 Assign mac-address for the new server cluster by using the command **server-cluster mac-address**. For example:

```
-> server-cluster 1 vlan 10 port mac-address 01:00:11:22:33:44
```

Note. *Optional.* You can display the configuration of high availability VLANs with the **show server-cluster** command. For example:

```
-> show server-cluster 1
Cluster Id : 1,
Cluster Name : L2-cluster,
Cluster Mode : L2,
Cluster Mac-address : 01:10:11:22:33:44,
Cluster Vlan : 12,
Administrative State: Enabled,
Operational State : Disabled,
Operational Flag : VPA is not forwarding
```

An example of what these commands look like entered sequentially on the command line:

```
-> server-cluster 1 mode L2
-> vlan 10
-> vlan 10 members port 1/1/3 untagged
-> vlan 10 members port 1/1/4 untagged
-> vlan 10 members port 1/1/5 untagged
-> server-cluster 1 vlan 10 port 1/1/3-5 mac-address 01:00:11:22:33:44
```

Example 2: Layer 3 Server Cluster

In this example, A server cluster is configured with a unique IP address and a static ARP entry (cluster MAC) and a port list. Here, the server cluster IP address must be a unicast address.

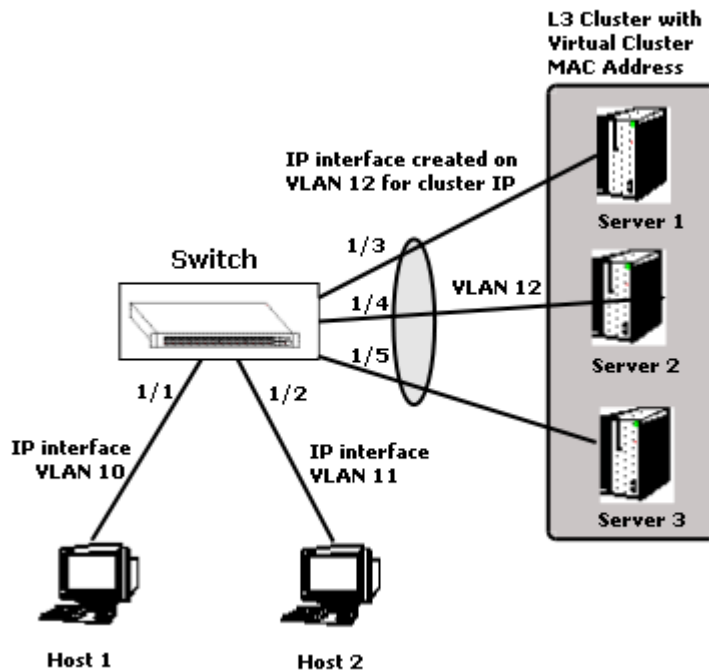

Switch connected to an L3 server cluster through 3 ports (1/3,1/4,1/5)

- The traffic which ingresses on 1/1/1 or 1/1/2 destined to the server cluster IP is routed to all the egress ports configured (1/1/3,1/1/4,1/1/5). The ingress ports are on a different VLAN as the server cluster IP interface.
- However, all the egress ports need to be in the same VLAN as the IP interface of server cluster. The other traffic must be switched according to the normal switching/routing logic.
- Egress port can be a linkagg port as well.

Configuration Example

In this example, a packet is an L3 or IP switched packet.

1 Create a server cluster that will become the HA VLAN by using the command **server-cluster** and configure the mode. For example:

```
-> server-cluster 2 mode L3
```

2 Create a default VLAN for the HA VLAN ports with the **vlan** command. For example:

```
-> vlan 12
```

3 Assign member ports to the new default VLAN with the **vlan members untagged** command. For example:

```
-> vlan 12 members port 1/1/3 untagged
-> vlan 12 members port 1/1/4 untagged
-> vlan 12 members port 1/1/5 untagged
```

4 Assign an IP address for the by using the **ip interface** command. For example:

```
-> ip interface "vlan 12"  
-> ip interface "vlan 12" address 10.135.33.13/24 vlan 12
```

5 Assign mac-address for the new server cluster by using the command **server-cluster mac-address**. For example:

```
-> server-cluster 2 ip 10.135.33.12 mac-address static 01:00:5e:22:33:44
```

Note. Optional. You can display the configuration of high availability VLANs with the **show server-cluster** command. For example:

```
-> show server-cluster 2  
Cluster Id : 2,  
Cluster Name : L3-cluster,  
Cluster Mode : L3,  
Cluster Mac-address : 01:10:11:22:33:44,  
Cluster Vlan : 12,  
Administrative State: Enabled,  
Operational State : Enabled,  
Operational Flag : -
```

An example of what these commands look like entered sequentially on the command line:

```
-> server-cluster 2 mode L3  
-> vlan 12  
-> vlan 12 members port 1/1/3 tagged  
-> vlan 12 members port 1/1/4 tagged  
-> vlan 12 members port 1/1/5 tagged  
-> ip interface "vlan 12"  
-> ip interface "vlan 12" address 10.135.33.13/24 vlan 12  
-> server-cluster 2 ip 10.135.33.12 mac-address static 01:00:5e:22:33:44
```

Example 3: Layer 3 Server Cluster with IP Multicast Address to Cluster (IGMP)

This example shows that a server cluster can be configured with a unique IP address and a IP multicast address. For this scenario, the server cluster IP address needs to be a unicast address and the MAC address (ARP entry) can be unicast or L2 multicast or IP multicast. The MAC address must be configured through CLI ARP resolution to a server cluster MAC, and must be configured before actual routing

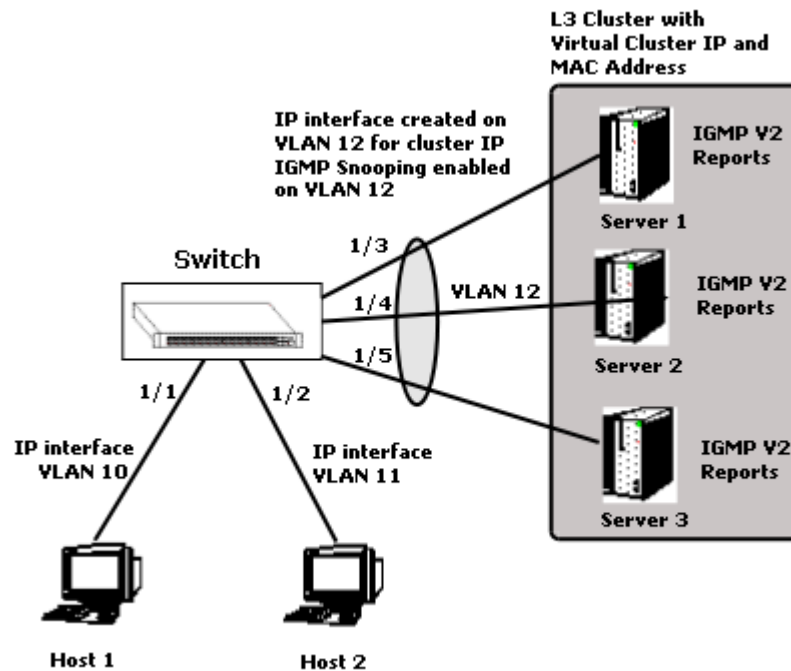

Switch connected to an L3 server cluster (IGMP) through 3 ports (1/3,1/4,1/5)

- There is no provision for port list configuration and Ports are derived dynamically using the IGMP snooping of the reports from the server cluster (IGMP v2 reports).
- The traffic which ingresses on 1/1 or 1/2 destined to the server cluster IP is routed to all the ports which are members of the IP multicast group of the server cluster.
- The ingress ports is on a different VLAN as the server cluster IP interface. Join and Leave messages keep updating the egress port list. However all the egress ports need to be in the same VLAN as the IP interface of server cluster.
- The other traffic is switched according to the normal switching/routing logic.
- Egress port can be a linkagg port as well.

Note. When a server cluster tries to send a bridged or routed packet to itself, a copy of the packet goes back to the sender's (server cluster) port.

Configuration Example

In this example, a packet is an L3 IP switched packet and Egress port can also be a linkagg port.

1 Create a server cluster that will become the HA VLAN by using the command **server-cluster** and configure the mode. For example:

```
-> server-cluster 3 mode L3
```

2 Create a default VLAN for the HA VLAN ports with the **vlan** command as shown below:

```
-> vlan 12
```

3 Assign member ports to the new default VLAN with the **vlan members untagged** command as shown below:

```
-> vlan 12 members port 1/1/3 untagged
-> vlan 12 members port 1/1/4 untagged
-> vlan 12 members port 1/1/5 untagged
```

4 Assign mac-address for the new server cluster by using the command **server-cluster mac-address**. For example:

```
-> server-cluster 3 ip 10.135.33.12 mac-address static 01:00:11:22:33:44
```

5 If you want to assign a dynamic mac-address for the server cluster, enter the command as follows:

```
-> server-cluster 3 ip 10.135.33.12 mac-address dynamic
```

6 Enable the admin state of the IP multicast by using the **ip multicast admin-state enable** command. IP multicast admin state must be enabled for the IGMP reports to be processed., else the cluster will be operationally down.

```
-> ip multicast admin-state enable
-> server-cluster 3 igmp-mode enable
-> server-cluster 3 ip-multicast 225.0.0.23
```

When IGMP mode is enabled for the server cluster, all static ports will be reset in igmp mode.

Note. Optional. You can display the configuration of high availability VLANs with the **show server-cluster** command. For example:

```
-> show server-cluster 3
Cluster Id           : 3,
Cluster Name        : -,
Cluster Mode        : L3,
Cluster IP          : 10.135.33.12,
Cluster Mac-Address : 01:00:11:22:33:44,
Cluster Mac Type    : Static,
IGMP-Mode           : Enabled,
Cluster Multicast IP : 225.0.0.23,
Administrative State : Enabled,
Operational State   : Disabled,
Operational Flag    : No IGMP members
```

An example of what these commands look like entered sequentially on the command line:

```
-> server-cluster 3 mode L3
-> vlan 12
-> vlan 12 members port 1/1/3 untagged
-> vlan 12 members port 1/1/4 untagged
-> vlan 12 members port 1/1/5 untagged
-> server-cluster 3 ip 10.135.33.12 mac-address static 01:00:11:22:33:44
-> ip multicast admin-state enable
-> server-cluster 3 igmp-mode enable
-> server-cluster 3 ip-multicast 225.0.0.23
```

Note. In order to process IGMP reports, it is required to enable IP multicast by using the **ip multicast admin-state enable** command.

Displaying High Availability VLAN Status

You can use CLI **show** commands to display the current configuration and statistics of high availability VLANs on a switch. These commands include the following:

- show server-cluster** Displays the server clusters configured in the system.
- show vlan** Displays a list of all VLANs configured on the switch and the status of related VLAN properties (for example, admin and Spanning Tree status and router port definitions).
- show vlan members** Displays a list of VLAN port assignments.

To display the status and configuration of high availability VLANs you use the **show server-cluster** command. To display the status and configuration of all high availability VLANs on a switch enter:

```
-> show server-cluster
```

A screen similar to the following will be displayed:

```
-> show server-cluster
```

Legend: * = not valid

Cluster	Mode	Vlan	Mac Address	Ip Address	IGMP Address	Name
* 10	L2	100	01:10:11:22:33:44	-	-	cluster1
11	L2	100	01:10:11:22:33:44	-	-	cluster2
12	L2	100	01:10:11:22:33:44	-	-	-
13	L3	-	01:12:11:22:33:44	10.135.33.203	-	-
* 14	L3	-	01:12:11:22:33:45	10.135.33.203	--	-
15	L3	-	01:00:5e:00:00:44	10.135.33.203	225.0.1.2	cluster-igmp

To display the status and configuration of a single high availability VLAN cluster enter **show server-cluster** followed by the server cluster ID number. For example, to display the status and configuration of high availability server cluster id "1" enter

```
-> show server-cluster 1
```

A screen similar to the following will be displayed:

```
-> show server-cluster 1
```

```
Cluster Id : 1,
Cluster Name : L2-cluster,
Cluster Mode : L2,
Cluster Mac-address : 01:10:11:22:33:44,
Cluster Vlan : 12,
Administrative State: Enabled,
Operational State : Disabled,
Operational Flag : VPA is not forwarding
```

Note. For more information on the CLI commands, See the *OmniSwitch AOS Release 8 CLI Reference Guide*

6 Configuring Spanning Tree Parameters

The Spanning Tree Algorithm and Protocol (STP) is a self-configuring algorithm that maintains a loop-free topology on a network. STP helps to provide data path redundancy and network scalability. The OmniSwitch STP implementation, based on the IEEE 802.1D standard, distributes the Spanning Tree load between the primary management module and the network interface modules. This functionality improves network robustness by providing a Spanning Tree that continues to respond to BPDUs (Bridge Protocol Data Unit) and port link up and down states in the event of a fail over to a backup management module or switch.

Alcatel-Lucent's distributed implementation also incorporates the following Spanning Tree features:

- Configures a physical topology into a single Spanning Tree to ensure that there is only one data path between any two switches.
- Supports fault tolerance within the network topology. The Spanning Tree is reconfigured in the event of a data path or bridge failure or when a new switch is added to the topology.
- Supports two Spanning Tree operating modes: *flat* (single STP instance per switch) and *per-VLAN* (single STP instance per VLAN). The per-VLAN mode can be configured to inter-operate with the proprietary Per-VLAN Spanning Tree (PVST+) feature of Cisco.
- Supports three Spanning Tree Algorithms; 802.1D (STP), 802.1w (RSTP), and 802.1Q 2005 (MSTP).
- Allows 802.1Q tagged ports and link aggregate logical ports to participate in the calculation of the STP topology.
- Provides loop-guard security to prevent network loops caused due to inconsistencies in data traffic.

The Distributed Spanning Tree software is active on all switches by default. As a result, a loop-free network topology is automatically calculated based on default Spanning Tree bridge, VLAN, and port parameter values. It is only necessary to configure the Spanning Tree parameters to change how the topology is calculated and maintained.

In This Chapter

This chapter provides an overview about how Spanning Tree works and how to configure Spanning Tree parameters through the Command Line Interface (CLI). CLI commands are used in the configuration examples; for more details about the syntax of commands, see the *OmniSwitch AOS Release 8 CLI Reference Guide*.

Configuration procedures described in this chapter include:

- Selecting the Spanning Tree operating mode (flat or per-VLAN) on [page 6-21](#).
- Configuring Spanning Tree bridge parameters on [page 6-26](#).
- Configuring Spanning Tree port parameters on [page 6-34](#).
- Configuring an example Spanning Tree topology on [page 6-44](#).

Spanning Tree Specifications

Platforms Supported	OmniSwitch 6860, 6860E
IEEE Standards supported	802.1d—Media Access Control (MAC) Bridges 802.1s—Multiple Spanning Trees 802.1w—Rapid Spanning Tree Protocol
Spanning Tree operating modes supported	Flat mode—one spanning tree instance per switch Per-VLAN mode—one spanning tree instance per VLAN
Spanning Tree port eligibility	Fixed ports 802.1Q tagged ports Link aggregate of ports
Maximum VLAN Spanning Tree instances per switch.	100 (per-VLAN mode)
Maximum flat mode Multiple Spanning Tree Instances (MSTI) per switch	16 MSTI, in addition to the Common and Internal Spanning Tree instance (also referred to as MSTI 0).

Spanning Tree Bridge Parameter Defaults

Parameter Description	Command	Default
Spanning Tree operating mode	spantree mode	Per-VLAN (a separate Spanning Tree instance for each VLAN)
PVST+ status	spantree pvst+compatibility	Disabled
Spanning Tree status for a VLAN instance	spantree vlan admin-state	Enabled
Spanning Tree protocol	spantree protocol	RSTP (802.1w)
BPDU switching status	spantree bpdu-switching	Disabled
Priority value for the Spanning Tree instance	spantree priority	32768
Hello time interval between each BPDU transmission	spantree hello-time	2 seconds
Maximum aging time allowed for Spanning Tree information learned from the network	spantree max-age	20 seconds
Spanning Tree port state transition time	spantree forward-delay	15 seconds
Path cost mode	spantree path-cost-mode	Auto (16-bit in per-VLAN mode and STP or RSTP flat mode, 32-bit in MSTP flat mode)
Automatic VLAN Containment	spantree auto-vlan-containment	Disabled
Spanning Tree loop-guard	spantree loop-guard	Disabled

Spanning Tree Port Parameter Defaults

Parameter Description	Command	Default
Status for a specific VLAN instance	spantree vlan	Enabled
Path cost for a specific VLAN instance	spantree vlan path-cost	0
Port state management mode	spantree cist mode spantree loop-guard	Dynamic (Spanning Tree Algorithm determines port state)
Port priority value	spantree priority	7
Port connection type for a specific VLAN instance	spantree vlan connection	auto point to point
Type of BPDU to be used on a port when per vlan PVST+ mode is enabled	spantree pvst+compatibility	auto (IEEE BPDUs are used until a PVST+ BPDU is detected)

Multiple Spanning Tree (MST) Region Defaults

Although the following parameter values are specific to MSTP, they are configurable regardless of which mode (flat or per-VLAN) or protocol is active on the switch.

Parameter Description	Command	Default
The MST region name	spantree mst region name	blank
The revision level for the MST region	spantree mst region revision-level	0
The maximum number of hops authorized for the region	spantree mst region max-hops	20
The number of Multiple Spanning Tree Instances (MSTI)	spantree msti	0 (flat mode instance)
The VLAN to MSTI mapping	spantree msti vlan	All VLANs are mapped to the Common Internal Spanning Tree (CIST) instance

Spanning Tree Overview

Alcatel-Lucent switches support the use of the 802.1D Spanning Tree Algorithm and Protocol (STP), the 802.1w Rapid Spanning Tree Algorithm and Protocol (RSTP), and the 802.1Q 2005 Multiple Spanning Tree Protocol (MSTP).

RSTP expedites topology changes by allowing blocked ports to transition directly into a forwarding state, bypassing listening and learning states. This provides rapid reconfiguration of the Spanning Tree in the event of a network path or device failure.

The 802.1w standard is an amendment to the 802.1D document, thus RSTP is based on STP. Regardless of which one of these two protocols a switch or VLAN is running, it can successfully interoperate with other switches or VLANs.

802.1Q 2005 is a new version of MSTP that combines the 802.1D 2004 and 802.1S protocols. This implementation of 802.1Q 2005 also includes improvements to edge port configuration and provides administrative control to restrict port role assignment and the propagation of topology change information through bridge ports.

MSTP is an enhancement to the 802.1Q Common Spanning Tree (CST), which is provided when an Alcatel-Lucent switch is running in the flat Spanning Tree operating mode. The flat mode applies a single spanning tree instance across all VLAN port connections on a switch. MSTP allows the configuration of Multiple Spanning Tree Instances (MSTIs) in addition to the CST instance. Each MSTI is mapped to a set of VLANs. As a result, the flat mode can now support the forwarding of VLAN traffic over separate data paths.

This section provides a Spanning Tree overview based on RSTP operation and terminology. Although MSTP is based on RSTP, see [“MST General Overview” on page 6-13](#) for specific information about configuring MSTP.

How the Spanning Tree Topology is Calculated

The *tree* consists of links and bridges that provide a single data path that spans the bridged network. At the base of the tree is a *root bridge*. One bridge is elected by all the bridges participating in the network to serve as the root of the tree. After the root bridge is identified, STP calculates the best path that leads from each bridge back to the root and blocks any connections that would cause a network loop.

To determine the best path to the root, STP uses the *path cost* value, which is associated with every port on each bridge in the network. This value is a configurable weighted measure that indicates the contribution of the port connection to the entire path leading from the bridge to the root.

In addition, a *root path cost* value is associated with every bridge. This value is the sum of the path costs for the port that receives frames on the best path to the root (this value is zero for the root bridge). The bridge with the lowest root path cost becomes the *designated bridge* for the LAN, as it provides the shortest path to the root for all bridges connected to the LAN.

During the process of calculating the Spanning Tree topology, each port on every bridge is assigned a *port role* based on how the port and/or its bridge participates in the active Spanning Tree topology.

The following table provides a list of port role types and the port and/or bridge properties that the Spanning Tree Algorithm examines to determine which role to assign to the port.

Role	Port/Bridge Properties
Root Port	Port connection that provides the shortest path (lowest path cost value) to the root. The root bridge does not have a root port.
Designated Port	The designated bridge provides the LAN with the shortest path to the root. The designated port connects the LAN to this bridge.
Backup Port	Any operational port on the designated bridge that is not a root or designated port. Provides a backup connection for the designated port. A backup port can only exist when there are redundant designated port connections to the LAN.
Alternate Port	Any operational port that is not the root port for its bridge and its bridge is not the designated bridge for the LAN. An alternate port offers an alternate path to the root bridge if the root port on its own bridge goes down.
Disabled Port	Port is not operational. If an active connection does come up on the port, it is assigned an appropriate role.

Note. The distinction between a backup port and an alternate port was introduced with the IEEE 802.1w standard to help define rapid transition of an alternate port to a root port.

The role a port plays or can potentially play in the active Spanning Tree topology determines the port operating state; *discarding*, *learning*, or *forwarding*. The *port state* is also configurable and it is possible to enable or disable the administrative status of port and/or specify a forwarding or blocking state that is only changed through user intervention.

The Spanning Tree Algorithm only includes ports in its calculations that are operational (link is up) and have an enabled administrative status. The following table compares and defines 802.1D and 802.1w port states and their associated port roles:

STP Port State	RSTP Port State	Port State Definition	Port Role
Disabled	Discarding	Port is down or administratively disabled and is not included in the topology.	Disabled
Blocking	Discarding	Frames are dropped, nothing is learned or forwarded on the port. Port is temporarily excluded from topology.	Alternate, Backup
Learning	Learning	Port is learning MAC addresses that are seen on the port and adding them to the bridge forwarding table, but not transmitting any data. Port is included in the active topology.	Root, Designated
Forwarding	Forwarding	Port is transmitting and receiving data and is included in the active topology.	Root, Designated

Once the Spanning Tree is calculated, there is only one root bridge, one designated bridge for each LAN, and one root port on each bridge (except for the root bridge). Data travels back and forth between bridges over forwarding port connections that form the best, non-redundant path to the root. The active topology ensures that network loops do not exist.

Bridge Protocol Data Units (BPDU)

Switches send layer 2 frames, referred to as Configuration Bridge Protocol Data Units (BPDU), to relay information to other switches. The information in these BPDU is used to calculate and reconfigure the Spanning Tree topology. A Configuration BPDU contains the following information that pertains to the bridge transmitting the BPDU:

Root ID	The Bridge ID for the bridge that this bridge believes is the root.
Root Path Cost	The sum of the Path Costs that lead from the root bridge to this bridge port. The Path Cost is a configurable parameter value. The IEEE 802.1D standard specifies a default value that is based on port speed. See “Configuring Port Path Cost” on page 6-37 for more information.
Bridge ID	An eight-byte hex value that identifies this bridge within the Spanning Tree. The first two bytes contain a configurable priority value and the remaining six bytes contain a bridge MAC address. See “Configuring the Bridge Priority” on page 6-28 for more information. Each switch chassis is assigned a dedicated base MAC address. This is the MAC address that is combined with the priority value to provide a unique Bridge ID for the switch. For more information about the base MAC address, see the appropriate Hardware Users Guide for the switch.
Port ID	A 16-bit hex value that identifies the bridge port that transmitted this BPDU. The first 4 bits contain a configurable priority value and the remaining 12 bits contain the physical switch port number. See “Configuring Port Priority” on page 6-36 for more information.

The sending and receiving of Configuration BPDU between switches participating in the bridged network constitute the root bridge election; the best path to the root is determined and then advertised to the rest of the network. BPDU provide enough information for the STP software running on each switch to determine the following:

- Which bridge serves as the root bridge.
- The shortest path between each bridge and the root bridge.
- Which bridge serves as the designated bridge for the LAN.
- Which port on each bridge serves as the root port.
- The port state (forwarding or discarding) for each bridge port based on the role the port plays in the active Spanning Tree topology.

The following events trigger the transmitting and/or processing of BPDU in order to discover and maintain the Spanning Tree topology:

- When a bridge first comes up, it assumes it is the root and starts transmitting Configuration BPDU on all its active ports advertising its own bridge ID as the root bridge ID.

- When a bridge receives BPDU on its root port that contains more attractive information (higher priority parameters and/or lower path costs), it forwards this information on to other LANs to which it is connected for consideration.
- When a bridge receives BPDU on its designated port that contains information that is less attractive (lower priority values and/or higher path costs), it forwards its own information to other LANs to which it is connected for consideration.

STP evaluates BPDU parameter values to select the best BPDU based on the following order of precedence:

- 1 The lowest root bridge ID (lowest priority value, then lowest MAC address).
- 2 The best root path cost.
- 3 If root path costs are equal, the bridge ID of the bridge sending the BPDU.
- 4 If the previous three values tie, then the port ID (lowest priority value, then lowest port number).

When a topology change occurs, such as when a link goes down or a switch is added to the network, the affected bridge sends Topology Change Notification (TCN) BPDU to the designated bridge for its LAN. The designated bridge then forwards the TCN to the root bridge. The root then sends out a Configuration BPDU and sets a Topology Change (TC) flag within the BPDU to notify other bridges that there is a change in the configuration information. Once this change is propagated throughout the Spanning Tree network, the root stops sending BPDU with the TC flag set and the Spanning Tree returns to an active, stable topology.

Note. You can restrict the propagation of TCNs on a port. To restrict TCN propagation on a port, see [“Configuring STP Port Parameters” on page 6-34](#).

Loop-guard on OmniSwitch

STP relies on continuous reception or transmission of BPDUs based on the port role. The designated port or primary port transmits BPDUs, and the non-designated ports receive BPDUs. When one of the non-designated ports in a spanning tree network stop receiving BPDUs, then the STP conceives that the network is loop free. However, when a non-designated (**Alternate**, **Root**, or **Backup**) port becomes designated and moves to a forwarding state, a loop is created in the network.

With Loop Guard, if a switch stops receiving BPDUs on a non-designated port, the switch places the port into the STP loop-inconsistent blocking state thus preventing the occurrence of loop in the network.

Loop-guard can be configured on individual ports on per-port or per-VLAN basis. A port can have both roles:

- Designated
- Non-designated for mutually exclusive set of VLANs or MSTP-instances (in MSTP mode)

If loop-guard is enabled on the port, it does not affect the forward or blocking state for a designated port. In case of BPDU timeout, if a loop-guard enabled port fails to receive three consecutive BPDUs, STP converts the port explicitly to a blocked port.

When loop-guard is enabled, if a switch stops receiving BPDUs on a non-designated port, the switch places the port into the STP loop-inconsistent blocking state.

By default, loop-guard is disabled on all the switch ports. User can configure loop-guard on any port

irrespective of its STP state or role. However, the feature functions only on non-designated (Alternate, Root, or Backup) STP ports.

Note.

- In the **flat** mode, as there is a single STP instance on all the VLANs, the loop-guard state of the ports is same across all the VLANs on the switch.
 - In **MSTP** mode, there is a single STP instance for each MSTI instance. In this case, loop-guard state of port is same across all the VLANs of a given MSTP instance. Hence if a loop-guard error occurs on any single port, it affects all the other ports related to the MSTI.
 - In **1X1** mode, there is a single STP instance assigned for each VLAN. Hence if a loop-guard error occurs on any single VLAN, it does not affect the other VLANs.
-

Topology Examples

The following diagram shows an example of a physical network topology that incorporates data path redundancy to ensure fault tolerance. These redundant paths, however, create loops in the network configuration. If a device connected to Switch A sends broadcast packets, Switch A floods the packets out all of its active ports. The switches connected to Switch A in turn floods the broadcast packets out their active ports, and Switch A eventually receives the same packets back and the cycle starts over again. This causes severe congestion on the network, often referred to as a *broadcast storm*.

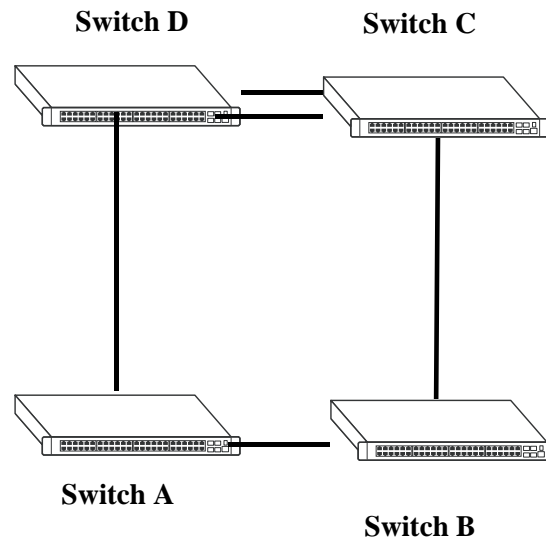

Physical Topology Example

The Spanning Tree Algorithm prevents network loops by ensuring that there is always only one active link between any two switches. This is done by transitioning one of the redundant links into a blocking state, leaving only one link actively forwarding traffic. If the active link goes down, then the Spanning Tree transitions one of the blocked links to the forwarding state to take over for the downed link. If a new switch is added to the network, the Spanning Tree topology is automatically recalculated to include the monitoring of links to the new switch.

The following diagram shows the logical connectivity of the same physical topology as determined by the Spanning Tree Algorithm:

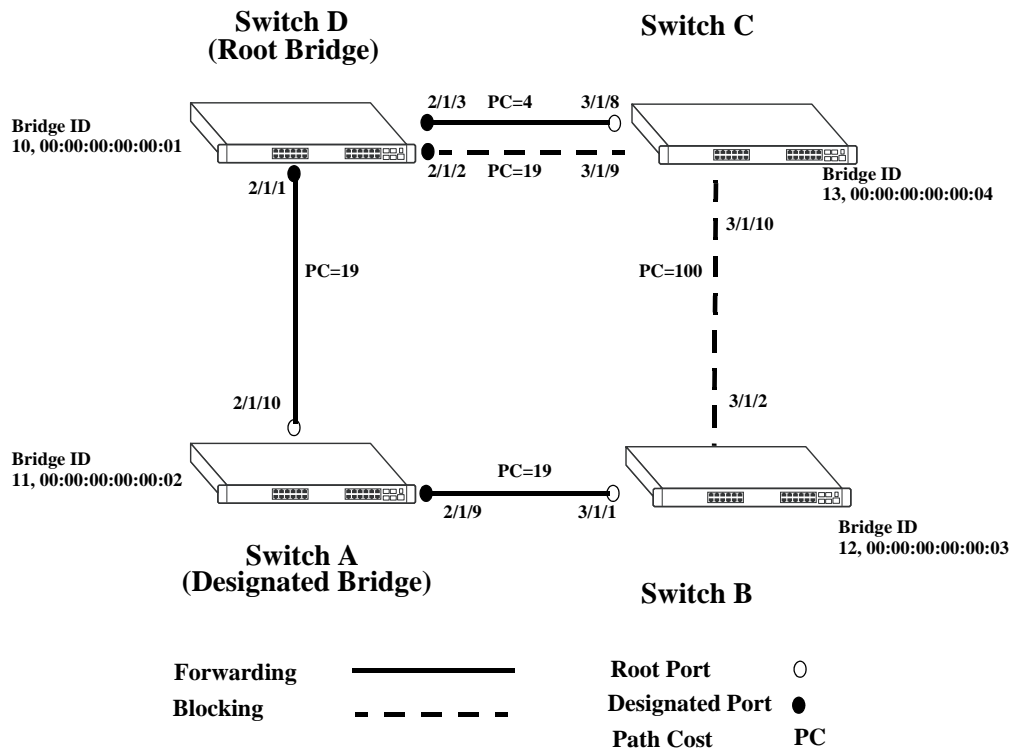

Active Spanning Tree Topology Example

In the above active Spanning Tree topology example, the following configuration decisions were made as a result of calculations performed by the Spanning Tree Algorithm:

- Switch D is the root bridge because its bridge ID has a priority value of 10 (the lower the priority value, the higher the priority the bridge has in the Spanning Tree). If all four switches had the same priority, then the switch with the lowest MAC address in its bridge ID would become the root.
- Switch A is the designated bridge for Switch B, because it provides the best path for Switch B to the root bridge.
- Port 2/1/9 on Switch A is a designated port, because it connects the LAN from Switch B to Switch A.
- All ports on Switch D are designated ports, because Switch D is the root and each port connects to a LAN.
- Ports 2/1/10, 3/1/1, and 3/1/8 are the root ports for Switches A, B, and C, respectively, because they offer the shortest path towards the root bridge.
- The port 3/1/9 connection on Switch C to port 2/1/2 on Switch D is in a discarding (blocking) state, as the connection these ports provides is redundant (backup) and has a higher path cost value than the 2/1/3 to 3/1/8 connection between the same two switches. As a result, a network loop is avoided.
- The port 3/1/2 connection on Switch B to port 3/1/10 on Switch C is also in a discarding (blocking) state, as the connection these ports provides has a higher path cost to root Switch D than the path between Switch B and Switch A. As a result, a network loop is avoided.

MST General Overview

The Multiple Spanning Tree (MST) feature allows for the mapping of one or more VLANs to a single Spanning Tree instance, referred to as a Multiple Spanning Tree Instance (MSTI), when the switch is running in the flat Spanning Tree mode. MST uses the Multiple Spanning Tree Algorithm and Protocol (MSTP) to define the Spanning Tree path for each MSTI. In addition, MSTP provides the ability to group switches into MST Regions. An MST Region appears as a single, flat Spanning Tree instance to switches outside the region.

This section provides an overview of the MST feature that includes the following topics:

- [“How MSTP Works” on page 6-13.](#)
- [“Comparing MSTP with STP and RSTP” on page 6-16.](#)
- [“What is a Multiple Spanning Tree Instance \(MSTI\)” on page 6-16.](#)
- [“What is a Multiple Spanning Tree Region” on page 6-17.](#)
- [“What is the Internal Spanning Tree \(IST\) Instance” on page 6-18.](#)
- [“What is the Common and Internal Spanning Tree Instance” on page 6-18.](#)
- [“MST Configuration Overview” on page 6-18.](#)

How MSTP Works

MSTP, as defined in the IEEE 802.1Q 2005 standard, is an enhancement to the IEEE 802.1Q Common Spanning Tree (CST). The CST is a single spanning tree that uses 802.1D (STP) or 802.1w (RSTP) to provide a loop-free network topology.

The Alcatel-Lucent flat spanning tree mode applies a single CST instance on a per switch basis. The per-VLAN mode is an Alcatel-Lucent proprietary implementation that applies a single spanning tree instance on a per VLAN basis. MSTP is only supported in the flat mode and allows for the configuration of additional Spanning Tree instances instead of just the one CST.

On Alcatel-Lucent MSTP flat mode switches, the CST is represented by the Common and Internal Spanning Tree (CIST) instance 0 and exists on all switches. Up to 17 instances, including the CIST, are supported. Each additional instance created is referred to as a Multiple Spanning Tree Instance (MSTI). An MSTI represents a configurable association between a single Spanning Tree instance and a set of VLANs.

Note. Although MSTP provides the ability to define MSTIs while running in the flat mode, port state and role computations are automatically calculated by the CST algorithm across all MSTIs. However, it is possible to configure the priority and/or path cost of a port for a particular MSTI so that a port remains in a forwarding state for an MSTI instance, even if it is blocked as a result of automatic CST computations for other instances.

The following diagrams help to further explain how MSTP works by comparing how port states are determined on per-VLAN STP/RSTP mode, flat mode STP/RSTP, and flat mode MSTP switches.

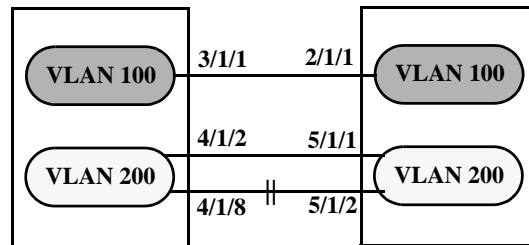

Per-VLAN Mode STP/RSTP

In the above per-VLAN mode example:

- Both switches are running in the per-VLAN mode (one Spanning Tree instance per VLAN).
- VLAN 100 and VLAN 200 are each associated with their own Spanning Tree instance.
- The connection between 3/1/1 and 2/1/1 is left in a forwarding state because it is part of the VLAN 100 Spanning Tree instance and is the only connection for that instance.

Note. If additional switches containing a VLAN 100 are connected to the switches in this diagram, then the 3/1/1 to 2/1/1 port connection gets into blocking state. The port connection is converted to blocking state, only if the VLAN 100 Spanning Tree instance determines it is required, to avoid a network loop.

- The connections between 4/1/8 and 5/1/2 and 5/1/2 and 5/1/1 are seen as redundant because they are both controlled by the VLAN 200 Spanning Tree instance and connect to the same switches. The VLAN 200 Spanning Tree instance determines which connection provides the best data path and transitions the other connection to a blocking state.

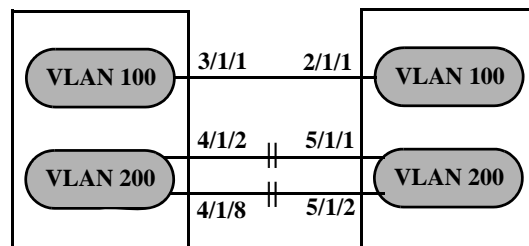

Flat Mode STP/RSTP (802.1D/802.1w)

In the above flat mode STP/RSTP example:

- Both switches are running in the flat mode. As a result, a single flat mode Spanning Tree instance applies to the entire switch and compares port connections across VLANs to determine which connection provides the best data path.
- The connection between 3/1/1 and 2/1/1 is left forwarding because the flat mode instance determined that this connection provides the best data path between the two switches.
- The 4/1/8 to 5/1/2 connection and the 4/1/2 to 5/1/1 connection are considered redundant connections so they are both blocked in favor of the 3/1/1 to 2/1/1 connection.

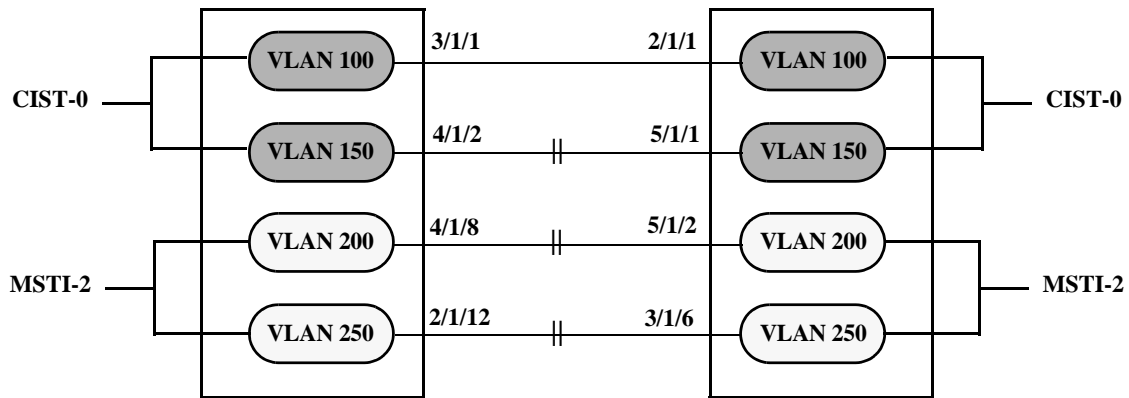

Flat Mode MSTP

In the above flat mode MSTP example:

- Both switches are running in the flat mode and using MSTP.
- VLANs 100 and 150 are *not* associated with an MSTI. They are controlled by the default CIST instance 0 that exists on every switch.
- VLANs 200 and 250 are associated with MSTI 2 so their traffic can traverse a path different from that determined by the CIST.
- Ports are blocked the same way they were blocked in the flat mode STP/RSTP example; all port connections are compared to each other across VLANs to determine which connection provides the best path.

However, because VLANs 200 and 250 are associated to MSTI 2, it is possible to change the port path cost for ports 2/1/12, 3/1/6, 4/1/8 and/or 5/1/2 so that they provide the best path for MSTI 2 VLANs, but do not carry CIST VLAN traffic or cause CIST ports to transition to a blocking state.

Another alternative is to assign all VLANs to an MSTI, leaving no VLANs controlled by the CIST. As a result, the CIST BPDU contains only MSTI information.

See [“Sample MSTI Configuration” on page 6-49](#) for more information about how to direct VLAN traffic over separate data paths using MSTP.

Comparing MSTP with STP and RSTP

Using MSTP has the following items in common with STP (802.1D) and RSTP (802.1w) protocols:

- Each protocol ensures one data path between any two switches within the network topology. This prevents network loops from occurring while at the same time allowing for redundant path configuration.
- Each protocol provides automatic reconfiguration of the network Spanning Tree topology in the event of a connection failure and/or when a switch is added to or removed from the network.
- All three protocols are supported in the flat Spanning Tree operating mode.
- The flat mode CST instance automatically determines port states and roles across VLAN port and MSTI associations. This is because the CST instance is active on all ports and only one BPDU is used to forward information for all MSTIs.
- MSTP is based on RSTP.

Using MSTP differs from STP and RSTP as follows:

- MSTP is only supported when the switch is running in the flat Spanning Tree mode. STP and RSTP are supported in both the per-VLAN and flat modes.
- MSTP allows for the configuration of up to 16 Multiple Spanning Tree Instances (MSTI) in addition to the CST instance. Flat mode STP and RSTP protocols only use the single CST instance for the entire switch. See [“What is a Multiple Spanning Tree Instance \(MSTI\)” on page 6-16](#) for more information.
- MSTP applies a single Spanning Tree instance to an MSTI ID number that represents a set of VLANs; a one to many association. STP and RSTP in the flat mode apply one Spanning Tree instance to all VLANs; a one to all association. STP and RSTP in the per-VLAN mode apply a single Spanning Tree instance to each existing VLAN; a one to one association.
- The port priority and path cost parameters are configurable for an individual MSTI that represents the VLAN associated with the port.
- The flat mode 802.1D or 802.1w CST is identified as instance 1. When using MSTP, the CST is identified as CIST (Common and Internal Spanning Tree) instance 0. See [“What is the Common and Internal Spanning Tree Instance” on page 6-18](#) for more information.
- MSTP allows the segmentation of switches within the network into MST regions. Each region is seen as a single virtual bridge to the rest of the network, even though multiple switches can belong to the one region. See [“What is a Multiple Spanning Tree Region” on page 6-17](#) for more information.
- MSTP has lower overhead than a per-VLAN configuration. In per-VLAN mode, because each VLAN is assigned a separate Spanning Tree instance, BPDUs are forwarded on the network for each VLAN. MSTP only forwards one BPDU for the CST that contains information for all configured MSTI on the switch.

What is a Multiple Spanning Tree Instance (MSTI)

An MSTI is a single Spanning Tree instance that represents a group of VLANs. Alcatel-Lucent switches support up to 16 MSTIs on one switch. This number is in addition to the Common and Internal Spanning Tree (CIST) instance 0, which is also known as MSTI 0. The CIST instance exists on every switch. By default, all VLANs not mapped to an MSTI are associated with the CIST instance. See [“What is the Common and Internal Spanning Tree Instance” on page 6-18](#) for more information.

What is a Multiple Spanning Tree Region

A Multiple Spanning Tree region represents a group of MSTP switches. An MST region appears as a single, flat mode instance to switches outside the region. A switch can belong to only one region at a time. The region a switch belongs to is identified by the following configurable attributes, as defined by MSTP.

- **Region name** – An alphanumeric string up to 32 characters.
- **Region revision level** – A numerical value between 0 and 65535.
- **VLAN to MSTI table** – Generated when VLANs are associated with MSTIs. Identifies the VLAN to MSTI mapping for the switch.

Switches that share the same values for the configuration attributes described above belong to the same region. For example, in the diagram below:

- Switches A, B, and C all belong to the same region because they all are configured with the same region name, revision level, and have the same VLANs mapped to the same MSTI.
- The CST for the entire network sees Switches A, B, and C as one virtual bridge that is running a single Spanning Tree instance. As a result, CST blocks the path between Switch C and Switch E instead of blocking a path between the MST region switches to avoid a network loop.
- The paths between Switch A and Switch C and the redundant path between Switch B and Switch C were blocked as a result of the Internal Spanning Tree (IST) computations for the MST Region. See [“What is the Internal Spanning Tree \(IST\) Instance” on page 6-18](#) for more information.

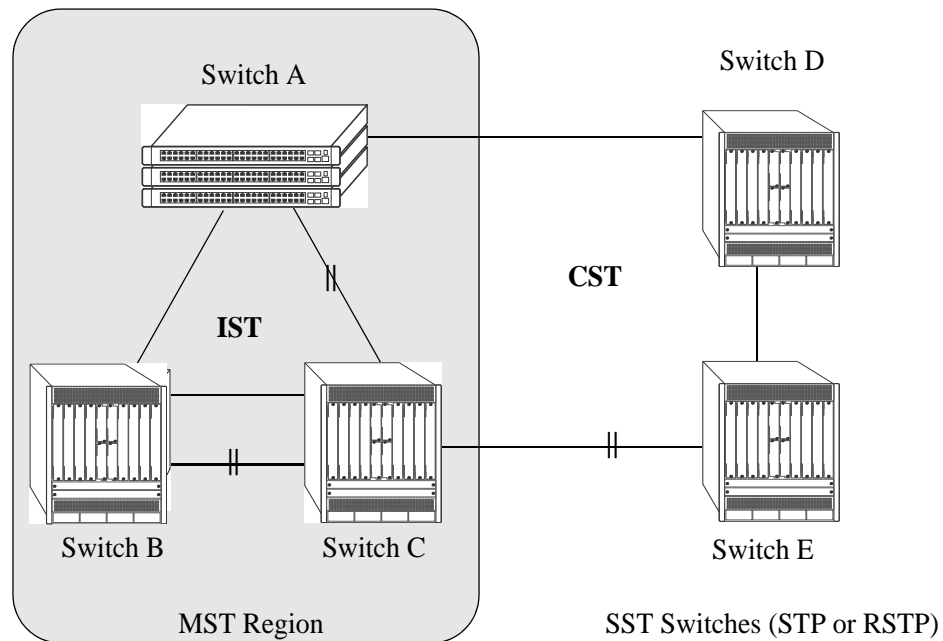

In addition to the attributes described above, the MST maximum hops parameter defines the number of bridges authorized to propagate MST BPDU information. In essence, this value defines the size of the region in that once the maximum number of hops is reached, the BPDU is discarded.

The maximum number of hops for the region is not one of the attributes that defines membership in the region. See [“Sample MST Region Configuration” on page 6-47](#) for a tutorial on how to configure MST region parameters.

What is the Common Spanning Tree

The Common Spanning Tree (CST) is the overall network Spanning Tree topology resulting from STP, RSTP, and/or MSTP calculations to provide a single data path through the network. CST provides connectivity between MST regions and other MST regions and/or Single Spanning Tree (SST) switches. For example, in the above diagram, CST calculations detected a network loop created by the connections between Switch D, Switch E, and the MST Region. As a result, one of the paths was blocked.

What is the Internal Spanning Tree (IST) Instance

The IST instance determines and maintains the CST topology between MST switches that belong to the same MST region. In other words, the IST is simply a CST that only applies to MST Region switches while at the same time representing the region as a single Spanning Tree bridge to the network CST.

As shown in the above diagram, the redundant path between Switch B and Switch C is blocked and the path between Switch A and Switch C is blocked. These blocking decisions were based on IST computations within the MST region. IST sends and receives BPDU to/from the network CST. MSTI within the region do not communicate with the network CST. As a result, the CST only sees the IST BPDU and treats the MST region as a single Spanning Tree bridge.

What is the Common and Internal Spanning Tree Instance

The Common and Internal Spanning Tree (CIST) instance is the Spanning Tree calculated by the MST region IST and the network CST. The CIST is represented by the single Spanning Tree flat mode instance that is available on all switches. By default, all VLANs are associated with the CIST until they are mapped to an MSTI.

When using STP (802.1D) or RSTP (802.1w). When using MSTP, the CIST is also known as instance 0 or MSTI 0.

Note. When MSTP is the active flat mode protocol, explicit Spanning Tree bridge commands are required to configure parameter values. Implicit commands are for configuring parameters when the STP or RSTP protocols are in use. See [“Using Spanning Tree Configuration Commands” on page 6-26](#) for more information.

MST Configuration Overview

The following general steps are required to set up a Multiple Spanning Tree (MST) configuration:

- **Select the flat Spanning Tree mode** – Each switch runs in the default mode. MSTP is only supported on a flat mode switch. See [“Spanning Tree Operating Modes” on page 6-21](#) for more information.
- **Select the MSTP protocol** – Each switch uses the default protocol. Selecting MSTP activates the Multiple Spanning Tree. See [“How MSTP Works” on page 6-13](#) for more information.
- **Configure an MST region name and revision level** – Switches that share the same MST region name, revision level, and VLAN to Multiple Spanning Tree Instance (MSTI) mapping belong to the same MST region. See [“What is a Multiple Spanning Tree Region” on page 6-17](#) for more information.
- **Configure MSTIs** – Every switch has a default Common and Internal Spanning Tree (CIST) instance 0, which is also referred to as MSTI 0. Configuration of additional MSTI is required to segment switch VLANs into separate instances. See [“What is a Multiple Spanning Tree Instance \(MSTI\)” on page 6-16](#) for more information.

- **Map VLANs to MSTI** – All existing VLANs are mapped to the default CIST instance 0. Associating a VLAN to an MSTI specifies which Spanning Tree instance determines the best data path for traffic carried on the VLAN. In addition, the VLAN-to-MSTI mapping is also one of three MST configuration attributes used to determine that the switch belongs to a particular MST region.

For a tutorial on setting up an example MST configuration, see [“Sample MST Region Configuration” on page 6-47](#) and [“Sample MSTI Configuration” on page 6-49](#).

MST Interoperability and Migration

Connecting an MSTP switch to a non-MSTP flat mode switch is supported. Since the Common and Internal Spanning Tree (CIST) controls the flat mode instance on both switches, STP or RSTP can remain active on the non-MSTP switch within the network topology.

An MSTP switch is part of a Multiple Spanning Tree (MST) Region, which appears as a single, flat mode instance to the non-MSTP switch. The port that connects the MSTP switch to the non-MSTP switch is referred to as a *boundary* port. When a boundary port detects an STP (802.1D) or RSTP (802.1w) BPDU, it responds with the appropriate protocol BPDU to provide interoperability between the two switches. This interoperability also serves to indicate the edge of the MST region.

Interoperability between MSTP switches and per-VLAN mode switches is not recommended. The per-VLAN mode is a proprietary implementation that creates a separate Spanning Tree instance for each VLAN configured on the switch. The MSTP implementation is in compliance with the IEEE standard and is only supported on flat mode switches.

Tagged BPDUs transmitted from a per-VLAN switch are ignored by a flat mode switch. This can cause a network loop to go undetected. Although it is not recommended, you can also connect a per-VLAN switch to a flat mode switch temporarily until migration to MSTP is complete. When a per-VLAN switch is connected to a flat mode switch, configure only a fixed, untagged connection between VLAN 1 on both switches.

Migrating from Flat Mode STP/RSTP to Flat Mode MSTP

Migrating an STP/RSTP flat mode switch to MSTP is relatively transparent. When STP or RSTP is the active protocol, the Common and Internal Spanning Tree (CIST) controls the flat mode instance. If on the same switch the protocol is changed to MSTP, the CIST still controls the flat mode instance.

Note the following when converting a flat mode STP/RSTP switch to MSTP:

- Making a backup copy of the switch **vcboot.cfg** file before changing the protocol to MSTP is highly recommended. Having a backup copy makes it easier to revert to the non-MSTP configuration if necessary. Once MSTP is active, commands are written in their explicit form and not compatible with previous releases of Spanning Tree.
- When converting multiple switches, change the protocol to MSTP first on every switch before starting to configure Multiple Spanning Tree Instances (MSTI).
- Once the protocol is changed, MSTP features are available for configuration. Multiple Spanning Tree Instances (MSTI) are now configurable for defining data paths for VLAN traffic. See [“How MSTP Works” on page 6-13](#) for more information.
- Using explicit Spanning Tree commands to define the MSTP configuration is required. Implicit commands are for configuring STP and RSTP. See [“Using Spanning Tree Configuration Commands” on page 6-26](#) for more information.

- STP and RSTP use a 16-bit port path cost (PPC) and MSTP uses a 32-bit PPC. When the protocol is changed to MSTP, the bridge priority and PPC values for the flat mode CIST instance are reset to their default values.
- It is possible to configure the switch to use 32-bit PPC value for all protocols (see the [spantree path-cost-mode](#) command page for more information). If this is the case, then the PPC for the CIST is not reset when the protocol is changed to/from MSTP.
- This implementation of MSTP is compliant with the IEEE 802.1Q 2005 standard and thus provides interconnectivity with MSTP compliant systems.

Migrating from Per-VLAN Mode to Flat Mode MSTP

As previously described, the per-VLAN mode is an Alcatel-Lucent proprietary implementation that applies one Spanning Tree instance to each VLAN. For example, if five VLANs exist on the switch, then there are five Spanning Tree instances active on the switch, unless Spanning Tree is disabled on one of the VLANs.

Note the following when converting a per-VLAN mode STP/RSTP switch to flat mode MSTP:

- Making a backup copy of the switch **vcboot.cfg** file before changing the protocol to MSTP is highly recommended. Having a backup copy makes it easier to revert to the non-MSTP configuration if necessary. Once MSTP is active, commands are written in their explicit form and not compatible with previous releases of Spanning Tree.
- Using MSTP requires changing the switch mode from per-VLAN to flat. When the mode is changed from per-VLAN to flat, ports still retain their VLAN associations but are now part of a single, flat mode Spanning Tree instance that spans across all VLANs. As a result, a path that was forwarding traffic in the per-VLAN mode transitions to a blocking state after the mode is changed to flat.
- Once the protocol is changed, MSTP features are available for configuration. Multiple Spanning Tree Instances (MSTI) are now configurable for defining data paths for VLAN traffic. See [“How MSTP Works” on page 6-13](#) for more information.
- Note that STP/RSTP use a 16-bit port path cost (PPC) and MSTP uses a 32-bit PPC. When the protocol is changed to MSTP, the bridge priority and PPC values for the flat mode CIST instance are reset to their default values.
- It is possible to configure the switch to use 32-bit PPC value for all protocols (see the [spantree path-cost-mode](#) command page for more information). If this is the case, then the PPC for the CIST is not reset when the protocol is changed to/from MSTP.
- This implementation of MSTP is compliant with the IEEE 802.1Q 2005 standard and thus provides interconnectivity with MSTP compliant systems.

Spanning Tree Operating Modes

The switch can operate in one of two Spanning Tree modes: *flat* and *per-VLAN*. Both modes apply to the entire switch and determine whether a single Spanning Tree instance is applied across multiple VLANs (flat mode) or a single instance is applied to each VLAN (per-VLAN mode). A switch runs on the default mode when it is first turned on.

Use the **spantree mode** command to select the Flat or Per-VLAN Spanning Tree mode. The switch operates in one mode or the other, however, it is not necessary to reboot the switch when changing modes.

Using Flat Spanning Tree Mode

Before selecting the flat Spanning Tree mode, consider the following:

- If STP (802.1D) is the active protocol, then there is one Spanning Tree instance for the entire switch; port states are determined across VLANs. If MSTP (802.1s) is the active protocol, then multiple instances up to a total of 17 are allowed. Port states, however, are still determined across VLANs.
- Multiple connections between switches are considered redundant paths even if they are associated with different VLANs.
- Spanning Tree parameters are configured for the single flat mode instance. For example, if Spanning Tree is disabled on VLAN 1, then it is disabled for all VLANs. Disabling STP on any other VLAN, however, only exclude ports associated with that VLAN from the Spanning Tree Algorithm.
- Fixed (untagged) and 802.1Q tagged ports are supported in each VLAN. BPDU, however, are always untagged.
- When the Spanning Tree mode is changed from per-VLAN to flat, ports still retain their VLAN associations but are now part of a single Spanning Tree instance that spans across all VLANs. As a result, a path that was forwarding traffic in the per-VLAN mode can transition to a blocking state after the mode is changed to flat.

To change the Spanning Tree operating mode to flat, enter the following command:

```
-> spantree mode flat
```

The following diagram shows a flat mode switch with STP (802.1D) as the active protocol. All ports, regardless of their default VLAN configuration or tagged VLAN assignments, are considered part of one Spanning Tree instance. To see an example of a flat mode switch with MSTP (802.1s) as the active protocol, see [Chapter 6, “Configuring Spanning Tree Parameters.”](#)

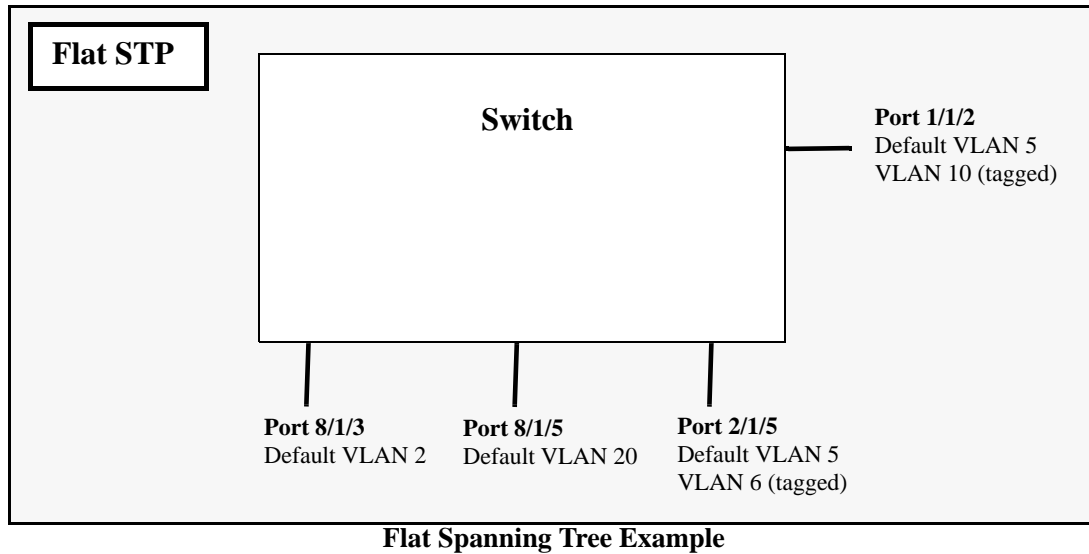

In the above example, if port 8/1/3 connects to another switch and port 8/1/5 connects to that same switch, the Spanning Tree Algorithm would detect a redundant path and transition one of the ports into a blocking state. The same holds true for the tagged ports.

Using Per-VLAN Spanning Tree Mode

Before selecting the Per-VLAN Spanning Tree operating mode, consider the following:

- A single Spanning Tree instance is enabled for each VLAN configured on the switch. For example, if there are five VLANs configured on the switch, then there are five separate Spanning Tree instances, each with its own root VLAN. In essence, a VLAN is a virtual bridge. The VLAN has its own bridge ID and configurable STP parameters, such as protocol, priority, hello time, max age, and forward delay.
- Port state is determined on a per VLAN basis. For example, port connections in VLAN 10 are only examined for redundancy within VLAN 10 across all switches. If a port in VLAN 10 and a port in VLAN 20 both connect to the same switch within their respective VLANs, they are not considered redundant data paths and STP does not block them. However, if two ports within VLAN 10 both connect to the same switch, then the STP transition one of these ports to a blocking state.
- Fixed (untagged) ports participate in the single Spanning Tree instance that applies to their configured default VLAN.
- 802.1Q tagged ports participate in an 802.1Q Spanning Tree instance that allows the Spanning Tree to extend across tagged VLANs. As a result, a tagged port can participate in more than one Spanning Tree instance; one for each VLAN that the port carries.
- If a VLAN contains both fixed and tagged ports, then a hybrid of the two Spanning Tree instances (single and 802.1Q) is applied. If a VLAN appears as a tag on a port, then the BPDU for that VLAN are also tagged. However, if a VLAN appears as the configured default VLAN for the port, then BPDU are not tagged and the single Spanning Tree instance applies.

To change the Spanning Tree operating mode to per-VLAN, enter the following command:

```
-> spantree mode per-vlan
```

The following diagram shows a switch running in the per-VLAN Spanning Tree mode and shows Spanning Tree participation for both fixed and tagged ports.

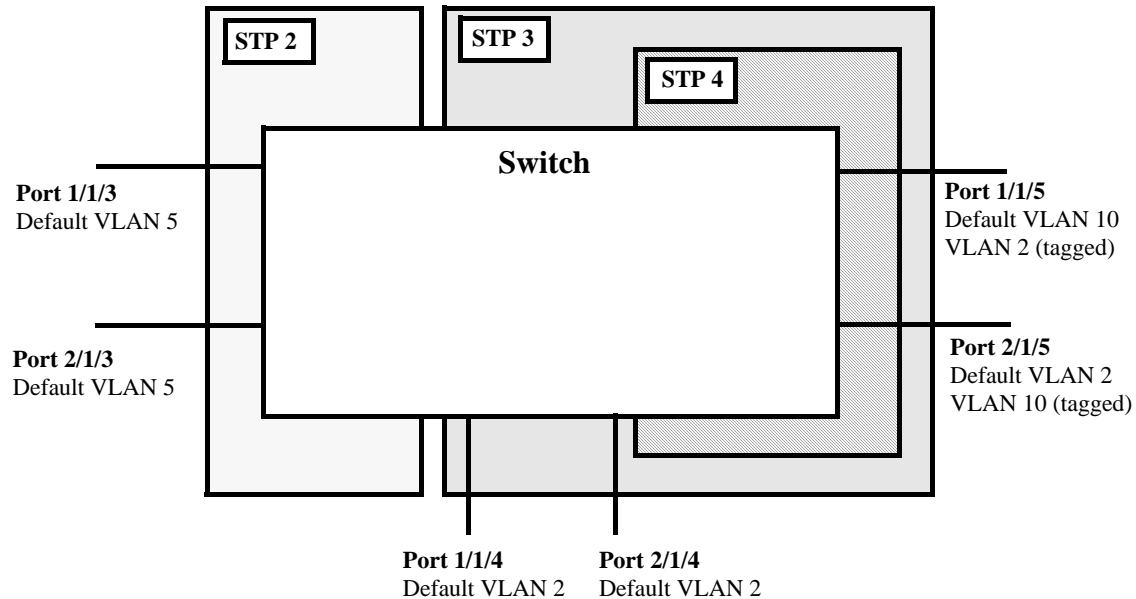

Per VLAN (single and 802.1Q) Spanning Tree Example

In the above example, STP2 is a single Spanning Tree instance since VLAN 5 contains only fixed ports. STP 3 and STP 4 are a combination of single and 802.1Q Spanning Tree instances because VLAN 2 contains both fixed and tagged ports. On ports where VLAN 2 is the default VLAN, BPDU are not tagged. on ports where VLAN 2 is a tagged VLAN, BPDU are also tagged.

Using Per-VLAN Spanning Tree Mode with PVST+

In order to interoperate with Cisco's proprietary Per Vlan Spanning Tree (PVST+) mode, the current Alcatel-Lucent per-VLAN Spanning Tree mode allows OmniSwitch ports to transmit and receive either the standard IEEE BPDUs or Cisco's proprietary PVST+ BPDUs. When the PVST+ mode is enabled, a user port operates in the default mode initially until it detects a PVST+ BPDU, which automatically enables the port to operate in the Cisco PVST+ compatible mode.

The PVST+ compatibility mode allows OmniSwitch ports to operate in the per-VLAN mode when connected to another OmniSwitch or in the Cisco PVST+ mode when connected to a Cisco switch. As a result, both the Alcatel-Lucent per-VLAN and Cisco PVST+ modes can co-exist on the same OmniSwitch *and* interoperate correctly with a Cisco switch using the standard Spanning Tree protocols (STP or RSTP).

Note. In the flat Spanning Tree mode, both the OmniSwitch and Cisco switches can interoperate seamlessly using the standard MSTP protocol.

OmniSwitch PVST+ Interoperability

Native VLAN and OmniSwitch Default VLAN

Cisco uses the standard IEEE BPDU format for the native VLAN (VLAN 1) over an 802.1Q trunk. Thus, by default the Common Spanning Tree (CST) instance of the native VLAN 1 for all Cisco switches and the STP instance for the default VLAN of a port on an OmniSwitch interoperates and successfully creates a loop-free topology.

802.1Q Tagged VLANs

For 802.1Q tagged VLANs, Cisco uses a proprietary frame format which differs from the standard IEEE BPDU format used by Alcatel-Lucent *per-VLAN* mode, thus preventing Spanning Tree topologies for tagged VLANs from interoperating over the 802.1Q trunk.

In order to interoperate with Cisco PVST+ mode, the current Alcatel-Lucent *per-VLAN* mode has an option to recognize Cisco's proprietary PVST+ BPDUs. This allows any user port on an OmniSwitch to send and receive PVST+ BPDUs, so that loop-free topologies for the tagged VLANs can be created between OmniSwitch and Cisco switches.

Configuration Overview

The `spantree pvst+compatibility` command is used to enable or disable the PVST+ interoperability mode globally for all switch ports and link aggregates or on a per-port/link aggregate basis. By default, PVST+ compatibility is disabled.

To globally enable or disable PVST+ interoperability, enter the following commands:

```
-> spantree pvst+compatibility enable
-> spantree pvst+compatibility disable
```

To enable or disable PVST+ interoperability for a specific port or link aggregate, use the `spantree pvst+compatibility` command with the `port` or `linkagg` parameter. For example:

```
-> spantree pvst+compatibility port 1/1/3 enable
-> spantree pvst+compatibility port 2/1/24 disable
-> spantree pvst+compatibility linkagg 3 enable
-> spantree pvst+compatibility linkagg 10 disable
```

The following causes a port to exit from the enabled state:

- The link status of the port changes.
- The administrative status of the port changes.
- The PVST+ status of the port is disabled or set to auto.

To configure a port or link aggregate to automatically detect

The `spantree pvst+compatibility` command also provides an `auto` option to configure the port to handle IEEE BPDUs initially (i.e., disable state). Once a PVST+ BPDU is received, it handles the PVST+ BPDUs and IEEE BPDUs for a Cisco native VLAN. For example:

```
-> spantree pvst+compatibility port 1/1/3 auto
-> spantree pvst+compatibility linkagg 3 auto
```

The following **show** command displays the PVST+ status.

```
-> show spantree mode

Spanning Tree Global Parameters
Current Running Mode   : per-vlan,
Current Protocol      : N/A (Per VLAN),
Path Cost Mode        : 32 BIT,
Auto Vlan Containment : N/A
Cisco PVST+ mode      : Enabled
Vlan Consistency check: Disabled
```

BPDU Processing in PVST+ Mode

An OmniSwitch port operating in PVST+ mode processes BPDUs as follows:

If the default VLAN of a port is VLAN 1 then:

- Send and receive IEEE untagged BPDUs for VLAN 1
- Don't send and receive PVST+ tagged BPDUs for VLAN 1
- Send and receive tagged PVST+ BPDUs for other tagged VLANs.

If the default VLAN of a port is not VLAN 1 then:

- Send and receive IEEE untagged BPDUs for VLAN 1
- Don't send and receive PVST+ tagged BPDUs for VLAN 1
- Send and receive untagged PVST+ BPDUs for the port's default VLAN
- Send and receive tagged PVST+ BPDUs for other tagged VLANs

Recommendations and Requirements for PVST+ Configurations

- It is mandatory that all the Cisco switches have the MAC Reduction Mode feature enabled in order to interoperate with an OmniSwitch in PVST+ mode. This avoids any unexpected election of a root bridge.
- You can assign the priority value only in the multiples of 4096 to be compatible with the Cisco MAC Reduction mode; any other values result in an error message. Also, the existing per vlan priority values are restored when changing from PVST+ mode back to per-VLAN mode. For more information on priority, refer [“Configuring the Bridge Priority” on page 6-28](#).
- In a mixed OmniSwitch and Cisco environment, it is highly recommended to enable PVST+ mode on all OmniSwitches in order to maintain the same root bridge for the topology. It is possible that the new root bridge might be elected as a result of inconsistencies of MAC reduction mode when connecting an OmniSwitch that does not support Cisco PVST+ mode to an OmniSwitch with the PVST+ mode enabled. In this case, the root bridge priority must be changed manually to maintain the same root bridge. For more information on priority, refer [“Configuring the Bridge Priority” on page 6-28](#).
- A Cisco switch running in PVST mode (another Cisco proprietary mode prior to 802.1q standard) is not compatible with an OmniSwitch running in per-VLAN PVST+ mode.
- Both Cisco and OmniSwitch support two default path cost modes; long or short. It is recommended that the same default path cost mode be configured in the same way on all switches so that the path costs for similar interface types are consistent when connecting ports between OmniSwitch and Cisco

Switches. For more information on path cost mode, refer [“Configuring the Path Cost Mode” on page 6-32](#).

- Dynamic aggregate link (LACP) functions properly between OmniSwitch and Cisco switches. The Cisco switches send the BPDUs only on one physical link of the aggregate, similar to the OmniSwitch Primary port functionality. The path cost assigned to the aggregate link is not the same between OmniSwitch and Cisco switches since vendor-specific formulas are used to derive the path cost. Manual configuration is recommended to match the Cisco path cost assignment for an aggregate link. For more information on the configuration of path cost for aggregate links, refer [“Path Cost for Link Aggregate Ports” on page 6-38](#).

The table below shows the default Spanning Tree values.

Parameters	OmniSwitch	Cisco
Mac Reduction Mode	Enabled	Disabled
Bridge Priority	32768	32768
Port Priority	128	32 (catOS) / 128 (IOS)
Port Path Cost	IEEE Port Speed Table	IEEE Port Speed Table
Aggregate Path Cost	Proprietary Table	Avg Path Cost / NumPorts
Default Path Cost Mode	Short (16-bit)	Short (16-bit)
Max Age	20	20
Hello Time	2	2
Forward Delay Time	15	15
Default Protocol	RSTP (1w) Per Vlan	PVST+ (1d) Per Switch

Using Spanning Tree Configuration Commands

The Alcatel-Lucent Spanning Tree implementation uses commands that contain one of the following keywords to specify the type of Spanning Tree instance to modify:

- **cist** – command applies to the Common and Internal Spanning Tree instance. The CIST is the single Spanning Tree flat mode instance that is available on all switches. When using STP or RSTP, the CIST is also known as instance 1 or bridge 1.
- **msti** – command applies to the specified Multiple Spanning Tree Instance. When using MSTP (802.1s), the CIST instance is also known as MSTI 0.
- **vlan** – command applies to the specified VLAN instance.

These commands (referred to as explicit commands) allow the configuration of a particular Spanning Tree instance independent of which mode and/or protocol is currently active on the switch. The configuration, however, does not go active until the switch is changed to the appropriate mode. For example, if the switch is running in the per-VLAN mode, the following explicit command changes the MSTI 3 priority to 12288:

```
-> spantree msti 3 priority 12288
```

Even though the above command is accepted in the per-VLAN mode, the new priority value does not take effect until the switch mode is changed to flat mode.

Note. When a snapshot is taken of the switch configuration, the explicit form of all Spanning Tree commands is captured. For example, if the priority of MSTI 2 was changed from the default value to a priority of 16384, then **spantree msti 2 priority 16384** is the command captured to reflect this in the snapshot file. In addition, explicit commands are captured for both flat and per-VLAN mode configurations.

Configuring STP Bridge Parameters

The Spanning Tree software is active on all switches by default and uses default bridge and port parameter values to calculate a loop free topology. It is only necessary to configure these parameter values if it is necessary to change how the topology is calculated and maintained.

Note the following when configuring Spanning Tree bridge parameters:

- When a switch is running in the per-VLAN Spanning Tree mode, each VLAN is in essence a virtual bridge with its own Spanning Tree instance and configurable bridge parameters.
- When the switch is running in the flat mode and STP (802.1D) or RSTP (802.1w) is the active protocol, bridge parameter values are only configured for the flat mode instance.
- If MSTP (802.1s) is the active protocol, then the priority value is configurable for each Multiple Spanning Tree Instance (MSTI). All other parameters, however, are still only configured for the flat mode instance and are applied across all MSTIs.
- Bridge parameter values for a VLAN instance are not active unless Spanning Tree is enabled on the VLAN and at least one active port is assigned to the VLAN. Use the **spantree vlan admin-state** command to enable or disable a VLAN Spanning Tree instance.
- If Spanning Tree is disabled on a VLAN, active ports associated with that VLAN are excluded from Spanning Tree calculations and remain in a forwarding state.
- Note that when a switch is running in the flat mode, disabling Spanning Tree on VLAN 1 disables the instance for all VLANs and all active ports are then excluded from any Spanning Tree calculations and remain in a forwarding state.

The following is a summary of Spanning Tree bridge configuration commands. For more information about these commands, see the *OmniSwitch AOS Release 8 CLI Reference Guide*.

Commands	Used for ...
spantree protocol	Configuring the protocol for the flat mode CIST instance or a per-VLAN mode VLAN instance.
spantree priority	Configuring the priority value for the flat mode CIST instance, a Multiple Spanning Tree Instance (MSTI), or a per-VLAN mode VLAN instance.
spantree hello-time	Configuring the hello time value for the flat mode CIST instance or a per-VLAN mode VLAN instance.
spantree max-age	Configuring the maximum age time value for the flat mode CIST instance or a per-VLAN mode VLAN instance.

Commands	Used for ...
spantree forward-delay	Configuring the forward delay time value for the flat mode CIST instance or a per-VLAN mode VLAN instance.
spantree bpdu-switching	Configuring the BPDU switching status for a VLAN.
spantree path-cost-mode	Configuring the automatic selection of a 16-bit path cost for STP/RSTP ports and a 32-bit path cost for MSTP ports or sets all path costs to use a 32-bit value.
spantree auto-vlan-containment	Enables or disables Auto VLAN Containment (AVC) for 802.1s instances.
spantree pvst+compatibility	Enables or disables PVST+ mode on the switch.

The following sections provide information and procedures for using the bridge configuration commands and also includes command examples.

Selecting the Spantree Protocol

The switch supports three Spanning Tree protocols: STP, RSTP (the default), MSTP. To configure the Spanning Tree protocol for a VLAN instance regardless of which mode (per-VLAN or flat) is active for the switch, use the [spantree protocol](#) command with the **vlan** parameter. For example, the following command changes the protocol to RSTP for VLAN 455:

```
-> spantree vlan 455 protocol rstp
```

Note. When configuring the protocol value for a VLAN instance, MSTP is not an available option. This protocol is only supported on the flat mode instance.

To configure the protocol for the flat mode CIST instance, use either the [spantree protocol](#) command or the [spantree protocol](#) command with the **cist** parameter. Note that both commands are available when the switch is running in either mode (per-VLAN or flat). For example, the following commands configure the protocol for the flat mode instance to MSTP:

```
-> spantree cist protocol mstp
-> spantree protocol mstp
```

Configuring the Bridge Priority

A bridge is identified within the Spanning Tree by its bridge ID (an eight byte hex number). The first two bytes of the bridge ID contain a priority value and the remaining six bytes contain a bridge MAC address.

The bridge priority is used to determine which bridge serves as the root of the Spanning Tree. The lower the priority value, the higher the priority. If more than one bridge have the same priority, then the bridge with the lowest MAC address becomes the root.

Note. Configuring a Spanning Tree bridge instance with a priority value that causes the instance to become the root is recommended, instead of relying on the comparison of switch base MAC addresses to determine the root.

If the switch is running in the per-VLAN Spanning Tree mode, then a priority value is assigned to each VLAN instance. If the switch is running in the flat Spanning Tree mode, the priority is assigned to the flat

mode instance or a Multiple Spanning Tree Instance (MSTI). In both cases, the default priority value is assigned. Note that priority value for an MSTI must be a multiple of 4096.

To change the bridge priority value for a VLAN instance regardless of which mode (per-VLAN or flat) is active for the switch, use the **spantree priority** command with the **vlan** parameter. For example, the following command changes the priority for VLAN 455 to 25590:

```
-> spantree vlan 455 priority 25590
```

Note. If PVST+ mode is enabled on the switch, then the priority values can be assigned only in the multiples of 4096 to be compatible with the Cisco MAC Reduction mode; any other values result in an error message.

To change the bridge priority value for the flat mode CIST instance, use either the **spantree priority** command or the **spantree priority** command with the **cist** parameter. Note that both commands are available when the switch is running in either mode (per-VLAN or flat). For example, the following commands change the bridge priority value for the flat mode instance to 12288:

```
-> spantree cist priority 12288
-> spantree priority 12288
```

The bridge priority value is also configurable for a Multiple Spanning Tree Instance (MSTI). To configure this value for an MSTI, use the **spantree priority** command with the **msti** parameter and specify a priority value that is a multiple of 4096. For example, the following command configures the priority value for MSTI 10 to 61440:

```
-> spantree msti 10 priority 61440
```

Configuring the Bridge Hello Time

The bridge hello time interval is the number of seconds a bridge waits between transmissions of Configuration BPDU. When a bridge is attempting to become the root or if it has become the root or a designated bridge, it sends Configuration BPDU out all forwarding ports once every hello time value.

The hello time propagated in a root bridge Configuration BPDU is the value used by all other bridges in the tree for their own hello time. Therefore, if this value is changed for the root bridge, all other bridges associated with the same STP instance adopt this value as well.

Note. Lowering the hello time interval improves the robustness of the Spanning Tree algorithm. Increasing the hello time interval lowers the overhead of Spanning Tree processing.

If the switch is running in the per-VLAN Spanning Tree mode, then a hello time value is defined for each VLAN instance. If the switch is running in the flat Spanning Tree mode, then a hello time value is defined for the single flat mode instance. In both cases, the default hello time value is used.

To change the bridge hello time value for a VLAN instance regardless of which mode (per-VLAN or flat) is active for the switch, use the **spantree hello-time** command with the **vlan** parameter. For example, the following command changes the hello time for VLAN 455 to 5 seconds:

```
-> spantree vlan 455 hello-time 5
```

To change the bridge hello time value for the flat mode CIST instance, use either the **spantree hello-time** command or the **spantree hello-time** command with the **cist** parameter. Note that both commands are available when the switch is running in either mode (per-VLAN or flat). For example, the following commands change the hello time value for the flat mode instance to 10:

```
-> spantree hello-time 10
-> spantree cist hello-time 10
```

Note that the bridge hello time is not configurable for Multiple Spanning Tree Instances (MSTI). These instances inherit the hello time from the flat mode instance (CIST).

Configuring the Bridge Max-Age Time

The bridge max-age time specifies how long, in seconds, the bridge retains Spanning Tree information it receives from Configuration BPDU. When a bridge receives a BPDU, it updates its configuration information and the max age timer is reset. If the max age timer expires before the next BPDU is received, the bridge attempts to become the root, designated bridge, or change its root port.

The max-age time propagated in a root bridge Configuration BPDU is the value used by all other bridges in the tree for their own max-age time. Therefore, if this value is changed for the root bridge, all other VLANs associated with the same instance adopt this value as well.

If the switch is running in the per-VLAN Spanning Tree mode, then a max-age time value is defined for each VLAN instance. If the switch is running in the flat Spanning Tree mode, then the max-age value is defined for the flat mode instance. In both cases, the default max-age time is used.

Note. Configuring a low max-age time can cause the Spanning Tree to reconfigure the topology more often.

To change the bridge max-age time value for a VLAN instance regardless of which mode (per-VLAN or flat) is active for the switch, use the **spantree max-age** command with the **vlan** parameter. For example, the following command changes the max-age time for VLAN 455 to 10 seconds:

```
-> spantree vlan 455 max-age 10
```

To change the max-age time value for the flat mode CIST instance, use either the **spantree max-age** command or the **spantree max-age** command with the **cist** parameter. Note that both commands are available when the switch is running in either mode (per-VLAN or flat). For example, the following commands change the max-age time value for the flat mode instance to 10:

```
-> spantree max-age 10
-> spantree cist max-age 10
```

Note. The max-age time is not configurable for Multiple Spanning Tree Instances (MSTI). These instances inherit the max-age time from the flat mode instance (CIST).

Configuring the Forward Delay Time for the Switch

The bridge forward delay time specifies how long, in seconds, a port remains in the learning state while it is transitioning to a forwarding state. In addition, when a topology change occurs, the forward delay time value is used to age out all dynamically learned addresses in the MAC address forwarding table. For more information about the MAC address table, see [Chapter 3, “Managing Source Learning.”](#)

The forward delay time propagated in a root bridge Configuration BPDU is the value used by all other bridges in the tree for their own forward delay time. Therefore, if this value is changed for the root bridge, all other bridges associated with the same instance adopt this value as well.

If the switch is running in the per-VLAN Spanning Tree mode, then a forward delay time value is defined for each VLAN instance. If the switch is running in the flat Spanning Tree mode, then the forward delay time value is defined for the flat mode instance. In both cases, the default forward delay time is used.

Note. Specifying a low forward delay time can cause temporary network loops, because packets can get forwarded before Spanning Tree configuration or change notices have reached all nodes in the network.

To change the bridge forward delay time value for a VLAN instance regardless of which mode (per-VLAN or flat) is active for the switch, use the **spantree forward-delay** command with the **vlan parameter**. For example, the following command changes the forward delay time for VLAN 455 to 10 seconds:

```
-> spantree vlan 455 forward-delay 10
```

To change the forward-delay time value for the flat mode CIST instance, use either the **spantree forward-delay** command or the **spantree forward-delay** command with the **cist** parameter. Note that both commands are available when the switch is running in either mode (per-VLAN or flat). For example, the following commands change the forward-delay time value for the flat mode instance to 10:

```
-> spantree forward-delay 10
-> spantree cist forward-delay 10
```

Note. The forward delay time is not configurable for Multiple Spanning Tree Instances (MSTI). These instances inherit the forward delay time from the flat mode instance (CIST).

Enabling/Disabling the VLAN BPDU Switching Status

BPDU are not switched on ports associated with VLANs that have Spanning Tree disabled. This can result in a network loop if the VLAN has redundant paths to one or more other switches. Allowing VLANs that have Spanning Tree disabled to forward BPDU to all ports in the VLAN, can help to avoid this problem.

To enable or disable the switching of Spanning Tree BPDU for all VLAN and CIST instances when the switch is running in the per-VLAN mode, use the **spantree bpdu-switching** command:

```
-> spantree bpdu-switching enable
-> spantree bpdu-switching disable
```

To enable or disable the switching of Spanning Tree BPDU for only the CIST instance when the switch is running in the flat mode, use the **spantree bpdu-switching** command:

```
-> spantree cist bpdu-switching enable
-> spantree cist bpdu-switching disable
```

To enable or disable BPDU switching on a VLAN, use the **vlan** parameter along with **spantree bpdu-switching** command. For example, the following commands enable BPDU switching on VLAN 10 and disable it on VLAN 20:

```
-> spantree vlan 10 bpdu-switching enable
-> spantree vlan 20 bpdu-switching disable
```

Note. Disabling BPDU switching on a Spanning Tree disabled VLAN must not cause network loops to go undetected.

Configuring the Path Cost Mode

The path cost mode controls whether the switch uses a 16-bit port path cost (PPC) or a 32-bit PPC. When a 32-bit PPC switch connects to a 16-bit PPC switch, the 32-bit switch has a higher PPC value that advertises an inferior path cost to the 16-bit switch. In this case, it is desirable to set the 32-bit switch to use STP or RSTP with a 16-bit PPC value.

The path cost mode is automatically set to use a 16-bit value for all ports that are associated with an STP instance or an RSTP instance and a 32-bit value for all ports associated with an MSTP value. It is also possible to set the path cost mode to always use a 32-bit regardless of which protocol is active.

To change the path cost mode, use the **spantree path-cost-mode** command and specify either **auto** (uses PPC value based on protocol) or **32bit** (always use a 32-bit PPC value). For example, the following command changes the default path cost mode from auto to 32-bit:

```
-> spantree path-cost-mode 32bit
```

Note. Cisco supports two default path cost modes: long or short, similar to the OmniSwitch per-VLAN implementation. If you have configured PVST+ mode in the OmniSwitch, it is recommended that the same default path cost mode must be configured in the same way in all the switches, so that, the path costs for similar interface types are consistent when connecting ports between OmniSwitch and Cisco Switches.

Using Automatic VLAN Containment

In a Multiple Spanning Tree (MST) configuration, it is possible for a port that belongs to a VLAN that is not a member of an instance to become the root port for that instance. This can cause a topology change that could lead to a loss of connectivity between VLANs/switches. Enabling Automatic VLAN Containment (AVC) helps to prevent this from happening by making such a port an undesirable choice for the root.

When AVC is enabled, it identifies undesirable ports and automatically configures them with an infinite path cost value. For example, in the following diagram a link exists between VLAN 2 on two different switches. The ports that provide this link belong to default VLAN 1 but are tagged with VLAN 2. In addition, VLAN 2 is mapped to MSTI 1 on both switches.

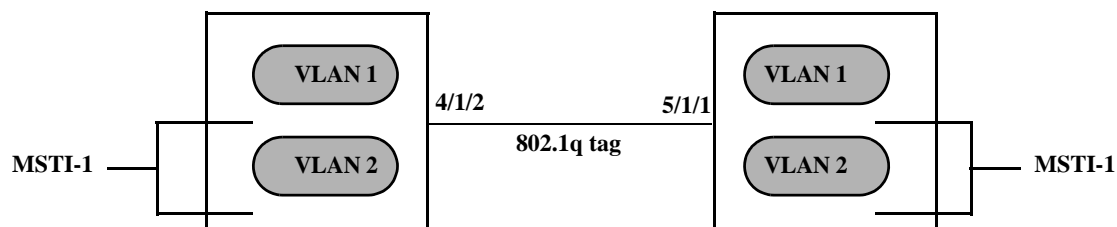

In the above diagram, port 4/1/2 is the Root port and port 5/1/1 is a Designated port for MSTI 1. AVC is not enabled. If another link with the same speed and lower port numbers is added to default VLAN 1 on

both switches, the new link becomes the root for MSTI 1 and the tagged link between VLAN 2 is blocked, as shown below:

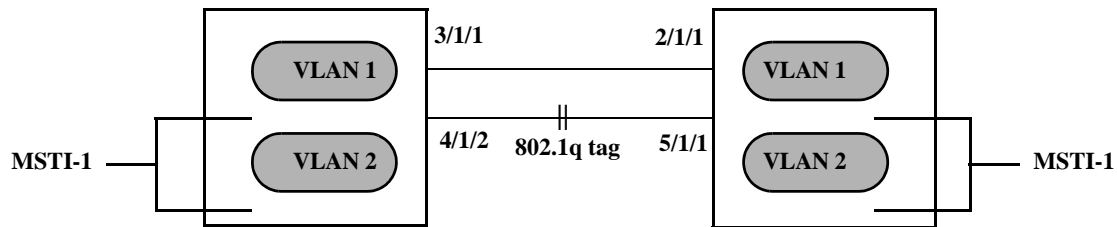

If AVC was enabled in the above example, AVC would have assigned the new link an infinite path cost value that would make this link undesirable as the root for MSTI 1.

Balancing VLANs across links according to their Multiple Spanning Tree Instance (MSTI) grouping is highly recommended to ensure that there is not a loss of connectivity during any possible topology changes. Enabling AVC on the switch is another way to prevent undesirable ports from becoming the root for an MSTI.

To change the default status of the AVC on the switch and to globally enable this feature for all MSTIs, use the **spantree auto-vlan-containment** command. Once AVC is globally enabled, then it is possible to disable AVC for individual MSTIs using the same command. For example, the following commands globally enable AVC and then disable it for MSTI 10:

```
-> spantree auto-vlan-containment enable
-> spantree msti 10 auto-vlan-containment disable
```

Note. An administratively set port path cost takes precedence and prevents AVC configuration of the path cost. The exception to this is if the port path cost is administratively set to zero, which resets the path cost to the default value. In addition, AVC does not have any effect on root bridges.

Configuring STP Port Parameters

The following sections provide information and procedures for using CLI commands to configure STP port parameters. These parameters determine the behavior of a port for a specific Spanning Tree instance.

When a switch is running in the per-VLAN STP mode, each VLAN is in essence a virtual STP bridge with its own STP instance and configurable parameters. To change STP port parameters while running in this mode, a VLAN ID is specified to identify the VLAN STP instance associated with the specified port. When a switch is running in the flat Spanning Tree mode, VLAN 1 is specified for the VLAN ID.

Only bridged ports participate in the Spanning Tree Algorithm. A port is considered bridged if it meets all the following criteria:

- Port is either a fixed (non-mobile) port, an 802.1Q tagged port, or a link aggregate logical port.
- Spanning tree is enabled on the port.
- Port is assigned to a VLAN that has Spanning Tree enabled.
- Port state (forwarding or blocking) is dynamically determined by the Spanning Tree Algorithm, not manually set.

The following is a summary of Spanning Tree port configuration commands. For more information about these commands, see the *OmniSwitch AOS Release 8 CLI Reference Guide*.

Commands	Used for ...
spantree cist	Configuring the port Spanning Tree status for the single flat mode instance.
spantree vlan	Configuring the port Spanning Tree status for a VLAN instance.
spantree priority	Configuring the priority value for the flat mode CIST instance, a Multiple Spanning Tree Instance (MSTI), or a per-VLAN mode VLAN instance.
spantree loop-guard	Enables or disables the STP loop-guard on a port or link aggregate.
spantree cist path-cost	Configuring the port path cost value for the single flat mode instance.
spantree msti path-cost	Configuring the port path cost value for a Multiple Spanning Tree Instance (MSTI).
spantree vlan path-cost	Configuring the port path cost value for a VLAN instance.
spantree cist mode	Configuring the port Spanning Tree mode (dynamic or manual) for the single flat mode instance.
spantree loop-guard	Configuring the port Spanning Tree mode (dynamic or manual) for a VLAN instance.
spantree cist connection	Configuring the port connection type for the single flat mode instance.
spantree vlan connection	Configuring the port connection type for a VLAN instance.
spantree cist admin-edge	Configures the connection type for a port or an aggregate of ports for the flat mode Common and Internal Spanning Tree (CIST).
spantree vlan admin-edge	Configures the connection type for a port or an aggregate of ports for a per-VLAN mode VLAN instance.

Commands	Used for ...
spantree cist auto-edge	Configures a port or an aggregate of ports for the flat mode Common and Internal Spanning Tree (CIST) as an edge port, automatically.
spantree vlan auto-edge	Configures a port or an aggregate of ports for the per-VLAN mode VLAN instance as an edge port, automatically.
spantree cist restricted-role	Configures the restricted role status for a port or an aggregate of ports for the flat mode Common and Internal Spanning Tree (CIST) as a restricted role port.
spantree vlan restricted-role	Configures a port or an aggregate of ports for the per-VLAN mode VLAN instance as a restricted role port.
spantree cist restricted-tcn	Configures a port or an aggregate of ports for the flat mode Common and Internal Spanning Tree (CIST) to support the restricted TCN capability.
spantree vlan restricted-tcn	Configures a port or an aggregate of ports for the per-VLAN mode VLAN instance to support the restricted TCN capability.
spantree cist txholdcount	Limits the transmission of BPDU through a given port for the flat mode Common and Internal Spanning Tree (CIST).
spantree vlan txholdcount	Limits the transmission of BPDU through a given port for the per-VLAN mode VLAN instance.
spantree pvst+compatibility	Configures the type of BPDU to be used on a port when PVST+ mode is enabled.

The following sections provide information and procedures for using Spanning Tree port configuration commands and also includes command examples.

Enabling/Disabling Spanning Tree on a Port

Spanning Tree is automatically enabled on all eligible ports. When Spanning Tree is disabled on a port, the port is put in a forwarding state for the specified instance. For example, if a port is associated with both VLAN 10 and VLAN 20 and Spanning Tree is disabled on the port for VLAN 20, the port state is set to forwarding for VLAN 20. However, the VLAN 10 instance still controls the port state as it relates to VLAN 10. This example assumes the switch is running in the per-VLAN Spanning Tree mode.

If the switch is running in the flat Spanning Tree mode, then disabling the port Spanning Tree status applies across all VLANs associated with the port. The flat mode instance is specified as the instance associated with the port, even if the port is associated with multiple VLANs.

To change the port Spanning Tree status for a VLAN instance regardless of which mode (per-VLAN or flat) is active for the switch, use the **spantree vlan** command. For example, the following commands enable Spanning Tree on port 8/1/1 for VLAN 10 and disable STP on port 6/1/2 for VLAN 20:

```
-> spantree vlan 10 port 8/1/1 enable
-> spantree vlan 20 port 6/1/2 disable
```

To change the port Spanning Tree status for the flat mode instance, use the **spantree cist** command. Note that this command is available when the switch is running in either mode (per-VLAN or flat). For example, the following command disables the Spanning Tree status on port 1/1/24 for the flat mode instance:

```
-> spantree cist port 1/1/24 disable
```

Spanning Tree on Link Aggregate Ports

Physical ports that belong to a link aggregate do not participate in the Spanning Tree Algorithm. Instead, the algorithm is applied to the aggregate logical link (virtual port) that represents a collection of physical ports.

To enable or disable the Spanning Tree status for a link aggregate, use the **spantree vlan** or **spantree cist** commands described above but specify a link aggregate control (ID) number instead of a port. For example, the following command disables Spanning Tree for the link aggregate 10 association with VLAN 755:

```
-> spantree vlan 755 linkagg 10 disable
```

For more information about configuring an aggregate of ports, see [Chapter 9, “Configuring Static Link Aggregation,”](#) and [Chapter 10, “Configuring Dynamic Link Aggregation.”](#)

Enabling/Disabling Loop-guard

By default, loop-guard is disabled on ports associated with VLANs that have Spanning Tree enabled. This feature, when enabled prevents inconsistencies that cause network loops.

Use the **spantree loop-guard** command to enable or disable loop-guard on a port or link aggregate. For example, the following commands enable and disable loop-guard on port 1/2 of chassis 1:

```
-> spantree port 1/1/2 loop-guard enable
-> spantree port 1/1/2 loop-guard disable
```

To enable or disable loop-guard on a link aggregate:

```
-> spantree linkagg 1 loop-guard enable
-> spantree linkagg 1 loop-guard disable
```

Note. Use the **show spantree** and related commands to view the loop-guard related information for per-port, per-VLAN, CIST or MSTI instances.

Configuring Port Priority

A bridge port is identified within the Spanning Tree by its Port ID (a 16-bit or 32-bit hex number). The first 4 bits of the Port ID contain a priority value and the remaining 12 bits contain the physical switch port number. The port priority is used to determine which port offers the best path to the root when multiple paths have the same path cost. The port with the highest priority (lowest numerical priority value) is selected and the others are put into a blocking state. If the priority values are the same for all ports in the path, then the port with the lowest physical switch port number is selected.

Spanning Tree is automatically enabled on a port and the default port priority value is set. If the switch is running in the per-VLAN Spanning Tree mode, then the port priority applies to the specified VLAN instance associated with the port. If the switch is running in the flat Spanning Tree mode, then the port priority applies across all VLANs associated with the port. The flat mode instance is specified as the port instance, even if the port is associated with multiple VLANs.

To change the port priority value for a VLAN regardless of which mode (per-VLAN or flat) is active for the switch, use the **spantree priority** command with the **vlan** and **port** parameters. For example, the following command sets the priority value as 3 for the port 8/1/1 association with VLAN ID 10:

```
-> spantree vlan 10 port 8/1/1 priority 3
```

To change the port priority value for the flat mode instance, use the **spantree priority** command with the **cist** and **port** parameters. Note that this command is available when the switch is running in either per-VLAN or flat mode. An instance number is not required. For example, the following command changes the priority value for port 1/1/24 for the flat mode instance to 15:

```
-> spantree cist port 1/1/24 priority 15
```

The port priority value is also configurable for a Multiple Spanning Tree Instance (MSTI). To configure this value for an MSTI, use the **spantree priority** command with the **msti** and **port** parameters. For example, the following command configures the priority value for port 1/1/12 for MSTI 10 to 5:

```
-> spantree msti 10 port 1/1/12 priority 5
```

Note that configuring the port priority value for a MSTI is allowed in both modes (per-VLAN and flat) only when the Spanning Tree protocol is set to MSTP.

Port Priority on Link Aggregate Ports

Physical ports that belong to a link aggregate do not participate in the Spanning Tree Algorithm. Instead, the algorithm is applied to the aggregate logical link (virtual port) that represents a collection of physical ports.

To change the priority for a link aggregate, use the **spantree priority** command with the **cist**, **msti**, or **vlan** parameters, as described above but specify a link aggregate control number instead of a port number. For example, the following command sets the priority for the link aggregate 10 association with VLAN 755 to 9:

```
-> spantree vlan 755 linkagg 10 priority 9
```

For more information about configuring an aggregate of ports, see [Chapter 9, “Configuring Static Link Aggregation,”](#) and [Chapter 10, “Configuring Dynamic Link Aggregation.”](#)

Configuring Port Path Cost

The path cost value specifies the contribution of a port to the path cost towards the root bridge that includes the port. The root path cost is the sum of all path costs along this same path and is the value advertised in Configuration BPDU transmitted from active Spanning Tree ports. The lower the cost value, the closer the switch is to the root.

The type of path cost value used depends on which path cost mode is active (automatic or 32-bit). If the path cost mode is set to automatic, a 16-bit value is used when STP or RSTP is the active protocol and a 32-bit value is used when MSTP is the active protocol. If the mode is set to 32-bit, then a 32-bit path cost value is used regardless of which protocol is active. See [“Configuring the Path Cost Mode” on page 6-32](#) for more information.

If a 32-bit path cost value is in use and the *path_cost* is set to zero, the following IEEE 802.1Q 2005 recommended default path cost values based on link speed are used:

Link Speed	IEEE 802.1D Recommended Value
10 MB	2,000,000
100 MB	200,000
1 GB	20,000

Link Speed	IEEE 802.1D Recommended Value
10 Gbps	2,000

If a 16-bit path cost value is in use and the *path_cost* is set to zero, the following IEEE 802.1D recommended default path cost values based on link speed are used:

Link Speed	IEEE 802.1D Recommended Value
4 Mbps	250
10 Mbps	100
16 Mbps	62
100 Mbps	19
1 Gbps	4
10 Gbps	2

Spanning Tree is automatically enabled on a port and the path cost is set to the default value. If the switch is running in the per-VLAN Spanning Tree mode, then the port path cost applies to the specified VLAN instance associated with the port. If the switch is running in the flat Spanning Tree mode, then the port path cost applies across all VLANs associated with the port. The flat mode instance is specified as the port instance, even if the port is associated with other VLANs.

The **spantree vlan path-cost** command configures the port path cost value for a VLAN instance when the switch is running in either mode (per-VLAN or flat). For example, the following command configures a 16-bit path cost value for port 8/1/1 for VLAN 10 to 19 (the port speed is 100 MB, 19 is the recommended value):

```
-> spantree vlan 10 port 8/1/1 path-cost 19
```

To change the port path cost value for the flat mode instance regardless of which mode (per-VLAN or flat) is active for the switch, use the **spantree cist path-cost** command. For example, the following command configures a 32-bit path cost value for port 1/1/24 for the flat mode instance to 20,000 (the port speed is 1 GB, 20,000 is the recommended value):

```
-> spantree cist port 1/1/24 path-cost 20000
```

The port path cost value is also configurable for a Multiple Spanning Tree Instance (MSTI). To configure this value for an MSTI, use the **spantree msti path-cost** command and specify the MSTI ID for the instance number. For example, the following command configures the path cost value for port 1/1/12 for MSTI 10 to 19:

```
-> spantree msti 10 port 1/1/12 path-cost 19
```

Note that configuring the port path cost value for a MSTI is allowed in both modes (per-VLAN and flat) only when the Spanning Tree protocol is set to MSTP.

Path Cost for Link Aggregate Ports

Physical ports that belong to a link aggregate do not participate in the Spanning Tree Algorithm. Instead, the algorithm is applied to the aggregate logical link (virtual port) that represents a collection of physical ports. Spanning Tree is automatically enabled on the aggregate logical link and the path cost value is set to the default value.

If a 32-bit path cost value is in use and the *path_cost* for a link aggregate is set to zero, the following default values based on link speed and link aggregate size are used:

Link Speed	Aggregate Size (number of links)	Default Path Cost Value
10 MB	2	1,200,000
	4	800,000
	8	600,000
100 MB	2	120,000
	4	80,000
	8	60,000
1 GB	2	12,000
	4	8,000
	8	6,000
10 GB	2	1,200
	4	800
	8	600

If a 16-bit path cost value is in use and the *path_cost* for a link aggregate is set to zero, the following default values based on link speed and link aggregate size are used. Note that for Gigabit ports the aggregate size is not applicable in this case:

Link Speed	Aggregate Size (number of links)	Default Path Cost Value
10 Mbps	2	60
	4	40
	8	30
100 Mbps	2	12
	4	9
	8	7
1 Gbps	N/A	3
10 Gbps	N/A	1

To change the path cost value for a link aggregate, use the **spantree cist path cost**, **spantree msti path cost**, or **spantree vlan path cost** command with the **linkagg** parameter and a link aggregate control (ID) number. For example, the following command sets the path cost for link aggregate 10 associated with VLAN 755 to 19:

```
-> spantree vlan 755 linkagg 10 path-cost 19
```

For more information about configuring an aggregate of ports, see [Chapter 9, “Configuring Static Link Aggregation,”](#) and [Chapter 10, “Configuring Dynamic Link Aggregation.”](#)

Configuring Port Mode

There are two port modes supported: manual and dynamic. Manual mode indicates that the port was set by the user to a forwarding or blocking state. The port operates in the state selected until the state is manually changed again or the port mode is changed to dynamic. Ports operating in a manual mode state do not participate in the Spanning Tree Algorithm. Dynamic mode indicates that the active Spanning Tree Algorithm determines port state.

Spanning Tree is automatically enabled on the port and the port operates in the default mode. If the switch is running in the per-VLAN Spanning Tree mode, then the port mode applies to the specified VLAN instance associated with the port. If the switch is running in the flat Spanning Tree mode, then the port mode applies across all VLANs associated with the port. The flat mode instance is specified as the port instance, even if the port is associated with other VLANs.

To change the port Spanning Tree mode for a VLAN instance regardless of which mode (per-VLAN or flat) is active for the switch, use the **spantree loop-guard** command. For example, the following command sets the mode for port 8/1/1 for VLAN 10 to forwarding.

```
-> spantree vlan 10 port 8/1/1 mode forwarding
```

To change the port Spanning Tree mode for the flat mode instance, use the **spantree cist mode** command. Note that the command is available when the switch is running in either mode (per-VLAN or flat) and an instance number is not required. For example, the following command configures the Spanning Tree mode on port 1/1/24 for the flat mode instance:

```
-> spantree cist port 1/1/24 mode blocking
```

Mode for Link Aggregate Ports

Physical ports that belong to a link aggregate do not participate in the Spanning Tree Algorithm. Instead, the algorithm is applied to the aggregate logical link (virtual port) that represents a collection of physical ports.

To change the port mode for a link aggregate, use the **spantree vlan mode** or the **spantree cist mode** command described above, but specify a link aggregate control (ID) number instead of a port. For example, the following command sets the port mode for link aggregate 10 associated with VLAN 755 to blocking:

```
-> spantree vlan 755 linkagg 10 mode blocking
```

For more information about configuring an aggregate of ports, see [Chapter 9, “Configuring Static Link Aggregation,”](#) and [Chapter 10, “Configuring Dynamic Link Aggregation.”](#)

Configuring Port Connection Type

Specifying a port connection type is done when using the Rapid Spanning Tree Algorithm and Protocol (RSTP), as defined in the IEEE 802.1w standard. RSTP transitions a port from a blocking state directly to forwarding, bypassing the listening and learning states, to provide a rapid reconfiguration of the Spanning Tree in the event of a path or root bridge failure. Rapid transition of a port state depends on the configurable connection type of the port. These types are defined as follows:

- Point-to-point LAN segment (port connects directly to another switch).
- No point-to-point shared media LAN segment (port connects to multiple switches).
- Edge port (port is at the edge of a bridged LAN, does not receive BPDU and has only one MAC address learned). Edge ports, however, will operationally revert to a point to point or a no point to point connection type if a BPDU is received on the port.

A port is considered connected to a point-to-point LAN segment if the port belongs to a link aggregate of ports, or if auto negotiation determines if the port must run in full duplex mode, or if full duplex mode was administratively set. Otherwise, that port is considered connected to a no point-to-point LAN segment.

Rapid transition of a designated port to forwarding can only occur if the port connection type is defined as a point to point or an edge port. Defining a port connection type as a point to point or as an edge port makes the port eligible for rapid transition, regardless of what actually connects to the port. However, an alternate port is always allowed to transition to the role of root port regardless of the alternate port connection type.

Note. Configure ports that will connect to a host (PC, workstation, server, etc.) as edge ports so that these ports will transition directly to a forwarding state and not trigger an unwanted topology change when a device is connected to the port. If a port is configured as a point to point or no point to point connection type, the switch will assume a topology change when this port goes active and will flush and relearn all learned MAC addresses for the port's assigned VLAN.

If the switch is running in the per-VLAN Spanning Tree mode, then the connection type applies to the specified VLAN instance associated with the port. If the switch is running in the flat Spanning Tree mode, then the connection type applies across all VLANs associated with the port. The flat mode instance is referenced as the port instance, even if the port is associated with other VLANs.

By default, Spanning Tree is automatically enabled on the port, the connection type is set to auto point-to-point, and auto edge port detection is enabled. The auto point-to-point setting determines the connection type based on the operational status of the port. The auto edge port setting determines the operational edge port status for the port.

The **spantree vlan connection** and **spantree cist connection** commands are used to configure the port connection type for a VLAN instance or the CIST instance. See [“Configuring the Edge Port Status” on page 6-42](#) for information about configuring the auto edge port status for a port.

To change the port connection type for a VLAN instance regardless of which mode (per-VLAN or flat) is active for the switch, use the **spantree vlan connection** command. For example, the following command defines the connection type for port 8/11 associated with VLAN 10.

```
-> spantree vlan 10 port 8/1/1 connection autoptp
```

To change the port Spanning Tree mode for the flat mode instance regardless of which mode (per-VLAN or flat) is active for the switch, use the **spantree cist connection** command. For example, the following command configures the connection type for port 1/1/24 for the flat mode instance:

```
-> spantree cist port 1/1/24 connection ptp
```

Note. The **spantree vlan connection** and **spantree cist connection** commands only configure one port at a time.

Connection Type on Link Aggregate Ports

Physical ports that belong to a link aggregate do not participate in the Spanning Tree Algorithm. Instead, the algorithm is applied to the aggregate logical link (virtual port) that represents a collection of physical ports. To change the port connection type for a link aggregate, use the **spantree vlan connection** or the **spantree cist connection** command described above, but specify a link aggregate control (ID) number instead of a port. For example, the following command defines the connection type for the link aggregate 10 association with VLAN 755:

```
-> spantree vlan 755 linkagg 10 connection autoptp
```

For more information about configuring an aggregate of ports, see [Chapter 9, “Configuring Static Link Aggregation,”](#) and [Chapter 10, “Configuring Dynamic Link Aggregation.”](#)

Configuring the Edge Port Status

There are two methods for determining the edge port status for a port or link aggregate:

- Configuring the automatic edge (auto edge) port status. The status (enabled or disabled) of this Spanning Tree port parameter specifies whether or not the Spanning Tree automatically determines the operational edge port status for a port. This method is enabled by default.
- Configuring the administrative edge (admin edge) port status. The status (enabled or disabled) of this Spanning Tree port parameter is used to determine the edge port status when the auto edge port status is disabled. This method is disabled by default.

To configure the edge port status for the flat mode instance regardless of which mode (per-VLAN or flat) is active for the switch, use the **spantree cist auto-edge** command or the **spantree cist admin-edge** command. For example:

```
-> spantree cist port 8/1/23 auto-edge enable  
-> spantree cist port 8/1/23 admin-edge disable
```

To configure the edge port status for a VLAN instance regardless of which mode (per-VLAN or flat) is active for the switch, use the **spantree vlan auto-edge** command or the **spantree vlan admin-edge** command. For example:

```
-> spantree vlan 10 port 8/1/23 auto-edge enable  
-> spantree vlan 10 port 8/1/23 admin-edge disable
```

Note. If **auto-edge** is enabled on a port, then the **admin-edge** value is overridden.

Restricting Port Roles (Root Guard)

All ports are automatically eligible for root port selection. A port in a CIST/MSTI instance or per-VLAN instance can be prevented from becoming the root port by restricting the role of the port (also referred to as enabling root guard). This is done using the `spantree cist restricted-role` command or the `spantree vlan restricted-role` command regardless of which mode (per-VLAN or flat) is active for the switch. For example:

```
-> spantree cist port 1/1/2 restricted-role enable
-> spantree cist linkagg 10 restricted-role enable
-> spantree vlan 100 port 8/1/1 restricted-role enable
-> spantree vlan 20 linkagg 1 restricted-role enable
```

Note that the above commands also provide optional syntax; **restricted-role** or **root-guard**. For example, the following two commands perform the same function:

```
-> spantree vlan port 2/1/1 restricted-role enable
-> spantree vlan port 2/1/1 root-guard enable
```

When root guard is enabled for a port, it cannot become the root port, even if it is the most likely candidate for becoming the root port. However, this same port is designated as the alternate port when the root port is selected.

Enabling the restricted role status is used by network administrators to prevent bridges external to the core region of the network from influencing the Spanning Tree topology. However, note that enabling the restricted role status for a port may impact connectivity within the network.

Restricting TCN Propagation

All ports automatically propagate Topology Change Notifications (TCN) or Topology Changes (TC) to other ports. To restrict a port from propagating topology changes and notifications, use the `spantree cist restricted-tcn` command or the `spantree vlan restricted-tcn` command regardless of which mode (per-VLAN or flat) is active for the switch. For example:

```
-> spantree cist port 2/1/2 restricted-tcn enable
-> spantree cist linkagg 5 restricted-tcn enable
-> spantree vlan 10 port 1/1/5 restricted-tcn enable
-> spantree vlan 20 linkagg 1 restricted-tcn enable
```

Enabling the restricted TCN status is used by network administrators to prevent bridges external to the core region of the network from causing unnecessary MAC address flushing in that region. However, note that enabling the restricted TCN status for a port may impact Spanning Tree connectivity.

Limiting BPDU Transmission

The number of BPDUs to be transmitted per port per second can be limited using the `spantree cist txholdcount` command for a CIST instance or the `spantree vlan txholdcount` command for a per-VLAN instance. Both of these commands apply to all ports and link aggregates and are supported when the switch is running in either the per-VLAN mode or the flat mode. For example:

```
-> spantree cist txholdcount 5
-> spantree vlan 10 txholdcount 5
```

Sample Spanning Tree Configuration

This section provides an example network configuration in which the Spanning Tree Algorithm and Protocol has calculated a loop-free topology. In addition, a tutorial is also included that provides steps on how to configure the example network topology using the Command Line Interface (CLI).

Note that the following example network configuration illustrates using switches operating in the per-VLAN Spanning Tree mode and using RSTP (802.1w) to calculate a single data path between VLANs. See “[MST General Overview](#)” on page 6-13 for an overview and examples of using MSTP (802.1s).

Example Network Overview

The following diagram shows a four-switch network configuration with an active Spanning Tree topology, which was calculated based on both configured and default Spanning Tree parameter values:

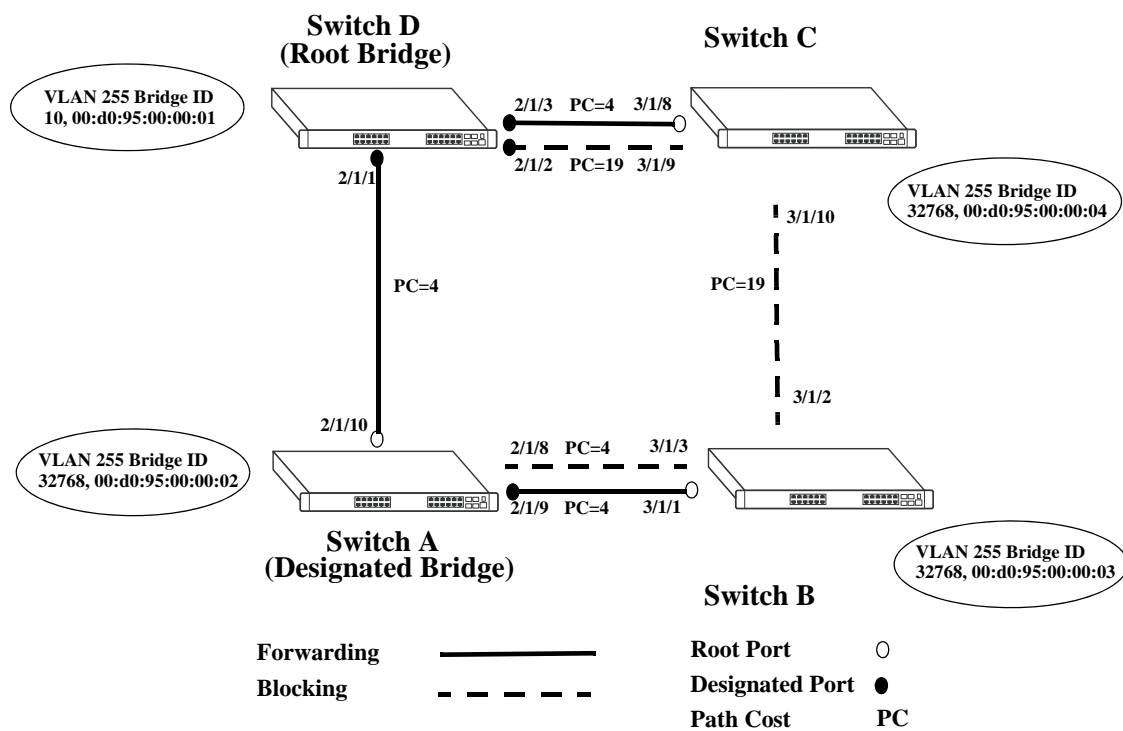

Example Active Spanning Tree Topology

In the above example topology:

- Each switch is operating in the per-VLAN Spanning Tree mode by default.
- Each switch configuration has a VLAN 255 defined. The Spanning Tree administrative status for this VLAN was enabled by default when the VLAN was created.
- VLAN 255 on each switch is configured to use the 802.1w (rapid reconfiguration) Spanning Tree Algorithm and Protocol.
- Ports 2/1/1-3, 2/1/8-10, 3/1/1-3, and 3/1/8-10 provide connections to other switches and are all assigned to VLAN 255 on their respective switches. The Spanning Tree administrative status for each port is enabled by default.

- The path cost for each port connection defaults to a value based on the link speed. For example, the connection between Switch B and Switch C is a 100 Mbps link, which defaults to a path cost of 19.
- VLAN 255 on Switch D is configured with a Bridge ID priority value of 10, which is less than the same value for VLAN 255 configured on the other switches. As a result, VLAN 255 was elected the Spanning Tree root bridge for the VLAN 255 broadcast domain.
- A root port is identified for VLAN 255 on each switch, except the root VLAN 255 switch. The root port identifies the port that provides the best path to the root VLAN.
- VLAN 255 on Switch A was elected the designated bridge because it offers the best path cost for Switch B to the root VLAN 255 on Switch D.
- Port 1/2/9 on Switch A is the designated port for the Switch A to Switch B connection because Switch A is the designated bridge for Switch B.
- Redundant connections exist between Switch D and Switch C. Ports 2/1/2 and 3/1/9 are in a discarding (blocking) state because this connection has a higher path cost than the connection provided through ports 2/1/3 and 3/1/8. As a result, a network loop condition is avoided.
- Redundant connections also exist between Switch A and Switch B. Although the path cost value for both of these connections is the same, ports 2/1/8 and 3/1/3 are in a discarding state because their port priority values (not shown) are higher than the same values for ports 2/1/10 and 3/1/1.
- The ports that provide the connection between Switch B and Switch C are in a discarding (blocking) state, because this connection has a higher path cost than the other connections leading to the root VLAN 255 on Switch D. As a result, a network loop is avoided.

Example Network Configuration Steps

The following steps provide a quick tutorial that configures the active Spanning Tree network topology shown in the diagram on [page 6-44](#).

1 Create VLAN 255 on Switches A, B, C, and D with “Marketing IP Network” for the VLAN description on each switch using the following command:

```
-> vlan 255 name "Marketing IP Network"
```

2 Assign the switch ports that provide connections between each switch to VLAN 255. For example, the following commands entered on Switches A, B, C, and D, respectively, assign the ports shown in the example network diagram on [page 6-44](#) to VLAN 255:

```
-> vlan 255 members port 2/1/8-10 untagged
-> vlan 255 members port 3/1/1-3 untagged
-> vlan 255 members port 3/1/8-10 untagged
-> vlan 255 members port 2/1/1-3 untagged
```

3 Change the Spanning Tree protocol for VLAN 255 to RSTP (Rapid Spanning Tree Protocol) on each switch using the following command:

```
-> spantree vlan 255 protocol rstp
```

4 Change the bridge priority value for VLAN 255 on Switch D to **10** using the following command (leave the priority for VLAN 255 on the other three switches set to the default value):

```
-> spantree vlan 255 priority 10
```

VLAN 255 on Switch D has the lowest Bridge ID priority value of all four switches, which qualifies it as the Spanning Tree root VLAN for the VLAN 255 broadcast domain.

Note. To verify the VLAN 255 Spanning Tree configuration on each switch use the following **show** commands. The following outputs are for example purposes only and not match values shown in the sample network configuration:

```
-> show spantree vlan 255
Spanning Tree Parameters for Vlan 255
Spanning Tree Status :                ON,
Protocol              :                IEEE RAPID STP,
mode                  :                per vlan (1 STP per Vlan),
Priority               :                32768(0x0FA0),
Bridge ID              :                8000-00:d0:95:00:00:04,
Designated Root       :                000A-00:d0:95:00:00:01,
Cost to Root Bridge   :                4,
Root Port              :                Slot 3 Interface 8,
Next Best Root Cost   :                0,
Next Best Root Port   :                None,
Tx Hold Count         :                6,
Topology Changes      :                3,
Topology age          :                0:4:37
Current Parameters (seconds)
Max Age                =                30,
Forward Delay          =                15,
Hello Time             =                2
Parameters system uses when attempting to become root
System Max Age         =                30,
System Forward Delay   =                15,
System Hello Time      =                2
```

```
-> show spantree vlan 255 ports
Spanning Tree Port Summary for Vlan 255
      Adm Oper Man. Path Desig      Prim. Op Op
Port  Pri St  St  mode Cost Cost Role Port Cnx Edg  Desig Bridge ID
-----+-----+-----+-----+-----+-----+-----+-----+-----+-----+-----+-----+-----+-----+-----+-----
3/1/8  7 ENA FORW No   4   29 ROOT 3/1/8 NPT Edg 000A-00:d0:95:00:00:01
3/1/9  7 ENA BLOCK No  19  48 BACK 3/1/9 NPT No  8000-00:d0:95:00:00:04
3/1/10 7 ENA BLOCK No  19  48 ALTN 3/1/10 NPT No  8000-00:d0:95:00:00:03
```

Sample MST Region Configuration

An MST region identifies a group of MSTP switches that is seen as a single, flat mode instance by other regions and/or non-MSTP switches. A region is defined by three attributes: name, revision level, and a VLAN-to-MSTI mapping. Switches configured with the same value for all three of these attributes belong to the same MST region.

Note. An additional configurable MST region parameter defines the maximum number of hops authorized for the region but is not considered when determining regional membership. The maximum hops value is the value used by all bridges within the region when the bridge is acting as the root of the MST region.

This section provides a tutorial for defining a sample MST region configuration, as shown in the diagram below:

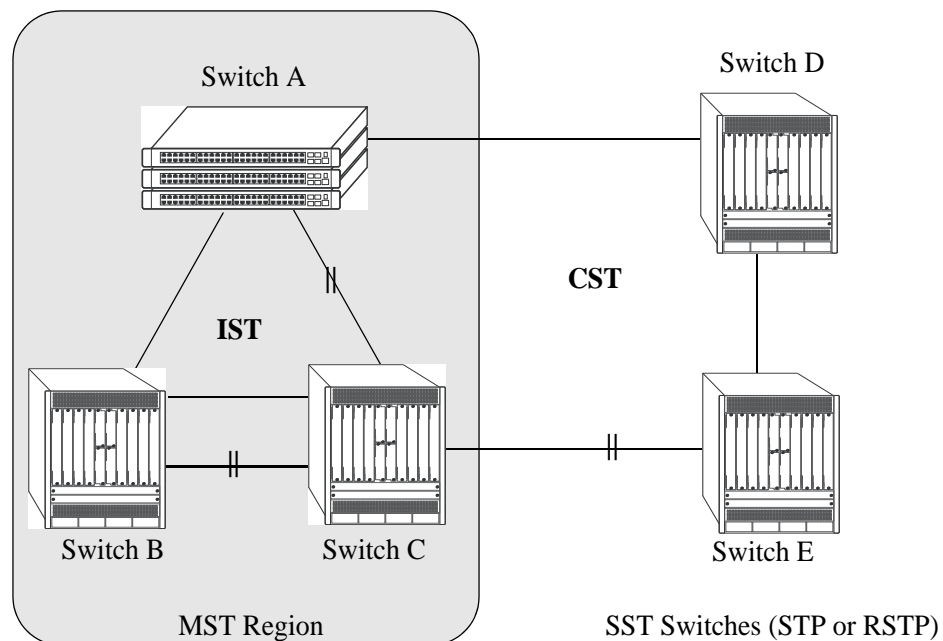

In order for switches A, B, and C in the above diagram to belong to the same MST region, they must all share the same values for region name, revision level, and configuration digest (VLAN-to-MSTI mapping).

The following steps are performed on each switch to define **Alcatel-Lucent Marketing** as the MST region name, **2000** as the MST region revision level, map exiting VLANs to existing MSTIs, and **3** as the maximum hops value for the region:

- 1 Configure an MST Region name using the **spantree mst region name** command. For example:

```
-> spantree mst region name "Alcatel Marketing"
```
- 2 Configure the MST Region revision level using the **spantree mst region revision-level** command. For example:

```
-> spantree mst region revision-level 2000
```

3 Map VLANs 100 and 200 to MSTI 2 and VLANs 300 and 400 to MSTI 4 using the **spantree msti vlan** command to define the configuration digest. For example:

```
-> spantree msti 2 vlan 100 200
-> spantree msti 4 vlan 300 400
```

See the “[Sample MSTI Configuration](#)” on page 6-49 for a tutorial on how to create and map MSTIs to VLANs.

4 Configure **3** as the maximum number of hops for the region using the **spantree mst region max-hops** command. For example:

```
-> spantree mst region max-hops 3
```

Note. (Optional) Verify the MST region configuration on each switch with the **show spantree mst** command. For example:

```
-> show spantree mst region

Configuration Name      = Alcatel Marketing,
Revision Level         = 2000,
Configuration Digest   = 0x922fb3f 31752d68 67fe1155 d0ce8380,
Revision Max hops     = 3,
Cist Instance Number   = 0
```

All switches configured with the exact same values as shown in the above example are considered members of the Alcatel-Lucent Marketing MST region.

Sample MSTI Configuration

By default, the Spanning Tree software is active on all switches and operating in the per-VLAN mode using 802.1w RSTP. A loop-free network topology is automatically calculated based on default 802.1w RSTP switch, bridge, and port parameter values.

Using Multiple Spanning Tree (MST) requires configuration changes to the default Spanning Tree values (mode and protocol) as well as defining specific MSTP parameters and instances.

The following steps provide a tutorial for setting up a sample MSTP configuration, as shown in the diagram below:

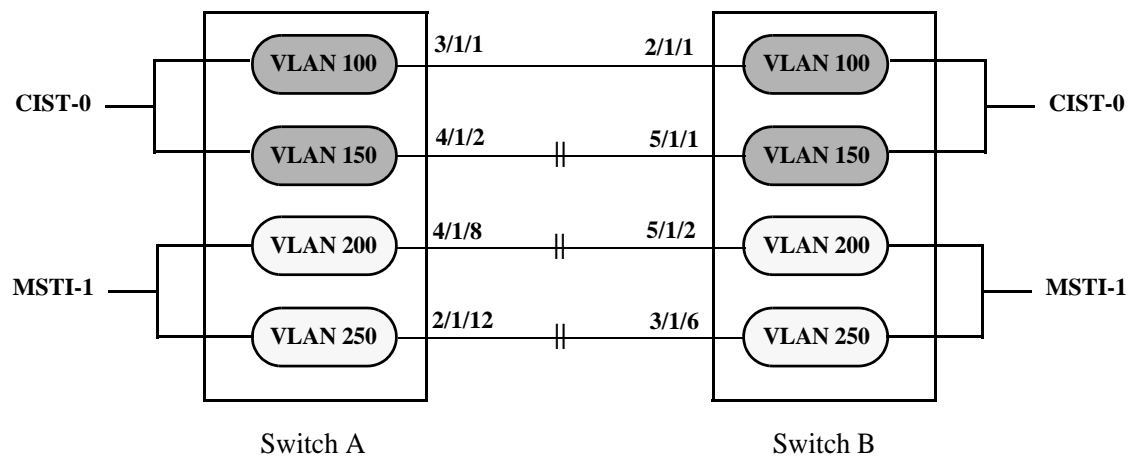

Flat Mode MSTP Quick Steps Example

- 1 Change the Spanning Tree operating mode, if necessary, on Switch A and Switch B from per-VLAN to flat mode using the `spantree mode` command. For example:

```
-> spantree mode flat
```

Note that defining an MSTP configuration requires the use of explicit Spanning Tree commands, which are available in both the flat and per-VLAN mode. As a result, this step is optional. See [“Using Spanning Tree Configuration Commands”](#) on page 6-26 for more information.

- 2 Change the Spanning Tree protocol to MSTP using the `spantree protocol` command. For example:

```
-> spantree protocol mstp
```

- 3 Create VLANs 100, 200, 300, and 400 using the `vlan` command. For example:

```
-> vlan 100
-> vlan 150
-> vlan 200
-> vlan 250
```

- 4 Assign switch ports to VLANs, as shown in the above diagram, using the `vlan members untagged` command. For example, the following commands assign ports 3/1/1, 4/1/2, 4/1/8, and 2/1/12 to VLANs 100, 150, 200, and 250 on Switch A:

```
-> vlan 100 members port 3/1/1 untagged
-> vlan 150 members port 4/1/2 untagged
-> vlan 200 members port 4/1/8 untagged
-> vlan 250 members port 2/1/12 untagged
```

The following commands assign ports 2/1/1, 5/1/1, 5/1/2, and 3/1/6 to VLANs 100, 150, 200, and 250 on Switch B:

```
-> vlan 100 members port 2/1/1 untagged
-> vlan 150 members port 5/1/1 untagged
-> vlan 200 members port 5/1/2 untagged
-> vlan 250 members port 3/1/6 untagged
```

5 Create one MSTI using the **spantree msti** command. For example:

```
-> spantree msti 1
```

6 Assign VLANs 200 and 250 to MSTI 1. For example:

```
-> spantree msti 1 vlan 100 200
```

All VLANs are associated with the CIST instance. As a result, VLANs 100 and 150 do not require any configuration to map them to the CIST instance.

7 Configure the port path cost (PPC) for all ports on both switches associated with MSTI 1 to a PPC value that is lower than the PPC value for the ports associated with the CIST instance using the **spantree msti path-cost** command. For example, the PPC for ports associated with the CIST instance is set to the default of 200,000 for 100 MB connections. The following commands change the PPC value for ports associated with the MSTI 1 to 20,000:

```
-> spantree msti 1 port 4/1/8 path-cost 20000
-> spantree msti 1 port 2/1/12 path-cost 20000
-> spantree msti 1 port 5/1/2 path-cost 20000
-> spantree msti 1 port 3/1/6 path-cost 20000
```

Note. In this example, port connections between VLANs 150, 200, and 250 are blocked on each switch initially, as shown in the diagram on [page 6-49](#). This is because in flat mode MSTP, each instance is active on all ports resulting in a comparison of connections independent of VLAN and MSTI associations.

To avoid this and allow VLAN traffic to flow over separate data paths based on MSTI association, Step 7 of this tutorial configures a superior port path cost value for ports associated with MSTI 1. As a result, MSTI 1 selects one of the data paths between its VLANs as the best path, rather than the CIST data paths, as shown in the diagram on [page 6-51](#).

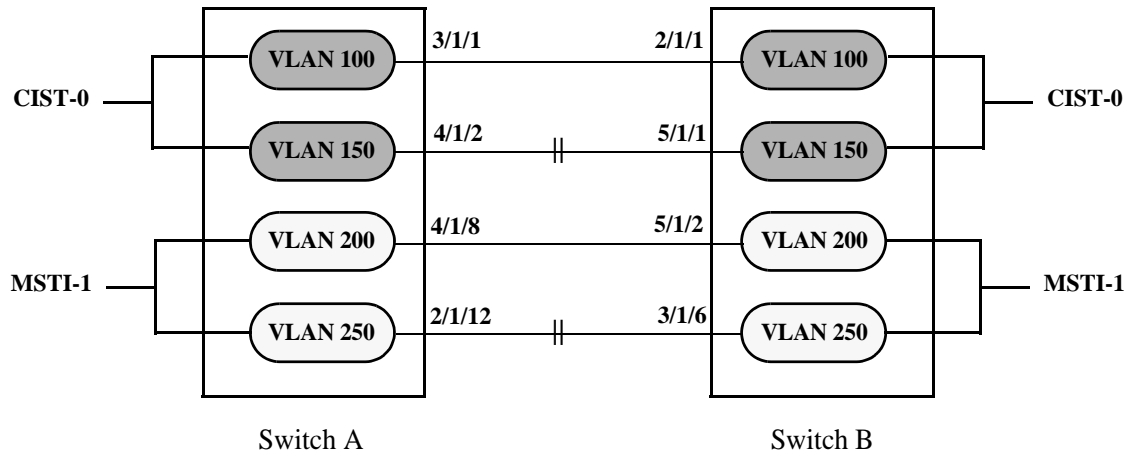

Flat Mode MSTP with Superior MSTI 1 PPC Values

Note. Of the two data paths available to MSTI 1 VLANs, one is blocked because it is considered redundant for that instance. In addition, the CIST data path remains available for CIST VLAN traffic.

Another solution to this scenario is to assign all VLANs to an MSTI, leaving no VLANs controlled by the CIST. As a result, the CIST BPDU contains only MSTI information. See [“How MSTP Works” on page 6-13](#) for more information.

Verifying the Spanning Tree Configuration

To display information about the Spanning Tree configuration on the switch, use the show commands listed below:

show spantree cist	Displays the Spanning Tree bridge configuration for the flat mode Common and Internal Spanning Tree (CIST) instance.
show spantree msti	Displays Spanning Tree bridge information for a Multiple Spanning Tree Instance (MSTI).
show spantree vlan	Displays the Spanning Tree bridge information for a VLAN instance.
show spantree cist ports	Displays Spanning Tree port information for the flat mode Common and Internal Spanning Tree (CIST) instance.
show spantree msti ports	Displays Spanning Tree port information for a flat mode Multiple Spanning Tree Instance (MSTI).
show spantree vlan ports	Displays Spanning Tree port information for a VLAN instance.
show spantree mst	Displays the Multiple Spanning Tree (MST) information for a MST region or the specified port or link aggregate on the switch.
show spantree cist vlan-map	Displays the range of VLANs associated with the flat mode Common and Internal Spanning Tree (CIST) instance.
show spantree msti vlan-map	Displays the range of VLANs associated with the specified Multiple Spanning Tree Instance (MSTI).
show spantree map-msti	Displays the Multiple Spanning Tree Instance (MSTI) that is associated to the specified VLAN.
show spantree mode	Displays the current global Spanning Tree mode parameter values for the switch, such as the current running mode (per-VLAN or flat) for the switch

For more information about the resulting displays from these commands, see the *OmniSwitch AOS Release 8 CLI Reference Guide*. An example of the output for the **show spantree vlan** and **show spantree vlan ports** commands is also given in “[Example Network Configuration Steps](#)” on page 6-45.

7 Configuring Shortest Path Bridging

The Alcatel-Lucent OmniSwitch supports Shortest Path Bridging MAC (SPB-M), as defined in the IEEE 802.1aq standard. SPB-M uses the Provider Backbone Bridge (PBB) network model to encapsulate (using IEEE 802.1ah headers) and tunnel customer traffic through the network backbone. The shortest path trees upon which the PBB network infrastructure operates are determined using a version of the Intermediate System-to-Intermediate System (IS-IS) link state protocol that supports TLV extensions for SPB (ISIS-SPB).

Incorporating SPB-M into the network infrastructure provides the following benefits:

- Transparently extends Layer 2 connections (VLAN segments) across a large virtual service Layer 2 backbone network.
- Maintains a loop-free network while providing efficient use of available bandwidth, especially in a mesh topology. All connections between all switches in the topology remain active (no blocking of redundant links).
- A shortest path is automatically calculated between each bridge and every other bridge in the data center mesh, resulting in low latency and sub-second convergence times needed to support critical network bridging requirements.
- Can process a large number of customer MAC addresses without overrunning provider network resources. Customer MAC addresses are only learned on Backbone Edge Bridges (BEB), where customer traffic is then encapsulated and tunneled through the network core infrastructure. Backbone Core Bridges (BCB) do not have to learn any customer MAC addresses.
- Provides a clear separation of customer traffic (between different customers and between the provider network domain). Entry points for customer traffic are clearly defined on the participating BEBs. Customer traffic is identified and associated with a specific service instance bound to the PBB infrastructure.

In This Chapter

This chapter provides an overview about how Shortest Path Bridging MAC (SPB-M) works and how to configure SPB-M through the Command Line Interface (CLI). CLI commands are used in the configuration examples; for more details about the syntax of commands, see the *OmniSwitch AOS Release 8 CLI Reference Guide*.

This chapter includes the following topics:

- “Shortest Path Bridging Specifications” on page 7-3.
- “SPB-M Parameter Defaults” on page 7-4.
- “SPB-M Interface Defaults” on page 7-4.
- “SPB-M Service Defaults” on page 7-5.
- “Shortest Path Bridging Overview” on page 7-6.
- “IP over SPBM” on page 7-15.
- “Interaction With Other Features” on page 7-18.
- “Quick Steps for Configuring SPB-M” on page 7-21.
- “Configuring SPB-M” on page 7-24.
- “Verifying the SPB Backbone and Services” on page 7-54.

Shortest Path Bridging Specifications

The Shortest Path Bridging functionality described in this chapter is supported unless otherwise stated in the following specifications table or specifically noted within any other section of this chapter. Note that any maximum limits provided in this table are subject to available system resources.

Platforms Supported	OmniSwitch 6860, 6860E
OmniSwitch Software License	Advanced
IEEE Standards Supported	802.1aq/D3.6: Draft February 10, 2011— <i>Virtual Bridged Local Area Networks-Amendment 9: Shortest Path Bridging</i> 802.1ah/D4.2: DRAFT March 26, 2008— <i>Virtual Bridged Local Area Networks–Amendment 6: Provider Backbone Bridging</i>
IETF Internet-Drafts Supported	draft-ietf-isis-ieee-aq-05.txt— <i>ISIS Extensions Supporting IEEE 802.1aq Shortest Path Bridging</i> IETF draft— <i>IP/IPVPN services with IEEE 802.1aq SPBB networks</i> IETF draft— <i>IP/IPVPN services with IEEE 802.1aq SPB networks</i>
SPB mode supported	SPB-M (MAC-in-MAC)
IP over SPBM	IPv4 (VPN-Lite and L3 VPN) VRF-to-ISID mapping (one-to-one, one-to-many)
Maximum number of ISIS-SPB instances per switch.	1
Maximum number of BVLANS per switch	16
Number of equal cost tree (ECT) algorithm IDs supported.	16 (Can select any ID between 1 and 16 to assign to a BVLAN)
Maximum number of service instance identifiers (I-SIDs) per switch	2K
Maximum number of VLANs or SVLANs per I-SID	2K
Maximum number of SAPS	2K
Maximum Transmission Unit (MTU) size for SPB services.	9K (not configurable at this time)

SPB-M Parameter Defaults

Parameter Description	Command	Default
ISIS-SPB status for the switch.	spb isis admin-state	Disabled
Equal Cost Tree (ECT) ID number for the backbone VLAN (BVLAN).	spb isis bvlan ect-id	1 or next available ECT ID number on the local switch.
Control BVLAN for the switch.	spb isis control-bvlan	None
The BVLAN tandem multicast mode (only applies to associated SPB services running in tandem mode).	spb isis bvlan tandem-multicast-mode	Source and Group (S, G)
Priority value for the ISIS-SPB instance.	spb isis bridge-priority	32768
Wait time intervals, in milliseconds, for shortest path first (SPF) calculations.	spb isis spf-wait	maximum wait: 1000 initial wait : 100 second wait : 300
Wait time intervals, in milliseconds, for link state PDU (LSP) transmissions.	spb isis lsp-wait	maximum wait: 1000 initial wait : 0 second wait : 300
Graceful restart status for the switch.	spb isis graceful-restart	Disabled
Graceful restart helper status for the switch.	spb isis graceful-restart helper	Disabled

SPB-M Interface Defaults

Parameter Description	Command	Default
SPB interface status	spb isis interface	Disabled
SPB interface time interval between each hello packet transmission.	spb isis interface hello-interval	9 seconds
SPB interface hello multiplier used to determine hello packet hold time.	spb isis interface hello-multiplier	3
SPB interface link cost to reach the peer bridge.	spb isis interface metric	10

SPB-M Service Defaults

By default, there are no SPB-M service components configured for the switch. However, when a service is created, the following default values apply:

Parameter Description	Command	Default
SPB service administrative status.	service spb admin-state	Disabled
SPB service multicast replication mode.	service spb multicast-mode	Head-end
SPB service VLAN translation.	service spb vlan-xlation	Disabled
SPB service maximum transmission unit (MTU) value.	Not configurable at this time	9194
SPB service statistics collection.	service spb stats	Disabled
SPB service description.	service spb description	None.
Default profile automatically applied to access ports.	service access l2profile	def-access-profile
Layer 2 profile that specifies how control packets are processed on service access ports.	service l2profile	def-access-profile: STP, GVRP, MVRP = tunnel 802.3ad = peer 802.1x, 802.1ab, AMAP = drop CSCO PDU, VLAN, uplink = drop
VLAN translation for the service access port.	service access vlan-xlation	Disabled
Service access point (SAP) administrative status.	service spb sap admin-state	Disabled
SAP encapsulation.	service spb sap	0 (untagged traffic).
SAP trust mode.	service spb sap trusted	Trusted
SAP statistics collection.	service spb sap stats	Disabled
SAP description.	service spb sap description	None

Shortest Path Bridging Overview

The Alcatel-Lucent OmniSwitch implementation of Shortest Path Bridging (SPB) supports SPB MAC (SPB-M) as defined in the IEEE 802.1aq standard. SPB-M is defined for use in Provider Backbone Bridge (PBB) networks as specified in the IEEE 802.1ah standard.

SPB-M provides a mechanism to automatically define a shortest path tree (SPT) bridging configuration through a Layer 2 Ethernet network. SPB-M Ethernet services use this configuration to encapsulate and tunnel data through the PBB network. The following main components of the OmniSwitch implementation of SPB-M provide this type of functionality:

- **ISIS-SPB**—A version of the Intermediate to Intermediate System (IS-IS) link state protocol that supports SPB TLV extensions. SPB-M uses ISIS-SPB to build sets of symmetric shortest path trees (SPTs) between any SPB switch.
- **Provider Backbone Bridge (PBB) IEEE 802.1ah**— Defines a MAC-in-MAC data encapsulation path for PBB networks that is supported by SPB-M.
- **Provider Backbone Bridge Network (PBBN)**—A network comprised of Backbone Edge Bridges (BEBs) and Backbone Core Bridges (BCB) that is used to interconnect Provider Bridge Networks (PBN) with other networks.
- **Backbone Edge Bridge (BEB)**—An SPB switch positioned at the edge of the PBB network that learns and encapsulates (adds an 802.1ah backbone header to) customer frames for transport across the backbone network. The BEB interconnects the customer network space with PBB network space.
- **Backbone Core Bridge (BCB)**—An SPB node that resides inside the PBB network core. The BCB employs the same BVLAN on two or more network ports. This BVLAN does not terminate on the switch itself; traffic ingressing on an SPB network port is switched to other SPB network ports. As a result, the BCB does not have to learn any of the customer MAC addresses. It mainly serves as a transit bridge for the PBB network.
- **SPB-M Service**—An OmniSwitch Service Manager service configured on the BEBs. Each service maps to a service instance identifier (I-SID) which is bound to a backbone VLAN. One backbone VLAN can accommodate multiple I-SIDs.
- **Backbone VLAN (BVLAN)**—A VLAN that serves as a transport VLAN for the SPB-M service instances and to connect SPB bridges together through SPT sets. Unlike standard VLANs, BVLANs do not learn source MAC addresses or flood unknown destination or multicast frames. Instead, BVLANs only forward on the basis of the forwarding database (FDB) as populated by the ISIS-SPB protocol.

The following illustration shows how SPB-M uses the above components to tunnel customer traffic through a Provider Backbone Bridge Network:

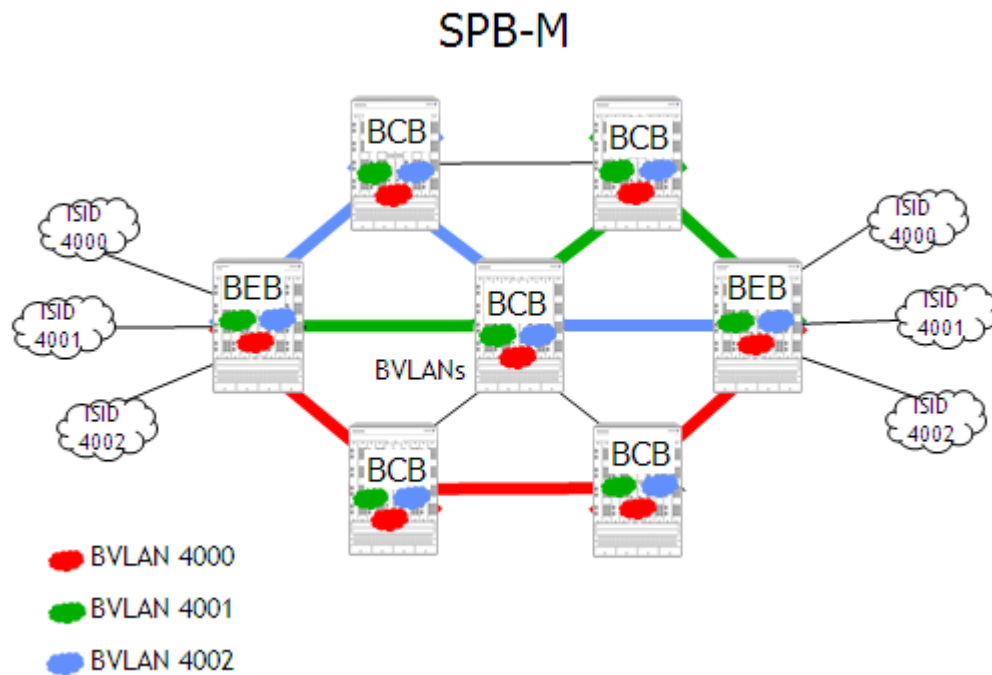

Figure 1: SPB-M Network Components

In this network,

- The BEBs are SPB-M capable (ISIS-SPB configured and enabled) and form a shortest path bridging network that also includes the SPB-M capable Backbone Core Bridges (BCBs).
- Each bridge calculates a shortest path tree (SPT) for each BVLAN with itself as the root of each tree.
- SPB Ethernet service instances identified by I-SIDs are created on each BEB. Each I-SID is associated with a BVLAN ID. The BVLAN is configured on each bridge (BEB and BCB) in the backbone network. However, the I-SID itself and the I-SID association with the BVLAN is only configured on each BEB that will service customer traffic.
- A Service Access Point (SAP) is configured on each BEB to identify the access port on which customer traffic will enter the PBBN, the SPB service instance that will tunnel the traffic through the network, and the type of customer traffic to forward (for example, only specific CVLAN IDs, untagged traffic only, or all tagged traffic). Basically, the SAP binds access ports and the specified customer traffic received on those ports to the service.
- Layer 2 traffic from the connected edge networks enters the BEBs through access ports. The SAP configuration on the receiving access port is applied to classify which frames are mapped to which services, if any.
- Classified traffic is then encapsulated into 802.1ah frames by the BEB before the frames are transmitted through the backbone network.
- The 802.1ah encapsulated frames are forwarded on the shortest path through the entire PBBN to reach the intended destination BEB. The BCBs switch traffic based on the destination backbone MAC address (BMAC)—bridge MAC address of the BEB—provided in the 802.1ah header and do not process any I-SID information in the frame.

SPB-M Shortest Path Trees

The shortest path between two points is a straight line. Shortest Path Bridging (SPB) implements frame forwarding on the shortest path between any two bridges in an Ethernet network. The shortest path trees (SPTs) calculated by SPB provide the shortest and most efficient path to and from the intended destination. SPTs are formed along the direct, straight-line links between switches to make up an overall path through the topology that provides a robust, efficient direction for network traffic to travel.

The SPB-M network topology consists of two layers:

- **The backbone infrastructure (control plane) layer.** ISIS-SPB builds the backbone layer by defining loop-free, shortest path trees (SPTs) through the backbone network.
- **The services (data plane) layer.** The service layer is based on the Provider Backbone Bridging (PBB) framework as defined in the IEEE 802.1ah standard. SPB-M supports the 802.1ah MAC-in-MAC method for data encapsulation. SPB-M services transport the encapsulated traffic over the ISIS-SPB infrastructure. (See “[SPB Services](#)” on page 7-12 for more information).

This section contains an example of ISIS-SPB operations in a small SPB-M network. In addition to describing how shortest path trees are created in the BVLAN domain, the flow of unicast and multicast traffic through the network, this example also shows the benefits of using SPB over Spanning Tree for VLAN traffic distribution.

Spanning Tree

The following diagram shows an example Provider Backbone Bridge (PBB) network with a single backbone VLAN using the Spanning Tree protocol for network loop protection with the same path cost on all links:

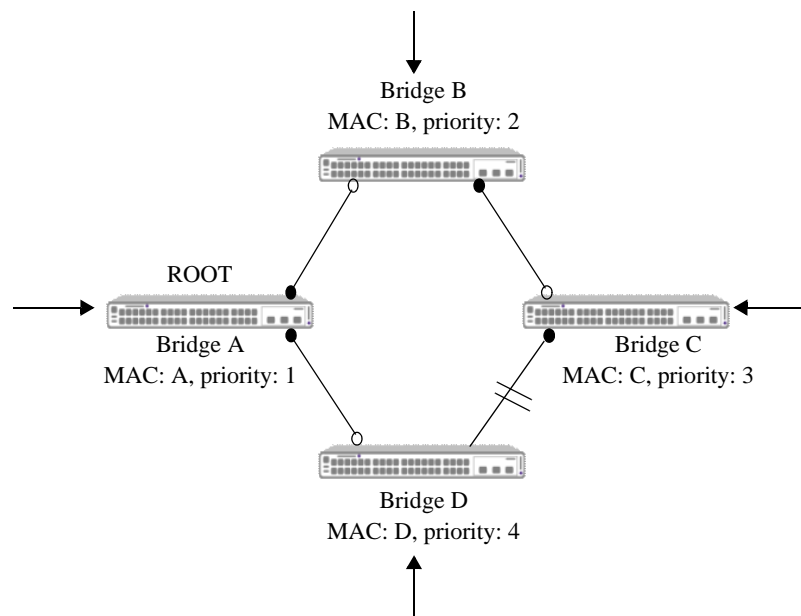

Figure 2: Spanning Tree Topology

In this example, Bridge A is the Root bridge. As a result, customer traffic entering Bridge A would always use the shortest path to reach every other bridge in the network. However, traffic entering Bridge D that is destined for Bridge C must traverse the path through Bridge A to reach Bridge C, even though Bridge D is directly connected to Bridge C. Clearly the path from Bridge D to Bridge C is not the shortest path in this case.

ISIS-SPB

The IEEE 802.1aq standard for SPB specifies the use of the IS-IS link state protocol instead of Spanning Tree to form sets of shortest path trees through the network. When SPB is used, each bridge is the Root for all traffic entering that bridge. As a result, each bridge can provide the shortest path to every other bridge in the network.

The bridging methodology needed to allow each bridge to serve as its own root bridge is enforced through the use of SPB BVLANS. This type of VLAN does not learn customer MAC addresses or flood unknown unicast and multicast traffic. In addition, network loops are mitigated through strict ingress checks based on the source MAC address of frames received on the BVLAN (frames received from an unexpected source are discarded).

SPB-M uses an extended version of the IS-IS protocol that supports SPB (ISIS-SPB) to calculate the SPB-M network topology. In addition, the learning and propagation of source MAC addresses is handled through the ISIS-SPB control plane, instead of through the data plane.

When calculating the SPB-M network topology, ISIS-SPB must meet Layer 2 requirements to create congruent and symmetric paths. To do this, SPB-M supports 16 predefined Equal Cost Tree (ECT) algorithms to break ties when two or more equal cost paths to the same destination are discovered. The same ECT algorithm is configured for the same BVLAN ID on each SPB switch in the network to ensure congruent, symmetric paths for the service traffic bound to that BVLAN.

Basically, to create a unicast tree, SPB-M simply computes the shortest path from every bridge with each bridge serving as the Root (as shown below) and populates the Layer 2 forwarding database (FDB) on the SPB bridges with MAC addresses.

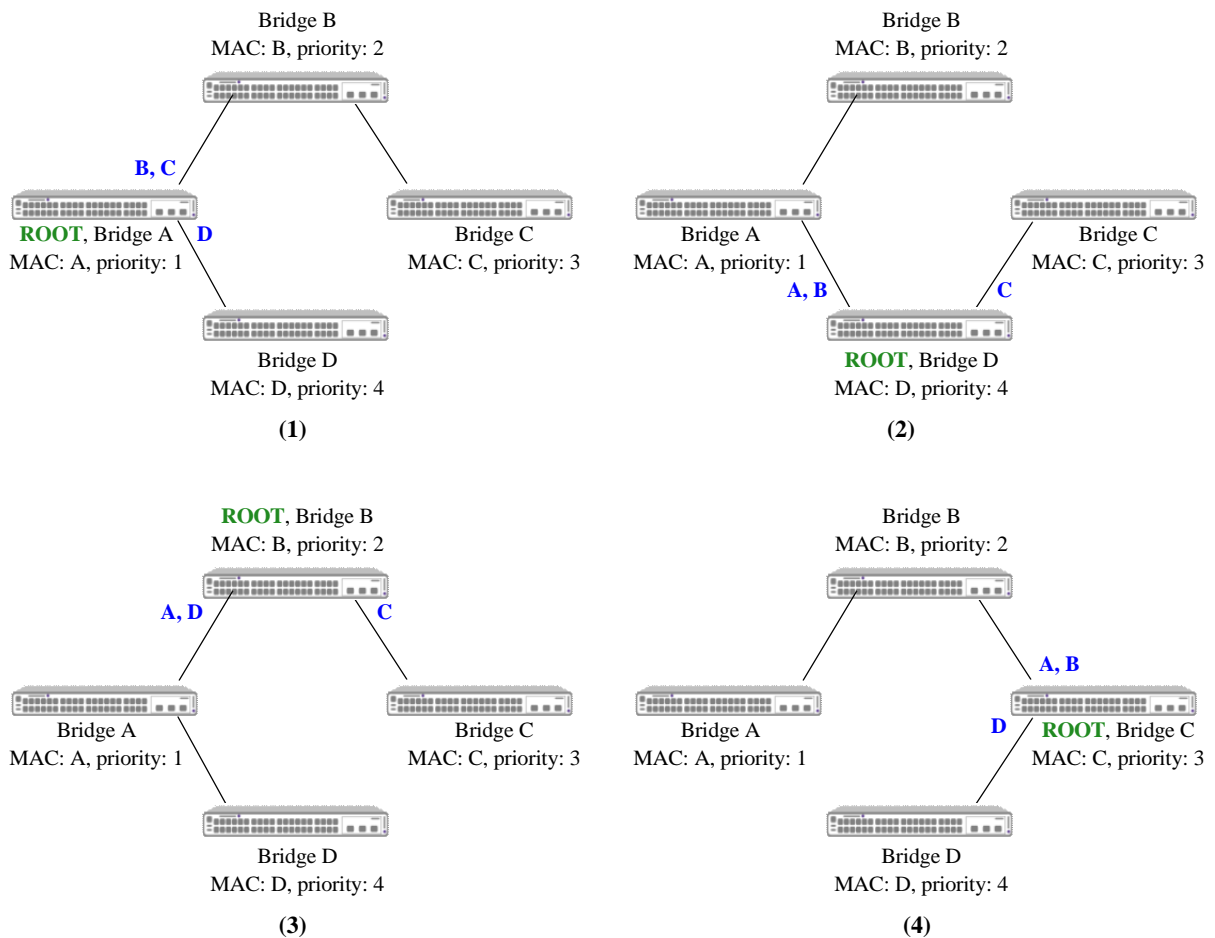

Figure 3: ISIS-SPB Shortest Path Calculations

The ISIS-SPB unicast trees shown in Figure 3 were built as follows:

- 1** Bridge A calculates the shortest path tree to Bridge B and then programs its FDB with MAC address B on the link, as shown in 4(1).
- 2** Bridge A will then calculate shortest paths to Bridge C and Bridge D and programs the MAC addresses according to the path computed.
- 3** All other bridges follow the same procedure (note that the actual computation is much more optimized and the description here is only for illustration purposes).
- 4** The following traffic pattern for this example network is the result of the ISIS-SPB SPT calculations:

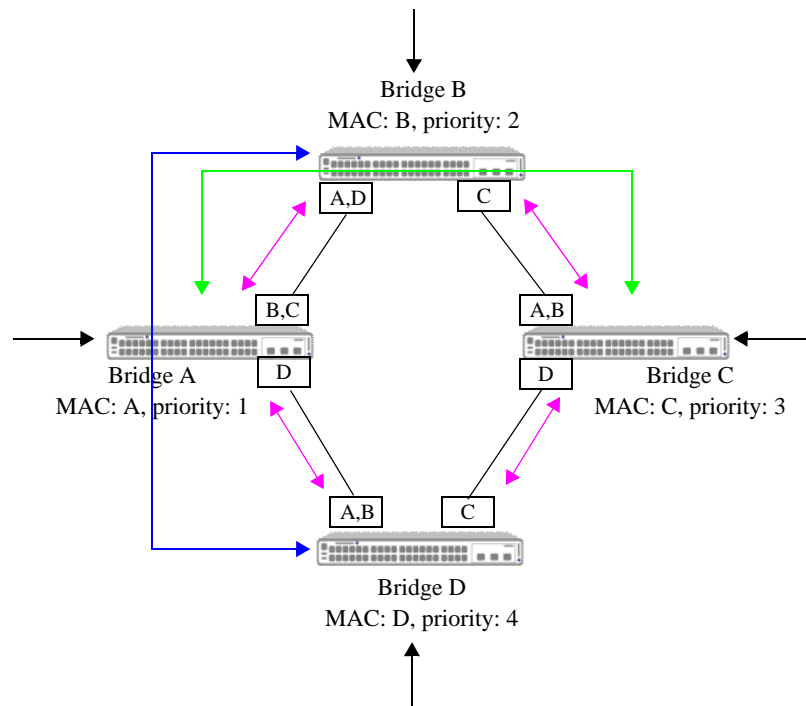

Figure 4: ISIS-SPB Topology

As shown in Figure 4, all the backbone MAC (BMAC) addresses are learned by the switches when ISIS-SPB converges. The path taken by each unicast flow (for example ABC, CBA) are reverse path congruent and travel the shortest path through the network.

In the ISIS-SPB topology (Figure 4), the link between Bridge D and Bridge C carries traffic, whereas in the Spanning Tree topology (Figure 3), this link is blocked. Although these examples are based on traffic distribution for a single BVLAN, the ability to make all links in the topology available at all times is especially advantageous in highly redundant, meshed networks.

Although the link between Bridge D and Bridge C is used in the ISIS-SPB topology, traffic flow is relatively low in comparison to the other links. To make better use of this link, a second BVLAN could be created and assigned a different ECT algorithm to trigger ISIS-SPB calculations of a separate set of SPTs for the second BVLAN. This is similar to creating a new Multiple Spanning Tree (MST) instance in a Spanning Tree topology to create a different tree and assigning a new VLAN to that instance.

Each ECT algorithm uses a different calculation to break ties when paths between SPB bridges are equal cost. Another method to influence the SPT calculation is to modify the bridge priority for the switch or change the link cost metric for the SPB interface connection between two switches.

Multicast Traffic

SPB-M supports two methods for replicating and forwarding multicast traffic (or unknown destination traffic) received from customer equipment: head-end replication and tandem replication.

- **Head-end replication.** Multicast traffic is replicated once for each receiver, encapsulated with the BMAC address, and then sent as a unicast packet to each destination. This method is more suited for networks where there is a low demand for multicast traffic.
- **Tandem replication.** Multicast traffic is replicated only where there is a fork in the SPT and each branch has at least one receiver. Each multicast source bridge in the SPB-M network is the root for a

multicast distribution tree (MDT). A MDT is created per-source per-BVLAN and it is pruned according to whether the SPB node is on the shortest path of a multicast transmitter and receiver. For those MDTs that cross a given Backbone Edge Bridge (BCB), that BCB needs to generate a multicast forwarding table for each such MDT.

Multicast traffic originating from a bridge is encapsulated with a special multicast BMAC DA that identifies the source of the traffic and then forwarded on the tree. Participating bridges that receive the packet will then know the source of the traffic and will use the multicast forwarding information for that source to switch the packet to the appropriate destination.

SPB Services

The SPB-M network topology consists of two layers:

- **The backbone infrastructure (control plane) layer.** ISIS-SPB builds the backbone layer by defining loop-free, shortest path trees (SPTs) through the backbone network (see [“SPB-M Shortest Path Trees” on page 7-8](#) for more information).
- **The services (data plane) layer.** The service layer is based on the Provider Backbone Bridging (PBB) framework as defined in the IEEE 802.1ah standard. SPB-M supports the 802.1ah MAC-in-MAC method for data encapsulation. SPB-M services transport the encapsulated traffic over the ISIS-SPB infrastructure.

The SPB service layer framework is comprised of the following components:

- **Backbone Edge Bridge (BEB).** An OmniSwitch is considered a BEB if the switch is SPB capable and at least one service access point (SAP) and one SPB interface is configured on the switch. The BEB marks the boundary between the customer network and the PBB network (PBBN).
- **Backbone Core Bridge (BCB).** An OmniSwitch is considered a BCB if the switch is SPB capable and no SAPs are configured but at least one SPB interface is configured on the switch to forward encapsulated SPB-M network traffic. Note that the requirement for configuring a BCB is based on whether or not the network topology includes a transit bridge.
- **Service Instance Identifier (I-SID).** Configured only on a BEB, this component identifies a backbone service instance that will tunnel the encapsulated data traffic through the PBBN between BEBs. The I-SID is bound to a BVLAN ID and a Service Manager SPB service ID when the service is created.
- **Access Port.** A port or link aggregate configured as an SPB access port. This type of port is configured on the BEBs and defines the point at which traffic from other provider networks or directly from customer networks enters the PBBN. The access port is also associated with a Layer 2 profile that specifies how to process protocol control frames received on the port
- **Service Access Point (SAP)**—A SAP is a logical service entity (also referred to as a virtual port) that is configured on a BEB to bind an access port to an SPB service ID and specify the type of customer traffic ((untagged, single-tagged, double-tagged, or all) to encapsulate and tunnel through the PBBN.
- **SPB Interface (Network Port)**—A port or link aggregate configured as an SPB interface that resides on either a BEB or a BCB and connects to the backbone network. Network ports carry customer traffic encapsulated in 802.1ah frames and are associated with all BVLANs on the switch. Customer traffic ingressing on a network port is switched to another network port (on BCBs) or to an access port (on BEBs).

Once the ISIS-SPB infrastructure and the SPB service-based architecture is defined, the following service components are dynamically created by the OmniSwitch. No user-configuration is required.

- **Service Distribution Point (SDP)**—An SDP provides a logical point at which customer traffic is directed from one BEB to another BEB. SDPs are used to set up distributed services, which consist of at least one SAP on a local node, one SAP on a remote node, and an SDP binding the service on both nodes.
- **Mesh SDP**—A mesh SDP represents the binding of an SPB service instance to an SDP. The SDP then distributes the service connectivity to other BEBs through the ISIS-SPB shortest path trees.

Sample SPB-M Network Topology

The following diagram provides a sample SPB-M network topology that shows how the SPB-M service and ISIS-SPB backbone layers work together to basically extend (or virtualize) customer traffic across a Provider Backbone Bridge Network (PBBN):

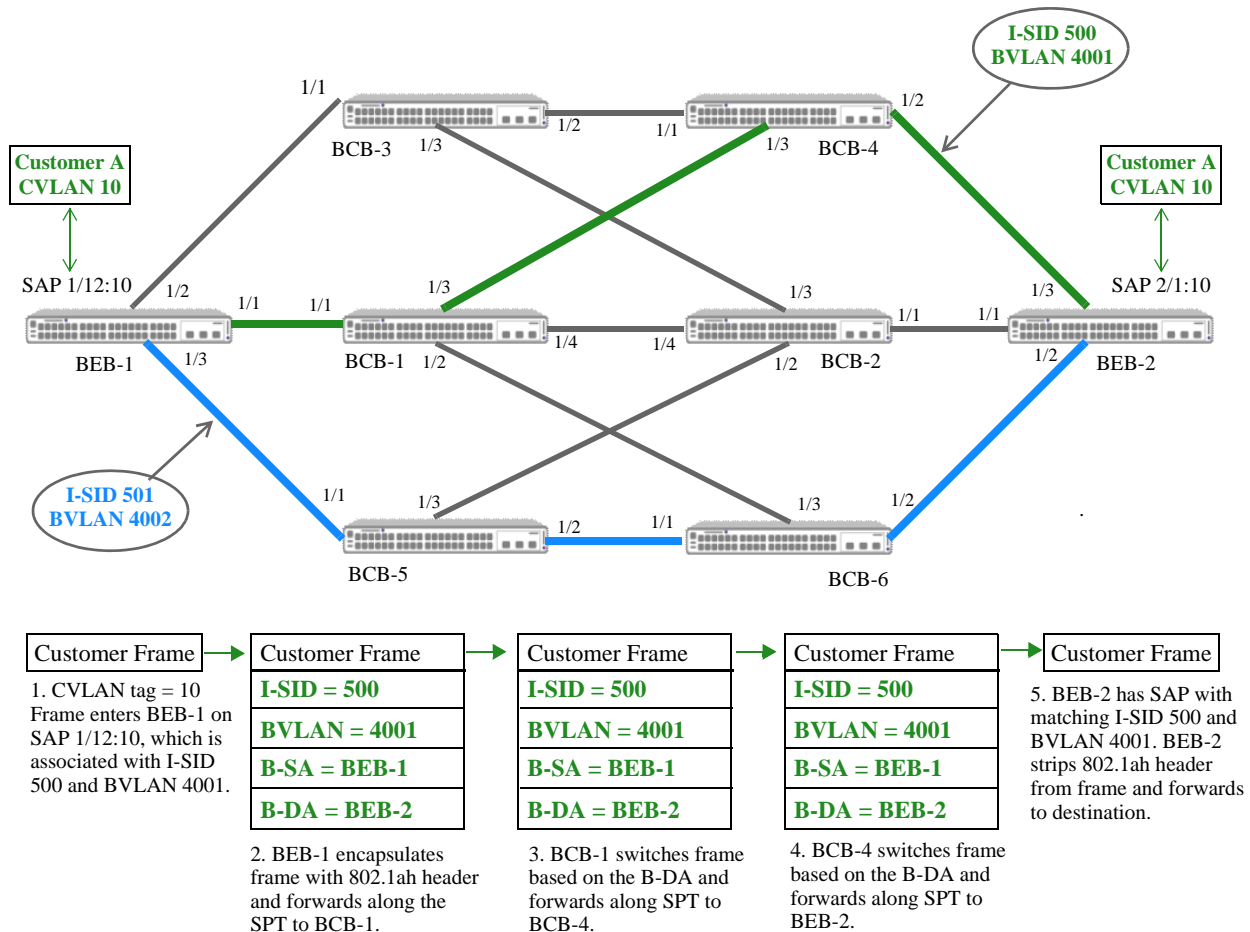

Figure 5: Sample SPB-M Network

In this sample SPB-M topology:

- The packet flow for Customer A frames tagged with VLAN 10 is shown as a typical example. These frames are mapped to an SPB service that represents a binding of I-SID 500 to BVLAN 4001. The path for this binding is shown in green.
- An additional path, shown in blue, is for another SPB service that represents a binding of I-SID 501 to BVLAN 4002. This provides an example of how adding an additional BVLAN and service

configuration to the topology can provide an alternate service path for other traffic from the same customer or traffic from a completely different customer.

- SPB BVLAN 4001 and 4002 are created and assigned to ECT ID 1 and 2, respectively, on every switch (BEBs and BCBs) in the topology. These BVLANs serve as the transport entity on which ISIS-SPB builds the shortest path trees and SPB services tunnel data.
- The switch ports connecting each SPB switch with the next-hop SPB switch are configured as SPB interface ports. This type of port is used to forward ISIS-SPB control packets and serves as a network port for tunneling encapsulated traffic through SPB services.
- The service access points (SAPs) created on BEB-1 and BEB-2 determine which frames from Customer A are accepted on the SAP port, where they are then encapsulated and mapped to the associated service. Other SAPs exist on these switches for the other service path.
- When a frame tagged with VLAN 10 ingresses on port 1/12, the frame is encapsulated in an 802.1ah header. The header specifies the BMAC for BEB-1 as the B-SA, the BMAC for BEB-2 as the B-DA, the SAP I-SID (500), and the SAP BVLAN (4001).
- All other frames ingressing on SAP 1/12:10 that are not tagged with VLAN 10 are dropped, unless there are other SAPs configured for that port that will classify those frames.
- The encapsulated frame is then forwarded along the BVLAN 4001 shortest path tree (SPT) to BEB-2, where the 802.1ah header is stripped off and the frame is forwarded to the appropriate destination port.
- The entire process for encapsulating and tunneling customer frames is the same for frames ingressing on port 2/1 of BEB-2 destined for BEB-1.

How it Works

- There is one instance of ISIS-SPB supported in the backbone topology. This instance is activated once the BVLANs and SPB interfaces are created and the administrative status of ISIS-SPB is enabled for each switch.
- When ISIS-SPB is administratively enabled on each switch, all the configured SPB interfaces start to advertise Hello packets to discover and establish adjacencies with other SPB switches.
- Once adjacencies are established, link state packets (LSPs) are generated with SPB-specific TLVs and shortest path trees from each switch to all other switches are calculated.
- Each SPB switch learns the backbone MAC (BMAC) address and associated BVLAN IDs of every SPB switch in the network and stores that information in a local forwarding database. The BMAC address is the bridge MAC address of the switch and is advertised by ISIS-SPB as the System ID.
- ISIS-SPB then informs Service Manager of the reachability of the BMAC/BVLAN combinations. This information is used to automatically create a service distribution point (SDP) between the same BVLAN on each BEB.
- When ISIS-SPB receives advertisement of a service instance identifier (I-SID) from a remote BEB that matches an I-SID created on the local switch, the SDP (BMAC/BVLAN) of the remote BEB is bound to the I-SID. The binding of a service to an SDP is referred to as a mesh SDP.
- Basically, an SDP is a dynamically created logical entity that distributes service connectivity to other BEBs through the ISIS-SPB shortest path trees. When customer frames are then classified into a specific SAP, the frames are encapsulated and tunneled through the mesh SDP (service/SDP bind) associated with that SAP.

IP over SPBM

The OmniSwitch implementation of SPBM provides L2 VPN capability that bridges L2 customer LAN segments. Customer edge (CE) devices form peers and exchange routing information, as well as perform the necessary IP forwarding. Then the SPBM BEBs bridge the already routed IP traffic across the SPBM backbone.

In addition to L2 VPN, the OmniSwitch also provides an IP over SPBM capability that consolidates the routing functionality of CE devices into the BEB devices. The Virtual Routing and Forwarding (VRF) instances on different BEBs are tied together via backbone I-SIDs across the same SPBM backbone that is used to support Layer 2 VPNs.

The OmniSwitch IP over SPBM solution supports two methods for combining L3 routing and L2 SPBM in the same switch: VPN-Lite and L3 VPN.

VPN-Lite

The VPN-Lite method provides a gateway between a regular SPBM service and a router within the same OmniSwitch chassis. This solution provides a specific advantage in that it allows a single box to represent two tiers in a typical fat-tree network, which is popular in data center deployments.

In addition, a VPN-Lite configuration can act purely as a L3 VPN when configured correctly. In this mode, existing routing protocols can form adjacencies across the SPBM PBB network. To keep it purely a L3 VPN, the administrator makes sure that no SPBM SAPs that can inject bridged flows are allowed to attach to the I-SID designated for the specific VPN.

The VPN-Lite approach uses the SPBM network in the same way a VLAN is used for transporting L3 frames. Each BEB or host can inject frames into the I-SID as needed, and BEBs can decide to bridge or route those frames based on their inner and outer destination MAC address.

L3 VPN

When the L3 VPN method is implemented, the OmniSwitch acts as an access or edge router to multiple VRFs and connects these VRFs across an SPBM PBB network. Each VPN is identified by a local VRF instance on each BEB and globally in the backbone by an I-SID in the PBB header. ISIS-SPB will import and export routes from the local routing protocols running inside their respective VRFs. In essence, ISIS-SPB is creating tunnels between BEBs through which routed frames are sent to reach their target networks.

The OmniSwitch L3 VPN solution is based on the IETF drafts *IP/IPVPN services with IEEE 802.1aq SPB(B) networks* and uses IS-IS TLVs to exchange routes between the BEBs that host the same VPN services. This approach also gives an administrator the ability to build VPNs and extend them over an SPBM core.

IP over SPBM Loopback

Both the VPN-Lite and L3 VPN solutions for routing IP over an SPBM backbone network require a physical loopback port configuration on the BEB. A regular switch port or a static link aggregate can serve as a loopback port. In addition, multiple loopback port pairs are allowed and can be shared between different VRFs.

The loopback configuration consists of one port tagged with an IP interface VLAN that belongs to a single VRF instance connected to another port that is assigned to an SPB SAP, to which the VLAN ID associated with the other loopback port is assigned.

- The loopback port assigned to the IP VLAN is referred to as the L3 VPN router port.

- The loopback port assigned to the SPB SAP is referred to as the L3 VPN access port.
- The VLAN associated with both loopback ports is referred to as the L3 VPN VLAN.
- The IP interface assigned to the VLAN is referred to as the L3 VPN IP interface.

The loopback cable connects a VRF to an SPB SAP and can carry traffic from different VRFs tagged with different L3 VPN VLANs. The following diagram shows a logical depiction of the IP over SPB loopback configuration:

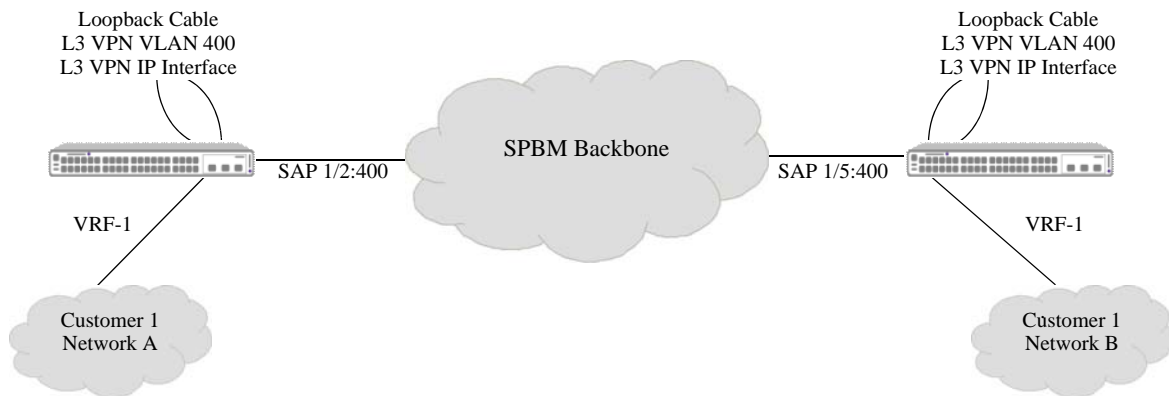

Figure 7: IP over SPB Loopback

How it Works

This section describes the VPN-Lite and L3 VPN control and data plane operations in an IP over SPB network configuration. Although both approaches require the L3 VPN loopback configuration, they differ in how routing protocol control packets are exchanged and processed to support IP over SPB.

VPN-Lite Control Plane Operations

When routing protocols or static routes are running on the L3 VPN IP interface of the loopback configuration, the interface can exchange IP routes with other L3 VPN IP interfaces that are running the same routing protocols and are associated with the same I-SID. By exchanging routes with other loopback IP interfaces, VRFs on different BEBs can learn remote networks from each other.

In this scenario, the routing protocol control packets sent from the L3 VPN IP interfaces travel through the L3 VPN router port, enter the L3 VPN access port, are distributed into different services by SAPs and are carried on SDPs into the SPBM backbone. The control packets received from the SPBM backbone travel from SDPs to the VRF following the same process but in reverse.

L3 VPN Control Plane Operations

The ISIS-SPB support of the IPVPN TLV and IPv4 sub-TLV provides a different method for exchanging L3 routes between VRFs. Instead of running routing protocols on the L3 VPN IP interfaces, IP routes are imported into ISIS-SPB from VRFs. ISIS-SPB then carries these routes in the TLVs through the SPBM cloud to other SPBM BEBs. When ISIS-SPB receives IPVPN TLVs from the cloud, ISIS-SPB will export the routes to the appropriate VRFs.

The L3 VPN approach implements the importing and exporting of routes between ISIS-SPB and VRF instances and the transport of these routes using the supported TLVs. The administrator does not configure routing protocols on the L3 VPN IP interface. Implementing the L3 VPN approach requires careful consideration to avoid routing loops.

VPN-Lite and L3 VPN Data Plane Operations

Data is moved in the same manner for both VPN-Lite and L3 VPN traffic, and the existing data plane forwarding mechanisms for SPB and IP are used without modification:

- A L3 VPN IP interface serves as an IP gateway to access remote networks. The network administrator has to ensure the IP subnet reachability of the L3 VPN addresses on the same SPBM I-SID.
- L3 VPN IP interfaces use dynamic ARP to learn the MAC addresses of other L3 VPN IP interfaces and provide next-hop forwarding information to the switch.
- IP data plane packets travel the same path as VPN-Lite control packets (see [“VPN-Lite Control Plane Operations” on page 7-16](#) for more information).
- Data in the SPBM cloud is encapsulated into the Provider Backbone Bridge (PBB) format (see [“SPB Services” on page 7-12](#) for more information).

For more information and configuration examples, see [“Configuring IP over SPB” on page 7-46](#) and [“IP over SPB Configuration Examples” on page 7-47](#).

Interaction With Other Features

This section contains important information about Shortest Path Bridging MAC (SPB-M) interaction with other OmniSwitch features. Refer to the specific chapter for each feature to get more detailed information about how to configure and use the feature.

Backbone VLANs (VLAN Manager)

VLAN Manager CLI commands are used to create an SPB backbone VLAN (BVLAN). Although a BVLAN is created in a similar manner as a standard VLAN, BVLANS differ from standard VLANs as follows:

- No Spanning Tree control—the Spanning Tree protocol is automatically disabled on each BVLAN and all ports associated with each BVLAN will remain in a forwarding state. However, Spanning Tree can remain operational on other types of VLANs.
- No source MAC address learning—normal hardware learning is disabled on BVLANS. Instead, the forwarding database (FDB) is populated by the ISIS-SPB protocol.
- There is no flooding of unknown destination or multicast frames.
- Ingress filtering based on the source MAC address—frames received on ports that do not have an incoming source MAC address pre-programmed by ISIS-SPB are discarded.
- IP interfaces are not supported on BVLANS.

Application Monitoring and Enforcement

The OmniSwitch statistics collection capability is shared, which means that only one feature can use this capability at any given time. By default, this capability is used by the Service Manager application to provide statistics collection for SPB services. This means that statistics gathering is not available for the Application Monitoring and Enforcement (AppMon) feature.

To make the statistics collection functionality available for the AppMon feature, disable the Service Manager statistics mechanism using the `service stats` command. For example:

```
-> service stats disable
```

When disabled, statistics collection is no longer available for Service Manager to provide this function for SPB services. To restore statistics collection functionality for SPB services, if necessary, use the following command:

```
-> service stats enable
```

When enabled, statistics collection is no longer available for AppMon and only available for SPB services.

Link Aggregation

- Both static and dynamic link aggregates are configurable as SPB-M service access ports and as SPB-M network interfaces.
- Note that a link aggregate must consist of all access ports or all network ports. SPB-M functionality is not supported on link aggregates that consist of a mixture of SPB-M ports and standard switch ports.

OAM

- OAM support per the IEEE 802.1ah standard for Provider Backbone Bridging (PBB) is applied at the customer VLAN (CVLAN) and the backbone VLAN (BVLAN) level. Support at the service instance (I-SID) level is not available.
- The OmniSwitch proprietary Layer 2 ping and traceroute features are available to troubleshoot CVLAN and BVLAN domains, including an I-SID check.

Quality of Service (QoS)

- The priority assignment of a user frame is determined at an access point. A Service Access Point (SAP) on an SPB access port can be configured as trusted or un-trusted. If a SAP is configured as trusted, then internal priority for ingress traffic on that SAP is derived from tagged or NULL tagged ingress packet priority or from default port priority if ingress packet is untagged. If a SAP is untrusted then internal priority can be configured by the user.
- QoS performs the following actions on ports configured as access ports:
 - Access ports are automatically trusted and the default classification is set to 802.1p.
 - The trust status and classification are not user-configurable on access ports.
 - All QoS CLI configuration is blocked on access ports. This includes physical ports and ports that are members of a link aggregate.
 - Untagged L2 control packets (such as BPDU, GVRP, AMAP) are always tunneled (if enabled) through the SPB domain with the default EXP bits set at 7, so that they can arrive at the destination at the highest priority of 7. Trusted/untrusted SAPs configured on access ports will not affect the priority assignment for Layer 2 control packets.
- QoS priority (802.1p) is applied as follows to trusted and untrusted SAPs:

SAP Configuration	Allowed Configuration	
Tagged (VLAN 1–4094)	Trusted	Tagged traffic priority derived from tags.
	Untrusted	Tagged traffic priority configured by user.
QinQ (outer VLAN 1–4094)	Trusted	Tagged traffic priority derived from outer tags.
	Untrusted	Tagged traffic priority configured by user.
Wild Card	Trusted	Tagged traffic priority derived from tags. Untagged traffic Port default (PRI 0).
	Untrusted	Tagged/ traffic priority configured by user
Untagged	Trusted	Untagged Traffic Port default (PRI 0)
	Untrusted	Priority configured by user.

- By default, a SAP is trusted with best effort priority (0)
- A SAP can be dynamically changed to trusted/untrusted without admin down the sap
- A SAP priority may only be set when a SAP is untrusted.
- When a SAP is changed from untrusted to trusted, any previously assigned priority is reset with best effort priority (0).
- A trusted SAP that defines a double-tagged encapsulation (QinQ) will use the outer VLAN tag to determine the priority of the frame.

- Priority handling at the edge and core components of an SPB-M topology:
 - On an ingress Backbone Edge Bridge (BEB), a frame is classified to a SAP. The internal priority is determined based on the QoS settings of the SAP (for example, trusted vs. untrusted, default priority). This internal priority is mapped to the backbone VLAN (BVLAN) tag of the tunnel encapsulation.
 - The Backbone Core Bridge (BCB) acts as a Layer 2 device that switches the frame across ingress to egress ports in the BVLAN domain. The BVLAN tag is used to determine the internal priority queue on the egress port where the frame is enqueued.
 - On an egress BEB, the internal priority is determined from the BVLAN tag. The frame is de-encapsulated and enqueued to the egress queue(s) of the access port(s) based on this internal priority.

Universal Network Profiles (UNP)

Integration with Virtual Machine Network Profiles (vNPs) to support device discovery and mobility. The UNP feature supports two types of profiles: VLAN and service. A service profile can be configured to classify traffic for SPB tunneling.

The OmniSwitch supports both a VLAN and service domain for traffic classification.

- The VLAN domain is identified by a VLAN ID. In the VLAN domain, each VLAN is accessed through a physical port. Each physical port can have more than one VLAN attached. UNP VLAN classification associates a MAC address to a specific VLAN on a physical UNP bridge port.
- The service domain is identified by a Shortest Path Bridging (SPB) service instance identifier (I-SID), which is associated with a Service Manager service ID to represent a VFI.

In the service domain, each VFI is accessed through a virtual port, referred to as a Service Access Point (SAP). UNP service classification associates a MAC address to a SAP.

Dynamic Service Access Points

A UNP service profile can trigger the dynamic creation of a SAP when traffic received on a UNP access port is classified and assigned to that profile. If the service (VXLAN or SPB) that the SAP is associated with does not exist, the service is also dynamically created.

Allowing incoming traffic to trigger dynamic SAP creation reduces the amount of manual configuration required. In addition, no other protocols are required on the switch or host device to support this functionality.

VRF

IP over SPB uses Virtual Routing Forwarding (VRF) instances to exchange routes with I-SIDs. This is accomplished via the Global Route Manager (GRM). VRF routes are exported to the GRM table and imported into I-SIDs; I-SID routes are exported to the GRM table and imported into VRFs.

- A binding is created between a VRF and the I-SIDs to identify which I-SIDs will export routes to the GRM for the specified VRF (see [“Configuring IP over SPB” on page 7-46](#) for more information).
- The **ip import** command has an optional **isid** parameter that notifies GRM to import the routes from the specified I-SID into the requesting VRF.

Quick Steps for Configuring SPB-M

This section provides a quick tutorial for configuring the SPB-M network backbone (control plane) and the service encapsulation path (data plane). The Command Line Interface (CLI) commands provided in this section are used to configure the [“Sample SPB-M Network Topology”](#) on page 7-13.

Quick Steps for Configuring the SPB-M Backbone

The following quick steps are used on each switch in the SPB-M backbone that will participate in the [“Sample SPB-M Network Topology”](#) on page 7-13. This includes both edge and transit (core) switches.

- 1 Use the **system name** command to assign a unique system name to each SPB switch in the domain.

```
-> system name BEB-1
-> system name BEB-2
-> system name BCB-1
-> system name BCB-2
-> system name BCB-3
-> system name BCB-4
-> system name BCB-5
-> system name BCB-6
```

- 2 Use the **spb bvlan** command to create BVLANS 4001 and 4002 on each switch (edge and core switches) that will participate in the SPB-M topology.

```
-> spb bvlan 4001
-> spb bvlan 4002
```

- 3 Use the **spb isis bvlan ect-id** command to change the equal cost tree (ECT) algorithm ID for the specified BVLAN, as necessary, to make sure that the same ECT ID is assigned to the same BVLAN ID on each switch in the SPB-M topology.

```
-> spb isis bvlan 4001 ect-id 1
-> spb isis bvlan 4002 ect-id 2
```

- 4 Use the **spb isis control-bvlan** command to designate one of the BVLANS on each SPB switch as the control BVLAN for the SPB instance. The control BVLAN is used to exchange ISIS-SPB control packets with neighboring SPB switches.

```
-> spb isis control-bvlan 4001
```

- 5 Use the **spb isis interface** command to configure a port or link aggregate as an SPB interface. This type of interface sends PDUs to detect neighboring SPB switches and form adjacencies and also serves as a network port that is used to carry encapsulated service traffic through the SPB-M backbone network.

```
-> spb isis interface port 1/1-3
-> spb isis interface port 1/1-4
```

- 6 Use the **spb isis admin-state** command to enable the SPB instance for the switch. Enabling ISIS-SPB on the switch triggers the transmission of hello packets from the SPB interfaces, which starts the process of defining the SPB infrastructure and calculating the shortest path trees (SPTs) through the topology.

```
-> spb isis admin-state enable
```

Quick Steps for Configuring SPB Services

The following quick steps use the OmniSwitch Service Manager commands to configure the logical entities that comprise the SPB services in the “[Sample SPB-M Network Topology](#)” on page 7-13.

1 Use the **service access** command to configure a port or link aggregate on which customer traffic is received as an SPB service access port.

```
-> service access port 1/1
-> service access port 2/1
```

2 Use the **service spb** command to create an SPB service and associate that service with a backbone service instance identifier (I-SID) and BVLAN.

```
-> service spb 1 isid 500 bvlan 4001 admin-state enable
-> service spb 2 isid 501 bvlan 4002 admin-state enable
```

3 Use the **service spb sap** command to create a service access point (SAP) by associating an SPB service with SAP ID. A SAP ID is comprised of a port or link aggregate and an encapsulation value that identifies the customer traffic to associate with the service.

```
-> service spb 1 sap port 1/12:10 admin-state enable
-> service spb 1 sap port 2/1:10 admin-state enable
-> service spb 2 sap port 1/12:0 admin-state enable
-> service spb 2 sap port 1/12:all admin-state enable
```

In this example, SAPs 1/12:10 and 2/1:10 map traffic ingressing on these SAPs that has an outer tag (customer VLAN tag) equal to 10 to the service associated with the SAP. In this case, SPB service 1 (ISID=500, BVLAN=4001). SAPs 1/12:all and 2/1:all map all tagged and untagged traffic ingressing on these SAPs to the service associated with the SAP.

Sample Command Configuration

This section provides the sequence of commands used on each switch to configure the “[Sample SPB-M Network Topology](#)” on page 7-13. Note that the SPB-M backbone is configured on every switch first, then the SPB-M service architecture is configured second. Following this order of configuration is highly recommended to ensure proper switch participation in ISIS-SPB adjacencies and shortest path tree calculations.

SPB-M Backbone Commands

The **system name** and Shortest Path Bridging (**spb**) commands are used to configure the SPB-M backbone infrastructure for the sample topology, as shown:

BEB-1	BEB-2	BCB-1
-> system name BEB-1	-> system name BEB-2	-> system name BCB-1
-> spb bvlan 4001	-> spb bvlan 4001	-> spb bvlan 4001
-> spb bvlan 4002	-> spb bvlan 4002	-> spb bvlan 4002
-> spb isis bvlan 4001 ect-id 1	-> spb isis bvlan 4001 ect-id 1	-> spb isis bvlan 4001 ect-id 1
-> spb isis bvlan 4002 ect-id 2	-> spb isis bvlan 4002 ect-id 2	-> spb isis bvlan 4002 ect-id 2
-> spb isis control-bvlan 4001	-> spb isis control-bvlan 4001	-> spb isis control-bvlan 4001
-> spb interface port 1/1-3	-> spb interface port 1/1-3	-> spb interface port 1/1-4
-> spb isis admin-state enable	-> spb isis admin-state enable	-> spb isis admin-state enable

BCB-2

```
-> system name BCB-2
-> spb bvlan 4001
-> spb bvlan 4002
-> spb isis bvlan 4001 ect-id 1
-> spb isis bvlan 4002 ect-id 2
-> spb isis control-bvlan 4001
-> spb interface port 1/1-4
-> spb isis admin-state enable
```

BCB-3

```
-> system name BCB-3
-> spb bvlan 4001
-> spb bvlan 4002
-> spb isis bvlan 4001 ect-id 1
-> spb isis bvlan 4002 ect-id 2
-> spb isis control-bvlan 4001
-> spb interface port 1/1-3
-> spb isis admin-state enable
```

BCB-4

```
-> system name BCB-4
-> spb bvlan 4001
-> spb bvlan 4002
-> spb isis bvlan 4001 ect-id 1
-> spb isis bvlan 4002 ect-id 2
-> spb isis control-bvlan 4001
-> spb interface port 1/1-3
-> spb isis admin-state enable
```

BCB-5

```
-> system name BCB-5
-> spb bvlan 4001
-> spb bvlan 4002
-> spb isis bvlan 4001 ect-id 1
-> spb isis bvlan 4002 ect-id 2
-> spb isis control-bvlan 4001
-> spb interface port 1/1-3
-> spb isis admin-state enable
```

BCB-6

```
-> system name BCB-6
-> spb bvlan 4001
-> spb bvlan 4002
-> spb isis bvlan 4001 ect-id 1
-> spb isis bvlan 4002 ect-id 2
-> spb isis control-bvlan 4001
-> spb interface port 1/1-3
-> spb isis admin-state enable
```

SPB-M Service Commands

The Service Manager (**service**) commands are used to build the SPB-M services architecture for the sample topology, as shown. Note that services are only configured on designated BEB switches.

BEB-1

```
-> service access port 1/12
-> service spb 1 isid 500 bvlan 4001
-> service spb 2 isid 501 bvlan 4002
-> service spb 1 sap port 1/12:10 admin-state enable
-> service spb 2 sap port 1/12:0 admin-state enable
-> service spb 2 sap port 1/12:all admin-state enable
```

BEB-2

```
-> service access port 1/12
-> service spb 1 isid 500 bvlan 4001
-> service spb 2 isid 501 bvlan 4002
-> service spb 1 sap 1/12:10 admin-state enable
-> service spb 2 sap 1/12:0 admin-state enable
-> service spb 2 sap 1/12:all admin-state enable
```

Configuring SPB-M

Configuring the SPB-M backbone and service layers requires several steps. These steps are outlined here and further described throughout this section. For a brief tutorial on configuring SPB-M, see [“Quick Steps for Configuring SPB-M”](#) on page 7-21.

Configure the SPB-M Backbone (ISIS-SPB)

Only switches that are SPB capable can participate in the SPB-M network topology. The following configuration steps are required to make an OmniSwitch an SPB-capable node:

1 Create a BVLAN. The BVLAN provides the foundation of the SPB-M infrastructure. A BVLAN is associated with an equal cost tree (ECT) algorithm ID and an SPB service instance ID that is used to carry customer traffic through the backbone network. See [“Backbone VLANs”](#) on page 7-25.

2 Configure SPB interfaces. An SPB interface is associated with each BVLAN that is configured on the switch. At the ISIS-SPB level, this type of interface sends and received ISIS Hello packets and link state PDU (LSP) to discover adjacent SPB switches and calculate the shortest path trees through the SPB-M network topology. At the services level, the SPB interfaces serve as network ports that are used to carry encapsulated customer traffic through the network. See [“Configuring SPB Interfaces”](#) on page 7-28.

3 Configure global ISIS-SPB parameters. In addition to enabling/disabling the ISIS-SPB instance for the switch, global configuration includes settings such as a system name for the switch, global bridge parameters, and various wait time intervals. When ISIS-SPB is enabled for the switch, default settings for these global bridge parameters and wait time intervals are active. It is only necessary to change these values if the default settings are not sufficient. See [“Configuring Global ISIS-SPB Parameters”](#) on page 7-30.

For more information about SPB-M commands, see [Chapter 8, “Shortest Path Bridging Commands,”](#) in the *OmniSwitch AOS Release 8 CLI Reference Guide*.

Configure SPB-M Services

The OmniSwitch Service Manager application is used to configure the services layer of the SPB-M network topology. A service is defined by a specific set of logical entities that are configured only on the backbone edge bridges (BEBs) of the network. the following configuration steps are required to define the service-based architecture for an SPB-M network:

1 Create an SPB-M service. A Service Manager service ID is associated with a BVLAN, a backbone service instance identifier (I-SID), and a service access point (SAP) to identify the customer traffic that the service will tunnel through the provider network. See [“Creating an SPB Service”](#) on page 7-36.

2 Configure access (customer-facing) ports. One or more access ports are associated with a service access point (SAP) to identify to the service which ports will receive customer traffic that the service will process for tunneling through the provider network. When an access port is associated with a SAP, the SAP parameter attributes are applied to traffic received on the access port. See [“Configuring Service Access Ports”](#) on page 7-40.

3 Define access port profile attributes. A default Layer 2 profile is automatically assigned to an access port at the time the port is configured as an access port. This profile determines how control frames received on the port are processed. It is only necessary to configure a Layer 2 profile if the default attribute values are not sufficient. See [“Configuring Layer 2 Profiles for Access Ports”](#) on page 7-40.

4 Configure an SPB service access point (SAP). A SAP binds an SPB service to an access (customer-facing) port and defines which customer traffic to tunnel through the service. Each SAP is associated to one service name, but a single service can have multiple SAPs to which it is associated. See [“Verifying the SPB Service Configuration” on page 7-38.](#)

For more information about Service Manager commands, see [Chapter 47, “Service Manager Commands,”](#) in the *OmniSwitch AOS Release 8 CLI Reference Guide*.

SPB Configuration Guidelines

Configuring an SPB-M network topology involves setting up two layers of functionality: the ISIS-SPB backbone infrastructure and the Provider Backbone Bridge (802.1ah) services layer for MAC-in-MAC encapsulation. Review the guidelines in this section before attempting to configure the various components of the SPB-M infrastructure and services.

ISIS-SPB

This implementation of the ISIS-SPB protocol supports only a single topology with a multi-topology identifier (MT-ID) of zero.

- The ISIS-SPB protocol instance is independent of IP IS-IS, or other network layer protocol identifiers (NLPIDs) riding in the same IS-IS implementation. However, ISIS-SPB and IP IS-IS can coexist on the same switch.
- ISIS-SPB interfaces, link state packet databases (LSPDB), and forwarding information are all created and maintained within the single ISIS-SPB instance.
- IS-IS Level 1 point-to-point adjacencies are supported; Level 2 is not supported at this time.
- SPB interfaces are associated with a link metric cost that is configurable, thus providing the ability to change the logical topology created by the ISIS-SPB instance. However, if different metric values are configured on each side of a link, ISIS-SPB will choose the higher-valued one as the metric to use for both sides. This is necessary to enforce the symmetry of SPT calculations in both directions across the link.
- Enabling SPB for the switch automatically triggers the transmission of Hello packets from the SPB interfaces, thus starting the process of discovery and forming adjacencies to build shortest path trees.

Backbone VLANs

- The BVLAN configuration must be the same on each SPB switch within the PBB network. For example, if BVLAN 10 with an ECT ID of 1 is configured on one switch, then BVLAN 10 with an ECT ID of 1 must exist on all other SPB bridges in the network to ensure proper calculation of the ISIS-SPB shortest path trees through the backbone.
- If more than one BVLAN is needed, configure each BVLAN with a different ECT algorithm ID. For example, if two BVLANs (BVLAN 4001 and BVLAN 4002) are needed for a specific SPB-M topology, then create BVLAN 4001 with ECT ID 1 and BVLAN 4002 with ECT ID 2 on each switch that is going to participate in the topology.

Note. When adding another BVLAN to an existing SPB-M topology instance, create the new BVLAN and its associated ECT ID on every switch first, then configure the SPB service association for the BVLAN. Creating SPB services before the BVLAN configuration is complete on all switches can cause problems with forming adjacencies or may even cause an SPB switch to drop existing adjacencies.

- In most cases one BVLAN is sufficient for virtualizing traffic through the network backbone. However, configuring more than one BVLAN provides alternate routes for tunneling customer traffic. This can also provide a form of load balancing by distributing traffic over different BVLAN segments.
- All encapsulated traffic within the BVLAN domain is unicast with a resolved source and destination BMAC addresses. Frames received on BVLAN ports that do not have an incoming source MAC address pre-programmed by ISIS-SPB are discarded.

Configuring BVLANS

The SPB-M backbone VLAN (BVLAN) provides the foundation on which ISIS-SPB shortest path trees are built and SPB-M services tunnel encapsulated customer data through the Provider Backbone Bridge network (PBBN). Configuring a BVLAN on a switch is also the first step in setting up the ISIS-SPB infrastructure and in making an OmniSwitch an SPB-capable node.

Note. The BVLAN configuration must be the same on each OmniSwitch that is going to participate in the SPB-M network topology. So if BVLAN 4001 is created on one switch, then BVLAN 4001 must be created on all other switches in the SPB-M network.

To create a BVLAN, use the **spb bvlan** command with the optional **name** parameter. For example:

```
-> spb bvlan 4001 name spb-4001
```

If the **name** parameter is not specified with this command, the VLAN ID is used for the name by default. For example, the following command creates BVLAN 4001 with “VLAN 4001” as the name:

```
-> spb bvlan 4001
```

To remove a BVLAN, use the **no** form of the **spb bvlan** command. For example:

```
-> no spb bvlan 4001
```

Assigning the Equal Cost Tree ID

ISIS-SPB calculations may result in multiple paths of equal costs. The Equal Cost Tree (ECT) ID specifies a tie-breaking algorithm that is used when ISIS-SPB is calculating a set of shortest path trees from one switch to all other switches in the SPB domain. When a BVLAN is created, an ECT ID is automatically assigned to the BVLAN. If it is the first BVLAN created on the switch, ECT ID 1 is assigned, otherwise the next available ID number is used.

Each BVLAN created must be duplicated on all other participating switches in the SPB-M network and must use the same ECT ID number for that BVLAN on each switch. A BVLAN created on one switch may not be automatically assigned the same ECT ID on another switch. As a result, it may be necessary to modify the ECT ID number using the **spb isis bvlan ect-id** command. For example:

```
-> spb isis bvlan 4002 ect-id 2
```

Note. When adding another BVLAN to an existing SPB-M topology instance, create the new BVLAN and its associated ECT ID on every switch first, then configure the SPB service association for the BVLAN. Creating SPB services before the BVLAN configuration is complete on all switches can cause problems with forming adjacencies or may even cause an SPB switch to drop existing adjacencies.

Configuring the Control BVLAN

One of the BVLANs configured on each switch serves as the control BVLAN for the ISIS-SPB instance. The control BVLAN exchanges ISIS-SPB control packets with neighboring SPB switches on behalf of all BVLANs configured on the local switch. The control packets are tagged with the control BVLAN ID.

By default, the first BVLAN created (or if there is only one), is the control BVLAN. To designate a different BVLAN as the control BVLAN, use the **spb isis control-bvlan** command. For example:

```
-> spb isis control-bvlan 4002
```

A control BVLAN also carries regular encapsulated SPB domain traffic in addition to ISIS-SPB control packets. In other words, a VLAN can serve as both a regular BVLAN and a control BVLAN at the same time.

Configuring the Tandem Multicast Mode

The tandem multicast mode (*,G) or (S,G) of a BVLAN is applied only to SPB services associated with the BVLAN that are using tandem replication for multicast traffic. When a BVLAN is created, the (S,G) tandem multicast mode is applied by default.

To change the tandem multicast mode for a BVLAN, use the **spb isis bvlan tandem-multicast-mode** command and specify either **gmode** (*,G) or **sgmode** (S,G). For example:

```
-> spb isis bvlan 4001 tandem-multicast-mode sgmode
-> spb isis bvlan 4002 tandem-multicast-mode gmode
```

Verifying the BVLAN Configuration

To view the BVLAN configuration for the switch, use the **show spb isis bvlans** command. For example:

```
-> show spb isis bvlans
```

```
SPB ISIS BVLANS:
```

BVLAN	ECT-algorithm	In Use	Services mapped	Num ISIDS	Tandem Multicast	Root Bridge (Name : MAC Address)
4001	00-80-c2-01	YES	YES	52	SGMODE	
4002	00-80-c2-02	YES	YES	51	SGMODE	
4003	00-80-c2-03	YES	YES	52	SGMODE	
4004	00-80-c2-04	YES	YES	51	SGMODE	

```
BVLANS:          4
```

The BVLAN is a special type of VLAN that is created and maintained by VLAN Manager. As a result, it also appears in the VLAN Manager **show** command displays. For example, in the following **show vlan** output display, VLANs 4001 through 4004 are included and “spb” appears in the “type” column:

```
-> show vlan
```

vlan	type	admin	oper	ip	mtu	name
1	std	Dis	Dis	Dis	1500	VLAN 1
1000	std	Ena	Ena	Ena	1500	VLAN 1000
4001	spb	Ena	Ena	Dis	1524	VLAN 4001
4002	spb	Ena	Ena	Dis	1524	VLAN 4002
4003	spb	Ena	Ena	Dis	1524	VLAN 4003
4004	spb	Ena	Ena	Dis	1524	VLAN 4004
4094	mcm	Ena	Dis	Dis	9198	MCM IPC

To view configuration information for an individual BVLAN, use the **show vlan** command and specify the BVLAN ID. For example:

```
-> show vlan 4001
Name                : VLAN 4001,
Type                : Backbone vlan,
Administrative State : enabled,
Operational State   : disabled,
IP Router Port      : disabled,
IP MTU              : 1524
```

Configuring SPB Interfaces

A port or link aggregate is configurable as an SPB interface. Each switch in the SPB-M topology should have at least one SPB interface configured. The SPB interface serves more than one purpose:

- Advertises IS-IS Hello packets to discover SPB neighbors and establish adjacencies.
- After adjacencies are established, exchanges link state packets (LSPs) with SPB neighbors to build a local LSP database (LSPDB). A switch's adjacencies are reflected in the contents of its link state packets. This relationship between adjacencies and link state allows the protocol to detect downed routers in a timely fashion.
- Serves as a network port by forwarding encapsulated SPB service traffic on backbone VLANs (BVLANS) through the SPB-M Provider Backbone Bridge (PBB) network.

To configure a port or link aggregate as SPB interface, use the **spb isis interface** command. For example:

```
-> spb isis interface port 1/10
-> spb isis interface linkagg 5
```

When a port is converted to an SPB interface, the interface is automatically assigned to all existing BVLANS. There is one ISIS-SPB instance per switch, and each BVLAN and SPB interface are associated with that instance. However, it is also possible to tag SPB interfaces to carry traffic for standard VLANs.

The **spb isis interface** command is also used to optionally configure the following parameter values:

- **admin-state**—Administratively enables or disables the SPB interface. By default, the interface is enabled when the SPB interface is created.
- **hello-interval**—Specifies the amount of time, in seconds, to wait between each transmission of a hello packet from this interface. By default, the hello time interval is set to nine seconds.
- **hello-multiplier**—Specifies an integer value that is multiplied by the hello interval time to determine the amount of time, in seconds, a receiving bridge holds onto the hello packets transmitted from this interface. By default, the hello multiplier is set to three.
- **metric**—An integer value that specifies the link cost to reach the destination backbone MAC (BMAC). By default, the link cost is set to ten. Changing the link metric value provides a method for changing the logical topology as calculated by ISIS-SPB.

The following command examples change the default hello and metric values for the SPB interface:

```
-> spb isis interface port 4/7 hello-interval 60
-> spb isis interface linkagg 3 hello-multiplier 10
-> spb isis interface port 2/1 metric 100
-> spb isis interface linkagg 5 hello-interval 20 hello-multiplier 5 metric 200
```

Verifying the SPB Interface Configuration

To view the SPB interface configuration for the switch, use the `show spb isis interface` command. For example:

```
-> show spb isis interface
```

```
SPB ISIS Interfaces:
```

Interface	Level	CircID	Oper state	Admin state	Link Metric	Hello Intvl	Hello Mult
1/1	L1	1	UP	UP	10	9	3
1/2	L1	2	UP	UP	10	9	3
1/3	L1	3	UP	UP	10	9	3
1/4	L1	4	DOWN	UP	10	9	3
1/5	L1	5	DOWN	UP	10	9	3
1/6	L1	6	DOWN	UP	22	9	3
1/7	L1	7	DOWN	UP	10	9	3

```
Interfaces : 7
```

Configuring Global ISIS-SPB Parameters

This section describes the global configuration for the ISIS-SPB instance, which includes the following:

- “Configuring the System Name” on page 7-31.
- “Configuring the SPB Bridge Priority” on page 7-31.
- “Configuring the ISIS-SPB Area Address” on page 7-31.
- “Configuring the Shortest Path Source ID” on page 7-31.
- “Configuring the Control MAC Address” on page 7-31.
- “Configuring the Shortest Path First Wait Time” on page 7-32.
- “Configuring the Link State Packet Wait Time” on page 7-33.
- “Configuring the Overload State” on page 7-34.
- “Configuring Redundant Switches for Graceful Restart” on page 7-35.
- “Enabling/Disabling ISIS-SPB” on page 7-35.

To verify the global SPB configuration for the switch, use the **show spb isis info** command. For example:

```
-> show spb isis info
SPB ISIS Bridge Info:
  System Id           = e8e7.3233.1831,
  System Hostname     = BEB-1,
  SPSourceID         = 03-18-31,
  SPBM System Mode   = auto,
  BridgePriority      = 32768 (0x8000),
  MT ID              = 0,
  Control BVLAN      = 4001,
  Area Address        = 0.0.0,
  Level Capability    = L1,
  Admin State         = UP,
  LSDB Overload      = Disabled,
  Last Enabled        = Thu Aug  2 22:43:19 2012,
  Last SPF            = Fri Aug  3 18:15:51 2012,
  SPF Wait            = Max: 1000 ms, Initial: 100 ms, Second: 300 ms,
  LSP Lifetime        = 1200,
  LSP Wait            = Max: 1000 ms, Initial: 0 ms, Second: 300 ms,
  Graceful Restart    = Disabled,
  GR helper-mode      = Disabled,
  # of L1 LSPs        = 8
  Control Address     = 01:80:C2:00:00:14 (AllL1)
```

Configuring the System Name

Configuring a system name is required on each switch that is going to participate in the SPB-M topology. To configure a system name for the switch, use the **system name** command. For example:

```
-> system name BEB-1
```

ISIS-SPB advertises the system name to identify the switch to other SPB peer switches.

Configuring the SPB Bridge Priority

A bridge is ranked within the SPB topology by its bridge ID (an eight byte hex number). The bridge priority value makes up the upper two bytes of the eight-byte SPB bridge ID. The lower six bytes of the Bridge ID contain the system ID, which is the dedicated bridge MAC address of the SPB bridge.

The bridge priority is used in shortest path tree calculations. The lower the priority value, the higher the priority. Setting a different bridge priority value on different SPB bridges will override the system ID significance during the shortest path tree (SPT) calculation.

By default, all SPB switches are assigned a priority value of 32768. To change the bridge priority value for a switch, use the **spb isis bridge-priority** command. For example:

```
-> spb isis bridge-priority 25590
```

Configuring the ISIS-SPB Area Address

By default, the IS-IS area address for the ISIS-SPB instance is set to 0.0.0, which is typically sufficient for this implementation of SPB-M. Both ISIS-SPB and ISIS-IP instances may coexist on the same switch as long as they don't use the same area address.

If changing the area address is necessary, use the **spb isis area-address** command. For example:

```
-> spb isis area-address 1.1.1
```

Note. Each switch that is going to participate in the SPB topology must use the same area address and must use an address that is different from the ISIS-IP area address.

Configuring the Shortest Path Source ID

The shortest path (SP) source ID, identifies the source of multicast frames and is relevant only in multicast tandem replication mode. By default, the last three least significant bytes of the system ID (local bridge MAC address) is used for the source ID value.

To change the source ID value, use the **spb isis source-id** command. For example:

```
-> spb isis source-id 07-0b-d3
```

To set the source ID back to the default value, use the **spb isis source-id** command with the **auto** parameter. For example:

```
-> spb isis source-id auto
```

Configuring the Control MAC Address

The control MAC address is the destination MAC address used for ISIS-SPB control packets. Changing this address can enhance interoperability between an SPB-capable OmniSwitch and other third-party SPB-capable devices.

By default, the control MAC address is set to 01:80:C2:00:00:14 (all Level 1 Intermediate Systems). The following parameters are used with the **spb isis control-address** command to change the control MAC address:

- **alll1**—All Level 1 Intermediate Systems (01:80:C2:00:00:14).
- **alll2**—All Level 2 Intermediate Systems (01:80:C2:00:00:15).
- **allis**—All Intermediate Systems (09:00:2B:00:00:05).

For example, the following command changes the default control MAC address from AllL1 to AllL2:

```
-> spb isis control-address alll2
```

Configuring the Shortest Path First Wait Time

The **spb isis spf-wait** command is used to configure the time intervals between the first, second, and subsequent ISIS-SPB shortest path first (SPF) calculations.

Subsequent SPF calculations, if required, are generated at exponentially increasing intervals of the SPF second wait time interval until the maximum wait time interval value is reached. For example, if the second-wait interval value is set to 1000 milliseconds, then the next SPF calculation is triggered after 2000 milliseconds and the next SPF calculation after that is triggered at 4000 milliseconds, and so on, until the maximum-wait interval value is reached.

When the maximum interval value is reached, the SPF wait interval will stay at the maximum value until there are no more SPF calculations scheduled during that interval. After a full interval without any SPF calculations, the SPF wait interval will reset back to the initial wait time interval value.

The following **spb isis spf-wait** command parameters are used to configure the SPF timers:

- **max-wait**—The maximum number of milliseconds to wait between two consecutive SPF calculations. The default maximum wait time value is set to 1000 milliseconds. Specify a maximum value that is the same or greater than the second wait time value.
- **initial-wait**—The number of milliseconds to wait before triggering an initial SPF calculation after a topology change. The default initial wait time value is set to 100 milliseconds. Specify a value that is the same or less than the maximum wait time value.
- **second-wait**—The number of milliseconds to wait between the first and second SPF calculation. The default second wait time value is set to 300 milliseconds. Specify a value that is the same or less than the maximum wait time value.

For example, the following command changes the SPF wait time values for the local SPB instance:

```
-> spb isis spf-wait max-wait 2500 initial-wait 1000 second-wait 1500
```

To change one or more of the wait time values, it is only necessary to specify the parameter for the desired change. For example:

```
-> spb isis spf-wait max-wait 5000
-> spb isis spf-wait initial-wait 1000
-> spb isis spf-wait second-wait 2000
```

To set the wait time values back to the default settings, use the **spb isis spf-wait** command without specifying any of the parameters. For example:

```
-> spb isis spf-wait
```

Configuring the Link State Packet Wait Time

The **spb isis lsp-wait** command is used to configure the time intervals between the first, second, and subsequently generated link state packets (LSPs).

Subsequent LSP, if required, are generated at exponentially increasing intervals of the LSP second wait time interval until the maximum value is reached. For example, if the second-wait interval value is set to 10 seconds, then the next LSP is generation is triggered after 20 seconds and the next LSP generated after that is triggered at 40 seconds, and so on, until the maximum wait time interval value is reached.

When the maximum interval value is reached, the LSP wait interval will stay at the maximum value until there are no more LSP generations during that interval. After a full interval without any LSP generations, the LSP wait interval will reset back to the initial wait time interval value.

The following **spb isis lsp-wait** command parameters are used to configure the SPF timers:

- **max-wait**—The maximum number of seconds to wait between two consecutively generated LSPs. The default maximum wait time value is set to 1000 milliseconds. Specify a maximum value that is the same or greater than the second wait time value.
- **initial-wait**—The number of seconds to wait before triggering an initial LSP generation after a topology change. The default initial wait time value is set to 0 milliseconds. Specify a value that is the same or less than the maximum wait time value.
- **second-wait**—The minimum number of seconds to wait between the first and second generated LSPs. The default second wait time value is set to 300 milliseconds. Specify a value that is the same or less than the maximum wait time value.

For example, the following command changes the LSP wait time values for the local SPB instance:

```
-> spb isis lsp-wait max-wait 2000 initial-wait 1000 second-wait 1500
```

To change one or more of the wait time values, it is only necessary to specify the parameter for the desired change. For example:

```
-> spb isis lsp-wait max-wait 5000
-> spb isis lsp-wait initial-wait 2500
-> spb isis lsp-wait second-wait 3000
```

To set the wait time values back to the default settings, use the **spb isis lsp-wait** command without specifying any of the parameters. For example:

```
-> spb isis lsp-wait
```

Configuring the Overload State

This implementation of ISIS-SPB supports the overload state mechanism, which allows an instance of ISIS-SPB to inform its neighbors that the instance is nearing or exceeding its capabilities. When peers see that a switch is advertising in this state, they will select an alternate path around the overloaded switch.

The ISIS-SPB instance for a switch may dynamically trigger the overload state condition when the instance detects that it is nearing or has reached resource limits. However, it is also possible to manually trigger the overload state condition using the **spb isis overload** command. For example:

```
-> spb isis overload
```

Some advantages of manually triggering the overload state condition, even if the instance is nowhere near its resource limits, are as follows:

- The switch is designated as “leaf node” that should never carry transit traffic. Configuring the link metric value for the SPB interfaces on the switch and attached peers is another method for preventing the switch from receiving transit traffic, but enabling the overload state is a much quicker way to achieve the same results and requires less configuration.
- When there is a need to remove the switch from service (temporarily or permanently). In this scenario, network availability is increased because peer switches will detect the overload state of the switch and gracefully transition to alternate paths, while the “manually overloaded” switch continues to forward packets. Just simply shutting the switch down would cause more disruption to network traffic.

When the overload state is either dynamically or manually enabled for the switch, the overload bit is set in LSP 0 to indicate that this ISIS-SPB instance is not available to accept transit traffic. However, an ISIS-SPB switch operating in the overload state is still used only if there is no alternate path to reach the intended destination.

When the overload state is enabled, the switch will operate in this state for an infinite amount of time. To configure the switch to remain in the overload state for only a specific amount of time (in seconds), use the **spb isis overload** command with the optional **timeout** parameter. For example:

```
-> spb isis overload timeout 500
```

To disable the overload state, use the **no** form of the **spb isis overload** command. For example:

```
-> no spb isis overload
```

It is also possible to specify that the overload state is enabled for the switch after every system bootup. This is done using the **spb isis overload-on-boot** command, which also has an optional **timeout** parameter. For example:

```
-> spb isis overload-on-boot timeout 500
```

To disable the overload-on-boot option, use the **no** form of the **spb isis overload-on-boot** command. For example:

```
-> no spb isis overload-on-boot timeout 500
```

Note that the **no spb isis overload** command does not disable the overload-on-bootup option.

Configuring Redundant Switches for Graceful Restart

By default, ISIS-SPB graceful restart is disabled. When graceful restart is enabled, the switch can either be a helper (which helps a neighbor router to restart) or a restarting router, or both. When graceful restart is enabled on the switch, the helper mode is automatically enabled by default.

To configure ISIS-SPB graceful restart support on an OmniSwitch, use the **spb isis graceful-restart** command. For example, to configure graceful restart on the router, enter:

```
-> spb isis graceful-restart
```

The helper mode can be disabled on the switch with the **spb isis graceful-restart helper** command. For example, to disable the helper support for neighboring switches, enter the following:

```
-> ip isis graceful-restart helper disable
```

To disable support for graceful restart, use the **no** form of the **spb isis graceful-restart** command. For example:

```
-> no spb isis graceful-restart
```

Enabling/Disabling ISIS-SPB

By default ISIS-SPB is disabled on the switch. To enable ISIS-SPB, use the **spb isis admin-state** command with the **enable** option. For example:

```
-> spb isis admin-state enable
```

To disable the ISIS-SPB instance on the switch, enter the **spb isis admin-state** command with the **disable** option. When the ISIS-SPB status is disabled for the switch, the related configuration settings and statistics are retained.

```
-> spb isis admin-state disable
```

Note. Enabling ISIS-SPB on a switch starts the process of ISIS-SPB discovery, adjacency building, and shortest path tree calculations. Make sure that the SPB-M configuration is set up first, then enable ISIS-SPB on each switch that will participate in the SPB-M network.

Creating an SPB Service

An SPB service is identified by a service ID number, which represents an association between a backbone service instance identifier (I-SID) and an existing BVLAN. Basically, creating an SPB service binds the backbone I-SID to a BVLAN ID. All traffic mapped to the specific I-SID is then encapsulated and forwarded on the associated BVLAN to the intended destination.

The **service spb** command is used to create an SPB service. For example, the following command creates SPB service 1 and binds I-SID 100 to BVLAN 4001:

```
-> service spb 1 isid 500 bvlan 4001
```

The BVLAN ID specified with the **service spb** command must already exist in the switch configuration. However, the I-SID number specified creates a new I-SID that is bound to the BVLAN for this service.

Note. When adding another BVLAN to an existing SPB-M topology instance, create the new BVLAN and its associated ECT ID on every switch first, then configure the SPB service association for the BVLAN. Creating SPB services before the BVLAN configuration is complete on all switches can cause problems with forming adjacencies or may even cause an SPB switch to drop existing adjacencies.

Modifying Default SPB Service Parameters

The following SPB service parameter values are set by default at the time the service is created. If necessary, use the specified commands to change the default values.

Parameter Description	Command	Default
Service description.	service spb description	None
Administrative status for statistics collection.	service spb stats	Disabled
Multicast replication mode	service spb multicast-mode	head-end
VLAN translation	service spb vlan-xlation	Disabled
Administrative status of the service	service spb admin-state	Disabled

Refer to the *OmniSwitch CLI Reference Guide* for more information about the above parameters and related commands.

Using VLAN Translation

VLAN translation refers to the egress translation of VLAN tags on service access points (SAPs). When enabled for a service, the VLAN tags for outgoing customer frames on SAPs associated with that service are processed according to the local SAP configuration (the SAP on which the frames will egress) and not according to the configuration of the SAP on which the frames were received.

- If the local SAP is configured for untagged traffic (*slot/port:0*), the egress traffic is always sent out as untagged.
- If the local SAP is configured for 802.1q-tagged traffic (*slot/port:ctag*), the egress traffic is single-tagged with the tag value specified by the *ctag* (customer VLAN tag) value.
- If the local SAP is configured for double-tagged traffic (*slot/port:outer_tag.:inner_tag*), the egress traffic is double-tagged with the tag values specified by the *outer_tag* and *inner_tag* values.

When VLAN translation is disabled, frames simply egress without any modification of the VLAN tags. In other words, the frames are transparently bridged without tag modification.

The following table shows the required translation (tag is added or replaced) that takes place when the egress SAP configuration is applied to the possible frame types (untagged, tagged, double-tagged). Note that in this table the terms “ITAG” and “OTAG” refer to inner tag and outer tag, respectively.

Egress SAP (action required based on SAP type)			
	Untagged SAP	Single Tagged SAP	Double-Tagged SAP
Incoming Frame	Remove OTAG Remove ITAG	Replace OTAG (Note: Replace = implicit add) Remove ITAG	Replace OTAG (Note: Replace = implicit add) Add/Replace ITAG
Untagged	No tags, so no action taken	Add the SAP OTAG	Add the SAP OTAG Add the SAP ITAG.
Single-tagged	Remove the OTAG	Replace the OTAG	Add ITAG Replace OTAG
Double-tagged	Remove the ITAG Remove the ITAG	Remove the ITAG Replace the OTAG	Replace ITAG Replace OTAG

VLAN translation is enabled at two different levels: the service level and access port level. To enable translation at the service level, use the **service spb vlan-xlation** command. For example:

```
-> service spb 1 vlan-xlation enable
```

To enable VLAN translation for all services, use the **all** parameter with the same command. For example:

```
-> service spb all vlan-xlation enable
```

To disable VLAN translation, use the **service spb vlan-xlation** command with the disable parameter. For example:

```
-> service spb 1 vlan-xlation disable
-> service spb all vlan-xlation disable
```

To enable VLAN translation at the port level, use the **service access vlan-xlation** command. For example:

```
-> service access port 1/11 vlan-xlation enable
```

See “[Configuring Service Access Ports](#)” on page 7-40 for more information.

Enable the Service

By default, the SPB service is disabled when the service is created. Once the service is created and any optional service parameters are configured, use the **service spb admin-state** command with the **enable** option to enable the service. For example:

```
-> service spb 1 admin-state enable
```

To disable the service, enter the following command:

```
-> service spb 1 admin-state disable
```

Deleting an SPB Service

Before deleting a service from the switch configuration, disable the administrative status of the service. Once this is done, use the **no** form of the **service spb** command to delete the service. For example:

```
-> no service spb 1
```

Verifying the SPB Service Configuration

To view the SPB service configuration for the switch, use the **show spb isis services** command. For example:

```
-> show service spb
```

Legend: * denotes a dynamic object

SPB Service Info

```
SystemId : 00e0.ble7.0188, SrcId : 0x70188, SystemName : BEB-1
```

ServiceId	Adm	Oper	Stats	SAP Count	Bind Count	Isid	BVlan	MCast Mode	(T/R)
1	Up	Up	N	4	1	1000	4001	Headend	(0/0)
2	Up	Up	N	4	1	1001	4001	Headend	(0/0)
3	Up	Up	N	4	1	1002	4001	Headend	(0/0)
4	Up	Up	N	4	1	1003	4001	Headend	(0/0)
5	Up	Up	N	4	1	1004	4001	Headend	(0/0)
6	Up	Up	N	4	1	1005	4001	Headend	(0/0)
7	Up	Up	N	4	1	1006	4001	Headend	(0/0)
8	Up	Up	N	4	1	1007	4001	Headend	(0/0)
9	Up	Up	N	4	1	1008	4001	Headend	(0/0)
10	Up	Up	N	4	1	1009	4001	Headend	(0/0)

To view the configuration for an individual service, use the **show spb isis services** command and specify the SPB service ID. For example:

```
-> show service spb 1
```

SPB Service Detailed Info

```
Service Id       : 1,
ISID             : 1000,
Multicast-Mode  : Headend,
Admin Status    : Up,
Stats Status    : No,
Service Type    : SPB,
MTU             : 9194,
SAP Count       : 4,
Ingress Pkts   : 0,
Egress Pkts    : 0,
Mgmt Change    : 08/10/2012 13:14:43,
Description     : ,
BVlan          : 4001,
Tx/Rx Bits     : 0/0,
Oper Status    : Up,
Vlan Translation : No,
Allocation Type : Static,
Def Mesh VC Id : 1,
SDP Bind Count : 1,
Ingress Bytes  : 0,
Egress Bytes   : 0,
Status Change  : 08/10/2012 13:14:00
```

Configuring Service Access Points (SAPs)

A SAP identifies the location where customer traffic enters the Provider Backbone Bridge Network (PBBN) edge, the type of customer traffic to service, parameters to apply to the traffic, and the service that will process the traffic for tunneling through the provider network.

Configuring a SAP requires several steps. These steps are outlined here and further described throughout this section:

- Configure customer-facing ports or link aggregates as service access ports.
- Configure Layer 2 profiles to determine how control packets are processed on access ports.
- Create a SAP by associating a SAP ID with an SPB service ID. A SAP ID is comprised of an access port and an encapsulation value, which is used to identify the type of customer traffic (untagged, single-tagged, or double-tagged) to map to the associated service.

SAP Configuration Guidelines

Consider the following when configuring a SAP:

- A SAP is a unique local entity for any given device. The same SAP ID value can be used on other BEB switches.
- There are no SAPs configured by default; explicit configuration of a SAP is required.
- A SAP is administratively disabled at the time the SAP is created.
- When a SAP is deleted, all configuration parameters for the SAP are also deleted.
- A SAP is owned by and associated with the service that was specified at the time the SAP was created.
- If a port is administratively shutdown, all SAPs on that port become operationally out of service.
- Both fixed ports and link aggregates are configurable as access ports. Only access ports are associated with SAPs.
- Bridging functionality is not supported on access ports or link aggregates.
- Configuring multiple SAPs on an access port that map different VLAN tags to the same service can cause a MAC move when the same customer MAC (CMAC) ingresses the access port with different VLAN tags. For example, a CMAC has two flows tagged with VLAN 10 and VLAN 20 ingressing access port 1/1 and both are mapped to service 100.

```
-> service spb 100 sap port 1/1:10
-> service spb 100 sap port 1/1:20
```

To avoid the MAC move in this scenario, use one of the following alternative SAP configurations.

Configure the SAPs with different services:

```
-> service spb 100 sap port 1/1:10
-> service spb 200 sap port 1/1:20
```

Configure a default SAP to classify both flows into the same service:

```
-> service spb 100 sap port 1/1:all
```

See [“Creating the Service Access Point” on page 7-42](#) for more information.

Configuring Service Access Ports

Each SAP is comprised of an access port or link aggregate and an encapsulation type value. Access ports are customer-facing ports that reside on a provider edge router. Traffic received on these ports is classified for one or more SAPs and forwarded onto the intended destination by the associated SPB service.

To configure a port or link aggregate as an access port, use the [service access](#) command. For example, the following command configures port 1/2 and link aggregate 5 as access ports:

```
-> service access port 1/2
-> service access linkagg 5
```

To revert an access port back to a regular switch port or link aggregate, use the no form of the service access command. For example:

```
-> no service access port 1/2
-> no service access linkagg 5
```

VLAN Translation on Access Ports

VLAN translation refers to the egress translation of VLAN tags on service access points (SAPs). For more information about VLAN translation is applied, see [“Using VLAN Translation” on page 7-36](#).

By default, VLAN translation is disabled on access ports. Enabling VLAN translation on an access port implicitly enables translation for all SAPs associated with that port. However, translation must also be enabled for the services associated with these SAPs. This ensures that all SAPs associated with a service will apply VLAN translation.

To enable VLAN translation on an access port, use the [service access vlan-xlation](#) command with the **enable** option. For example:

```
-> service access port 1/3 vlan-xlation enable
-> service access linkagg 10 vlan-xlation enable
```

To disable VLAN translation on an access port, use the [service access vlan-xlation](#) command with the **disable** option. For example:

```
-> service access port 1/3 vlan-xlation disable
-> service access linkagg 10 vlan-xlation disable
```

Configuring Layer 2 Profiles for Access Ports

A Layer 2 profile determines how control frames ingressing on an access port are processed. When a port is configured as an access port, a default Layer 2 profile (**def-access-profile**) is applied to the port with the following default values for processing control frames:

Protocol	Default
STP	tunnel
802.1x	drop
802.1ab	drop
802.3ad	peer
GVRP	tunnel
MVRP	tunnel
AMAP	discard

If the default profile values are not sufficient, use the **service l2profile** command with the **tunnel**, **discard**, and **peer** options to create a new profile. For example, the following command creates a profile named “DropL2”:

```
-> service l2profile DropL2 stp discard gvrp discard 802.1ab discard
```

Consider the following when configuring Layer 2 profiles:

- Not all of the control protocols are currently supported with the **peer**, **tunnel**, and **discard** parameters. Use the following table to determine the parameter combinations that are supported:

Protocol	Reserved MAC	peer	discard	tunnel
STP	01-80-C2-00-00-00	no	yes	yes
802.1x	01-80-C2-00-00-03	no	yes	yes
802.1ab	01-80-C2-00-00-0E	yes	yes	yes
802.3ad	01-80-C2-00-00-02	yes	no	no
GVRP	01-80-C2-00-00-21	no	yes	yes
MVRP	—	no	yes	yes
AMAP	00-20-DA-00-70-04	yes	yes	no

- When a profile is created, the new profile inherits the default profile settings for processing control frames. The default settings are applied with the new profile unless they are explicitly changed. For example, the profile “DropL2” was configured to discard STP, GVRP, and 802.1ab frames. No other protocol settings were changed, so the default settings still apply for the other protocols.
- Remove any profile associations with access ports before attempting to modify or delete the profile.

To delete a Layer 2 profile, use the **no** form of the **service l2profile** command. For example, the following command deletes the “DropL2” profile:

```
-> no service l2profile DropL2
```

Use the **show service l2profile** command to view a list of profiles that are already configured for the switch. This command also displays the attribute values for each profile.

Assigning Layer 2 Profiles to Access Ports

After a Layer 2 profile is created, it is then necessary to assign the profile to an access port or link aggregate. When this is done, the current profile associated with the port is replaced with the new profile.

The **service access l2profile** command is used to assign a new profile to an access port. For example, the following command assigns the “DropL2” profile to access port 1/4:

```
-> service access port 1/4 l2profile DropL2
-> service access linkagg 5 l2profile DropL2
```

To change the profile associated with the access port back to the default profile (**def-access-profile**), use the **default** option with the **service access l2profile** command. For example:

```
-> service port 1/4 l2profile default
-> service access linkagg 5 l2profile DropL2
```

Use the **show service access** command to display profile associations for access ports.

Verifying the Access Port Configuration

To view the access port configuration for the switch, use the `show service access` command. For example:

```
-> show service access
Port      Link  SAP   SAP   Vlan
Id        Status Type  Count Xlation L2Profile
-----+-----+-----+-----+-----+-----
1/11     Up    Manual 100   N      def-access-profile
1/12     Down  Manual 100   N      def-access-profile
1/13     Down  Manual 100   N      def-access-profile
1/14     Down  Manual 100   N      def-access-profile
1/15     Down  Dynamic 0     Y      def-access-profile
1/16     Up    Dynamic 1     Y      def-access-profile
1/17     Down  Dynamic 0     Y      def-access-profile
1/18     Down  Dynamic 0     Y      def-access-profile
```

Total Access Ports: 8

Creating the Service Access Point

Each SPB service is bound to at least one Service Access Point (SAP). A SAP identifies the point at which customer traffic enters the Provider Backbone Bridge Network (PBBN). Creating a SAP on an SPB switch designates that switch as a Backbone Edge Bridge (BEB) in the PBBN. An SPB switch that does not have a SAP but does have at least one BVLAN and an SPB interface is designated as Backbone Core Bridge (BCB) in the PBBN.

Once the SPB topology is determined and switches that will serve as BEBs are identified, a SAP is created on each BEB. A SAP is created by associating a SAP ID with an SPB service. A SAP ID is comprised of a customer-facing port (referred to as an access port) and an encapsulation value that is used to identify the type of customer traffic (untagged, single-tagged, or double-tagged) to map to the associated service.

The `service spb sap` command is used to configure a SAP. This command specifies the SPB service ID number and the SAP ID (slot/port:encapsulation). The following parameter values are used with this command to specify the encapsulation value:

SAP Encapsulation Value	Customer Traffic Serviced
0 (null)	All untagged packets; tagged packets are dropped.
all	All tagged and untagged packets not already classified into another SAP*
<i>qtag</i>	Only traffic 802.1q-tagged with the specified VLAN ID.
<i>outer_qtag.innnger_qtag</i>	Only traffic double-tagged (QinQ) with the specified outer and inner VLAN IDs.

*Note that the **:all** (wildcard) parameter is also configurable as the inner tag value for double-tagged frames (for example, "10:all" specifies double-tagged packets with an outer tag equal to 10 and an inner tag with any value).

The following `service spb sap` command example creates a SAP that will direct customer traffic ingressing on access port 1/4 that is tagged with VLAN ID 50 to service 100:

```
-> service spb 100 sap 1/4:50 description "BEB1 to SPB100 CVLAN 50"
```

In the above example, the 1/4:50 designation is referred to as the SAP ID or the encapsulation ID. This means that if no other SAPs are configured for port 1/4, then any traffic ingressing on that port is dropped if the traffic is not tagged with VLAN 50.

It is possible to configure more than one SAP for the same access port, which provides a method for segregating incoming traffic into multiple services. For example, the following SAP configuration for port 2/3 sends incoming traffic to three different services based on the VLAN tags of the frames received:

```
-> service spb 2000 sap port 2/3:all
-> service spb 200 sap port 2/3:100
-> service spb 1000 sap port 2/3:100.200
```

In this example,

- Frames double-tagged with 100 (outer tag) and 200 (inner tag) are sent on service 1000.
- Frames single-tagged with VLAN 100 are sent on service 200.
- All other frames (those that are not single-tagged with 100 or double-tagged with 100 and 200) are sent on service 2000.

The following SAP ID classification precedence is applied when there are multiple SAPs for one access port:

- 1 Double-tagged (Outer VLAN + Inner VLAN) - Highest
- 2 Double-tagged (Outer VLAN + all)
- 3 Single-tagged (VLAN)
- 4 Single-tagged (wildcard)
- 5 Untagged - Lowest.

Modifying Default SAP Parameters

The following parameter values are set by default at the time the SAP is created. If necessary, use the specified commands to change the default values.

Parameter Description	Command	Default
SAP description.	service spb sap description	None
SAP trust mode	service spb sap trusted	Trusted
Administrative status for the SAP	service spb sap admin-state	Disabled
Administrative status for statistics collection.	service spb sap stats	Disabled

Refer to the *OmniSwitch AOS Release 8 CLI Reference Guide* for more information about the command parameters.

Configuring the SAP Trust Mode

The **service spb sap trusted** command is used to configure the trust mode for a SAP. A trusted SAP can accept 802.1p values in incoming packets; an untrusted SAP will set any 802.1p values to zero in incoming packets, unless an 802.1p value is configured with this command.

Note that untagged Layer 2 control packets (for example, BPDU, GVRP, and AMAP) are always tunneled (if enabled) through the Provider Backbone Bridge (PBB) network with the default EXP bits set to 7, so that they can arrive at the destination bridge at the highest COS queue of 7. As a result, trusted and untrusted SAPs configured on the access ports will not affect the Layer 2 control packets ingressing on the access ports.

By default, a SAP is trusted with the priority set to best effort (zero). Use the **no** form of the **service spb sap trusted** command with the **priority** option to change the SAP mode to untrusted. For example:

```
-> service spb 100 sap 1/4:50 no trusted priority 7
```

When a SAP is trusted, the priority value contained in tagged customer packets is used; untagged packets are assigned the default priority value (zero). When a SAP is untrusted, the priority value configured for the SAP is assigned to both tagged and untagged customer packets.

Enabling/Disabling the SAP

By default, a SAP is disabled at the time the SAP is created. To enable the SAP administrative status, use the **service spb sap admin-state** command. For example:

```
-> service spb 100 sap port 1/4:50 admin-state enable
-> service spb 200 sap linkagg 5:all admin-state enable
```

To disable the SAP, enter the following command:

```
-> service spb 100 sap port 1/4:50 admin-state disable
-> service spb 200 sap linkagg 5:all admin-state disable
```

Deleting the SAP

When a SAP is administratively disabled, the SAP configuration is not removed from the switch. To delete a SAP from the switch configuration, use the **no** form of the **service spb sap** command. For example:

```
-> service spb 100 no sap port 1/4:50
-> service spb 200 no sap linkagg 5:all
```

Verifying the SAP Configuration

A SAP is a type of virtual port that is associated with an SPB service. To determine the SAP configuration for a specific service, use the **show service spb ports** command to view the virtual ports associated with a specific service. For example:

```
-> show service spb 1 ports
Legend: * denotes a dynamic object
SPB Service Info
  Admin : Up, Oper : Up, Stats      : N, Mtu      : 9194,   VlanXlation : N,
  ISID  : 1000,    BVlan : 4001,    MCast-Mode : Headend, Tx/Rx      : 0/0

Identifier      Adm  Oper  Stats  Sap Trusted:Priority/  Sap Description /
-----+-----+-----+-----+-----+-----+-----
sap:1/11:1000   Up   Up    N      Y:x                   1/11             -
sap:1/12:1000   Up   Down  N      Y:x                   1/12             -
sap:1/13:1000   Up   Down  N      Y:x                   1/13             -
sap:1/14:1000   Up   Down  N      Y:x                   1/14             -
sdp:32776:1*    Up   Up    Y      e8e7.3233.1831:4001  1/1             BEB-1

Total Ports: 5
```

To then view configuration information for a specific SAP, use the **show service spb sap** command. For example:

```
-> show service spb 1 sap port 1/11:1000
```

```
SAP Detailed Info
```

SAP Id	: 1/11:1000,	Description	: ,
Admin Status	: Up,	Oper Status	: Up,
Stats Status	: No,	Vlan Translation	: No,
Service Type	: SPB,	Allocation Type	: Static,
Trusted	: Yes,	Priority	: 0,
Ingress Pkts	: 0,	Ingress Bytes	: 0,
Egress Pkts	: 0,	Egress Bytes	: 0,
Mgmt Change	: 08/07/2012 23:39:29,	Status Change	: 08/10/2012 15:13:08

Configuring IP over SPB

As described in section “[IP over SPBM](#)” on page 7-15, there are two approaches for routing L3 traffic over a L2 SPBM backbone network: VPN-Lite and L3 VPN. The following general steps are used to configure each one of these solutions:

1 Configure the L3 VPN loopback for both VPN-Lite and L3 VPN scenarios. Identify the BEBs that will participate in routing L3 traffic through the SPBM core. On each of these BEBs, configure the required loopback port configuration. For example:

```
-> vlan 200
-> vlan 200 members 1/1 tagged
-> spb bvlan 500
-> service access port 1/2
-> service 1000 spb isid 1000 bvlan 500 admin-state enable
-> service 1000 sap port 1/2:200
-> vrf-1
-> vrf-1 ip interface L3vpn1 vlan 200 address 10.1.1.1/24
```

In this example, VLAN 200, port 1/1, access port 1/2, and IP interface “L3vpn1” will serve as the L3 VPN components required for the loopback configuration. A physical cable will connect port 1/1 to access port 1/2. The SPB BVLAN and I-SID are required to create the SAP for access port 1/2.

2 Configure VPN-Lite routing protocols. If using the VPN-Lite approach, configure the routing protocols on the “L3vpn1” IP interface created in Step 1. Otherwise, skip Step 2 and go to Step 3. For example:

```
-> vrf-1 ip static-route 20.0.0.0/24 gateway 10.1.1.2
```

The VPN-Lite approach only requires configuring the physical L3 VPN loopback and configuring routing protocols on the L3 VPN IP interface to exchange routes. The remaining steps in this section are used to configure the L3 VPN approach, which uses ISIS-SPB to exchange routes.

3 Configure VRF-ISID bindings for the L3 VPN. A VRF-ISID binding identifies the loopback port configuration that will do L3 forwarding on the VRF side of the loopback and SPB bridging on the SAP side of the loopback. VRF import and export commands are used to exchange routes between the VRF and I-SID specified in the binding configuration. For example:

```
-> spb ipvpn bind vrf-1 isid 1000 gateway 10.1.1.1 all-routes
-> vrf-1 ip export all-routes
-> vrf-1 ip import isid 1000 all-routes
```

In this example, “vrf-1” is bound to SPB I-SID 1000 and gateway 10.1.1.1 identifies the loopback IP interface. All routes in “vrf-1” are exported to the Global Route Manager (GRM), which then exports the routes to I-SID 1000. The last command in this sequence sets up the import of I-SID 1000 routes from the GRM into “vrf-1”. The **all-routes** parameter specifies that no route-map filtering is applied to exported or imported routes; all routes are allowed.

4 Optionally configure route redistribution between VRFs and/or I-SIDs. Route redistribution is configurable between a VRF and I-SID or between two I-SIDs (inter-I-SID route leaking). For example:

```
-> spb ipvpn redistrib source-isid 2000 destination-isid 1000 all-routes
-> spb ipvpn redistrib source-vrf-2 destination-isid 2000 all-routes
```

Verifying L3 VPN Configuration and Routes

VRFs are bound to I-SIDs to identify a VRF mapping to a specific SPB service instance for the purposes of exchanging routes between the VRF and I-SID via the switch GRM. To verify the VRF mapping configuration on the local switch, use the [show spb ipvpn bind](#) command. For example:

```
-> show spb ipvpn bind
Legend: * indicates bind entry is active
SPB IPVPN Bind Table:
      VRF                ISID                Gateway                Route-Map
-----+-----+-----+-----
* vrf-1                1000                1.1.1.2
* vrf-2                2000                2.2.2.2

Total Bind Entries: 2
```

In addition to exchanging routes between VRFs and I-SIDs, it is also possible to configure redistribution of routes between two I-SIDs or between a VRF and an I-SID. To verify the redistribution configuration for L3 VPN routes, use the [show spb ipvpn redist](#) command. For example:

```
-> show spb ipvpn redist
Legend: * indicates redist entry is active
SPB IPVPN Redist ISID Table:
      Source-ISID        Destination-ISID        Route-Map
-----+-----+-----
* 4001                  4003
* 4003                  4001

Total Redist ISID Entries: 2
```

To display the L3 VPN route table, use the [show spb ipvpn route-table](#). For example:

```
-> show spb ipvpn route-table
Legend: * indicates IPVPN route has matching locally configured ISID
SPB IPVPN Route Table:
      ISID  Destination                Gateway                Source Bridge                Metric
-----+-----+-----+-----+-----
* 4001    1.1.1.0/24                1.1.1.1                L2-DUT1 : 00:e0:b1:db:c3:65    1
* 4001    1.1.1.0/24                1.1.1.2                L2-DEV1 : e8:e7:32:00:23:f9    1
* 4001    2.2.2.0/24                1.1.1.2                L2-DEV1 : e8:e7:32:00:23:f9    1
* 4001    10.10.10.0/24            1.1.1.1                L2-DUT1 : 00:e0:b1:db:c3:65    1
* 4001    15.1.1.0/24              1.1.1.1                L2-DUT1 : 00:e0:b1:db:c3:65    1
* 4003    1.1.1.0/24                2.2.2.2                L2-DEV1 : e8:e7:32:00:23:f9    1
* 4003    2.2.2.0/24                2.2.2.1                L2-DUT2 : 00:e0:b1:dd:99:db    1
* 4003    2.2.2.0/24                2.2.2.2                L2-DEV1 : e8:e7:32:00:23:f9    1
* 4003    10.10.10.0/24            2.2.2.2                L2-DEV1 : e8:e7:32:00:23:f9    1
* 4003    15.1.1.0/24              2.2.2.2                L2-DEV1 : e8:e7:32:00:23:f9    1
```

IP over SPB Configuration Examples

This section contains diagrams and CLI command examples for configuring the following IP over SPB scenarios:

- [“Multiple I-SIDs” on page 7-48.](#)
- [“I-SID Routing in One VRF” on page 7-50.](#)
- [“I-SID Routing in Two VRFs” on page 7-52.](#)

Multiple I-SIDs

In this sample IP over SPB topology, Network A is able to communicate with Network B across two I-SIDs. This scenario could be expanded to connect multiple customer sites together to form a VPN cloud.

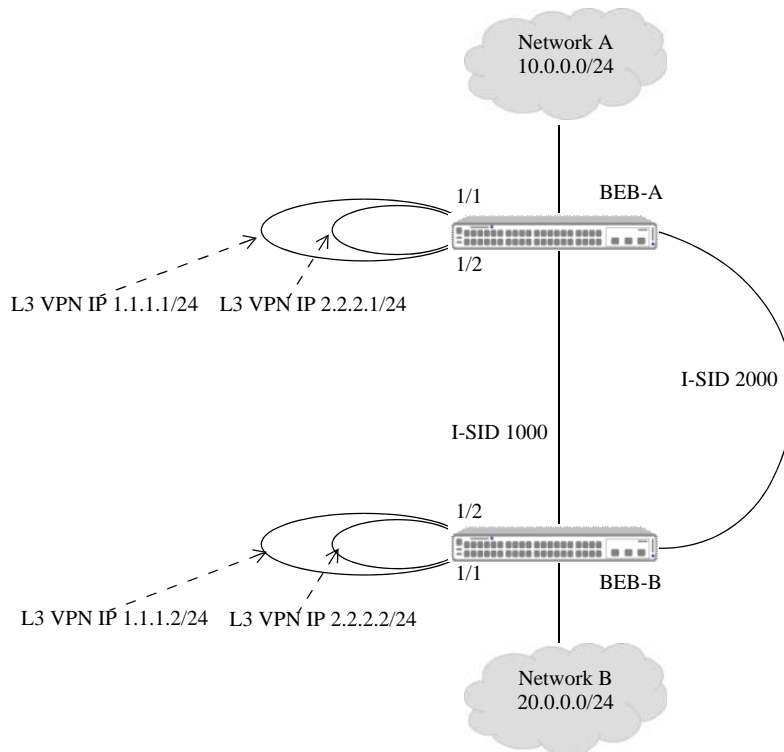

Figure 8: Multiple I-SIDS

The following CLI command examples are used to configure the sample IP over SPB topology shown in “[Figure 8: Multiple I-SIDS](#)” on page 7-48. In this topology, port 1/1 is the L3 VPN router port, port 1/2 is the L3 VPN access port, and VLAN 200 and VLAN 400 are the L3 VPN VLANs.

Common for BEB-A and BEB-B:

```
-> service access port 1/2
-> vlan 200
-> vlan 200 members port 1/1 tagged
-> vlan 400
-> vlan 400 members port 1/1 tagged
-> service 1000 spb isid 1000 bvlan 40 admin-state enable
-> service 1000 sap port 1/2:200 admin-state enable
-> service 2000 spb isid 2000 bvlan 41 admin-state enable
-> service 2000 sap port 1/2:400 admin-state enable
-> vrf-1
```

BEB-A:

```
-> vrf-1 ip interface l3vpn1 vlan 200 address 1.1.1.1/24
-> vrf-1 ip interface l3vpn2 vlan 400 address 2.2.2.1/24
```

BEB-B:

```
-> vrf-1 ip interface l3vpn1 vlan 200 address 1.1.1.2/24
-> vrf-1 ip interface l3vpn2 vlan 400 address 2.2.2.2/24
```

VPN-Lite

The following commands are used only in a VPN-Lite configuration:

BEB-A:

```
-> vrf-1 ip static-route 20.0.0.0/24 gateway 1.1.1.2
-> vrf-1 ip static-route 20.0.0.0/24 gateway 2.2.2.2
```

BEB-B:

```
-> vrf-1 ip static-route 10.0.0.0/24 gateway 1.1.1.1
-> vrf-1 ip static-route 10.0.0.0/24 gateway 2.2.2.1
```

L3 VPN

The following commands are used only in a L3 VPN configuration:

BEB-A:

```
-> vrf-1 ip export all-routes
-> spb ipvpn bind vrf-1 isid 1000 gateway 1.1.1.1 all-routes
-> spb ipvpn bind vrf-1 isid 2000 gateway 2.2.2.1 all-routes
-> vrf-1 ip import isid 1000 all-routes
-> vrf-1 ip import isid 2000 all-routes
```

BEB-B:

```
-> vrf-1 ip export all-routes
-> spb ipvpn bind vrf-1 isid 1000 gateway 1.1.1.2 all-routes
-> spb ipvpn bind vrf-1 isid 2000 gateway 2.2.2.2 all-routes
-> vrf-1 ip import isid 1000 all-routes
-> vrf-1 ip import isid 2000 all-routes
```

I-SID Routing in One VRF

In this sample IP over SPB configuration, Networks A and B can communicate with each other within the same VRF but on different I-SIDs due to the routing (redistribution) between I-SID 1000 and 2000 on BEB-C. In addition, Network C is also able to communicate with Networks A and B.

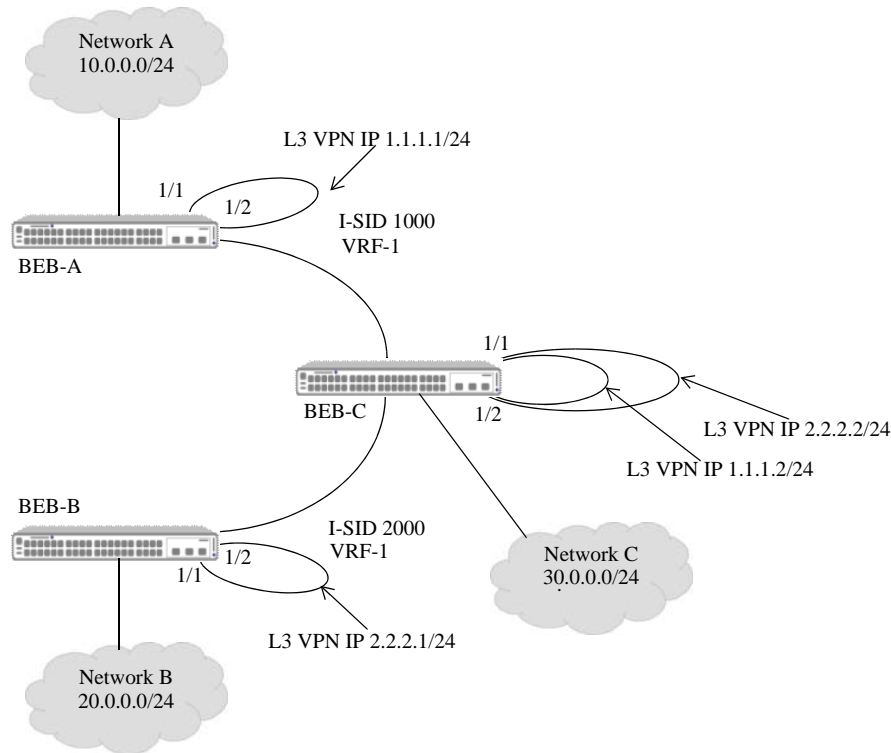

Figure 9: Inter-ISID Routing Example (One VRF)

The following CLI command examples are used to configure the sample IP over SPB topology shown in “[Figure 9: Inter-ISID Routing Example \(One VRF\)](#)” on page 7-50. In this topology, Network A binds to I-SID 1000 in VRF-1, Network B binds to I-SID 2000 in VRF-1, and Network C binds to both I-SIDs in VRF-1.

BEB-A:

```
-> service access port 1/2
-> vlan 200
-> vlan 200 members port 1/1 tagged
-> service 1000 spb isid 1000 bvlan 40 admin-state enable
-> service 1000 sap port 1/2:200 admin-state enable
-> vrf-1
-> vrf-1 ip interface l3vpn1 vlan 200 address 1.1.1.1/24
-> vrf-1 ip export all-routes
-> spb ipvpn bind vrf-1 isid 1000 gateway 1.1.1.1 all-routes
-> vrf-1 ip import isid 1000 all-routes
```

BEB-B

```
-> service access port 1/2
-> vlan 400
-> vlan 400 members port 1/1 tagged
-> service 2000 spb isid 2000 bvlan 41 admin-state enable
-> service 2000 sap port 1/2:400 admin-state enable
```



```
-> vrf-1
-> vrf-1 ip interface l3vpn2 vlan 400 address 2.2.2.1/24
-> vrf-1 ip export all-routes
-> spb ipvpn bind vrf-1 isid 2000 gateway 2.2.2.1 all-routes
-> vrf-1 ip import isid 2000 all-routes
```

BEB-C:

```
-> service access port 1/2
-> vlan 200
-> vlan 200 members port 1/1 tagged
-> vlan 400
-> vlan 400 members port 1/1 tagged
-> service 1000 spb isid 1000 bvlan 40 admin-state enable
-> service 1000 sap port 1/2:200 admin-state enable
-> service 2000 spb isid 2000 bvlan 41 admin-state enable
-> service 2000 sap port 1/2:400 admin-state enable
-> vrf-1
-> vrf-1 ip interface l3vpn1 vlan 200 address 1.1.1.2/24
-> vrf-1 ip interface l3vpn2 vlan 400 address 2.2.2.2/24
-> spb ipvpn bind vrf-1 isid 1000 gateway 1.1.1.2 all-routes
-> spb ipvpn bind vrf-1 isid 2000 gateway 2.2.2.2 all-routes
-> spb ipvpn redist source-isid 1000 destination-isid 2000 all-routes
-> spb ipvpn redist source-isid 2000 destination-isid 1000 all-routes
-> vrf-1 ip import all-routes
-> vrf-1 ip export all-routes
```

I-SID Routing in Two VRFs

In this sample IP over SPB configuration, Networks A and B can communicate with each other between two different VRFs on different I-SIDs due to the routing (redistribution) between I-SID 1000 and 2000 on BEB-C. In addition, Network C is also able to communicate with Networks A and B.

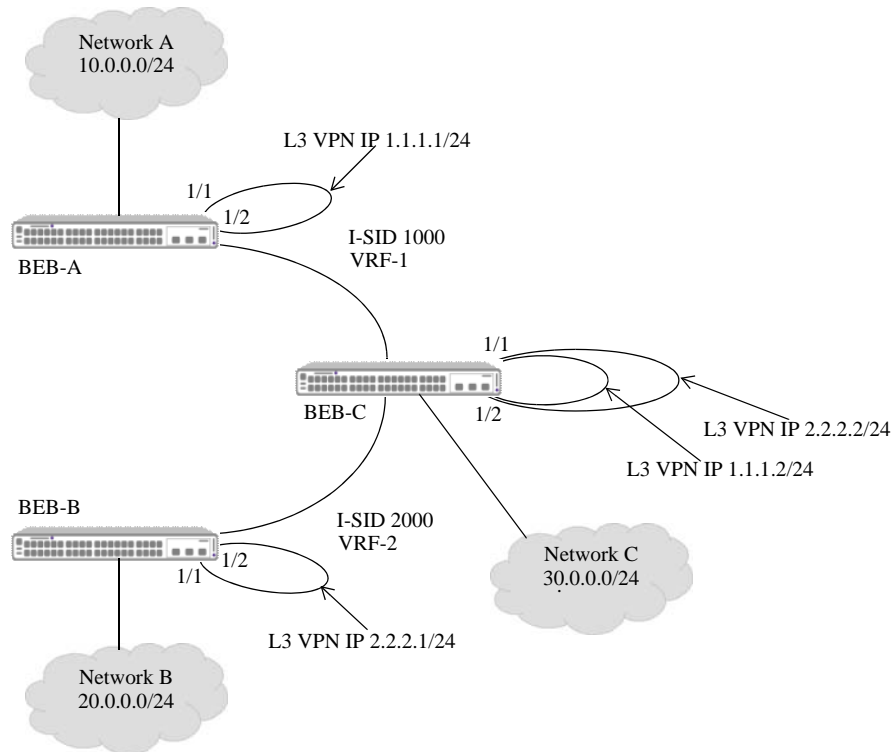

Figure 10: Inter-ISID Routing Example (Two VRF)

The following CLI command examples are used to configure the sample IP over SPB topology shown in “[Figure 10: Inter-ISID Routing Example \(Two VRF\)](#)” on page 7-52. In this topology, Network A binds to I-SID 1000 in VRF-1, Network B binds to I-SID 2000 in VRF-2, and Network C binds to both I-SIDs in VRF-1.

BEB-A:

```
-> service access port 1/2
-> vlan 200
-> vlan 200 members port 1/1 tagged
-> service 1000 spb isid 1000 bvlan 40 admin-state enable
-> service 1000 sap port 1/2:200 admin-state enable
-> vrf-1
-> vrf-1 ip interface l3vpn1 vlan 200 address 1.1.1.1/24
-> vrf-1 ip export all-routes
-> spb ipvpn bind vrf-1 isid 1000 gateway 1.1.1.1 all-routes
-> vrf-1 ip import isid 1000 all-routes
```

BEB-B

```
-> service access port 1/2
-> vlan 400
-> vlan 400 members port 1/1 tagged
-> service 2000 spb isid 2000 bvlan 41 admin-state enable
-> service 2000 sap port 1/2:400 admin-state enable
```

```
-> vrf-2
-> vrf-2 ip interface l3vpn2 vlan 400 address 2.2.2.1/24
-> vrf-2 ip export all-routes
-> spb ipvpn bind vrf-1 isid 2000 gateway 2.2.2.1 all-routes
-> vrf-2 ip import isid 2000 all-routes
```

BEB-C:

```
-> service access port 1/2
-> vlan 200
-> vlan 200 members port 1/1 tagged
-> vlan 400
-> vlan 400 members port 1/1 tagged
-> service 1000 spb isid 1000 bvlan 40 admin-state enable
-> service 1000 sap port 1/2:200 admin-state enable
-> service 2000 spb isid 2000 bvlan 41 admin-state enable
-> service 2000 sap port 1/2:400 admin-state enable
-> vrf-1
-> vrf-1 ip interface l3vpn1 vlan 200 address 1.1.1.2/24
-> vrf-1 ip interface l3vpn2 vlan 400 address 2.2.2.2/24
-> spb ipvpn bind vrf-1 isid 1000 gateway 1.1.1.2 all-routes
-> spb ipvpn bind vrf-2 isid 2000 gateway 2.2.2.2 all-routes
-> spb ipvpn redist source-isid 1000 destination-isid 2000 all-routes
-> spb ipvpn redist source-isid 2000 destination-isid 1000 all-routes
-> spb ipvpn redist source-vrf vrf-1 destination-isid 2000 all-routes
-> vrf-1 ip import isid 1000 all-routes
-> vrf-1 ip import isid 2000 all-routes
-> vrf-1 ip export all-routes
-> vrf-2 ip import vrf-1 all-routes
-> vrf-2 ip import isid 1000 all-routes
-> vrf-2 ip import isid 2000 all-routes
```

Verifying the SPB Backbone and Services

Displaying the SPB-M configuration is helpful to verify the actual configuration on each SPB switch in the topology and to troubleshoot ISIS-SPB backbone and SPB service connectivity.

Verifying the ISIS-SPB Backbone Configuration

To display information about the ISIS-SPB infrastructure (backbone), use the **show** commands listed in this section.

show spb isis info	Displays the global status and configuration for the ISIS-SPB instance on the switch.
show spb isis bvlan	Displays the backbone VLAN (BVLAN) configuration for the switch.
show spb isis interface	Displays the SPB interface (network port) configuration for the switch.
show spb isis adjacency	Displays information about the ISIS-SPB adjacencies created for the SPB switch.
show spb isis database	Displays ISIS-SPB topology information maintained in the link state database (LSDB).
show spb isis nodes	Displays the discovered node-level parameter values for all of the ISIS-SPB switches participating in the topology.
show spb isis unicast-table	Displays the unicast forwarding information for the BVLAN topology.
show spb isis services	Displays a network-wide view of existing services to help verify that SPB services are correctly advertised and learned by ISIS-SPB
show spb isis spf	Displays the shortest path first (SPF) information to all known SPB switches for a specific BVLAN.
show spb isis multicast-table	Displays the multicast forwarding entries for services.
show spb isis multicast-sources	Displays all the known multicast sources across the SPB domain and BVLANs.
show spb isis multicast-sources-spf	Displays the shortest path first (SPF) readability for a known multicast source bridge for a specific BVLAN.
show spb isis ingress-mac-filter	Displays the ingress MAC filter for multicast traffic for a given BVLAN operating in the (*,G) mode.

Verifying the SPB Service Configuration

To display information about the Service Manager configuration for SPB service connectivity, use the **show** commands listed in this section

show service access	Displays the service access (customer-facing) port configuration.
show service l2profile	Displays the Layer 2 profile definitions. These profiles are applied to service access ports to determine how Layer 2 control protocol frames are processed on these ports.
show service	Displays the service configuration.
show service spb ports	Displays all the virtual ports (SAPs, SDPs) that are associated with an SPB service.
show service spb sap	Displays the configuration information for the specified SAP ID associated with the specified service.
show service sdp	Displays the dynamic Service Distribution Point (SDP) configuration.
show service mesh-sdp	Displays the dynamic SDP-to-service binding configuration.
show service spb debug-info	Displays debug information for the virtual ports associated with the SPB service.
show service spb counters	Displays the traffic statistics for the specified SPB service and associated virtual ports.
clear service spb counters	Clears the traffic statistics for the specified SPB service and associated virtual ports.

For more information about the resulting displays from these commands, see the *OmniSwitch AOS Release 8 CLI Reference Guide*.

8 Configuring Loopback Detection

Loopback Detection (LBD) automatically detects the loop and shutdown the port involved in the loop. This prevents forwarding loops on ports that have forwarded network traffic which has looped back to the originating switch. LBD detects and prevents Layer 2 forwarding loops on a port either in the absence of other loop detection mechanisms such as STP/RSTP/MSTP, or when these mechanisms cannot detect it (for example, a client's equipment may drop BPDUs, or the STP protocol may be restricted to the network edge).

A provider network with a set of multiple switches interconnected together can be logically viewed as a large single switch. The large single switch provides service access points to customers' networks. Configuration faults in customer networks can result in loops spanning both provider and customer networks. This can result in broadcast storms. In order to protect provider's network from broadcast storms, loops that involve SAP ports need to be detected and broken.

The LBD can detect and break loops created on the service-access interface.

For a service-access interface, LBD can be enabled for a specific port or linkagg. LBD for service-access points allows shutting down only the specific interface of the link involved in the loop.

The switch can be configured to process LBD frames received from a different or remote system. The port of the remote system is shut down, rather than passing it as invalid LBD frames.

When loopback occurs, a trap is sent and the event is logged. The port which is shutdown due to LBD is automatically recovered if autorecovery-timer is set or the port can manually be enabled again when the problem is resolved.

In This Chapter

This chapter describes the LBD feature and how to configure it through the Command Line Interface (CLI). CLI commands are used in the configuration examples; for more details about the syntax of commands, see the *OmniSwitch AOS Release 8 CLI Reference Guide*. This chapter provides an overview of LBD and includes the following information:

- [“LBD Specifications” on page 8-2](#)
- [“Quick Steps for Configuring LBD” on page 8-4](#)
- [“LBD Overview” on page 8-6](#)
- [“Configuring LBD” on page 8-9](#)
- [“LBD for Service Access Interface” on page 8-10](#)
- [“Verifying the LBD Configuration” on page 8-14](#)

LBD Specifications

Platforms Supported	OmniSwitch 6860, 6860E
Ports Supported	There is no restriction on the type of ports on which the LBD can be enabled. But it is recommended LBD should be enabled on the edge ports.
Transmission Timer	The valid range is from 5 to 600 seconds.
Autorecovery Timer	The valid range is from 30 to 86400 seconds.

LBD Defaults

The following table shows LBD default values.

Parameter Description	Command	Default Value/Comments
LBD administrative state	loopback-detection	Disabled
LBD remote-origin administrative state	loopback-detection	Disabled
LBD status of a port	loopback-detection port	Disabled
Remote-origin LBD status of a port	loopback-detection port	Disabled
LBD service-access state	loopback-detection service-access	Disabled
Transmission time is the time period between LBD packet transmissions.	loopback-detection service-access	30 seconds
Autorecovery time is the time period in which the switch is recovered from the shutdown state.	loopback-detection autorecovery-timer	300 seconds

Quick Steps for Configuring LBD

The following steps provide a quick tutorial on how to configure LBD. Each step describes a specific operation and provides the CLI command syntax for performing that operation.

- 1 To enable the LBD protocol on a switch, use the **loopback-detection** command. For example:

```
-> loopback-detection enable
```

- 2 To enable the LBD protocol on a port, use the **loopback-detection port** command. For example:

```
-> loopback-detection port 1/1/1 enable
```

Note. Once the default LBD is enabled on the switch, the remote-origin LBD can be configured. It can be enabled globally or on a per port using the **loopback-detection** command with the remote-origin parameter. For example:

```
-> loopback-detection remote-origin enable
-> loopback-detection port 1/1/2 remote-origin enable
```

- 3 Configure the LBD transmission timer by using the **loopback-detection service-access** command. For example:

```
-> loopback-detection transmission-timer 200
```

- 4 To change the auto-recovery timer for Loopback detection, use the command **loopback-detection autorecovery-timer**. By default, the violation recovery time is 300 seconds.

```
-> loopback-detection autorecovery-timer 600
```

Note. *Optional.* Verify the LBD global configuration by entering the **loopback-detection autorecovery-timer** configuration command or verify the LBD configuration on a port by entering the **show loopback-detection port** command. For example:

```
-> show loopback-detection

Global LBD Status           : enabled,
Global Remote-origin LBD Status : disabled,
Global LBD Transmission Timer : 30 sec,
Global LBD Auto-recovery Timer : 999 sec,

-> show loopback-detection port 1/1/1
Global LBD Status           : enabled,
Global Remote-origin LBD Status : disabled,
Global LBD Transmission Timer : 30 sec,
Global LBD Auto-recovery Timer : 300 sec,
Port LBD Status             : disabled,
Port Remote-origin LBD Status : disabled,
Port LBD State               : Inactive,
Port LBD Type                : service-edge
```

To verify the LBD statistics of a port, use the **show loopback-detection statistics port** command. For example:

```
-> show loopback-detection statistics port 1/1/1
```

```
LBD Port Statistics
LBD Packet Send      : 1
Invalid LBD Packet Received : 0
Member of Link Aggregation : -
```

See the *OmniSwitch AOS Release 8 CLI Reference Guide* for information about the fields in this display.

LBD Overview

Loopback Detection (LBD) automatically detects and prevents L2 forwarding loops on a port. LBD operates in addition to STP which detects forwarding loops. When a loopback is detected, the port is disabled and goes into a shutdown state. A trap is sent and the event is logged.

When enabling and configuring Loopback Detection:

- Enable Loopback Detection globally on the switch.
- Enable Loopback Detection on edge port.

The switch periodically sends out LBD frame from loopback detection enabled port and concludes that the port is looped back if it receives the frame on any of the loop-back detection enabled ports.

Remote-origin LBD can be enabled and configured per port to process the LBD frames received from a remote system.

For service-access ports, LBD detects the loop for all the LBD edge ports involved.

Transmission Timer

Transmission timer is the time duration in seconds at which the port sends LBD frame on the link. When any port is getting blocked due to loopback detection, there will be no further transmission and receiving of any traffic on the blocked port. The port will be go to shutdown state.

By default, the transmission timer for loopback detection is 30 seconds.

Remote-origin LBD Overview

The remote-origin LBD processes the LBD frames originating from a remote system. The frame is processed and the receiving port is moved to shut down state.

The remote-origin LBD is functional, only if both default LBD and remote-origin LBD are enabled globally and at interface level. For the remote-origin LBD to operate:

- Default LBD must be enabled globally
- Remote-origin LBD must be enabled globally
- Default LBD must be configured on the interface
- Remote-origin LBD must be configured on the LBD enabled interface

The following scenario shows the operation of the remote-origin LBD functionality:

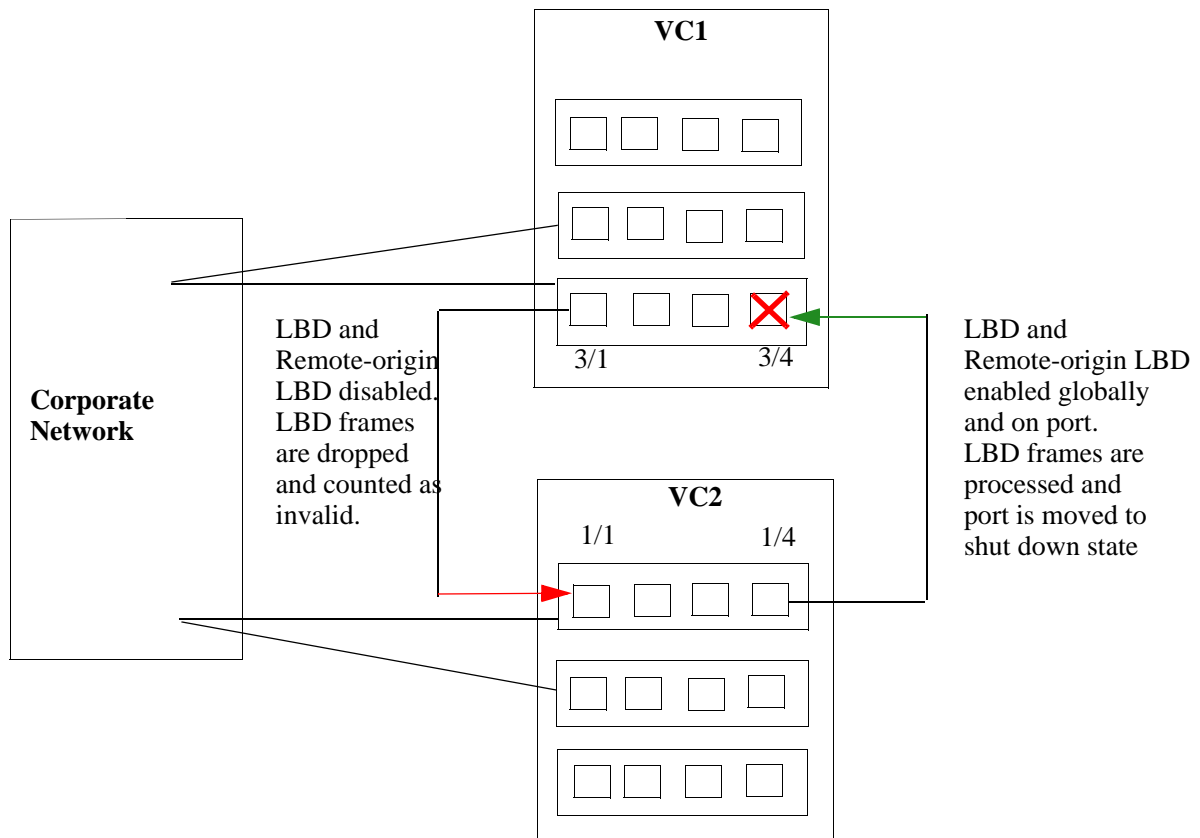

In the two systems VC1 and VC2, VC1 has both default LBD and remote origin LBD enabled globally and at the interface level (3/4). On VC2 only the default LBD is enabled globally and at interface level.

When LBD frame is transmitted from VC2 (1/4) to VC1 (3/4) the remote LBD frame is processed in VC1, the MAC address of the transmitting system is recorded and the receiving port (3/4) is moved to shut down.

When LBD frame is transmitted from VC1 (3/1) to VC2 (1/1) the LBD frame is dropped as the remote-origin LBD is not enabled.

Note. In case, if remote-origin LBD is enabled on both the systems, the system which receives the first remote LBD frame will shut down the port.

Interaction With Other Features

This section contains important information about how other OmniSwitch features interact with LBD. Refer to the specific chapter for each feature to get more detailed information about how to configure and use the feature.

Spanning Tree Protocol

- If the STP mode is set to Multiple Spanning Tree, Loopback Detection can only be enabled on interfaces where STP is disabled.
- LBD frame are sent untagged regardless of the spanning tree state on the port.

Link Aggregation

When loopback is detected on any one of the Linkagg port, all the ports of the linkagg will be shutdown due to loopback detection.

Configuring LBD

This section describes how to use Alcatel-Lucent Command Line Interface (CLI) commands to configure LBD on a switch.

- Enable LBD on a switch or port (see [“Enabling LBD” on page 8-9](#))
- Enable remote-origin LBD on a switch or port (see [“Enabling Remote-origin LBD” on page 8-9](#))
- Configure the LBD transmission timer (see [“Configuring the LBD Transmission Timer” on page 8-10](#))
- View the LBD statistics on a port (see [“Viewing LBD Statistics” on page 8-10](#))
- Recover a port from LBD shutdown (see [“Recovering a Port from LBD Shutdown” on page 8-10](#))
- Configuring Autorecovery-timer (see [“Configuring Autorecovery-timer for LBD shutdown ports” on page 8-10](#))
- Enable LBD on Service Access Interface (see [“Enabling LBD on Service-access Interface” on page 8-11](#))

Enabling LBD

By default, LBD is disabled on the switch. To enable LBD on a switch, use the **loopback-detection** command. For example, the following command enables LBD on a switch:

```
-> loopback-detection enable
```

Enabling LBD on a Port

By default, LBD is disabled on all switch ports. To enable LBD on a port, use the **loopback-detection port** command. For example, the following command enables LBD in chassis 1 on port 1 of slot 1:

```
-> loopback-detection port 1/1/1 enable
```

To enable LBD on multiple ports, specify a range of ports. For example:

```
-> loopback-detection port 1/1/1-8 enable
```

Enabling Remote-origin LBD

By default, remote-origin LBD is disabled on the switch. To enable remote-origin LBD on a switch, use the **loopback-detection** command with the **remote-origin** parameter. For example, the following command enables remote-origin LBD on a switch:

```
-> loopback-detection remote-origin enable
```

Enabling Remote-origin LBD on a port

By default, remote-origin LBD is disabled on all switch ports. To enable remote-origin LBD on a port, use the **loopback-detection port** command with the **remote-origin** parameter. For example, the following command enables remote-origin LBD in chassis 3 on port 1 of slot 1:

```
-> loopback-detection port 3/1/1 remote-origin enable
```

To enable remote-origin LBD on multiple ports, specify a range of ports. For example:

```
-> loopback-detection port 3/1/1-8 remote-origin enable
```

Note. See [“Remote-origin LBD Overview”](#) on page 8-6 for more details.

Configuring the LBD Transmission Timer

To configure the transmission time period between LBD packet transmissions, use the [loopback-detection service-access](#) command. For example:

```
-> loopback-detection transmission-timer 200
```

Viewing LBD Statistics

To view the LBD statistics on a specific port, use the [show loopback-detection statistics port](#) command. For example, to view the statistics for port 1 on slot 1 of chassis 1, enter:

```
-> show loopback-detection statistics port 1/1/1
```

Recovering a Port from LBD Shutdown

To bring a port out of the shutdown state, use the [clear violation](#) command. For example, to bring the chassis 1, port 5 on slot 1 out of the shutdown state, enter:

```
-> clear port 1/1/5
```

To bring multiple ports out of the shutdown state, enter:

```
-> clear port 1/5/5-10
```

Configuring Autorecovery-timer for LBD shutdown ports

The port which is shutdown due to LBD can be automatically recovered if autorecovery-timer is set for the switch. To set the autorecovery-timer, use the [loopback-detection autorecovery-timer](#) command. For example, to set a autorecovery-timer of 200 sec for the switch, enter:

```
-> loopback-detection autorecovery-timer 200
```

LBD for Service Access Interface

A provider network with a set of multiple switches interconnected together can be logically viewed as a large single switch. The large single switch provides service access points to customers' networks. Configuration faults in customer networks can result in loops spanning both provider and customer networks. This can result in broadcast storms. In order to protect provider's network from broadcast storms, loops that involve SAP ports need to be detected and broken.

The LBD can detect and break loops created on the service-access interface.

For a service-access interface, LBD can be enabled for a specific port or linkagg. LBD for service-access points allows shutting down only the specific interface of the link involved in the loop.

Enabling LBD on Service-access Interface

By default, LBD is disabled on all service-access ports. To enable LBD on a service-access port, use the **loopback-detection service-access** command. For example, the following command enables LBD on chassis 1, port 1 of slot 1:

```
-> loopback-detection service-access port 1/1/1 enable
```

LBD can be configured for linkagg only if the linkagg is of the type service-access. For example, the following command enables LBD on linkagg 1:

```
-> loopback-detection service-access linkagg 1 enable
```

Few things to be considered while configuring LBD on linkagg:

- The link aggregate must be formed by ports with same path cost.
- LBD cannot be configured on linkagg which has member ports running LBD configuration and vice versa.
- When a linkagg is in violation or shutdown state, the member ports cannot be deleted from the linkagg.

Note. Before configuring the LBD using the “service-access” option the port or linkagg must be configured for service access. Use the **service access** command, to configure the port or linkagg for service access. When LBD is enabled on ports without the 'service-access' keyword, the LBD behaves as normal LBD feature.

LBD Packet Processing Mechanism for LBD Service Access Ports

The LBD packets on the service access ports are processed as follows:

- 1** If Virtual Private (VP) or Virtual Forwarding Instance (VFI) information is present in the packet driver, then the LBD packet is processed else the packet is dropped.
- 2** The initiator session identifier (ISID) of the packet is extracted from the VP or VFI information and compared with the LBD packet TLV ISID. If the ISID does not match, the packet is dropped.
- 3** If ISID matches, then the LBD packet TLV path cost is compared with the receiving LBD service access port path cost. If the LBD path cost is lesser, the receiving access port is shut down. If LBD path cost is higher, then the packet is dropped.
- 4** If path costs are equal, then LBD packet bridge MAC and receiving access port bridge MAC is compared. If LBD packet bridge MAC is lesser, then the receiving access port is shutdown. If LBD Bridge MAC is higher, then the packet is dropped.
- 5** If LBD packet bridge MAC and receiving access port bridge MAC are same (that is, same switch), then LBD packet port ID and access port ID is compared. If LBD packet port ID is lesser, then the receiving access port is shutdown. If LBD packet port ID is higher, then the packet is dropped.

Sample Scenarios

Scenario 1

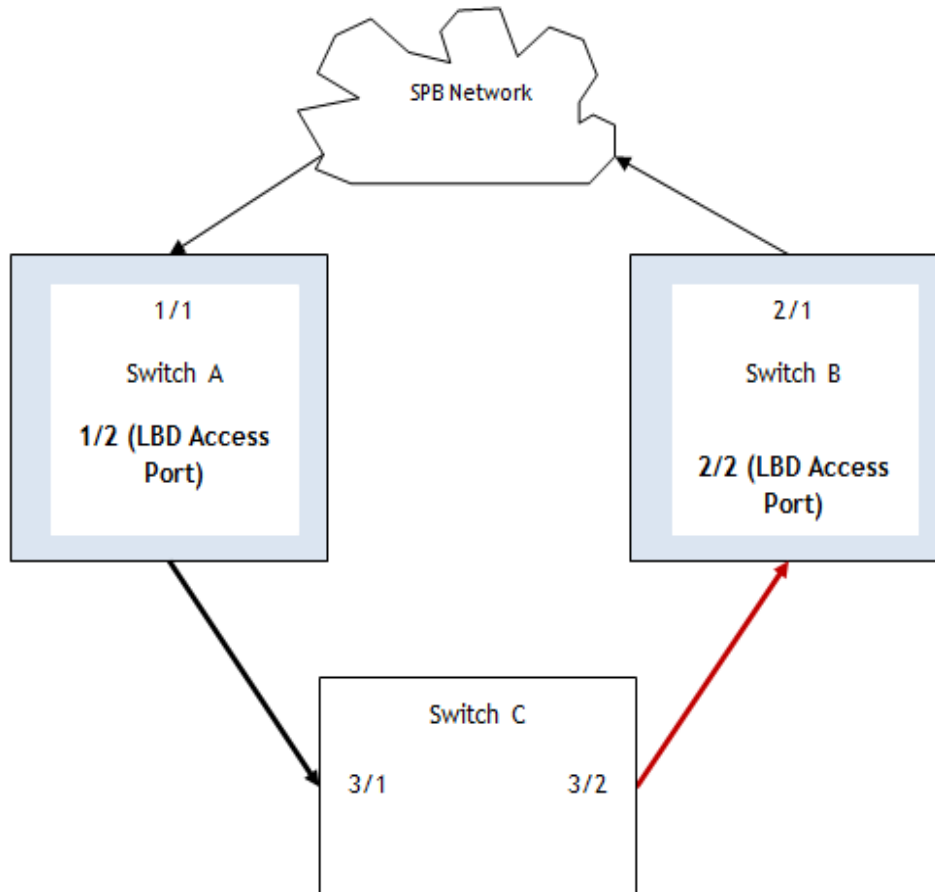

■ Link shutdown

- Switch A and B are AOS switches running loopback-detection.
- Switch C is a legacy switch or a non AOS switch or a hub.
- 1/2 and 2/2 are SAP ports having same ISID and path cost.
- Loopback-detection is enabled with option 'service-access' on ports 1/2 and 2/2; traffic loops through 1/2 and 2/2.
- Port 2/2 is shutdown in case B has higher bridge identifier, since 1/2 and 2/2 has equal path costs.

Scenario 2

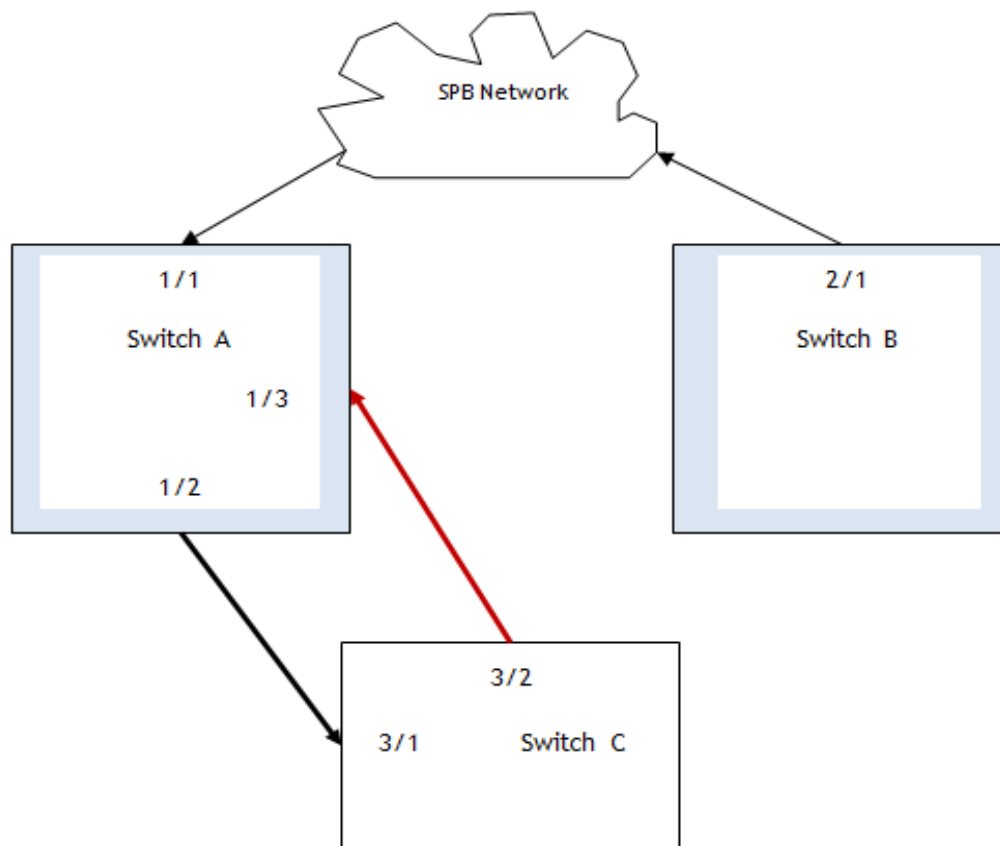

■ Link shutdown

- Switch A and B are AOS switches running loopback-detection.
- Switch C is a legacy switch or a non AOS switch or a hub.
- 1/2 and 1/3 are SAP ports having same ISID and path cost.
- Loopback-detection is enabled with option 'service-access' on ports 1/2 and 1/3; traffic loops through 1/2 and 1/3.
- Port 1/3 is shutdown as the interface has higher port identifier, since 1/2 and 1/3 has equal path costs.

Verifying the LBD Configuration

To display LBD configuration and statistics information, use the **show** commands listed below:

loopback-detection autorecovery-timer Displays the global LBD configuration information for the switch.

show loopback-detection port Displays LBD configuration information for all ports on the switch.

show loopback-detection statistics port Displays LBD statistics information for a specific port on the switch.

For more information about the resulting display from these commands, see the *OmniSwitch AOS Release 8 CLI Reference Guide*.

9 Configuring Static Link Aggregation

Alcatel-Lucent's static link aggregation software allows you to combine several physical links into one large virtual link known as a link aggregation *group*. Using link aggregation provides the following benefits:

- **Scalability.** It is possible to configure a maximum number of link aggregation groups as mentioned in the “[Static Link Aggregation Specifications](#)” table that consist of multiple Ethernet links.
- **Reliability.** A link aggregate can operate even if one of the physical links, that is part of the link aggregate group, gets disabled.
- **Ease of Migration.** Link aggregation can ease the transition from 100-Mbps Ethernet backbones to Gigabit or 10-Gigabit Ethernet backbones.

In This Chapter

This chapter describes the basic components of static link aggregation and how to configure them through the Command Line Interface (CLI). CLI commands are used in the configuration examples; for more details about the syntax of commands, see the *OmniSwitch AOS Release 8 CLI Reference Guide*.

Configuration procedures described in this chapter include:

- “[Configuring Static Link Aggregation Groups](#)” .
- “[Adding and Deleting Ports in a Static Aggregate Group](#)”.
- “[Modifying Static Aggregation Group Parameters](#)”.

Note. You can also configure and monitor static link aggregation with WebView, Alcatel-Lucent's embedded web-based device management application. WebView is an interactive and easy-to-use GUI that can be launched from OmniVista or a web browser. Please refer to the [WebView](#) online documentation for more information on configuring and monitoring static link aggregation with WebView.

Static Link Aggregation Specifications

The table below lists specifications for static groups.

Platforms Supported	OmniSwitch 6860, 6860E
Maximum number of link aggregation groups	128
Maximum number of links per group supported	16

Static Link Aggregation Default Values

The table below lists default values and the commands to modify them for static aggregate groups.

Parameter Description	Command	Default Value/Comments
Administrative State	<code>linkagg static agg admin-state</code>	enabled
Group Name	<code>linkagg static agg name</code>	No name configured

Quick Steps for Configuring Static Link Aggregation

Follow the steps below for a quick tutorial on configuring a static aggregate link between two switches. Additional information on how to configure each command is given in the subsections that follow.

1 Create the static aggregate link on the local switch with the **linkagg static agg size** command. For example:

```
-> linkagg static agg 1 size 4
```

2 Assign all the necessary ports with the **linkagg static port agg** command. For example:

```
-> linkagg static port 1/1/1-4 agg 1
```

3 Create a VLAN for this static link aggregate group with the **vlan members** command. For example:

```
-> vlan 10 members port 1
```

4 Create the equivalent static aggregate link on the *remote switch* with the **linkagg static agg size** command. For example:

```
-> linkagg static agg 1 size 4
```

5 Assign all the necessary ports with the **linkagg static port agg** command. For example:

```
-> linkagg static port 1/1/9-12 agg 1
```

6 Create a VLAN for this static link aggregate group with the **vlan members** command. For example:

```
-> vlan 10 members default 1
```

Note. *Optional.* You can verify your static link aggregation settings with the **linkagg range** command along with the **agg** keyword and aggregate group ID. For example:

```
-> show linkagg agg 1
```

```
Static Aggregate
SNMP Id           : 40000001,
Aggregate Number  : 1,
SNMP Descriptor   : Omnichannel Aggregate Number 1 ref 40000001 size
4,
Name              : ,
Admin State       : ENABLED,
Operational State : UP,
Aggregate Size    : 4,
Number of Selected Ports : 4,
Number of Reserved Ports : 4,
Number of Attached Ports : 4,
Primary Port      : 1/1/1
```

You can also use the **show linkagg port** command to display information on specific ports. See “[Displaying Static Link Aggregation Configuration and Statistics](#)” on page 9-11 for more information on the **show** commands.

An example of what these commands look like entered sequentially on the command line on the local switch:

```
-> linkagg static agg 1 size 4
-> linkagg static port 1/1/1-4 agg 1
-> vlan 10 port default 1
```

And an example of what these commands look like entered sequentially on the command line on the remote switch:

```
-> linkagg static agg 1 size 4
-> linkagg static port 1/1/9-12 agg 1
-> vlan 10 port default 1
```

Static Link Aggregation Overview

Link aggregation allows you to combine multiple physical connections into large virtual connections known as link aggregation *groups*.

You can create Virtual LANs (VLANs), 802.1Q framing, configure Quality of Service (QoS) conditions, and other networking features on link aggregation groups because the OmniSwitch AOS software treats these virtual links just like physical links. (See [“Relationship to Other Features”](#) on page 9-5 for more information on how link aggregation interacts with other software features.)

Load balancing for Layer 2 non-IP packets is on a MAC address basis. However when IP packets are transmitted, the balancing algorithm uses the IP address. Ports must be of the same speed within the same link aggregate group.

Alcatel-Lucent’s link aggregation software allows you to configure the following two different types of link aggregation groups:

- Static link aggregate groups
- Dynamic link aggregate groups

This chapter describes static link aggregation. For information on dynamic link aggregation, please refer to [Chapter 10, “Configuring Dynamic Link Aggregation.”](#)

Static Link Aggregation Operation

Static link aggregate groups are virtual links between two nodes consisting multiple fixed physical links.

The figure below shows a static aggregate group that has been configured between Switch A and Switch B. The static aggregate group links multiple ports on Switch A to multiple ports on Switch B. The network administrator has created a separate VLAN for this group so users can use this high speed link.

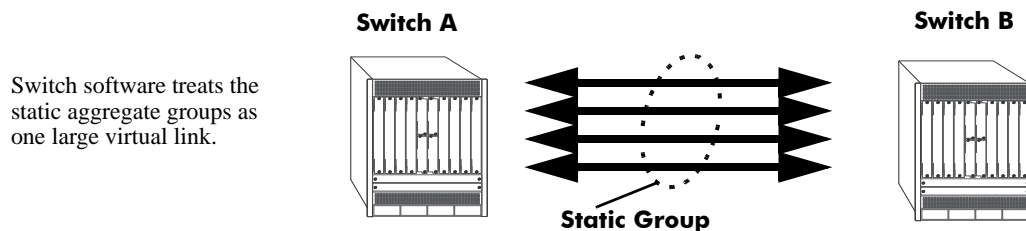

Example of a Static Link Aggregate Group Network

See [“Configuring Static Link Aggregation Groups”](#) on page 9-6 for information on using Command Line Interface (CLI) commands to configure static aggregate groups and see [“Displaying Static Link Aggregation Configuration and Statistics”](#) on page 9-11 for information on using CLI to monitor static aggregate groups.

Relationship to Other Features

Link aggregation groups are supported by other switch software features. The following features have CLI commands or command parameters that support link aggregation:

- **VLANs.** For more information on VLANs see [Chapter 4, “Configuring VLANs.”](#)
- **802.1Q.** For more information on configuring and monitoring 802.1Q see [Chapter 4, “Configuring VLANs.”](#)

- **Spanning Tree.** For more information on Spanning Tree see [Chapter 9, “Configuring Static Link Aggregation.”](#)

Note. See [“Application Example” on page 9-10](#) for tutorials on using link aggregation with other features.

Configuring Static Link Aggregation Groups

This section describes how to use OmniSwitch Command Line Interface (CLI) commands to configure static link aggregate groups. See [“Configuring Mandatory Static Link Aggregate Parameters” on page 9-6](#) for more information.

Note. See [“Quick Steps for Configuring Static Link Aggregation” on page 9-3](#) for a brief tutorial on configuring these mandatory parameters.

Alcatel-Lucent’s link aggregation software is preconfigured with the default values for static aggregate groups as shown in the table in [“Static Link Aggregation Default Values” on page 9-2](#). If you need to modify any of these parameters, please see [“Modifying Static Aggregation Group Parameters” on page 9-9](#) for more information.

Note. See the “Link Aggregation Commands” chapter in the *OmniSwitch AOS Release 8 CLI Reference Guide* for complete documentation of CLI commands for link aggregation.

Configuring Mandatory Static Link Aggregate Parameters

When configuring static link aggregates on a switch you must perform the following steps:

- 1 Create the Static Aggregate Group on the Local and Remote Switches.** To create a static aggregate group use the **linkagg static agg size** command, which is described in [“Creating and Deleting a Static Link Aggregate Group” on page 9-7](#).
- 2 Assign Ports on the Local and Remote Switches to the Static Aggregate Group.** To assign ports to the static aggregate group you use the **linkagg static port agg** command, which is described in [“Adding and Deleting Ports in a Static Aggregate Group” on page 9-7](#).

Note. Depending on the needs of your network you need to configure additional parameters. Commands to configure optional static aggregate parameters are described in [“Modifying Static Aggregation Group Parameters” on page 9-9](#).

Creating and Deleting a Static Link Aggregate Group

The following subsections describe how to create and delete static link aggregate groups with the [linkagg static agg size](#) command.

Creating a Static Aggregate Group

To create a static aggregate group on a switch, enter **linkagg static agg** followed by the user-specified aggregate number, **size**, and the number of links in the static aggregate group.

For example, to create static aggregate group 5 that consists of eight links, on a switch, enter:

```
-> linkagg static agg 5 size 8
```

As an option you can also specify a name and/or the administrative status of the group by entering **linkagg static agg** followed by the user-specified aggregate number, **size**, the number of links in the static aggregate group, **name**, the optional name, **admin-state**, and either **enable** or **disable** (the default is **enable**).

For example, to create static aggregate group 5 called “static1” consisting of eight links that is administratively disabled enter:

```
-> linkagg static agg 5 size 8 name static1 admin-state disable
```

Deleting a Static Aggregate Group

To delete a static aggregation group from a switch use the **no** form of the [linkagg static agg size](#) command by entering **no linkagg static agg** followed by the number that identifies the group. For example, to remove static aggregate group 5 from the switch configuration, enter:

```
-> no linkagg static agg 5
```

Note. You must delete any attached ports with the [linkagg static port agg](#) command before you can delete a static link aggregate group.

Adding and Deleting Ports in a Static Aggregate Group

The following subsections describe how to add and delete ports in a static aggregate group with the [linkagg static port agg](#) command.

Adding Ports to a Static Aggregate Group

The number of ports assigned in a static aggregate group can be less than or equal to the maximum size you specified in the [linkagg static agg size](#) command. To assign a port to a static aggregate group you use the [linkagg static port agg](#) command by entering **linkagg static port** followed by the port number, **agg**, and the number or ID of the static aggregate group.

For example, to assign ports 1, 2, and 3 to static aggregate group 10 (which has a size of 4), enter:

```
-> linkagg static port 1/1/1 agg 10
-> linkagg static port 1/1/2 agg 10
-> linkagg static port 1/1/3 agg 10
```

Note. A port belongs to only one aggregate group.

For example, to assign port 1/1/4 to static aggregate group 10, enter:

```
-> linkagg static port 1/1/4 agg 10
```

Removing Ports from a Static Aggregate Group

To remove a port from a static aggregate group you use the **no** form of the [linkagg static port agg](#) command by entering **no linkagg static port** followed by the port number. For example:

```
-> no linkagg static port 1/1/4
```

Modifying Static Aggregation Group Parameters

This section describes how to modify the following static aggregate group parameters:

- Static aggregate group name (see “[Modifying the Static Aggregate Group Name](#)” on page 9-9)
- Static aggregate group administrative state (see “[Modifying the Static Aggregate Group Administrative State](#)” on page 9-9)

Modifying the Static Aggregate Group Name

The following subsections describe how to modify the name of the static aggregate group with the [linkagg static agg name](#) command.

Creating a Static Aggregate Group Name

To create a name for a static aggregate group by entering [linkagg static agg](#) followed by the number of the static aggregate group, **name**, and the user-specified name of the group. For example, to configure static aggregate group 4 with the name “Finance” , enter:

```
-> linkagg static agg 4 name Finance
```

Note. If you want to specify spaces within a name for a static aggregate group the name must be specified within quotes (for example, “Static Aggregate Group 4”).

Deleting a Static Aggregate Group Name

To remove a name from a static aggregate group, use the **no** form of the [linkagg static agg name](#) command by entering **no linkagg static agg** followed by the number of the static aggregate group and **name**. For example, to remove any user-specified name from static aggregate group 4, enter:

```
-> no linkagg static agg 4 name
```

Modifying the Static Aggregate Group Administrative State

By default, the administrative state for a static aggregate group is enabled. The following subsections describe how to enable and disable the administrative state with the [linkagg static agg admin-state](#) command.

Enabling the Static Aggregate Group Administrative State

To enable a static aggregate group, enter [linkagg static agg](#) followed by the number of the group and **admin-state enable**. For example, to enable static aggregate group 1, enter:

```
-> linkagg static agg 1 admin-state enable
```

Disabling the Static Aggregate Group Administrative State

To disable a static aggregate group by entering [linkagg static agg](#) followed by the number of the group and **admin-state disable**. For example, to disable static aggregate group 1, enter:

```
-> linkagg static agg 1 admin-state disable
```

Application Example

Static link aggregation groups are treated by the switch software the same way it treats individual physical ports. This section demonstrates this by providing a sample network configuration that uses static link aggregation along with other software features. In addition, a tutorial is provided that shows how to configure this sample network using Command Line Interface (CLI) commands.

The figure below shows VLAN 8, which has been configured on static aggregate 1 and uses 802.1Q tagging. The actual physical links connect ports 4/1/1, 4/1/2, 4/1/3, and 4/1/4 on Switch A to port 2/1/41, 2/1/42, 2/1/43, and 2/1/44 on Switch B.

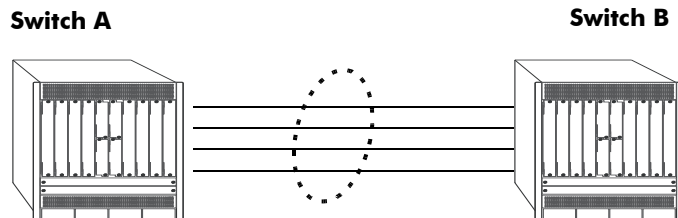

Static Aggregate Group 1
VLAN 8 with 802.1Q tagging has been configured to use this group.

Sample Network Using Static Link Aggregation

Follow the steps below to configure this network:

Note. Only the steps to configure the local (i.e., Switch A) switch are provided here since the steps to configure the remote (i.e., Switch B) switch are similar.

- 1 Configure static aggregate group 1 by entering **linkagg static agg 1 size 4** as shown below:

```
-> linkagg static agg 1 size 4
```
- 2 Assign ports 4/1/1, 4/1/2, 4/1/3, and 4/1/4 to static aggregate group 1 by entering:

```
-> linkagg static port 4/1/1-4 agg 1
```
- 3 Create VLAN 8 by entering:

```
-> vlan 8
```
- 4 Configure 802.1Q tagging with a tagging ID of 8 on static aggregate group 1 (on VLAN 8) by entering:

```
-> vlan 8 members linkagg 1 tagged
```
- 5 Repeat steps 1 through 4 on Switch B. Substitute the port numbers of the commands with the appropriate port numbers of Switch B.

Displaying Static Link Aggregation Configuration and Statistics

You can use Command Line Interface (CLI) **show** commands to display the current configuration and statistics of link aggregation. These commands include the following:

- linkagg range** Displays information on link aggregation groups.
- show linkagg port** Displays information on link aggregation ports.

When you use the **show linkagg** command without specifying the link aggregation group number and when you use the **show linkagg port** command without specifying the port number these commands provide a “global” view of switch-wide link aggregate group and link aggregate port information, respectively.

For example, to display global statistics on all link aggregate groups (both static and dynamic), enter:

```
-> show linkagg
```

Number	Aggregate	SNMP Id	Size	Admin State	Oper State	Att/Sel	Ports
1	Static	40000001	4	ENABLED	DOWN	0	0
2	Static	40000002	8	ENABLED	DOWN	0	0
10	Dynamic	40000010	8	ENABLED	DOWN	0	0

For example, to display global statistics on all ports associated with link aggregate groups (both static and dynamic), enter:

```
-> show linkagg port
```

A screen similar to the following would be displayed:

Chassis/Slot/Port	Aggregate	SNMP Id	Status	Agg Oper	Link Prim
2/1/1	Static	2001	ATTACHED	1 UP	UP YES

When you use the **show linkagg agg** command with the link aggregation group number and when you use the **show linkagg port** command with the port number these commands provide detailed views of link aggregate group and link aggregate port information, respectively. These detailed views provide excellent tools for diagnosing and troubleshooting problems.

For example, to display detailed statistics for port 4/1/1 that is attached to static link aggregate group 1, enter:

```
-> show linkagg port 4/1/1
```

A screen similar to the following would be displayed:

```
Static Aggregable Port
  SNMP Id                : 2001,
  Chassis/Slot/Port      : 4/1/1,
  Administrative State   : ENABLED,
  Operational State      : UP,
  Port State              : ATTACHED,
```

```
Link State           : UP,  
Selected Agg Number : 1,  
Port position in the aggregate : 0,  
Primary port        : YES
```

Note. See the “Link Aggregation Commands” chapter in the *OmniSwitch AOS Release 8 CLI Reference Guide* for complete documentation of **show** commands for link aggregation.

10 Configuring Dynamic Link Aggregation

Alcatel-Lucent's dynamic link aggregation software allows you to combine several physical links into one large virtual link known as a link aggregation *group*. Using link aggregation provides the following benefits:

- **Scalability.** It is possible to configure up to a maximum number of link aggregation groups as mentioned in [“Dynamic Link Aggregation Specifications” on page 10-2](#), that consist of multiple Ethernet links
- **Reliability.** If one of the physical links in a link aggregate group goes down (unless it is the last one) the link aggregate group can still operate.
- **Ease of Migration.** Link aggregation can ease the transition from 100-Mbps Ethernet backbones to Gigabit or 10-Gigabit Ethernet backbones.

In This Chapter

This chapter describes the basic components of dynamic link aggregation and how to configure them through the Command Line Interface (CLI). CLI commands are used in the configuration examples; for more details about the syntax of commands, see the *OmniSwitch AOS Release 8 CLI Reference Guide*.

Configuration procedures described in this chapter include:

- Configuring dynamic link aggregation groups on [“Configuring Dynamic Link Aggregate Groups” on page 10-8](#).
- Configuring ports so they can be aggregated in dynamic link aggregation groups on [“Configuring Ports to Join and Removing Ports in a Dynamic Aggregate Group” on page 10-10](#).
- Modifying dynamic link aggregation parameters on [“Modifying Dynamic Link Aggregate Group Parameters” on page 10-12](#).

Note. You can also configure and monitor dynamic link aggregation with WebView, Alcatel-Lucent's embedded Web-based device management application. WebView is an interactive and easy-to-use GUI that can be launched from OmniVista or a Web browser. Please refer to the WebView online documentation for more information on configuring and monitoring dynamic link aggregation with WebView.

Dynamic Link Aggregation Specifications

The table below lists specifications for dynamic aggregation groups and ports:

Platforms Supported	OmniSwitch 6860, 6860E
IEEE Specifications Supported	802.3ad/802.1ax — Aggregation of Multiple Link Segments
Maximum number of link aggregation groups	128
Maximum number of ports per link aggregate	16
Number of ports per group when maximum groups are configured	2
Maximum number of linkagg ports per system	256

Dynamic Link Aggregation Default Values

The table below lists default values for dynamic aggregate groups.

Parameter Description	Command	Default Value/Comments
Group Administrative State	<code>linkagg lacp agg admin-state</code>	enabled
Group Name	<code>linkagg lacp agg name</code>	No name configured
Group Actor Administrative Key	<code>linkagg lacp agg actor admin-key</code>	0
Group Actor System Priority	<code>linkagg lacp agg actor system-priority</code>	0
Group Actor System ID	<code>linkagg lacp agg actor system-id</code>	00:00:00:00:00:00
Group Partner System ID	<code>linkagg lacp agg partner system-id</code>	00:00:00:00:00:00
Group Partner System Priority	<code>linkagg lacp agg partner system-priority</code>	0
Group Partner Administrative Key	<code>linkagg lacp agg partner admin-key</code>	0
Actor Port Administrative State	<code>linkagg lacp agg admin-state</code>	active timeout aggregate
Actor Port System ID	<code>linkagg lacp agg actor system-id</code>	00:00:00:00:00:00
Partner Port System Administrative State	<code>linkagg lacp agg partner admin-state</code>	active timeout aggregate
Partner Port Admin System ID	<code>linkagg lacp port partner admin system-priority</code>	00:00:00:00:00:00
Partner Port Administrative Key	<code>linkagg lacp agg partner admin-key</code>	0
Partner Port Admin System Priority	<code>linkagg lacp agg partner system-priority</code>	0
Actor Port Priority	<code>linkagg lacp port actor port priority</code>	0
Partner Port Administrative Port	<code>linkagg lacp port partner admin-port</code>	0
Partner Port Priority	<code>linkagg lacp port partner admin port-priority</code>	0

Quick Steps for Configuring Dynamic Link Aggregation

Follow the steps below for a quick tutorial on configuring a dynamic aggregate link between two switches. Additional information on how to configure each command is given in the subsections that follow.

- 1** Create the dynamic aggregate group on the local (actor) switch with the **linkagg lacp agg size** command as shown below:

```
-> linkagg lacp agg 2 size 8 actor admin-key 5
```

- 2** Configure ports (the number of ports must be less than or equal to the size value set in step 1) with the same actor administrative key (which allows them to be aggregated) with the **linkagg lacp agg actor admin-key** command. For example:

```
-> linkagg lacp port 1/1/1 actor admin-key 5
-> linkagg lacp port 1/1/4 actor admin-key 5
-> linkagg lacp port 3/1/3 actor admin-key 5
-> linkagg lacp port 5/1/4 actor admin-key 5
-> linkagg lacp port 6/1/1-2 actor admin-key 5
-> linkagg lacp port 7/1/3 actor admin-key 5
-> linkagg lacp port 8/1/1 actor admin-key 5
```

- 3** Create a VLAN for this dynamic link aggregate group with the **vlan** command. For example:

```
-> vlan 2 members linkagg 2 untagged
```

- 4** Create the equivalent dynamic aggregate group on the remote (partner) switch with the **linkagg lacp agg size** command as shown below:

```
-> linkagg lacp agg 2 size 8 actor admin-key 5
```

- 5** Configure ports (the number of ports must be less than or equal to the size value set in step 4) with the same actor administrative key (which allows them to be aggregated) with the **linkagg lacp agg actor admin-key** command. For example:

```
-> linkagg lacp port 1/2/1 actor admin-key 5
-> linkagg lacp port 1/3/1 actor admin-key 5
-> linkagg lacp port 3/1/3 actor admin-key 5
-> linkagg lacp port 3/1/6 actor admin-key 5
-> linkagg lacp port 5/1/1 actor admin-key 5
-> linkagg lacp port 5/1/6 actor admin-key 5
-> linkagg lacp port 8/1/1 actor admin-key 5
-> linkagg lacp port 8/1/3 actor admin-key 5
```

- 6** Create a VLAN for this dynamic link aggregate group with the **vlan** command. For example:

```
-> vlan 2 members linkagg 2
```

Note. As an option, you can verify your dynamic aggregation group settings with the **linkagg range** command on either the actor or the partner switch. For example:

```
-> show linkagg agg 2
Dynamic Aggregate
SNMP Id           : 40000002,
Aggregate Number  : 2,
SNMP Descriptor   : Dynamic Aggregate Number 2 ref 40000002 size 8,
Name              : ,
Admin State       : ENABLED,
Operational State : UP,
Aggregate Size    : 8,
Number of Selected Ports : 8,
Number of Reserved Ports : 8,
Number of Attached Ports : 8,
Primary Port      : 1/1/1,
LACP
MACAddress        : [00:1f:cc:00:00:00],
Actor System Id   : [00:20:da:81:d5:b0],
Actor System Priority : 0,
Actor Admin Key   : 5,
Actor Oper Key    : 0,
Partner System Id : [00:20:da:81:d5:b1],
Partner System Priority : 0,
Partner Admin Key : 5,
Partner Oper Key  : 0
```

You can also use the **show linkagg port** port command to display information on specific ports. See “[Displaying Dynamic Link Aggregation Configuration and Statistics](#)” on page 10-29 for more information on **show** commands.

An example of what these commands look like entered sequentially on the command line on the actor switch:

```
-> linkagg lacp agg 2 size 8 actor admin-key 5
-> linkagg lacp port 1/1/1 actor admin-key 5
-> linkagg lacp port 1/1/4 actor admin-key 5
-> linkagg lacp port 3/1/3 actor admin-key 5
-> linkagg lacp port 5/1/4 actor admin-key 5
-> linkagg lacp port 6/1/1-2 actor admin-key 5
-> linkagg lacp port 7/1/3 actor admin-key 5
-> linkagg lacp port 8/1/1 actor admin-key 5
-> vlan 2 members linkagg 2 untagged
```

An example of what these commands look like entered sequentially on the command line on the partner switch:

```
-> linkagg lacp agg 2 size 8 actor admin-key 5
-> linkagg lacp port 1/2/1 actor admin-key 5
-> linkagg lacp port 1/3/1 actor admin-key 5
-> linkagg lacp port 1/3/3 actor admin-key 5
-> linkagg lacp port 3/1/6 actor admin-key 5
-> linkagg lacp port 5/1/1 actor admin-key 5
-> linkagg lacp port 5/1/6 actor admin-key 5
-> linkagg lacp port 8/1/1 actor admin-key 5
-> linkagg lacp port 8/1/3 actor admin-key 5
-> vlan 2 members linkagg 2 untagged
```

Dynamic Link Aggregation Overview

Link aggregation allows you to combine multiple physical connections into large virtual connections known as link aggregation *groups*. Each group can consist of multiple Ethernet links.

You can create Virtual LANs (VLANs), 802.1Q framing, configure Quality of Service (QoS) conditions, and other networking features on link aggregation groups because switch software treats these virtual links just like physical links. (See [“Relationship to Other Features”](#) on page 10-8 for more information on how link aggregation interacts with other software features.)

Link aggregation groups are identified by unique MAC addresses, which are created by the switch but can be modified by the user at any time. Load balancing for Layer 2 non-IP packets is on a MAC address basis and for IP packets the balancing algorithm uses the IP address as well. Ports must be of the same speed within the same aggregate group.

Alcatel-Lucent’s link aggregation software allows you to configure the following two different types of link aggregation groups:

- Static link aggregate groups
- Dynamic link aggregate groups

This chapter describes dynamic link aggregation. For information on static link aggregation, please refer to [Chapter 9, “Configuring Static Link Aggregation.”](#)

Dynamic Link Aggregation Operation

Dynamic aggregate groups are virtual links between two nodes consisting of multiple 10-Mbps, 100-Mbps, or 1-or 10-Gbps fixed physical links. Dynamic aggregate groups use the standard IEEE 802.3ad Link Aggregation Control Protocol (LACP) to dynamically establish the best possible configuration for the group. This task is accomplished by special Link Aggregation Control Protocol Data Unit (LACPDU) frames that are sent and received by switches on both sides of the link to monitor and maintain the dynamic aggregate group.

The figure on the following page shows a dynamic aggregate group that has been configured between Switch A and Switch B. The dynamic aggregate group links four ports on Switch A to four ports on Switch B.

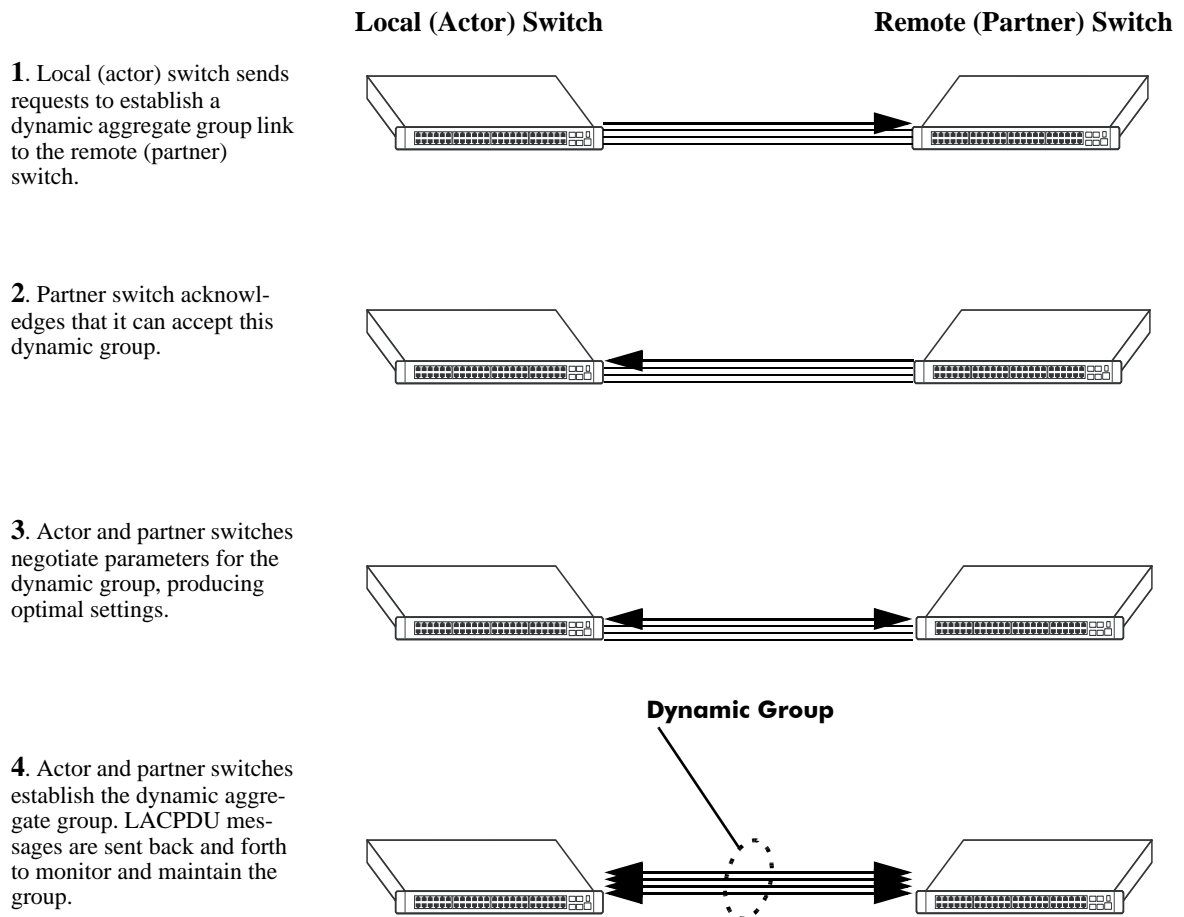

Example of a Dynamic Aggregate Group Network

See [“Configuring Dynamic Link Aggregate Groups”](#) on page 10-8 for information on using Command Line Interface (CLI) commands to configure dynamic aggregate groups and see [“Displaying Dynamic Link Aggregation Configuration and Statistics”](#) on page 10-29 for information on using the CLI to monitor dynamic aggregate groups.

Relationship to Other Features

Link aggregation groups are supported by other switch software features. For example, you can configure 802.1Q tagging on link aggregation groups in addition to configuring it on individual ports. The following features have CLI commands or command parameters that support link aggregation:

- **VLANs.** For more information on VLANs, see [Chapter 4, “Configuring VLANs.”](#)
- **802.1Q.** For more information on configuring and monitoring 802.1Q, see [Chapter 4, “Configuring VLANs.”](#)
- **Spanning Tree.** For more information on Spanning Tree, see [Chapter 6, “Configuring Spanning Tree Parameters.”](#)

Note. See [“Application Examples” on page 10-26](#) for tutorials on using link aggregation with other features.

Configuring Dynamic Link Aggregate Groups

This section describes how to use Alcatel-Lucent’s Command Line Interface (CLI) commands to create, modify, and delete dynamic aggregate groups. See [“Configuring Mandatory Dynamic Link Aggregate Parameters” on page 10-9](#) for more information.

Note. See [“Quick Steps for Configuring Dynamic Link Aggregation” on page 10-4](#) for a brief tutorial on configuring these mandatory parameters.

Alcatel-Lucent’s link aggregation software is preconfigured with the default values for dynamic aggregate groups and ports shown in the table in [“Dynamic Link Aggregation Default Values” on page 10-3](#). For most configurations, using only the steps described in [“Creating and Deleting a Dynamic Aggregate Group” on page 10-9](#) is necessary to configure a dynamic link aggregate group. However, if you need to modify any of the parameters listed in the table on [page 10-3](#), please see [“Modifying Dynamic Link Aggregate Group Parameters” on page 10-12](#) for more information.

Note. See the [“Link Aggregation Commands”](#) chapter in the *OmniSwitch AOS Release 8 CLI Reference Guide* for complete documentation of **show** commands for link aggregation.

Configuring Mandatory Dynamic Link Aggregate Parameters

When configuring LACP link aggregates on a switch you must perform the following steps:

1 Create the Dynamic Aggregate Groups on the Local (Actor) and Remote (Partner) Switches. To create a dynamic aggregate group use the `linkagg lacp agg size` command, which is described in “[Creating and Deleting a Dynamic Aggregate Group](#)” on page 10-9.

2 Configure the Same Administrative Key on the Ports You Want to Join the Dynamic Aggregate Group. To configure ports with the same administrative key (which allows them to be aggregated), use the `linkagg lacp agg actor admin-key` command, which is described in “[Configuring Ports to Join and Removing Ports in a Dynamic Aggregate Group](#)” on page 10-10.

Note. Depending on the needs of your network you need to configure additional parameters. Commands to configure optional dynamic link aggregate parameters are described in “[Modifying Dynamic Link Aggregate Group Parameters](#)” on page 10-12. These commands must be executed after you create a dynamic aggregate group.

Creating and Deleting a Dynamic Aggregate Group

The following subsections describe how to create and delete dynamic aggregate groups with the `linkagg lacp agg size` command.

Creating a Dynamic Aggregate Group

To configure a dynamic aggregate group, enter `linkagg lacp agg` followed by the user-configured dynamic aggregate number, **size**, and the maximum number of links that belong to this dynamic aggregate group. For example, to configure the dynamic aggregate group 2 consisting of eight links enter:

```
-> linkagg lacp agg 2 size 8
```

You can create up to 32 link aggregation (both static and dynamic) groups for a standalone switch and up to 128 groups for a chassis-based switch. In addition, you can also specify optional parameters shown in the table below. These parameters must be entered after **size** and the user-specified number of links.

linkagg lacp agg size keywords

name	admin state enable	partner admin-key
actor system-priority	admin state disable	actor admin-key
partner system-priority	actor system-id	partner system-id

For example, Alcatel-Lucent recommends assigning the actor admin key when you create the dynamic aggregate group to help ensure that ports are assigned to the correct group. To create a dynamic aggregate group with aggregate number 3 consisting of two ports with an admin actor key of 10, for example, enter:

```
-> linkagg lacp agg 3 size 2 actor admin-key 10
```

Note. The optional keywords for this command can be entered in any order as long as they are entered after **size** and the user-specified number of links.

Deleting a Dynamic Aggregate Group

To remove a dynamic aggregation group configuration from a switch use the **no** form of the **linkagg lacp agg size** command by entering **no linkagg lacp agg** followed by its dynamic aggregate group number.

For example, to delete dynamic aggregate group 2 from the switch configuration, enter:

```
-> no linkagg lacp agg 2
```

Note. You cannot delete a dynamic aggregate group if it has any attached ports. To remove attached ports you must disable the dynamic aggregate group with the **linkagg lacp agg admin-state** command, which is described in [“Disabling a Dynamic Aggregate Group” on page 10-13](#).

Configuring Ports to Join and Removing Ports in a Dynamic Aggregate Group

The following subsections describe how to configure ports with the same administrative key (which allows them to be aggregated) or to remove them from a dynamic aggregate group with the **linkagg lacp agg actor admin-key** command.

Configuring Ports To Join a Dynamic Aggregate Group

To configure ports with the same administrative key (which allows them to be aggregated) enter **lacp port**, the port number, **actor admin-key**, and the user-specified actor administrative key. Ports must be of the same speed.

For example, to configure ports 1, 2, and 3 in chassis 4 with an administrative key of 10, enter:

```
-> linkagg lacp port 4/1/1-3 actor admin-key 10
```

Note. A port can belong to only one aggregate group.

You must execute the **linkagg lacp port actor admin-key** command on all ports in a dynamic aggregate group. If not, the ports are unable to join the group.

In addition, you can also specify optional parameters shown in the table below. These keywords must be entered after the actor admin-key and the user-specified actor administrative key value.

lacp agg actor admin-key keywords

actor admin-state	partner admin-state	actor system-id
actor system-priority	partner admin system-id	partner admin-key
partner admin-system-priority	actor port-priority	partner admin-port
partner admin port-priority		

Note. The **actor admin-state** and **partner admin-state** keywords have additional parameters, which are described in [“Modifying the Actor Port System Administrative State” on page 10-17](#) and [“Modifying the Partner Port System Administrative State” on page 10-21](#), respectively.

All of the optional keywords listed above for this command can be entered in any order as long as they appear after the **actor admin-key** keywords and their user-specified value.

For example, to configure actor administrative key of 10, a local system ID (MAC address) of 00:20:da:06:ba:d3, and a local priority of 65535 to port 4/1/1, enter:

```
-> linkagg lacp port 4/1/1 actor admin-key 10 actor system-id 00:20:da:06:ba:d3
actor system-priority 65535
```

For example, to configure an actor administrative key of 10 to port 1/4/1, enter:

```
-> linkagg lacp port 4/1/1 actor admin-key 10
```

Removing Ports from a Dynamic Aggregate Group

To remove a port from a dynamic aggregate group, use the **no** form of the **linkagg lacp agg actor admin-key** command by entering **linkagg lacp port** and the port number.

For example, to remove port 4 from any dynamic aggregate group, enter:

```
-> no linkagg lacp port 4/1/4
```

Ports must be deleted in the reverse order in which they were configured. For example, if port 4/1/4 through 4/1/6 were configured to join dynamic aggregate group 2 you must first delete port 4/1/6, then port 4/1/5, and so forth. The following is an example of how to delete ports in the proper sequence from the console:

```
-> no linkagg lacp port 4/1/6
-> no linkagg lacp port 4/1/5
-> no linkagg lacp port 4/1/4
```

Modifying Dynamic Link Aggregate Group Parameters

The table on [page 10-3](#) lists default group and port settings for Alcatel-Lucent Dynamic Link Aggregation software. These parameters ensure compliance with the IEEE 802.3ad specification. For most networks, these default values need not be modified or can be modified automatically by the switch software. However, if you need to modify any of these default settings, see the following sections to modify the parameters for:

- Dynamic aggregate groups on [page 10-12](#)
- Dynamic aggregate actor ports on [page 10-17](#)
- Dynamic aggregate partner ports on [page 10-21](#)

Note. You must create a dynamic aggregate group before you can modify group or port parameters. See [“Configuring Dynamic Link Aggregate Groups” on page 10-8](#) for more information.

Modifying Dynamic Aggregate Group Parameters

This section describes how to modify the following dynamic aggregate group parameters:

- Group name (see [“Modifying the Dynamic Aggregate Group Name” on page 10-13](#))
- Group administrative state (see [“Modifying the Dynamic Aggregate Group Administrative State” on page 10-13](#))
- Group local (actor) switch actor administrative key (see [“Configuring and Deleting the Dynamic Aggregate Group Actor Administrative Key” on page 10-14](#))
- Group local (actor) switch system priority (see [“Modifying the Dynamic Aggregate Group Actor System Priority” on page 10-14](#))
- Group local (actor) switch system ID (see [“Modifying the Dynamic Aggregate Group Actor System ID” on page 10-15](#))
- Group remote (partner) administrative key (see [“Modifying the Dynamic Aggregate Group Partner Administrative Key” on page 10-15](#))
- Group remote (partner) system priority (see [“Modifying the Dynamic Aggregate Group Partner System Priority” on page 10-16](#))
- Group remote (partner) switch system ID (see [“Modifying the Dynamic Aggregate Group Partner System ID” on page 10-16](#))

Modifying the Dynamic Aggregate Group Name

The following subsections describe how to configure and remove a dynamic aggregate group name with the **linkagg lacp agg name** command.

Configuring a Dynamic Aggregate Group name

To configure a dynamic aggregate group name, enter **linkagg lacp agg** followed by the dynamic aggregate group number, **name**, and the user-specified name.

For example, to name dynamic aggregate group 4 “Engineering”, enter:

```
-> linkagg lacp agg 4 name Engineering
```

Note. If you want to specify spaces within a name, the name must be enclosed in quotes. For example:

```
-> linkagg lacp agg 4 name "Engineering Lab"
```

Deleting a Dynamic Aggregate Group Name

To remove a dynamic aggregate group name from the configuration of a switch, use the **no** form of the **linkagg lacp agg name** command by entering **linkagg lacp agg** followed by the dynamic aggregate group number and **no name**.

For example, to remove any user-configured name from dynamic aggregate group 4, enter:

```
-> no linkagg lacp agg 4 name
```

Modifying the Dynamic Aggregate Group Administrative State

By default, the dynamic aggregate group administrative state is enabled. The following subsections describe how to enable and disable the administrative state of a dynamic aggregate group with the **linkagg lacp agg admin-state** command.

Enabling a Dynamic Aggregate Group

To enable the dynamic aggregate group administrative state, enter **linkagg lacp agg** followed by the dynamic aggregate group number and **admin-state enable**. For example, to enable dynamic aggregate group 4, enter:

```
-> linkagg lacp agg 4 admin-state enable
```

Disabling a Dynamic Aggregate Group

To disable the administrative state of a dynamic aggregate group, use the **linkagg lacp agg admin-state** command by entering **linkagg lacp agg** followed by the dynamic aggregate group number and **admin-state disable**.

For example, to disable dynamic aggregate group 4, enter:

```
-> linkagg lacp agg 4 admin-state disable
```

Configuring and Deleting the Dynamic Aggregate Group Actor Administrative Key

The following subsections describe how to configure and delete a dynamic aggregate group actor administrative key with the **linkagg lacp agg actor admin-key** command.

Configuring a Dynamic Aggregate Actor Administrative Key

To configure the dynamic aggregate group actor switch administrative key, enter **linkagg lacp agg** followed by the dynamic aggregate group number, **actor admin-key**, and the value for the administrative key.

For example, to configure dynamic aggregate group 4 with an administrative key of 10, enter:

```
-> linkagg lacp agg 4 actor admin-key 10
```

Deleting a Dynamic Aggregate Actor Administrative Key

To remove an actor switch administrative key from the configuration of a dynamic aggregate group, use the **no** form of the **linkagg lacp agg actor admin-key** command by entering **linkagg lacp agg** followed by the dynamic aggregate group number and the **actor admin-key** parameter.

For example, to remove an administrative key from dynamic aggregate group 4, enter:

```
-> no linkagg lacp agg 4 actor admin-key
```

Modifying the Dynamic Aggregate Group Actor System Priority

By default, the dynamic aggregate group actor system priority is 0. The following subsections describe how to configure a user-specified value and how to restore the value to its default value with the **linkagg lacp agg actor system-priority** command.

Configuring a Dynamic Aggregate Group Actor System Priority

You can configure a user-specified dynamic aggregate group actor system priority value by entering **linkagg lacp agg** followed by the dynamic aggregate group number, **actor system-priority**, and the new priority value.

For example, to change the actor system priority of dynamic aggregate group 4 to 2000, enter:

```
-> linkagg lacp agg 4 actor system-priority 2000
```

Restoring the Dynamic Aggregate Group Actor System Priority

To restore the dynamic aggregate group actor system priority to its default (0) value use the **no** form of the **linkagg lacp agg actor system-priority** command by entering **no linkagg lacp agg** followed by the dynamic aggregate group number and **no actor system priority**.

For example, to restore the actor system priority to its default value on dynamic aggregate group 4, enter:

```
-> no linkagg lacp agg 4 actor system-priority
```

Modifying the Dynamic Aggregate Group Actor System ID

By default, the dynamic aggregate group actor system ID (MAC address) is 00:00:00:00:00:00. The following subsections describe how to configure a user-specified value and how to restore the value to its default value with the [linkagg lacp agg actor system-id](#) command.

Configuring a Dynamic Aggregate Group Actor System ID

You can configure a user-specified dynamic aggregate group actor system ID by entering **linkagg lacp agg** followed by the dynamic aggregate group number, **actor system-id**, and the user-specified MAC address (in the hexadecimal format of *xx:xx:xx:xx:xx:xx*), which is used as the system ID.

For example, to configure the system ID on dynamic aggregate group 4 as 00:20:da:81:d5:b0, enter:

```
-> linkagg lacp agg 4 actor system-id 00:20:da:81:d5:b0
```

Restoring the Dynamic Aggregate Group Actor System ID

To remove the user-configured actor switch system ID from the configuration of a dynamic aggregate group, use the **no** form of the [linkagg lacp agg actor system-id](#) command by entering **linkagg lacp agg** followed by the dynamic aggregate group number and **actor system-id**.

For example, to remove the user-configured system ID from dynamic aggregate group 4, enter:

```
-> no linkagg lacp agg 4 actor system-id
```

Modifying the Dynamic Aggregate Group Partner Administrative Key

By default, the dynamic aggregate group partner administrative key (the administrative key of the partner switch) is 0. The following subsections describe how to configure a user-specified value and how to restore the value to its default value with the [linkagg lacp agg partner admin-key](#) command.

Configuring a Dynamic Aggregate Group Partner Administrative Key

You can modify the dynamic aggregate group partner administrative key to a value ranging from 0 to 65535 by entering **linkagg lacp agg** followed by the dynamic aggregate group number, **partner admin-key** parameter, and the value for the administrative key.

For example, to set the partner administrative key to 4 on dynamic aggregate group 4, enter:

```
-> linkagg lacp agg 4 partner admin-key 10
```

Restoring the Dynamic Aggregate Group Partner Administrative Key

To remove a partner administrative key from the configuration of a dynamic aggregate group, use the **no** form of the [linkagg lacp agg partner admin-key](#) command by entering **no linkagg lacp agg** followed by the dynamic aggregate group number and the **partner admin-key** parameter.

For example, to remove the user-configured partner administrative key from dynamic aggregate group 4, enter:

```
-> no linkagg lacp agg 4 partner admin-key
```

Modifying the Dynamic Aggregate Group Partner System Priority

By default, the dynamic aggregate group partner system priority is 0. The following subsections describe how to configure a user-specified value and how to restore the value to its default value with the **linkagg lacp agg partner system-priority** command.

Configuring a Dynamic Aggregate Group Partner System Priority

You can modify the dynamic aggregate group partner system priority to a value by entering **linkagg lacp agg** followed by the dynamic aggregate group number, **partner system-priority**, and the new priority value.

For example, to set the partner system priority on dynamic aggregate group 4 to 2000, enter:

```
-> linkagg lacp agg 4 partner system-priority 2000
```

Restoring the Dynamic Aggregate Group Partner System Priority

To restore the dynamic aggregate group partner system priority to its default (0) value use the **no** form of the **linkagg lacp agg partner system-priority** command by entering **no linkagg lacp agg** followed by the dynamic aggregate group number and **partner system-priority**.

For example, to reset the partner system priority of dynamic aggregate group 4 to its default value, enter:

```
-> no linkagg lacp agg 4 partner system-priority
```

Modifying the Dynamic Aggregate Group Partner System ID

By default, the dynamic aggregate group partner system ID is 00:00:00:00:00:00. The following subsections describe how to configure a user-specified value and how to restore it to its default value with the **linkagg lacp agg partner system-id** command.

Configuring a Dynamic Aggregate Group Partner System ID

You can configure the dynamic aggregate group partner system ID by entering **linkagg lacp agg** followed by the dynamic aggregate group number, **partner system-id**, and the user-specified MAC address (in the hexadecimal format of *xx:xx:xx:xx:xx:xx*), which is used as the system ID.

For example, to configure the partner system ID as 00:20:da:81:d5:b0 on dynamic aggregate group 4, enter:

```
-> linkagg lacp agg 4 partner system-id 00:20:da:81:d5:b0
```

Restoring the Dynamic Aggregate Group Partner System ID

To remove the user-configured partner switch system ID from the configuration of a dynamic aggregate group, use the **no** form of the **linkagg lacp agg partner system-id** command by entering **no linkagg lacp agg** followed by the dynamic aggregate group number and the **partner system-id** parameter.

For example, to remove the user-configured partner system ID from dynamic aggregate group 4, enter:

```
-> no linkagg lacp agg 4 partner system-id
```

Modifying Dynamic Link Aggregate Actor Port Parameters

This section describes how to modify the following dynamic aggregate actor port parameters:

- Actor port administrative state (see “[Modifying the Actor Port System Administrative State](#)” on page 10-17)
- Actor port system ID (see “[Modifying the Actor Port System ID](#)” on page 10-19)
- Actor port system priority (see “[Modifying the Actor Port System Priority](#)” on page 10-19)
- Actor port priority (see “[Modifying the Actor Port Priority](#)” on page 10-20)

Note. See “[Configuring Ports to Join and Removing Ports in a Dynamic Aggregate Group](#)” on page 10-10 for information on modifying a dynamic aggregate group administrative key. A port can belong to only one aggregate group.

Note. A port can belong to only one aggregate group.

Modifying the Actor Port System Administrative State

The system administrative state of a dynamic aggregate group actor port is indicated by bit settings in Link Aggregation Control Protocol Data Unit (LACPDU) frames sent by the port. By default, bits 0 (indicate that the port is active), 1 (indicate that short timeouts are used for LACPDU frames), and 2 (indicate that this port is available for aggregation) are set in LACPDU frames.

The following subsections describe how to configure user-specified values and how to restore them to their default values with the `linkagg lacp agg admin-state` command.

Configuring Actor Port Administrative State Values

To configure the system administrative state values of the LACP actor port, enter `linkagg lacp port`, the port number, `actor admin-state`, and one or more of the keywords shown in the table below *or* use the `none` keyword:

<code>linkagg lacp agg actor admin-state</code> Keyword	Definition
<code>active</code>	Specifies that bit 0 in LACPDU frames is set, which indicates that the link is able to exchange LACPDU frames. By default, this bit is set.
<code>timeout</code>	Specifies that bit 1 in LACPDU frames is set, which indicates that a short time-out is used for LACPDU frames. When this bit is disabled, a long time-out is used for LACPDU frames. By default, this bit is set.
<code>aggregate</code>	Specifies that bit 2 in LACPDU frames is set, which indicates that the system considers this link to be a potential candidate for aggregation. If this bit is not set, the system considers the link to be individual (it can only operate as a single link). By default, this bit is set.

linkagg lacp agg actor admin-state Keyword	Definition
synchronize	Specifying this keyword has no effect because the system always determines its value. When this bit (bit 3) is set by the system, the port is allocated to the correct dynamic aggregation group. If this bit is not set by the system, the port is not allocated to the correct dynamic aggregation group.
collect	Specifying this keyword has no effect because the system always determines its value. When this bit (bit 4) is set by the system, incoming LACPDU frames are collected from the individual ports that make up the dynamic aggregate group.
distribute	Specifying this keyword has no effect because the system always determines its value. When this bit (bit 5) is set by the system, distributing outgoing frames on the port is disabled.
default	Specifying this keyword has no effect because the system always determines its value. When this bit (bit 6) is set by the system, it indicates that the actor is using defaulted partner information administratively configured for the partner.
expire	Specifying this keyword has no effect because the system always determines its value. When this bit (bit 7) is set by the system, the actor cannot receive LACPDU frames.

Note. Specifying **none** removes all administrative states from the LACPDU configuration. For example:

```
-> linkagg lacp port 5/1/49 actor admin-state none
```

For example, to set bits 0 (**active**) and 2 (**aggregate**) on dynamic aggregate actor port 5/1/49 you would enter:

```
-> linkagg lacp port 5/1/49 actor admin-state active aggregate
```

For example, to set bits 0 (**active**) and 2 (**aggregate**) on dynamic aggregate actor port 5/1/49, enter:

```
-> linkagg lacp port 5/1/49 actor admin-state active aggregate
```

Restoring Actor Port Administrative State Values

To restore LACPDU bit settings to their default values, use the **no** form of the **linkagg lacp port actor admin-state** command by entering the **active**, **timeout**, and **aggregate** keywords.

For example, to restore bits 0 (**active**) and 2 (**aggregate**) to their default settings on dynamic aggregate actor port 5/1/2, enter:

```
-> no linkagg lacp port 5/1/2 actor admin-state active aggregate
```

Note. Since individual bits with the LACPDU frame are set with the **linkagg lacp agg actor admin-state** command you can set some bits on and restore other bits within the same command. For example, if you wanted to restore bit 2 (**aggregate**) to its default settings and set bit 0 (**active**) on dynamic aggregate actor port 5/1/49 you would enter:

```
-> no linkagg lacp agg 5/1/49 actor admin-state active aggregate
```

Modifying the Actor Port System ID

By default, the actor port system ID (the MAC address used as the system ID on dynamic aggregate actor ports) is 00:00:00:00:00:00. The following subsections describe how to configure a user-specified value and how to restore the value to its default value with the **linkagg lacp port actor system-id** command.

Configuring an Actor Port System ID

You can configure the actor port system ID by entering **linkagg lacp port**, the port number, **actor system-id**, and the user specified actor port system ID (MAC address) in the hexadecimal format of xx:xx:xx:xx:xx:xx.

For example, to modify the system ID of the dynamic aggregate actor port 7/1/3 to **00:20:da:06:ba:d3**, enter:

```
-> linkagg lacp port 7/1/3 actor system-id 00:20:da:06:ba:d3
```

For example, to modify the system ID of the dynamic aggregate actor port 7/1//3 to **00:20:da:06:ba:d3** and document that the port is 10 Mbps Ethernet you would enter:

```
-> linkagg lacp port 7/1/3 actor system-id 00:20:da:06:ba:d3
```

Restoring the Actor Port System ID

To remove a user-configured system ID from a dynamic aggregate group actor port configuration, use the **no** form of the **linkagg lacp port actor system-id** command by entering **no linkagg lacp agg**, the port number, and **actor system-id** keyword.

For example, to remove a user-configured system ID from dynamic aggregate actor port 7/1/3, enter:

```
-> linkagg lacp port 7/1/3 actor system-id
```

Modifying the Actor Port System Priority

By default, the actor system priority is 0. The following subsections describe how to configure a user-specified value and how to restore the value to its default value with the **linkagg lacp port actor system-priority** command.

Configuring an Actor Port System Priority

You can configure the actor system priority to a value by entering **lacp agg**, the port number, **actor system priority**, and the user-specified actor port system priority.

For example, to modify the system priority of dynamic aggregate actor port 2/1/5 to 200 you would enter:

```
-> linkagg lacp port 2/1/5 actor system-priority 200
```

For example, to modify the system priority of dynamic aggregate actor port 2/1/5 to 200, enter:

```
-> linkagg lacp port 2/1/5 actor system-priority 200
```

Restoring the Actor Port System Priority

To remove a user-configured actor port system priority from a dynamic aggregate group actor port configuration use the **no** form of the **linkagg lacp port actor system-priority** command by entering **no linkagg lacp agg**, the port number, and **actor system priority**.

For example, to remove a user-configured system priority from dynamic aggregate actor port 2/1/5 you would enter:

```
-> no linkagg lacp port 2/1/5 actor system-priority
```

Modifying the Actor Port Priority

By default, the actor port priority (used to converge dynamic key changes) is 0. The following subsections describe how to configure a user-specified value and how to restore the value to its default value with the **linkagg lacp port actor port priority** command.

Configuring the Actor Port Priority

You can configure the actor port priority to a value by entering **linkagg lacp agg**, the port number, **actor port-priority**, and the user-specified actor port priority.

For example, to modify the actor port priority of dynamic aggregate actor port 2/1/1 to 100 you would enter:

```
-> linkagg lacp port 2/1/1 actor port-priority 100
```

For example, to modify the actor port priority of dynamic aggregate actor port 2/1/1 to 100, enter:

```
-> linkagg lacp port 2/1/1 actor port-priority 100
```

Restoring the Actor Port Priority

To remove a user configured actor port priority from a dynamic aggregate group actor port configuration use the **no** form of the **linkagg lacp port actor port priority** command by entering **no linkagg lacp agg**, the port number, and **no actor port priority**.

For example, to remove a user-configured actor priority from dynamic aggregate actor port 2/1/1 you would enter:

```
-> no linkagg lacp port 2/1/1 actor port-priority
```

Modifying Dynamic Aggregate Partner Port Parameters

This section describes how to modify the following dynamic aggregate partner port parameters:

- Partner port system administrative state (see “[Modifying the Partner Port System Administrative State](#)” on page 10-21)
- Partner port administrative key (see “[Modifying the Partner Port Administrative Key](#)” on page 10-23)
- Partner port system ID (see “[Modifying the Partner Port System ID](#)” on page 10-23)
- Partner port system priority (see “[Modifying the Partner Port System Priority](#)” on page 10-24)
- Partner port administrative state (see “[Modifying the Partner Port Administrative Status](#)” on page 10-24)
- Partner port priority (see “[Modifying the Partner Port Priority](#)” on page 10-25)

See [Chapter 1, “Configuring Ethernet Ports,”](#) for information on configuring Ethernet ports.

Note. A port can belong to only one aggregate group.

Modifying the Partner Port System Administrative State

The system administrative state of a dynamic aggregate group partner (remote switch) port is indicated by bit settings in Link Aggregation Control Protocol Data Unit (LACPDU) frames sent by this port. By default, bits 0 (indicating that the port is active), 1 (indicating that short timeouts are used for LACPDU frames), and 2 (indicating that this port is available for aggregation) are set in LACPDU frames.

The following subsections describe how to configure user-specified values and how to restore them to their default values with the `linkagg lacp agg partner admin-state` command.

Configuring Partner Port System Administrative State Values

To configure the system administrative state values for the port on the dynamic aggregate partner, enter `linkagg lacp port`, the port number, `partner admin-state`, and one or more of the keywords shown in the table below *or none*:

Keyword	Definition
active	Specifies that bit 0 in LACPDU frames is set, which indicates that the link is able to exchange LACPDU frames. By default, this bit is set.
timeout	Specifies that bit 1 in LACPDU frames is set, which indicates that a short time-out is used for LACPDU frames. When this bit is disabled, a long time-out is used for LACPDU frames. By default, this bit is set.
aggregate	Specifies that bit 2 in LACPDU frames is set, which indicates that the system considers this link to be a potential candidate for aggregation. If this bit is not set, the system considers the link to be individual (it can only operate as a single link). By default, this bit is set.
synchronize	Specifies that bit 3 in the partner state octet is enabled. When this bit is set, the port is allocated to the correct dynamic aggregation group. If this bit is not enabled, the port is not allocated to the correct aggregation group. By default, this value is disabled.

Keyword	Definition
collect	Specifying this keyword has no effect because the system always determines its value. When this bit (bit 4) is set by the system, incoming LACPDU frames are collected from the individual ports that make up the dynamic aggregate group.
distribute	Specifying this keyword has no effect because the system always determines its value. When this bit (bit 5) is set by the system, distributing outgoing frames on the port is disabled.
default	Specifying this keyword has no effect because the system always determines its value. When this bit (bit 6) is set by the system, it indicates that the partner is using defaulted actor information administratively configured for the partner.
expire	Specifying this keyword has no effect because the system always determines its value. When this bit (bit 7) is set by the system, the actor cannot receive LACPDU frames.

Note. Specifying **none** removes all administrative states from the LACPDU configuration. For example:

```
-> linkagg lacp port 7/1/49 partner admin-state none
```

For example, to set bits 0 (**active**) and 2 (**aggregate**) on dynamic aggregate partner port 7/1/49, enter:

```
-> linkagg lacp port 7/1/49 partner admin-state active aggregate
```

For example, to set bits 0 (**active**) and 2 (**aggregate**) on dynamic aggregate partner port 7/1/49 and document that the port is a Gigabit Ethernet port, enter:

```
-> linkagg lacp port 7/1/49 partner admin-state active aggregate
```

Restoring Partner Port System Administrative State Values

To restore LACPDU bit settings to their default values use the **no** form of the **linkagg lacp agg partner admin-state** command and enter the **active**, **timeout**, **aggregate**, or **synchronize** keywords.

For example, to restore bits 0 (**active**) and 2 (**aggregate**) to their default settings on dynamic aggregate partner port 7/1/1, enter:

```
-> no linkagg lacp port 7/1/1 partner admin-state active aggregate
```

Note. Since individual bits with the LACPDU frame are set with the **linkagg lacp port partner admin state** command you can set some bits on and restore other bits to default values within the same command. For example, if you wanted to restore bit 2 (**aggregate**) to its default settings and set bit 0 (**active**) on dynamic aggregate partner port 7/1/1, enter:

```
-> no linkagg lacp port 7/1/1 partner admin-state active aggregate
```

Modifying the Partner Port Administrative Key

By default, the “administrative key” of the dynamic aggregate partner port is 0. The following subsections describe how to configure a user-specified value and how to restore the value to its default value with the **linkagg lacp agg partner admin-key** command.

Configuring the Partner Port Administrative Key

You can configure the administrative key for the dynamic aggregate partner port to a value ranging from 0 to 65535 enter **linkagg lacp port**, the port number, **partner admin-key**, and the user-specified partner port administrative key.

For example, to modify the administrative key of a dynamic aggregate group partner port 6/1/1 to 1000 enter:

```
-> linkagg lacp port 6/1/1 partner admin-key 1000
```

For example, to modify the administrative key of a dynamic aggregate group partner port 6/1/1, enter:

```
-> linkagg lacp port 6/1/1 partner admin-key 1000
```

Restoring the Partner Port Administrative Key

To remove a user-configured administrative key from the configuration set on a dynamic aggregate group partner port, use the **no** form of the **linkagg lacp agg partner admin-key** command by entering **no linkagg lacp agg**, the port number, and **partner admin-key** keyword.

For example, to remove the user-configured administrative key from dynamic aggregate partner port 6/1/1, enter:

```
-> no linkagg lacp port 6/1/1 partner admin-key
```

Modifying the Partner Port System ID

By default, the partner port system ID (the MAC address used as the system ID on dynamic aggregate partner ports) is 00:00:00:00:00:00. The following subsections describe how to configure a user-specified value and how to restore the value to its default value with the **linkagg lacp port partner admin system-id** command.

Configuring the Partner Port System ID

You can configure the partner port system ID by entering **linkagg lacp port**, the port number, **partner admin system-id**, and the user-specified partner administrative system ID (the MAC address in hexadecimal format).

For example, to modify the system ID of dynamic aggregate partner port 6/1/49 to **00:20:da:06:ba:d3**, enter:

```
-> linkagg lacp port 6/1/49 partner admin system-id 00:20:da:06:ba:d3
```

For example, to modify the system ID of dynamic aggregate partner port 6/1/49 to **00:20:da:06:ba:d3**, enter:

```
-> linkagg lacp port 6/1/49 partner admin system-id 00:20:da:06:ba:d3
```

Restoring the Partner Port System ID

To remove a user-configured system ID from a dynamic aggregate group partner port configuration use the **no** form of the **linkagg lacp port partner admin system-id** command by entering **linkagg lacp agg**, the port number, and the **partner admin system-id** parameters.

For example, to remove a user-configured system ID from dynamic aggregate partner port 6/1/2, enter:

```
-> no linkagg lacp port 6/1/2 partner admin system-id
```

Modifying the Partner Port System Priority

By default, the administrative priority of a dynamic aggregate group partner port is 0. The following subsections describe how to configure a user-specified value and how to restore the value to its default value with the **linkagg lacp agg partner system-priority** command.

Configuring the Partner Port System Priority

You can configure the administrative priority of a dynamic aggregate group partner port to a value ranging from 0 to 255 by entering **linkagg lacp port**, the port number, **partner admin-system-priority**, and the user-specified administrative system priority.

For example, to modify the administrative priority of a dynamic aggregate partner port 4/1/49 to 100, enter:

```
-> linkagg lacp port 4/1/49 partner admin-system-priority 100
```

For example, to modify the administrative priority of dynamic aggregate partner port 4/1/49 to 100 and specify that the port is a Gigabit Ethernet port , enter:

```
-> linkagg lacp port 4/1/49 partner admin-system-priority 100
```

Restoring the Partner Port System Priority

To remove a user-configured system priority from a dynamic aggregate group partner port configuration use the **no** form of the **linkagg lacp agg partner system-priority** command by entering **lacp port**, the port number, and **partner admin-system-priority**.

For example, to remove a user-configured system ID from dynamic aggregate partner port 4/1/3, enter:

```
-> no linkagg lacp port 4/1/3 partner admin-system-priority
```

Modifying the Partner Port Administrative Status

By default, the administrative status of a dynamic aggregate group partner port is 0. The following subsections describe how to configure a user-specified value and how to restore the value to its default value with the **linkagg lacp port partner admin-port** command.

Configuring the Partner Port Administrative Status

You can configure the administrative status of a dynamic aggregate group partner port by entering **linkagg lacp port**, the port number, **partner admin-port**, and the user-specified partner port administrative status.

For example, to modify the administrative status of dynamic aggregate partner port 7/1/1 to 200 you would enter:

```
-> linkagg lacp port 7/1/1 partner admin-port 200
```

For example, to modify the administrative status of dynamic aggregate partner port 7/1/1 to 200, enter:

```
-> linkagg lacp port 7/1/1 partner admin-port 200
```

Restoring the Partner Port Administrative Status

To remove a user-configured administrative status from a dynamic aggregate group partner port configuration use the **no** form of the **linkagg lacp port partner admin-port** command by entering **no linkagg lacp agg**, the port number, and **partner admin-port**.

For example, to remove a user-configured administrative status from dynamic aggregate partner port 7/1/1 you would enter:

```
-> no linkagg lacp port 7/1/1 partner admin-port
```

Modifying the Partner Port Priority

The default partner port priority is 0. The following subsections describe how to configure a user-specified value and how to restore the value to its default value with the **linkagg lacp port partner admin port-priority** command.

Configuring the Partner Port Priority

To configure the partner port priority, enter **lacp agg**, the port number, **partner admin-port priority**, and the user-specified partner port priority.

For example, to modify the port priority of dynamic aggregate partner port 4/1/3 to 100 you would enter:

```
-> linkagg lacp port 4/1/3 partner admin-port priority 100
```

For example, to modify the port priority of dynamic aggregate partner port 4/1/3 to 100, enter:

```
-> linkagg lacp port 4/1/3 partner admin-port priority 100
```

Restoring the Partner Port Priority

To remove a user-configured partner port priority from a dynamic aggregate group partner port configuration use the **no** form of the **linkagg lacp port partner admin port-priority** command by entering **no linkagg lacp port**, the port number, **partner admin-port priority**.

For example, to remove a user-configured partner port priority from dynamic aggregate partner port 4/1/3 you would enter:

```
-> no linkagg lacp port 4/1/3 partner admin-port priority
```

Application Examples

Dynamic link aggregation groups are treated by the software on the switch as similar to individual physical ports. This section demonstrates the dynamic link aggregation feature by providing sample network configurations that use dynamic aggregation along with other software features. In addition, tutorials are provided that show how to configure these sample networks by using Command Line Interface (CLI) commands.

Sample Network Overview

The figure below shows two VLANs on Switch A that use two different link aggregation groups. VLAN 10 has been configured on dynamic aggregate group 5 with Spanning Tree Protocol (STP) with the highest priority (15) possible. And VLAN 12 has been configured on dynamic aggregate group 7 with 802.1Q tagging and 802.1p priority bit settings.

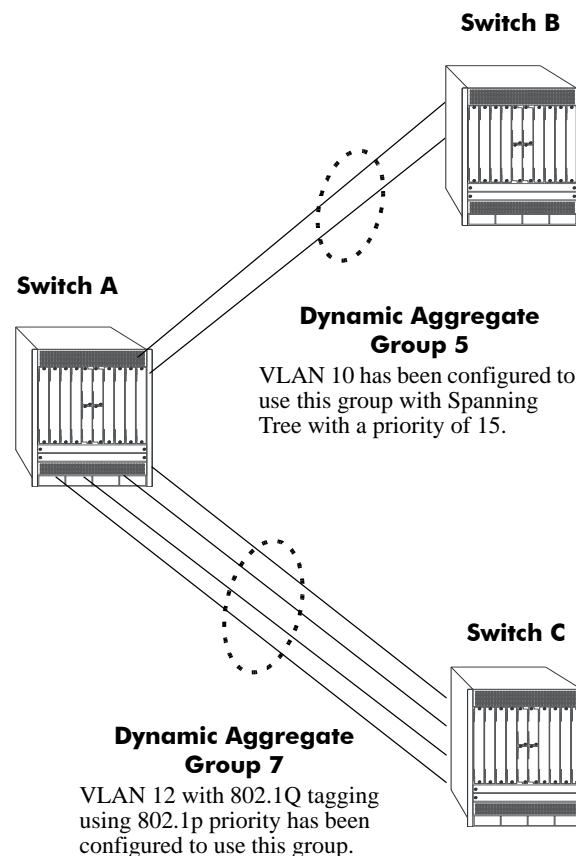

Sample Network Using Dynamic Link Aggregation

The steps to configure VLAN 10 (Spanning Tree example) are described in [“Link Aggregation and Spanning Tree Example”](#) on page 10-27. The steps to configure VLAN 12 (802.1Q and 802.1p example) are described in [“Link Aggregation and QoS Example”](#) on page 10-28.

Note. Although you need to configure both the local (Switch A) and remote (Switches B and C) switches, only the steps to configure the local switch are provided since the steps to configure the remote switches are similar.

Link Aggregation and Spanning Tree Example

As shown in the figure on [page 10-26](#), VLAN 10, which uses the Spanning Tree Protocol (STP) with a priority of 15, has been configured to use dynamic aggregate group 7. Follow the steps below to configure this network:

Note. Only the steps to configure the local (Switch A) are provided here since the steps to configure the remote (Switch B) are similar.

- 1** Configure dynamic aggregate group 5 by entering:

```
-> linkagg lacp agg 5 size 2
```

- 2** Configure ports 5/1/5 and 5/1/6 with the same actor administrative key (5) by entering:

```
-> linkagg lacp port 5/1/5-6 actor admin-key 5
```

- 3** Create VLAN 10 by entering:

```
-> vlan 10
```

- 4** If the Spanning Tree Protocol (STP) has been disabled on this VLAN (STP is enabled by default), enable it on VLAN 10 by entering:

- 5** Configure VLAN 10 (which uses dynamic aggregate group 5) to the highest (15) priority possible by entering:

```
-> spantree vlan 10 linkagg 5 priority 15
```

- 6** Repeat steps 1 through 5 on Switch B. Substitute the port numbers of the commands with the appropriate port numbers of Switch B.

Link Aggregation and QoS Example

As shown in the figure on [page 10-26](#), VLAN 12, which uses 802.1Q frame tagging and 802.1p priority, is configured to use dynamic aggregate group 7. Follow the steps below to configure this network:

Note. Only the steps to configure the local (Switch A) switch are provided here since the steps to configure the remote (Switch C) switch would not be significantly different.

- 1 Configure dynamic aggregate group 7 by entering:

```
-> linkagg lacp agg 7 size 4
```

- 2 Configure ports 4/1/1, 4/1/2, 4/1/3, and 4/1/4 the same actor administrative key (7) by entering:

```
-> lacp agg 4/1/1-4 actor admin-key 7
```

- 3 Create VLAN 12 by entering:

```
-> vlan 12
```

- 4 Configure 802.1Q tagging with a tagging ID (VLAN ID) of 12 on dynamic aggregate group 7 by entering:

```
-> vlan 12 members 7 tagged
```

- 5 If the QoS Manager has been disabled (it is enabled by default) enable it by entering:

```
-> qos enable
```

Note. *Optional.* Use the [show qos config](#) command to determine if the QoS Manager is enabled or disabled.

- 6 Configure a policy condition for VLAN 12 called “vlan12_condition” by entering:

```
-> policy condition vlan12_condition destination vlan 12
```

- 7 Configure an 802.1p policy action with the highest priority possible (7) for VLAN 12 called “vlan12_action” by entering:

```
-> policy action vlan12_action 802.1P 7
```

- 8 Configure a QoS rule called “vlan12_rule” by using the policy condition and policy rules you configured in steps 8 and 9 above by entering:

```
-> policy rule vlan12_rule enable condition vlan12_condition action  
vlan12_action
```

- 9 Enable your 802.1p QoS settings by entering **qos apply** as shown below:

```
-> qos apply
```

- 10 Repeat steps 1 through 9 on Switch C. Use the same commands as mentioned in the previous steps. Substitute the port numbers of the commands with the appropriate port numbers of Switch C.

Note. If you do not use the **qos apply** command any QoS policies previously configured, are lost on the next switch reboot.

Displaying Dynamic Link Aggregation Configuration and Statistics

You can use Command Line Interface (CLI) **show** commands to display the current configuration and statistics of link aggregation. These commands include the following:

linkagg range Displays information on link aggregation groups.
show linkagg port Displays information on link aggregation ports.

When you use the **show linkagg** command without specifying the link aggregation group number and when you use the **show linkagg port** command without specifying the port number, these commands provide a “global” view of switch-wide link aggregate group and link aggregate port information, respectively.

For example, to display global statistics on all link aggregate groups (both dynamic and static), enter:

```
-> show linkagg
```

A screen similar to the following would be displayed:

Number	Aggregate	SNMP Id	Size	Admin State	Oper State	Att/Sel	Ports
1	Static	40000001	8	ENABLED	UP	2	2
2	Dynamic	40000002	4	ENABLED	DOWN	0	0
3	Dynamic	40000003	8	ENABLED	DOWN	0	2
4	Static	40000005	2	DISABLED	DOWN	0	0

When you use the **show linkagg** command with the **agg** keyword and the link aggregation group number and when you use the **show linkagg port** command with the port number, these commands provide detailed views of the link aggregate group and port information, respectively. These detailed views provide excellent tools for diagnosing and troubleshooting problems.

For example, to display detailed statistics for port 2/1/1 that is attached to dynamic link aggregate group 1, enter:

```
-> show linkagg port 2/1/1
```

A screen similar to the following would be displayed:

```
Dynamic Aggregable Port
  SNMP Id                : 2001,
  Chas/Slot/Port         : 2/1/1,
  Administrative State   : ENABLED,
  Operational State      : DOWN,
  Port State             : CONFIGURED,
  Link State             : DOWN,
  Selected Agg Number    : NONE,
  Primary port           : UNKNOWN,
LACP
  Actor System Priority   : 10,
  Actor System Id        : [00:d0:95:6a:78:3a],
  Actor Admin Key        : 8,
  Actor Oper Key         : 8,
  Partner Admin System Priority : 20,
  Partner Oper System Priority : 20,
  Partner Admin System Id : [00:00:00:00:00:00],
  Partner Oper System Id  : [00:00:00:00:00:00],
  Partner Admin Key      : 8,
  Partner Oper Key       : 0,
  Attached Agg Id        : 0,
  Actor Port             : 7,
  Actor Port Priority     : 15,
  Partner Admin Port     : 0,
  Partner Oper Port      : 0,
  Partner Admin Port Priority : 0,
  Partner Oper Port Priority : 0,
  Actor Admin State      : act1.tim1.aggl.syn0.col0.dis0.def1.exp0,
  Actor Oper State       : act1.tim1.aggl.syn0.col0.dis0.def1.exp0,
  Partner Admin State    : act0.tim0.aggl.syn1.col1.dis1.def1.exp0,
  Partner Oper State     : act0.tim0.aggl.syn0.col1.dis1.def1.exp0
```

See the “Link Aggregation Commands” chapter in the *OmniSwitch AOS Release 8 CLI Reference Guide* for complete documentation of **show** commands for link aggregation

11 Configuring Dual-Home Links

Dual-Home Link (DHL) is a high availability feature that provides fast failover between core and edge switches without implementing Spanning Tree. The OmniSwitch provides the following method for implementing a DHL solution:

DHL Active-Active—an edge technology that splits a number of VLANs between two active links. The forwarding status of each VLAN is modified by DHL to prevent network loops and maintain connectivity to the core when one of the links fails. This solution does not require link aggregation.

In This Chapter

This chapter describes the basic components of DHL solutions and how to configure them through the Command Line Interface (CLI). CLI commands are used in the configuration examples; for more details about the syntax of commands, see the *OmniSwitch AOS Release 8 CLI Reference Guide*.

Information and procedures described in this chapter include:

- [“Dual-Home Link Specifications” on page 11-2.](#)
- [“Dual-Home Link Active-Active Defaults” on page 11-2](#)
- [“Dual-Home Link Active-Active” on page 11-3.](#)
- [“Configuring DHL Active-Active” on page 11-6.](#)
- [“Dual-Home Link Active-Active Example” on page 11-8.](#)
- [“Displaying the Dual-Home Link Configuration” on page 11-12](#)

Dual-Home Link Specifications

The table below lists specifications for dynamic aggregation groups and ports:

Platforms Supported	OmniSwitch 6860/6860E
DHL session supported	1 per switch

Dual-Home Link Active-Active Defaults

The table below lists default values for dual-home link aggregate groups.

Parameter Description	Command	Default Value/Comments
DHL session ID	dhl name	If a name is not assigned to a DHL session, the session is configured as DHL-1
Admin state of DHL session	dhl num admin-state	disable
Configure a port/link agg as DHL	dhl num linka linkb	NA
Configure a VLAN-MAP	dhl num vlan-map linkb	NA
Pre-emption timer for the DHL session	dhl num pre-emption-time	30 seconds

Dual-Home Link Active-Active

Dual-Home Link (DHL) Active-Active is a high availability feature that provides fast failover between core and edge switches without using Spanning Tree. To provide this functionality, DHL Active-Active splits a number of VLANs between two active links. The forwarding status of each VLAN is modified by DHL to prevent network loops and maintain connectivity to the core when one of the links fails.

The DHL Active-Active feature, however, is configurable on regular switch ports and on logical link aggregate ports (linkagg ID) instead of just LACP aggregated ports. In addition, the two DHL links are both active, as opposed to the active and standby mode used with LACP.

DHL Active-Active Operation

A DHL Active-Active configuration consists of the following components:

- A DHL session. Only one session per switch is allowed.
- Two DHL links associated with the session (link A and link B). A physical switch port or a logical link aggregate (linkagg) ID are configurable as a DHL link.
- A group of VLANs (or pool of common VLANs) in which each VLAN is associated (802.1q tagged) with both link A and link B.
- A VLAN-to-link mapping that specifies which of the common VLANs each DHL link services. This mapping prevents network loops by designating only one active link for each VLAN, even though both links remain active and are associated with each of the common VLANs.

When one of the two active DHL links fails or is brought down, the VLANs mapped to that link are then forwarded on the remaining active link to maintain connectivity to the core. When the failed link comes back up, DHL waits a configurable amount of time before the link resumes forwarding of its assigned VLAN traffic.

The following diagram shows how DHL works when operating in a normal state (both links up) and when operating in a failed state (one link is down):

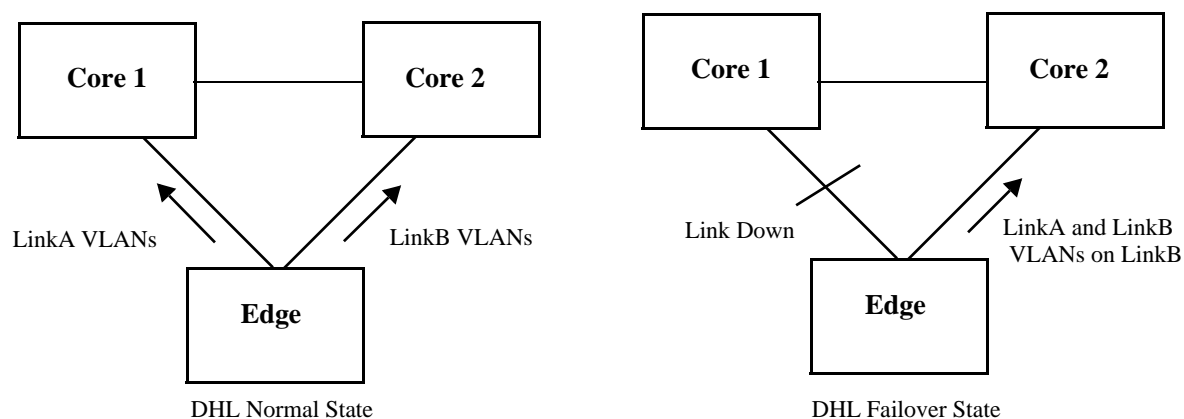

Protected VLANs

A protected VLAN is one that is assigned to both links in a DHL session. This means that if the link to which the VLAN is mapped fails, the VLAN is moved to the other active DHL link to maintain connectivity with the core switches.

Any VLAN that is only assigned to one of the DHL links is considered an unprotected VLAN. This type of VLAN is not eligible for DHL support if the link to which the VLAN is assigned fails.

DHL Port Types

DHL is supported on the following port types:

- Physical switch ports.
- Logical link aggregate ports (linkagg ID).
- LPS ports
- NNI ports
- IPM VLAN ports
- DHCP Snooping ports
- IP Source filtering ports.

DHL is not supported on the following port types:

- Any port that is a member of a link aggregate.
- Mobile ports
- 802.1x ports
- GVRP ports.
- UNI ports
- Ports that are enabled for transparent bridging.

Note. No CLI error message is displayed when DHL is configured using a port type that is not supported.

DHL Pre-Emption Timer

The DHL pre-emption timer specifies the amount of time to wait before a failed link that has recovered can resume servicing VLANs that are mapped to that link. This time value is configured on a per-DHL session basis.

MAC Address Flushing

Spanning Tree flushes the MAC address table when a topology change occurs that also changes the forwarding topology. The MAC addresses are then relearned according to the new forwarding topology. This prevents MAC address entries from becoming stale (entries contain old forwarding information).

When a port is configured as a DHL Active-Active link, Spanning Tree is automatically disabled on the port. Since Spanning Tree is not used, a changeover from one DHL link to the other does not trigger a

topology change event and the MAC address table is not automatically flushed. This can create stale MAC address entries that are looking for end devices over the wrong link.

To avoid stale MAC address entries in the forwarding tables of the core switches, some type of communication needs to occur between the edge uplink switch and the core switches. The DHL Active-Active feature provides two methods for clearing stale MAC address entries: MVRP Enhanced Operation or Raw Flooding. Selecting which one of these methods to use is done on a per-DHL session basis.

MVRP Enhanced Operation

The switch uses an enhanced Multiple VLAN Registration Protocol (MVRP) operation to refresh core MAC address tables as follows:

- For each uplink port, the switch issues joins for each VLAN that is active on that port. This causes the core switch to only register those VLANs that are active on each link based on the DHL configuration.
- When one of the DHL links fails, the other link issues joins to establish connectivity for the VLANs that were serviced by the failed link. These new joins contain the “new” flag set, which are forwarded by the core devices and trigger a flush of the MAC addresses on the core network for the joined VLANs.
- When a failed DHL link recovers, the link issues new joins to re-establish connectivity for the VLANs the link was servicing before the link went down. These new joins also trigger a flush of the MAC addresses on the core network for the joined VLANs.

The switch interacts normally with the core and other devices for MVRP, treating the DHL VLANs on each uplink port as a fixed registration. This approach requires core devices that support MVRP.

Raw Flooding

When a DHL link fails or recovers and Raw Flooding is enabled for the DHL session, the switch performs the following tasks to trigger MAC movement:

- Identify a list of MAC addresses within the effected VLANs that were learned on non-DHL ports (MAC addresses that were reachable through the effected VLANs).
- Create a tagged packet for each of these addresses. The SA for the packet is one of the MAC addresses from the previously-generated list; the VLAN tag is the resident VLAN for the MAC address; the DA is set for broadcast (all Fs); the body is just filler.
- Transmit the generated packet once for each VLAN-MAC address combination. These packets are sent on the link that takes over for the failed link or on a link that has recovered from a failure.

The MAC movement triggered by the Raw Flooding method clears any stale MAC entries. However, flooded packets are often assigned a low priority and the switch may filter such packets in a highly utilized network.

DHL Configuration Guidelines

Review the following guidelines before attempting to configure a DHL setup:

- Make sure that DHL linkA *and* linkB are associated with each VLAN protected by the DHL session. Any VLAN not associated with either link or only associated with one of the links is unprotected.
- DHL linkA *and* linkB must belong to the same default VLAN. In addition, select a default VLAN that is one of the VLANs protected by the DHL session. For example, if the session is going to protect VLANs 10-20, then assign one of those VLANs as the default VLAN for linkA and linkB.
- Only one DHL session per switch is allowed. Each session can have only two links (linkA and linkB). Specify a physical switch port or a link aggregate (linkagg) ID as a DHL link. The same port or link aggregate is not configurable as both linkA or linkB.
- The administrative state of a DHL session is not configurable until a linkA port and a linkB port are associated with the specified DHL session ID number.
- Spanning Tree is automatically disabled on each link when the DHL session is enabled.
- Do not change the link assignments for the DHL session while the session is enabled.
- Configuring a MAC address flush method (MVRP or Raw Flooding) is recommended if the DHL session ports span across switch modules. This configuration improves convergence time.
- Enabling the registrar mode as “forbidden” is recommended before MVRP is enabled on DHL links.

Configuring DHL Active-Active

Configuring a DHL Active-Active setup requires the following tasks.

- 1 Configure a set of VLANs that the two DHL session links service.

```
-> vlan 100-110
```

- 2 Identify two ports or link aggregates that serve as the links for the DHL session then assign both links to the same default VLAN. Make sure the default VLAN is one of the VLANs created in Step 1. For example, the following commands assign VLAN 100 as the default VLAN for port 1/1/10 and linkagg 5:

```
-> vlan 100 members port 1/1/10 untagged
-> vlan 100 members linkagg 5 untagged
```

- 3 Associate (802.1q tag) the ports identified in Step 2 to each one of the VLANs created in Step 1, except for the default VLAN already associated with each port. For example, the following commands associate port 1/1/10 and linkagg 5 with VLANs 101-110:

```
-> vlan 101-110 members port 1/1/10 tagged
-> vlan 101-110 members linkagg 5 tagged
```

In the above command example, port 1/1/10 and linkagg 5 are only tagged with VLANs 101-110 because VLAN 100 is already the default VLAN for both ports.

- 4 Create a DHL session using the **dhl name** command. For example:

```
-> dhl 10
```

- 5 Configure the pre-emption (recovery) timer for the DHL session using the **dhl num pre-emption-time** command. By default, the timer is set to 30 seconds, so it is only necessary to change this parameter if the default value is not sufficient. For example, the following command changes the timer value 500 seconds:

```
-> dhl 10 pre-emption-time 500
```

6 Configure the MAC address flushing method for the DHL session using the **dhl num mac-flushing** command and specify either the **raw** or **mvrp** parameter option. By default, the MAC flushing method is set to none. For example, the following command selects the MVRP method:

```
-> dhl 10 mac-flushing mvrp
```

7 Configure two links (linkA and linkB) for the DHL session using the **dhl num linka linkb** command. Specify the ports identified in Step 1 as linkA and linkB. For example:

```
-> dhl 10 linka linkagg 5 linkb port 1/1/10
```

8 Select VLANs from the set of VLANs created in Step 2 and map those VLANs to linkB using the **dhl num vlan-map linkb** command. Any VLAN not mapped to linkB is automatically mapped to linkA. By default, all VLANs are mapped to linkA. For example, the following command maps VLANs 11-20 to linkB:

```
-> dhl 10 vlan-map linkb 11-20
```

9 Administratively enable the DHL session using the **dhl num admin-state** command. For example:

```
-> dhl 10 admin-state enable
```

See [“Dual-Home Link Active-Active Example” on page 11-8](#) for a DHL application example.

Dual-Home Link Active-Active Example

The figure below shows two ports (1/1/10 and 1/1/12) that serve as link A and link B for a DHL session configured on the Edge switch. Both ports are associated with VLANs 1-10, where VLAN 1 is the default VLAN for both ports. The odd numbered VLANs (1, 3, 5, 7, 9) are mapped to link A and the even numbered VLANs (2, 4, 6, 8, 10) are mapped to link B. Spanning Tree is disabled on both ports.

Both DHL links are active and provide connectivity to the Core switches for the VLANs to which each link is mapped. If one link fails or is brought down, the VLANs mapped to the failed link are switched over to the remaining active link to maintain connectivity for those VLANs. For example, if link A goes down, VLANs 1, 3, 5, 7, and 9 are switch over and carried on link B.

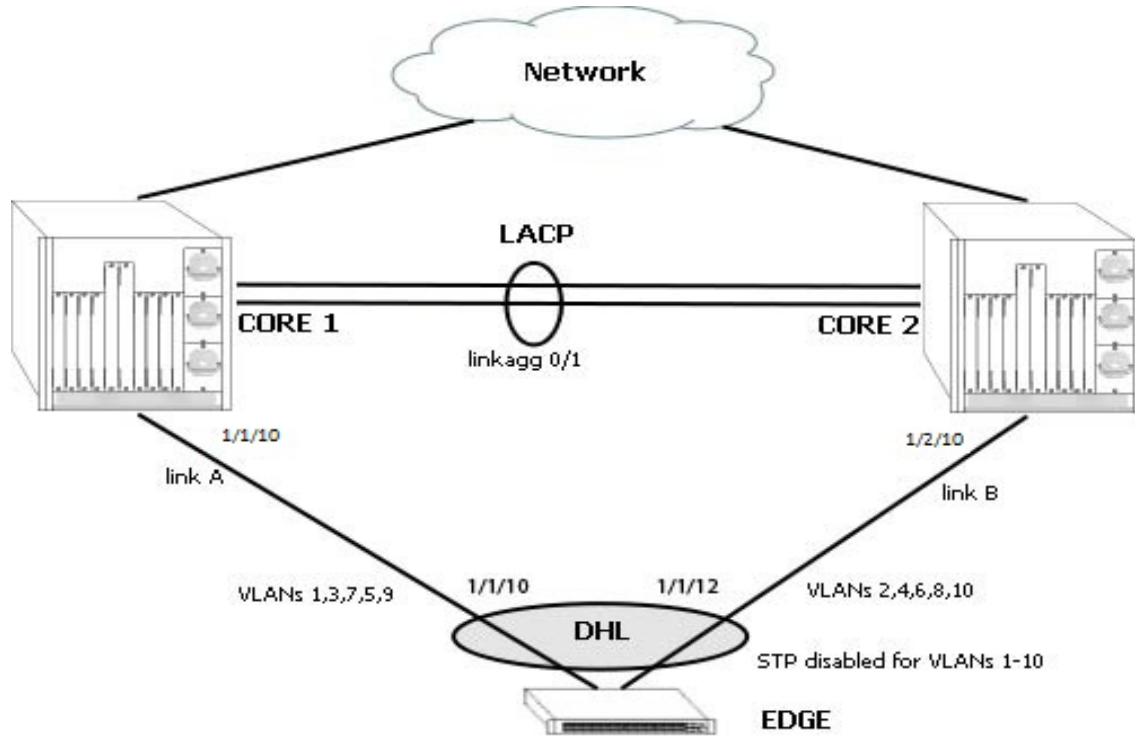

Dual-Home Link Active-Active Example

Follow the steps below to configure this example DHL configuration.

Edge Switch:

- 1 Create VLANs 2-10.

```
-> vlan 2-10
```

- 2 Configure 802.1q tagging on VLANs 2-10 for port 1/1/10. Because VLAN 1 is the default VLAN for port 1/1/10, there is no need to tag VLAN 1.

```
-> vlan 2-10 members port 1/1/10 tagged
```

- 3 Configure 802.1q tagging on the VLANs 2-10 for port 1/1/12. Because VLAN 1 is the default VLAN for port 1/1/12, there is no need to tag VLAN 1.

```
-> vlan 2-10 members port 1/1/12 tagged
```

- 4 Configure a session ID and an optional name for the DHL session.

```
-> dhl 1 name dhl_session1
```

- 5 Configure port 1/1/10 and port 1/1/12 as the dual-home links (linkA, linkB) for the DHL session.

```
-> dhl 1 linkA port 1/1/10 linkB port 1/1/12
```

- 6 Map VLANs 2, 4, 6, 8, and 10 to DHL linkB.

```
-> dhl 1 vlan-map linkb 2
-> dhl 1 vlan-map linkb 4
-> dhl 1 vlan-map linkb 6
-> dhl 1 vlan-map linkb 8
-> dhl 1 vlan-map linkb 10
```

- 7 Specify Raw Flooding as the MAC flushing technique to use for this DHL session.

```
-> dhl 1 mac-flushing raw
```

- 8 Enable the administrative state of the DHL session using the following command:

```
-> dhl 1 admin-state enable
```

Core Switches:

- 1 Create VLANs 2-10.

```
-> vlan 2-10
```

- 2 Configure 802.1q tagging on VLANs 2-10 for port 1/10 on the Core 1 switch. VLAN 1 is the default VLAN for port 1/10, so there is no need to tag VLAN 1.

```
-> vlan 2-10 members port 1/1/10 tagged
```

CLI Command Sequence Example

The following is an example of what the example DHL configuration commands look like entered sequentially on the command line:

Edge Switch:

```
-> vlan 2-10
-> vlan 2-10 members port 1/1/10 tagged
-> vlan 2-10 members port 1/1/12 tagged
-> dhl 1 name dhl_session1
-> dhl 1 linkA port 1/1/10 linkB port 1/1/12
-> dhl 1 vlan-map linkb 2
-> dhl 1 vlan-map linkb 4
-> dhl 1 vlan-map linkb 6
-> dhl 1 vlan-map linkb 8
-> dhl 1 vlan-map linkb 10
-> dhl 1 mac-flushing raw
-> dhl 1 admin-state enable
```

Core 1 Switch:

```
-> vlan 2-10
```

Core 2 Switch:

```
-> vlan 2-10
```

Recommended DHL Active-Active Topology

The following is an example of a recommended topology for Dual-Home Link Active-Active.

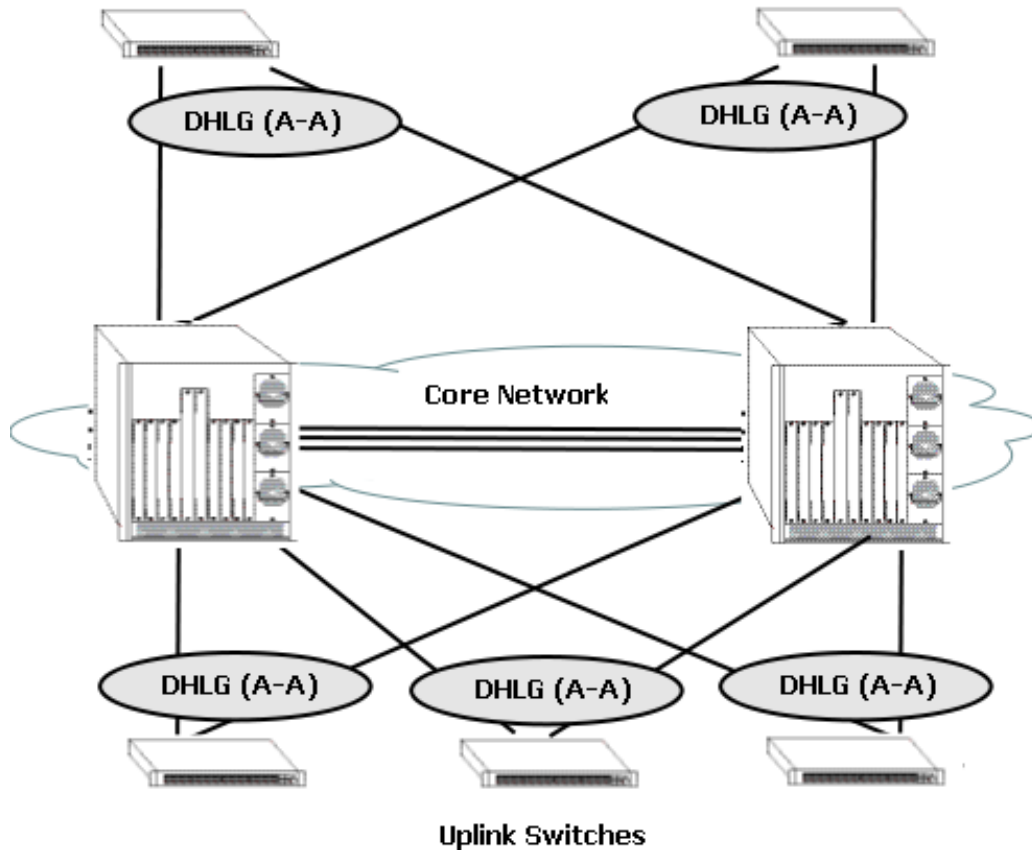

In the above topology, all uplinked switches are connected to the core network through redundant links, and the links are configured to use DHL Active-Active. Spanning Tree is disabled on all the DHL enabled ports of the uplinked devices.

Unsupported DHL Active-Active Topology (Network Loops)

The following is an example of an unsupported topology for Dual-Homed Link Active-Active.

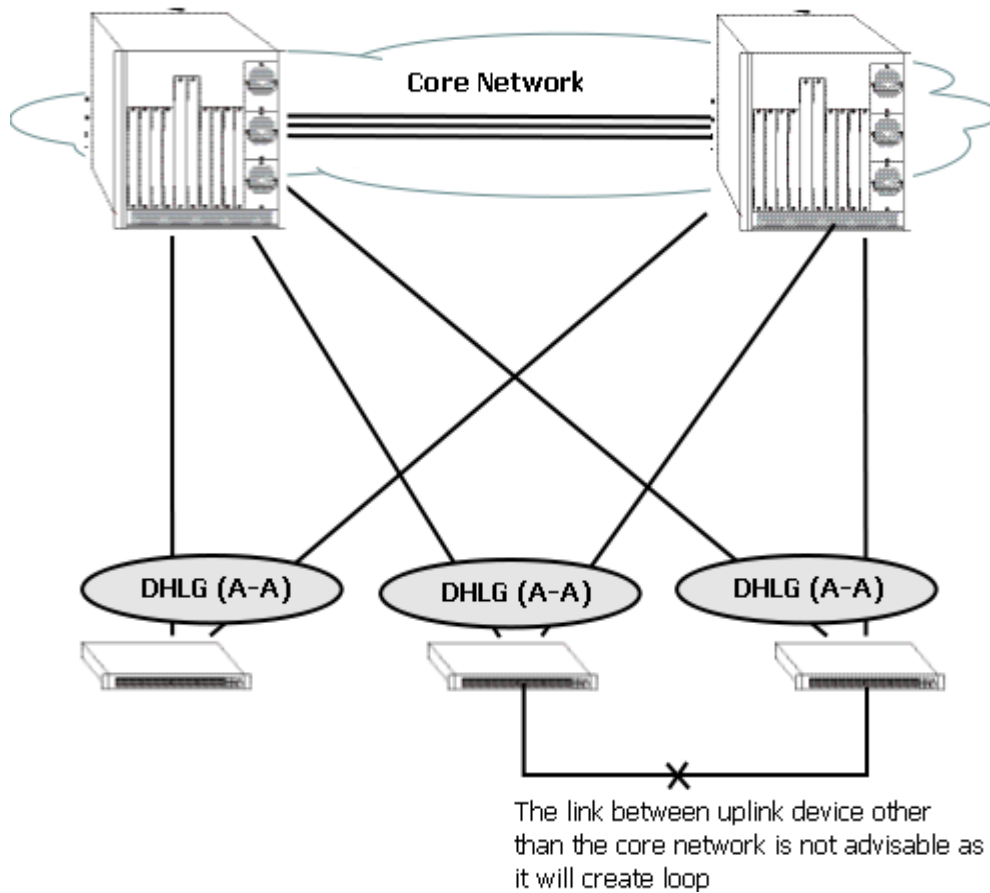

In the above topology, the link between the uplink device other than core network is not recommended as it creates a loop in the network. This topology violates the principle that uplink switches can only be connected to the network cloud through the core network.

Displaying the Dual-Home Link Configuration

You can use Command Line Interface (CLI) **show** commands to display the current configuration and statistics of link aggregation. These commands include the following:

show linkagg	Displays information on link aggregation groups.
show linkagg port	Displays information on link aggregation ports.
show dhl	Displays the global status of the DHL configuration.
show dhl num	Displays information about a specific DHL session.
show dhl num link	Displays information about a specific DHL link, for example linkA or linkB and the VLAN details of the specified link.

Note. See the “Link Aggregation Commands” chapter in the *OmniSwitch AOS Release 8 CLI Reference Guide* for complete documentation of **show** commands for link aggregation.

12 Configuring ERP

The ITU-T G.8032/Y.1344 Ethernet Ring Protection (ERP) switching mechanism is a self-configuring algorithm that maintains a loop-free topology while providing data path redundancy and network scalability. ERP provides fast recovery times for Ethernet ring topologies by utilizing traditional Ethernet MAC and bridge functions.

Loop prevention is achieved by allowing traffic to flow on all except one of the links within the protected Ethernet ring. This link is blocked and is referred to as the Ring Protection Link (RPL). When a ring failure condition occurs, the RPL is unblocked to allow the flow of traffic to continue through the ring.

Alcatel-Lucent OmniSwitch also supports ER Pv2 according to the ITU-T recommendation G.8032 03/2010. ER Pv2 implementation helps maintain a loop-free topology in multi-ring and ladder networks that contain interconnection nodes, interconnected shared links, master rings and sub-rings.

The following chapter details the different functionalities and configuration settings required for ERP and ER Pv2.

In This Chapter

This chapter provides an overview about how Ethernet Ring Protection (ERP) works and how to configure its parameters through the Command Line Interface (CLI). CLI commands are used in the configuration examples; for more details about the syntax of commands, see the *OmniSwitch AOS Release 8 CLI Reference Guide*.

The following information and configuration procedures are included in this chapter:

- [“ERP Overview” on page 12-4.](#)
- [“Interaction With Other Features” on page 12-10](#)
- [“Quick Steps for Configuring ERP with Standard VLANs” on page 12-11.](#)
- [“Quick Steps for Configuring ERP with VLAN Stacking” on page 12-12](#)
- [“ERP Configuration Overview and Guidelines” on page 12-13](#)
- [“ER Pv2 Configuration Overview and Guidelines” on page 12-18.](#)
- [“Sample Ethernet Ring Protection Configuration” on page 12-22.](#)
- [“Switch B -> erp-ring 2 enable” on page 12-25.](#)

ERP Specifications

The following table specifies the **ERP** related specifications:

Supported Platforms	OmniSwitch 6860, 6860E
ITU-T G.8032 03/2010	Ethernet Ring Protection version 2 (Multi Rings and Ladder networks supported) (Hold off timer, Lockout, Signal degrade SD, RPL Replacement, Forced Switch, Manual Switch, Clear for Manual/Forced Switch, Dual end blocking not supported)
ITU-T Y.1731/IEEE 802.1ag	ERP packet compliant with OAM PDU format for CCM
Maximum number of rings per node	64
Maximum number of nodes per ring	16 (recommended)
Maximum number of VLANs per port.	4094
Range for ring ID	1 - 2147483647
Range for remote MEPID	1 - 8191
Range for wait-to-restore timer	1 - 12 minutes
Range for guard timer	1 - 200 centi-seconds

ERP Defaults

Parameter Description	Command	Default
ERP ring status	erp-ring	Disabled
RPL status for the node	erp-ring rpl-node	Disabled
The wait-to-restore timer value for the RPL node	erp-ring wait-to-restore	5 minutes
The guard-timer value for the ring node	erp-ring guard-timer	50 centi-seconds
The NNI-SVLAN association type	ethernet-service svlan nni	STP

ERPV2 Defaults

The Ethernet Ring Protection (ERP) Ring Virtual Channel.	erp-ring virtual-channel	Enabled
Revertive mode on a specified node.	erp-ring revertive	Enabled

ERP Overview

Ethernet Ring Protection (ERP) is a protection switching mechanism for Ethernet ring topologies, such as multi-ring and ladder networks. This implementation of ERP is based on the Recommendation ITU-T G.8032/Y.1344 and uses the ring Automatic Protection Switching (APS) protocol to coordinate the prevention of network loops within a bridged Ethernet ring.

Loop prevention is achieved by allowing the traffic to flow on all but one of the links within the protected Ethernet ring. This link is blocked and is referred to as the Ring Protection Link (RPL). When a ring failure condition occurs, the RPL is unblocked to allow the flow of traffic to continue through the ring.

One designated node within the ring serves as the RPL owner and is responsible for blocking the traffic over the RPL. When a ring failure condition occurs, the RPL owner is responsible for unblocking the RPL so that the link can forward traffic to maintain ring connectivity.

The ERIPv2 capability supports multi-ring and ladder networks with interconnection nodes, interconnected shared links, master rings and sub-rings. The following features are also supported:

- R-APS Virtual Channel
- Revertive/Non-Revertive modes

A shared link can be a part of one master ring. The sub-rings connected to the interconnection nodes are open. The sub-rings cannot use shared links.

ERP and ERIPv2 Terms

Ring Protection Link (RPL) and RB—A designated link between two ring nodes that is blocked to prevent a loop on the ring. RB specifies a blocked RPL.

RPL Owner—A node connected to an RPL. This node blocks traffic on the RPL during normal ring operations and activates the link to forward traffic when a failure condition occurs on another link in the ring.

RMEPID—Remote Maintenance End Point identifier.

Link Monitoring—Ring links are monitored using standard ETH (Ethernet Layer Network) CC OAM messages (CFM). Note that for improved convergence times, this implementation also uses Ethernet link up and link down events.

Signal Fail (SF)—Signal Fail is declared when a failed link or node is detected.

No Request (NR)—No Request is declared when there are no outstanding conditions (for example, SF) on the node.

Ring APS (Automatic Protection Switching) Messages—Protocol messages defined in Y.1731 and G.8032 that determine the status of the ring.

ERP Service VLAN—Ring-wide VLAN used exclusively for transmission of messages, including R-APS messages for Ethernet Ring Protection.

ERP Protected VLAN—A VLAN that is added to the ERP ring. ERP determines the forwarding state of protected VLANs.

FDB—The Filtering Database that stores filtered data according to the R-APS messages received. This database also maintains an association table that identifies the master rings for a given sub-ring.

BPR—The Blocked Port Reference that identifies the ring port that is blocked (0 for interconnection node or sub-ring, 1 for master ring). The BPR status is used in all R-APS messages.

CCM—When an Ethernet ring contains no ERP capable nodes, CCM (Continuity Check Messages) are required to monitor the ring-port connectivity across the L2 network.

MEG and **MEL**—The switches in the Management Entity Group with given priority as MEG level (MEL).

NR and **SF**—Not Reachable and Signal Failure specify the status messages that can be sent as part of the R-APS messages.

ERP Timers

Wait To Restore (WTR) Timer. This timer is used by the RPL to verify stability of the Ethernet ring. WTR Timer determines the number of minutes the RPL switch waits before returning the RPL ports to a blocked state after the ring has recovered from a link failure.

Some important points about the WTR Timer are as follows:

- The timer is started when the RPL node receives an R-APS (NR) message that indicates ring protection is no longer required.
- The timer is stopped when the RPL owner receives an R-APS (SF) message while WTR is running, which indicates that an error still exists in the ring.
- When the time runs out, the RPL port is blocked and an R-APS (NR, RB) message is transmitted from both the ring ports to indicate that the RPL is blocked.
- Refer to the [“ERP Specifications” on page 12-2](#) for timer defaults and valid ranges.

Guard Timer. When the failed link recovers, a ring node starts the Guard Timer. The Guard Timer is used to prevent the ring nodes from receiving outdated R-APS messages that are no longer relevant.

Some important points about the Guard Timer are as follows:

- When the Guard Timer is running, any R-APS messages received are not forwarded.
- The Guard Timer value must be greater than the maximum expected forwarding delay time for which it takes one R-APS message to circulate around the ring. This calculated value is required to prevent any looping scenarios within the ring.
- Refer to the [“ERP Specifications” on page 12-2](#) for timer defaults and valid ranges.

ERP Basic Operation

ERP operates over standard Ethernet interfaces that are physically connected in a ring topology. It uses an Automatic Protection Switching (APS) protocol to coordinate protection and recovery switching mechanisms over the Ethernet ring.

In an Ethernet ring, each node is connected to two adjacent nodes using two independent links called ring links. A ring link is bound by two adjacent nodes on ports called ring ports. The ring nodes support standard FDB (Filtering database) MAC learning, forwarding, flush behavior, and port blocking and unblocking mechanisms.

The Ethernet ring has a designated Ring Protection Link (RPL), which is blocked under normal conditions in order to avoid forming a loop in the ring. When a link or port failure is detected, a Signal Failure (SF) message is sent on the ring to inform other ring nodes of the failure condition. At this point the ring is operating in protection mode. When this mode is invoked, the RPL is unblocked forming a new traffic pattern on the ring, (for example, traffic is accommodated on the RPL but blocked on the failed link). The node responsible for blocking and unblocking the RPL is called the RPL Owner.

ERP Ring Modes

A ring operates in one of two modes: idle (normal operation; all links up and RPL is blocked) and protection (protection switching activated; a ring failure has triggered the RPL into a forwarding state).

The following illustration shows an example of an ERP ring operating in the idle mode; all ring nodes are up and the RPL is blocked:

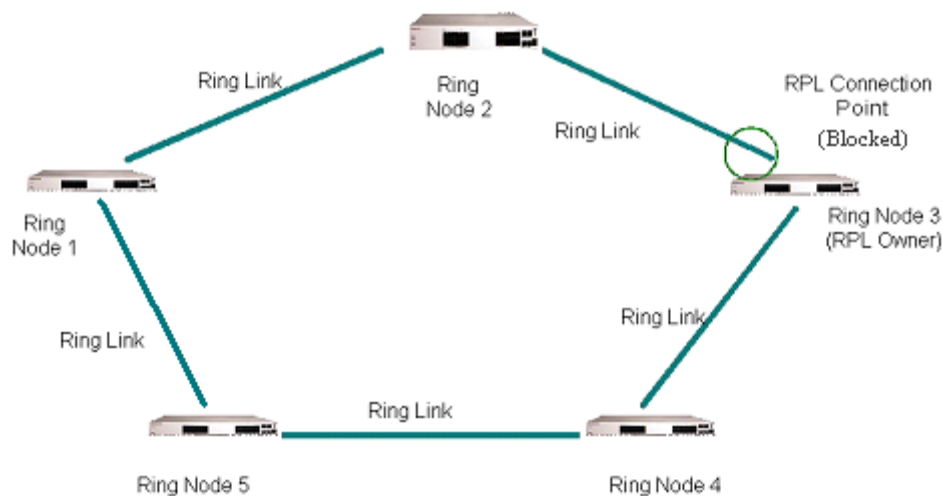

Normal Mode

If a link or node failure occurs in the ring shown in the above illustration, the ring transitions as follows into the protection mode:

- Nodes adjacent to the failure detect and report the failure using the R-APS (SF) message.
- The R-APS (SF) message triggers the RPL owner to unblock the RPL.
- All nodes in the ring flush all the dynamic MAC addresses learned on their ring ports.

The ring is now operating in the protection mode, as shown below:

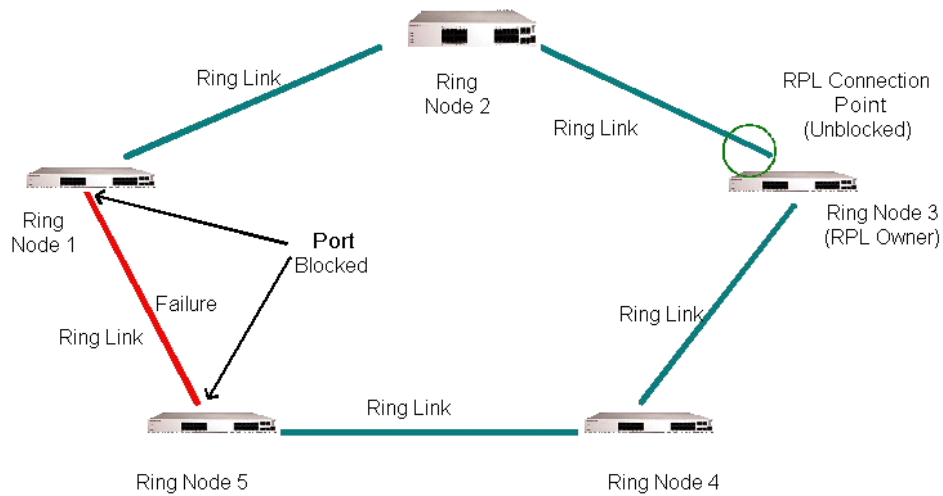

Protection Mode

When the failed link shown in the above illustration recovers, the ring transitions as follows back to the idle mode:

- Nodes adjacent to the recovered link initiate an R-APS (NR) message and start the Guard Timer.
- When the RPL owner receives the R-APS (NR) message, it starts the Wait-To-Restore timer (WTR), which is the set period of time that must elapse before the RPL owner blocks the RPL.
- Once the WTR timer expires, the RPL owner blocks the RPL and transmits an R-APS (NR, RB) message indicating that RPL is blocked (RB).
- On receiving the R-APS (NR, RB) message, ring nodes flush all the dynamic MAC addresses learned on their ring ports and unblock any previously blocked ports.
- The ring is now operating in the idle mode. The RPL is blocked and all other ring links are operational.

Overlapping Protected VLANs Between ERP Rings on same Node

In a network where all connected nodes cannot belong to a single ERP ring, the OmniSwitch supports multiple ERP rings with a single shared node. The network example below shows two ERP rings connected with a shared node.

ERPV2 Basic Operation

The enhanced ERPV2 functionality supports multi-ring and ladder networks that contain interconnection nodes, interconnected shared links, master rings and sub-rings. Multiple ERP instances are supported per physical ring.

A shared link can only be part of the master ring. The sub-rings connected to the interconnection nodes are not closed and cannot use the shared links.

Consider the following OmniSwitch multi-ring and ladder network with the Master or Major Ring with five ring nodes. The Sub-ring, ladder networks, RPLs and Shared Links are also depicted as part of the illustration.

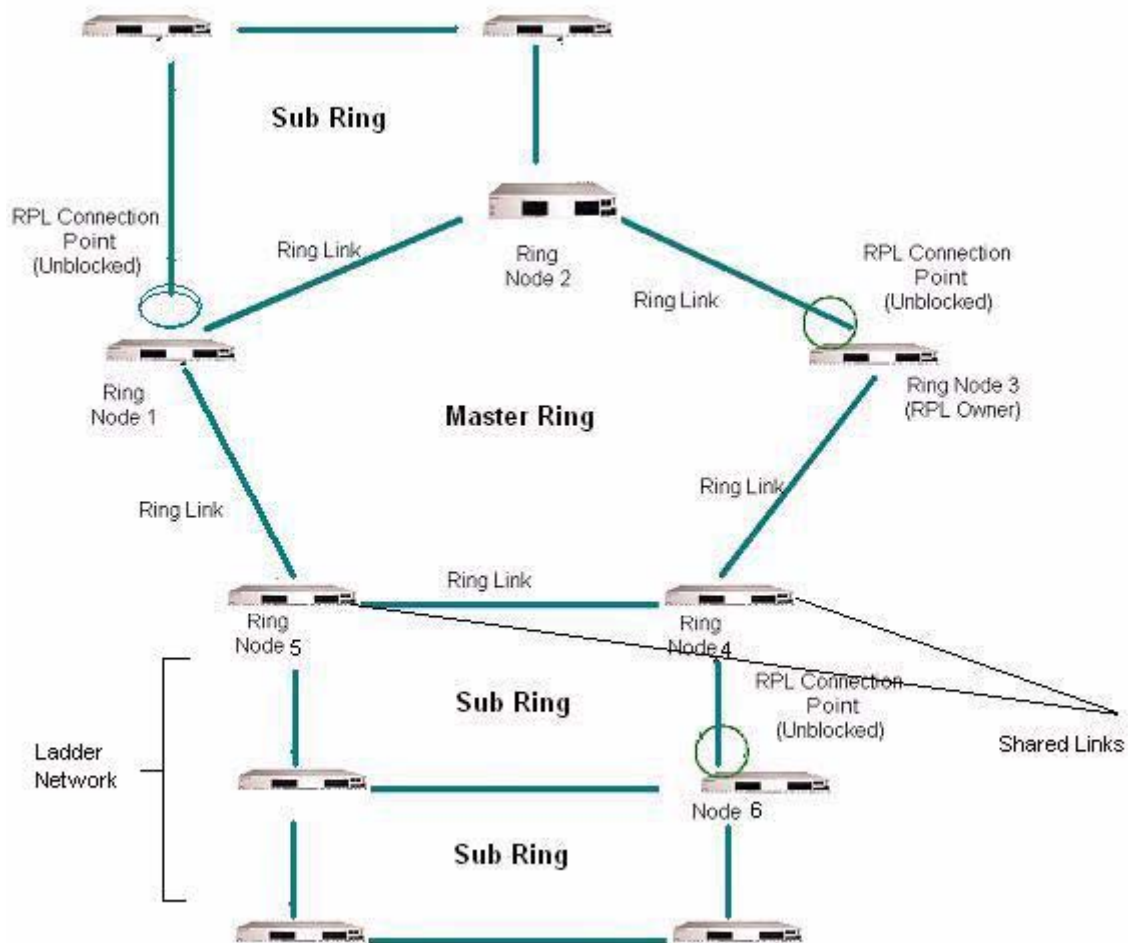

Illustration of ERPV2 on Multi Ring and Ladder Network with RPLs and Shared Links

R-APS Virtual Channel

ERPV2 supports two implementation options for R-APS control channel of the sub-ring.

- **Virtual Channel Enabled** - R-APS messages are encapsulated and transmitted over an R-APS Virtual channel configured on the major ring.
- **Virtual Channel Disabled** - R-APS messages are terminated at the interconnection nodes but not blocked at RPL of the sub-ring. RPL ports are unblocked when all nodes are active (there is no failed node).

For details on how to enable and disable R-APS virtual channel, see the section - [“Enabling and Disabling R-APS Virtual Channel” on page 12-20](#)

The R-APS channels are not shared across rings. Each ring must have its own R-APS Channel.

- The R-APS virtual channels of the sub rings are automatically **closed** using the master ring. R-APS messages from the sub ring on the interconnection node are forwarded as normal data to and only to the master ring ports.
- The R-APS messages use a static destination mac-address of 01-19-A7-00-00-00. R-APS messages must be tagged in order to identify the ring ID.

Note. The Service VLAN must be tagged, no support of "untagged" service VLAN. The sub ring and master ring cannot use the same service VLAN.

Revertive/Non-Revertive Mode

Revertive mode is configured for compatibility between ERPV1 and ERPV2 nodes in the same ring. When the ERPV2 node is operating with ERP v1 node in the same ring, it operates in revertive mode regardless of user configuration.

Non-Revertive mode: Under non-revertive mode, when the failure condition recovers, the port that has been blocked stays blocked and the unblocked RPL stays unblocked.

An exclusive clear operation can also be performed for non-revertive mode and revertive mode using the ERPV2 CLI to clear any pending state.

Untagged Service VLAN

R-APS channel can be untagged by removing VLAN type configuration check on the Service VLAN (SVLAN).

When specifying a SVLAN, the configuration must check that the ring port(s) are members of this VLAN, tagged or untagged.

The VLAN and VPAs must be created first.

Note. All the nodes and ring ports must be configured with the same default or untagged VLAN.

Example: To configure an untagged R-APS channel for ring 1, a default or untagged VLAN must be configured on the ring ports on all nodes:

```
-> vlan 4000
-> vlan 4000 members port 1/1-2 untagged
-> erp-ring 1 port1 1/1 port2 1/2 service-vlan 4000 level 2
```

Interaction With Other Features

This section contains important information about interaction of ERP with other OmniSwitch features. Refer to the specific chapter for each feature to get more detailed information about how to configure and use the feature.

Multicast

- IP multicast switching (IPMS) treats the ERP Service VLAN the same as any other configured VLAN on the switch. The ERP Service VLAN may carry data traffic, and if enabled and configured to do so, IPMS will perform regular multicast snooping on that VLAN.
- Disabling IPMS on the ERP Service VLAN is recommended if IP multicast routing or multicast snooping is enabled for the switch.

Spanning Tree

STP is automatically disabled when ERP is enabled on any port.

VLAN Stacking

ERP has the following interactions with VLAN Stacking:

- ERP is supported on Network Network Interface (NNI) ports; it is not supported on UNI ports.
- Tunneling of STP BPDUs across UNI ports is supported in a VLAN stacking configuration.

See [“Configuring ERP with VLAN Stacking NNIs” on page 12-16](#) for more information.

Source Learning

The ERP protocol determines and performs the MAC address flushing per port.

QoS Interface

The interaction between ERP and QoS is for the purpose so that R-APS PDUs can be handled appropriately by the switch.

MVRP

ERP NI must provide blocking or forwarding state of ERP ports to MVRP.

Quick Steps for Configuring ERP with Standard VLANs

The following steps provide a quick tutorial for configuring ERP.

- 1 Create a VLAN using the **vlan** command and add the ring ports.

```
-> vlan 1001
-> vlan 1001 members port 1/1/1-2 tagged
```

- 2 Create ERP ring ID 1, ERP Service VLAN and MEG Level and associate two ports to the ring using the **erp-ring** command.

```
-> erp-ring 1 port1 1/1/1 port2 1/1/2 service-vlan 1001 level 1
```

- 3 Configure the RPL on one node using the **erp-ring rpl-node** command.

```
-> erp-ring 1 rpl-node port 1/1/1
```

- 4 Create additional VLANs and add to the ring ports using the **vlan** command.

```
-> vlan 11-20
-> vlan 11-20 members port 1/1/1-2 tagged
```

- 5 Enable the ERP ring configuration using the **erp-ring enable** command.

```
-> erp-ring 1 enable
```

- 6 Display the ERP configuration using the **show erp** command.

```
-> show erp
```

Quick Steps for Configuring ERP with VLAN Stacking

The following steps provide a quick tutorial for configuring ERP with VLAN Stacking:

- 1 Create a VLAN Stacking SVLAN 1001 using the **ethernet-service svlan** command.

```
-> ethernet-service svlan 1001
```

- 2 Create a VLAN Stacking service and associate the service with SVLAN 1001 using the **ethernet-service service-name** command.

```
-> ethernet-service service-name CustomerA svlan 1001
```

- 3 Configure ports 1/1/1 and 1/1/2 as VLAN Stacking Network Network Interface (NNI) ports, associate the ports with SVLAN 1001, and configure them for use with ERP using the **ethernet-service svlan nni** command.

```
-> ethernet-service nni port 1/1/1
-> ethernet-service nni port 1/1/2
-> ethernet-service svlan 1001 nni port 1/1/1
-> ethernet-service svlan 1001 nni port 1/1/2
```

- 4 Create ERP ring ID 1 and associate the two NNI ports to the ring using the **erp-ring** command.

```
-> erp-ring 1 port1 1/1/1 port2 1/1/2 service-vlan 1001 level 5
```

- 5 Configure the RPL on one node using the **erp-ring rpl-node** command.

```
-> erp-ring 1 rpl-node port 1/1/1
```

- 6 Create additional SVLANs and add to the ring ports using the **ethernet-service svlan** command.

```
-> ethernet-service svlan 1002
-> ethernet-service svlan 1003
-> ethernet-service svlan 1002 nni port 1/1/1-2
-> ethernet-service svlan 1002 nni port 1/1/2-2
```

- 7 Enable the ERP ring configuration using the **erp-ring enable** command.

```
-> erp-ring 1 enable
```

- 8 Display the ERP configuration using the **show erp** command.

```
-> show erp
```

ERP Configuration Overview and Guidelines

Configuring ERP requires several steps. These steps are outlined here and further described throughout this section. For a brief tutorial on configuring ERP, see [“Quick Steps for Configuring ERP with Standard VLANs” on page 12-11.](#)

By default, ERP is disabled on a switch. Configuring ERP consists of these main tasks:

- 1** Configure the basic components of an ERP ring (ring ports, service VLAN, and MEG level). See [“Configuring an ERP Ring” on page 12-14.](#)
- 2** Tag VLANs for ring protection. See [“Adding VLANs to Ring Ports” on page 12-14.](#)
- 3** Configure an RPL port. When a ring port is configured as an RPL port, the node to which the port belongs becomes the RPL owner. The RPL owner is responsible for blocking and unblocking the RPL. See [“Configuring an RPL Port” on page 12-15.](#)
- 4** Change the Wait-To-Restore timer value. This timer value determines how long the RPL owner waits before restoring the RPL to a forwarding state. See [“Setting the Wait-to-Restore Timer” on page 12-15.](#)
- 5** Change the Guard timer value. This timer value determines an amount of time during which ring nodes ignore R-APS messages. See [“Setting the Guard Timer” on page 12-15.](#)
- 6** Configure the ring port to receive the loss of connectivity event for a Remote Ethernet OAM endpoint. See [“Configuring ERP with VLAN Stacking NNIs” on page 12-16.](#)
- 7** Configure a VLAN Stacking NNI-to-SVLAN association for ERP control. This is done to include an SVLAN in a ring configuration. See [“Configuring ERP with VLAN Stacking NNIs” on page 12-16.](#)
- 8** Clear ERP statistics. Commands to clear ERP statistics for a single ring or multiple rings are described in [“Clearing ERP Statistics” on page 12-17.](#)

Configuration Guidelines

Use the following guidelines when configuring ERP for the switch:

- Physical switch ports and logical link aggregate ports can be configured as ERP ring ports. This also includes VLAN Stacking Network Network Interface (NNI) ports.
- ERP is *not* supported on mobile ports, mirroring ports, link aggregate member ports, multicast VLAN receiver ports (ERP is supported on Multicast VLAN sender ports only), or VLAN Stacking User Network Interface (UNI) ports.
- An ERP ring port can belong to only one ERP ring at a time.
- STP is automatically disabled when ERP is enabled on any port.
- If the ERP switch participates in an Ethernet OAM MaintenanceDomain(MD), configure the Management Entity Group (MEG) level of the ERP service VLAN with the number that is used for the Ethernet OAM MD.
- The Service VLAN can belong to only one ERP ring at a time and must be a static VLAN. Note that the service VLAN is also a protected VLAN.

Configuring an ERP Ring

The following configuration steps are required to create an ERP ring:

- 1 Determine which two ports on the switch are the ring ports. For example, ports 1/1/1 and 1/1/2.
- 2 Determine which VLAN on the switch is the ERP service VLAN for the ring. If the VLAN does not exist, create the VLAN. For example:

```
-> vlan 500
```

- 3 Create the ERP ring configuration on each switch using the **erp-ring** command. For example the following command configures an ERP ring with ring ID 1 on ports 1/1/1 and 1/1/2 along with service VLAN 500 and MEG level 1.

```
-> erp-ring 1 port1 1/1/1 port2 1/1/2 service-vlan 500 level 1
-> erp-ring 1 enable
```

To configure link aggregate logical ports as ring ports, use the **erp-ring** command with the **linkagg** parameter. For example:

```
-> erp-ring 1 port1 linkagg 1 port2 linkagg 2 service-vlan 500 level 1
-> erp-ring 1 enable
```

- 4 Repeat Steps 1 through 6 for each switch that participates in the ERP ring. Make sure to use the same VLAN ID and MEG level for the service VLAN on each switch.

Use the **show erp** command to verify the ERP ring configuration. For more information about this command, see the *OmniSwitch AOS Release 8 CLI Reference Guide*.

Removing an ERP Ring

To delete an ERP ring from the switch configuration, use the **no** form of the **erp-ring** command. For example:

```
-> no erp-ring 1
```

Note. Administratively disable ring ports before deleting the ring to avoid creating any network loops. Once a ring is deleted, then administratively enable the ports under Spanning Tree protocol.

Adding VLANs to Ring Ports

ERP allows a single VLAN or a number of VLANs to participate in a single ERP ring. The **vlan members untagged** command is used to tag the ring ports of the ERP ring with a VLAN ID.

To add a VLAN or range of VLANs to ring ports use the **vlan members untagged** command.

```
-> vlan 12-20
-> vlan 12-20 members port 1/1/1 tagged
-> vlan 12-20 members port 1/1/2 tagged
```

Configuring an RPL Port

A ring protection link (RPL) port can be a physical or logical port. The port must be a ring port before it is configured as an RPL port, and out of the two ring ports on the node, only one can be configured as a RPL port. The RPL remains blocked to prevent loops within the ERP ring.

To configure an RPL port, first disable the ring and then use the **erp-ring rpl-node** command to specify which ring port serves as the RPL. For example:

```
-> erp-ring 1 disable
-> erp-ring 1 rpl-node port 1/1/1
-> erp-ring 1 enable
```

Note. RPL node can be configured only when the ring is disabled; RPL configuration applied to the ring while it is enabled is rejected.

To remove the RPL node configuration for the specified ring, use the **no** form of the **erp-ring rpl-node** command. For example:

```
-> no erp-ring 1 rpl-node
```

To verify the RPL node configuration for the switch, use the **show erp** command. For more information about this command, see the *OmniSwitch AOS Release 8 CLI Reference Guide*.

Setting the Wait-to-Restore Timer

The wait-to-restore (WTR) timer determines the number of minutes the RPL owner waits before blocking the RPL port after the ERP ring has recovered from a link failure.

By default, the WTR time is set to five minutes. To change the value of the WTR timer, use the **erp-ring wait-to-restore** command. For example:

```
-> erp-ring 1 wait-to-restore 6
```

The above command is only used on a switch that serves as the RPL node for the ERP ring. The specified ERP ring ID must already exist in the switch configuration.

To restore the timer back to the default setting, use the **no** form of the **erp-ring wait-to-restore** command. For example:

```
-> no erp-ring 1 wait-to-restore
```

To verify the WTR configuration, use the **show erp** command. For more information about this command, see the *OmniSwitch AOS Release 8 CLI Reference Guide*.

Setting the Guard Timer

The guard timer is used to prevent the ring nodes from receiving outdated R-APS messages, which are no longer relevant. Receiving outdated R-APS messages could result in incorrect switching decisions. During the amount of time determined by this timer, all received R-APS messages are ignored by the ring protection control process.

By default, the guard timer value is set to 50 centi-seconds. To change the value of this timer, use the **erp-ring guard-timer** command. For example:

```
-> erp-ring 1 guard-timer 100
```

To restore the Guard Timer back to the default value, use the no form of the `erp-ring guard-timer` command. For example:

```
-> no erp-ring 1 guard-timer
```

To verify the configured Guard Timer, use the `show erp` command. For more information about this command, see the *OmniSwitch AOS Release 8 CLI Reference Guide*.

Configuring ERP with VLAN Stacking NNIs

A VLAN Stacking Network Network Interface (NNI) can participate in an ERP ring. However, an NNI is created through an association of a port with an SVLAN. Both STP and ERP cannot control the same VLAN-port association (VPA). By default, the NNI to SVLAN association is controlled by STP.

To include an NNI in an ERP ring, specify ERP control at the time the NNI association is configured. This is done using the `erp` parameter of the `ethernet-service svlan nni` command. For example:

```
-> ethernet-service svlan 1001 nni port 1/1/1
-> ethernet-service svlan 1001 nni port 1/1/2
```

The above commands configure ports 1/1/1 and 1/1/2 as NNI ports for SVLAN 1001. Note that the SVLAN specified must already exist in the switch configuration.

To configure an ERP ring with NNI-SVLAN associations, use the `erp-ring` command but specify an SVLAN ID for the service VLAN and the associated NNI ports as the ring ports. For example:

```
-> erp-ring 1 port1 1/1/1 port2 1/1/2 service-vlan 1001 level 2
-> erp-ring 1 enable
```

Note the following when configuring an ERP ring with VLAN Stacking NNI-SVLAN associations:

- Only two ERP type NNI associations are allowed per SVLAN.
- Configuring an ERP ring on 802.1q tagged port associations with SVLANs is not allowed.
- Configuring an ERP Ring on an STP type NNI association with an SVLAN is not allowed.
- Configuring an IMPVLAN as an ERP service VLAN is not allowed.
- If an SVLAN that is not associated with any NNI ports is configured as the service VLAN for an ERP ring, the NNI ring ports are automatically associated with that SVLAN at the time the ring is created.
- SVLAN User Network Interface (UNI) associations are not eligible for ERP ring protection.
- If the ERP type NNI ports are connected to the STP path through UNI ports, then STP BPDUs can be tunneled with the help of VLAN-stacking mechanism.
- Deleting an ERP service VLAN and its associated NNI ports is only allowed when the ERP ring itself is deleted using the `no` form of the `erp-ring` command. None of the VLAN Stacking CLI commands can remove a service VLAN consisting of an NNI-SVLAN association.

Configuring ERP Protected SVLANs

An SVLAN becomes an ERP protected SVLAN when the SVLAN is associated with two NNI ports that also serve as ring ports. In this case, the SVLAN is automatically protected as part of the association with NNI ring ports.

The following sequence of configuration commands provides an example of how SVLANs are automatically added as protected SVLANs to an ERP ring:

```
-> ethernet-service svlan 100
-> ethernet-service svlan 200
-> ethernet-service svlan 300
-> ethernet-service svlan 400
-> ethernet-service svlan 100 nni port 1/1/1-2
-> ethernet-service svlan 200 nni port 1/1/1-2
-> ethernet-service svlan 300 nni port 1/1/1-2
-> erp-ring 10 port1 1/1/1 port2 1/1/2 service-vlan 400 level 1
```

In the above example:

- SVLANs 100, 200, and 300 are automatically added as protected VLANs when the ring is created. This is due to the NNI ports being part of ERP ring 10.
- SVLAN 400 is also automatically added as a protected VLAN when it is configured as the service VLAN for the ring.

Use the **show erp** command to verify the configured VLAN Stacking ERP ring configuration. For more information about these commands, see the *OmniSwitch AOS Release 8 CLI Reference Guide*.

Clearing ERP Statistics

To clear ERP statistics for all rings in the switch, use the **clear erp statistics** command. For example:

```
-> clear erp statistics
```

To clear ERP statistics for a specific ring in the switch, use the **clear erp statistics** command with the **ring** parameter to specify a ring ID. For example:

```
-> clear erp statistics ring 5
```

To clear ERP statistics for a specific ring port, use the **clear erp statistics** command with the **ring** and **port** parameters. For example:

```
-> clear erp statistics ring 5 port 1/1/2
```

To clear ERP statistics for a specific link aggregate ring port, use **clear erp statistics** command with the **ring** and **linkagg** parameters. For example:

```
-> clear erp statistics ring 5 linkagg 2
```

Use the **show erp statistics** command to verify ERP statistics. For more information about this command, see the *OmniSwitch AOS Release 8 CLI Reference Guide*.

ERPV2 Configuration Overview and Guidelines

The following section details the guidelines and prerequisites for configuring ERPv2 and details on how to configure the ERPv2 related parameters using OmniSwitch CLI. Configuring the sample ERPv2 ring network involves the following tasks:

- 1** *Optional*: Configure tagged ports or link aggregate ports before configuring ERP.
- 2** Configure an ERP ring with same ERP ring ID on all switches in the network.
- 3** Define same ERP Service VLAN on all switches.
- 4** Set the same Management Entity Group (MEG) (for example, level 2) for all switches.
- 5** Assign one switch to be the RPL owner. Configure the port connected to the Ring Protection Link as an RPL port.
- 6** Enable the configured ERPv2 ring.
- 7** Assign separate VLANs as protected VLANs to the ERP ring.
- 8** Use the default settings for the guard timer and WTR timer values. These values can be adjusted as necessary.

The following sub-sections provide the details on prerequisites and different configurations for switches to set up an ERPv2 ring network, using Alcatel-Lucent OmniSwitch CLI commands.

Major and Sub Ring Management

A shared link must be configured only on the major ring.

The following conditions must be considered for configuring an ERPv2 port for a shared link:

- Sub-rings can not be closed using a shared link.
- An SVLAN must exist before an ERP ring is created and must be unique per ring.
- A given port can only be configured on one ring.
- Each ring must have its own RPL.
- The RPL can be placed anywhere on the major ring including the shared links.
- The RPL can be placed anywhere on the sub-rings, including the sub-ring-port. Since the sub-ring is not closed using the shared link, the RPL cannot be placed on the shared link.

Configuration Parameters

The following conditions must be considered before configuring an ERPv2 port:

- A given port can only be configured on one ring.
- The shared links are only configurable on the Master Ring.
- The Sub Rings cannot be closed using the shared links.
- Each ring must have its own RPL.

- The RPL can be placed anywhere on the Master Ring, including the shared links.
- The RPL can be placed anywhere on the Sub Rings, including the only ring port of the interconnection nodes. Since the sub-ring is not closed using the shared link, the RPL cannot be placed on the shared link.

ERPV2 Ring Sample Configuration

A master ring can be configured using the following command:

```
Switch 1-> erp-ring 1 port1 1/1/1 port2 1/1/2 service-vlan 10 level 2
```

A sub-ring on the non-interconnection node can be configured using the following command:

```
Switch 2-> erp-ring 2 port1 1/1/1 port2 1/1/3 service-vlan 10 level 2
```

A sub ring on the interconnection node can be configured using the following command:

```
Switch 3-> erp-ring 3 sub-ring-port 1/1/3 service-vlan 10 level 2
```

Sample Switch Configuration

The following configurations must be performed on each switch in the ERPv2 Ring network:

Step 1: Create the Service VLAN and add to ring ports.

```
-> vlan 10
-> vlan 200
-> vlan 10 members port 1/1/3 tagged
-> vlan 10 members port 1/1/5 tagged
-> vlan 200 members port 1/1/6 tagged
```

Step 2: Create the rings.

```
-> erp-ring 1 port1 1/1/5 port2 1/1/3 service-vlan 10 level 1
-> erp-ring 2 sub-ring-port 1/1/6 service-vlan 200 level 1
```

Step 3: Create traffic VLANs and add to ring ports as necessary using VM commands

```
-> vlan 100-400
-> vlan 100-300 members port 1/1/5 tagged
-> vlan 100-300 members port 1/1/3 tagged
-> vlan 201-400 members port 1/1/6 tagged
```

Step 4 : Enable the rings.

```
-> erp-ring 1 enable
-> erp-ring 2 enable
```

Note. The traffic VLANs could be added or deleted as needed at any time during the configuration.

Enabling and Disabling R-APS Virtual Channel

User can enable and disable virtual channel. By default, R-APS virtual channel is enabled.

Enabling R-APS Virtual Channel

Enable R-APS virtual channel using the following command:

```
-> erp-ring 2 virtual-channel enable
```

R-APS messages from the sub-ring on the interconnection node are forwarded as normal data to the major ring ports. A node is identified as interconnection node when at least one ring is configured with a sub-ring-port.

R-APS messages from the sub-ring are tagged with the sub-ring SVLAN, are forwarded to the major ring member ports of this SVLAN.

Note. All the ring ports in major ring must be member of the sub-ring SVLAN to support R-APS virtual channel.

Interconnection Node of the Sub-Ring

When R-APS virtual channel is enabled, on the interconnection node of a sub-ring, all the R-APS messages received from sub-ring port are processed and flooded to major ring ports that are the member of the VLAN used by R-APS message.

For example,

```
-> erp-ring 3 virtual-channel enable
```

Other nodes of the Sub-Ring

When enabled, R-APS messages received on blocked port are processed but not forwarded to the other ring port.

Disabling R-APS Virtual Channel

Disable R-APS virtual channel using the following command:

```
-> erp-ring 2 virtual-channel disable
```

Now, R-APS messages from the sub-ring on the interconnection node are not forwarded to any other ports. R-APS messages are forwarded even on the blocked ports in the sub-ring. A configuration object is required for the sub-ring to disable the R-APS virtual channel.

Interconnection Node of the Sub-Ring

When virtual channel is disabled, R-APS message received from sub-ring ports are processed but not flooded to major ring.

For example,

```
-> erp-ring 3 virtual-channel disable
```

Other nodes of the Sub-Ring

When virtual channel is disabled, R-APS messages received on blocked port are processed and forwarded to other ring port.

Note. Virtual channel configuration must be consistent among all nodes of the sub-ring.

Enabling or Disabling Revertive Mode

Revertive mode is enabled by default. You can disable revertive mode by setting the following command:

```
-> erp-ring 2 revertive enable
```

You can enable revertive mode by setting following command:

```
-> erp-ring 2 revertive disable
```

Non-revertive Mode

Under non-revertive mode, when the failure recovers, the blocked port stays blocked and the unblocked RPL stays unblocked. Revertive mode is enabled by default. Operator can enable non-revertive mode by setting following command.

When the ERPV2 node is operating with ERPV1 node in the same ring, it operates in different way for compatibility. In this mode, revertive mode is always assumed, it operates in revertive mode regardless of user configuration.

```
-> erp-ring 2 revertive disable
```

Clear Non-revertive and Revertive Mode

When the ring is in the No Request (NR) state and the blocked port is not the RPL port, the operator must be allowed to trigger the reversion to the initial state of the ring (make the RPL port blocked).

This situation happens in 2 cases:

- The ring is set in a non-revertive mode.
- The ring is set in a revertive mode but the WTR timer has not expired.

The CLI command is as follows:

```
-> erp-ring 2 clear
```

The command can only be issued on the RPL owner node and when the ring is in the NR state and WTR timer not expired or no WTR (non-revertive mode)

When the command is accepted, the RPL owner node blocks its RPL port, and transmits an R-APS (NR, RB) message in both directions. Upon receiving the R-APS (NR, RB), each node unblocks its blocking ports and performs a flush operation when applicable.

Sample Ethernet Ring Protection Configuration

This section provides an example network configuration in which ERP is configured on network switches to maintain a loop-free topology. In addition, a tutorial is also included that provides steps on how to configure the example network topology using the Command Line Interface (CLI).

Example ERP Overview

The following diagram shows a five-switch ERP ring configuration:

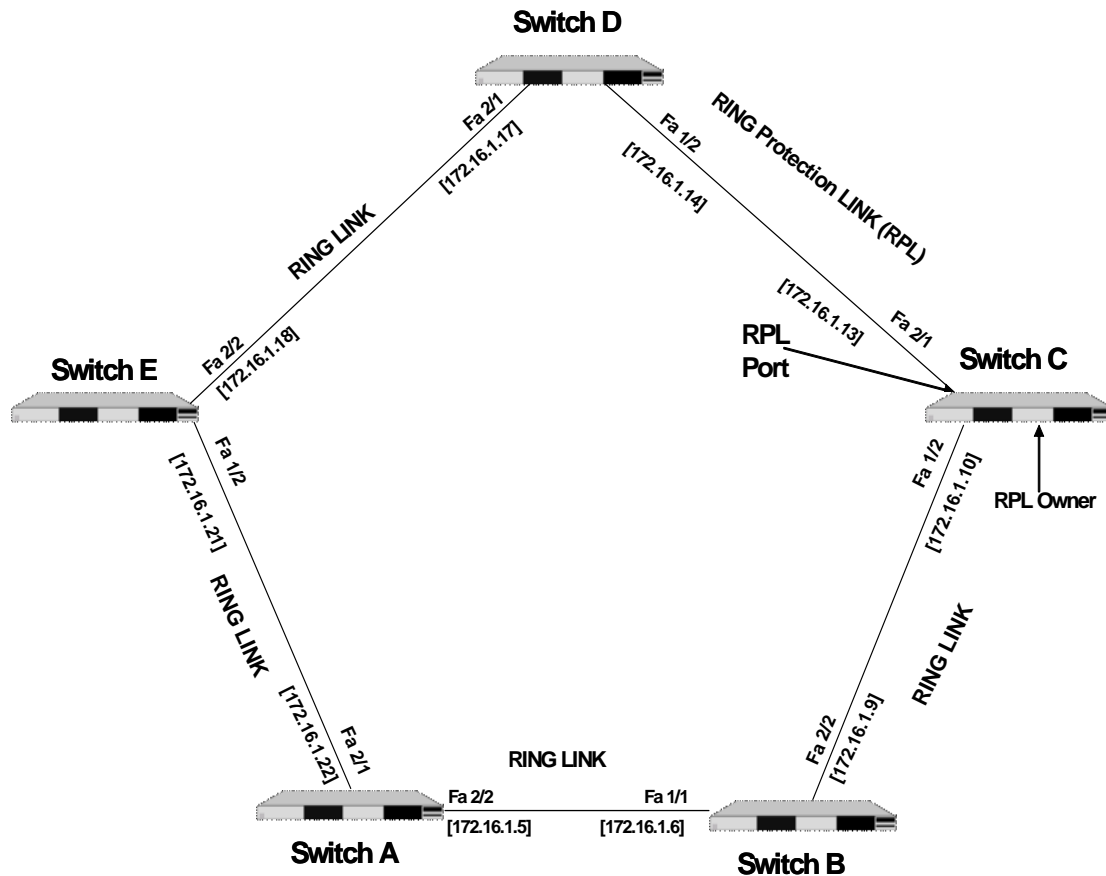

Configuring the sample ERP ring network shown in the above diagram involves the following tasks:

- 1 Configure an ERP ring with ERP ring ID 1 on all switches in the network.
- 2 Define an ERP Service VLAN as VLAN 10 on all switches.
- 3 Set the Management Entity Group (MEG) level to 2 for all switches.
- 4 Switch C is the RPL owner; configure the port connected to the Ring Protection Link as a RPL port.
- 5 Enable the configured ERP ring.
- 6 Assign VLANs 11-20 as a protected VLANs to ERP ring 1.
- 7 Use the default settings for the guard timer and WTR timer values. These values can be adjusted as necessary.

Example ERP Configuration Steps

The following steps provide a quick tutorial for configuring the ERP ring network shown in the diagram on [page 12-22](#):

1 Configure ERP ring 1 and add protected VLANs 11 through 20 on Switch A, B, C, D, and E using the following commands:

```
-> vlan 10
-> vlan 10 members port 2/1-2 tagged
-> erp-ring 1 port1 2/1 port2 2/2 service-vlan 10 level 2
-> erp-ring 1 enable
-> vlan 11-20 members port 2/1-2 tagged
```

2 Configure Switch C as the RPL owner for the ring using the following commands to designate port 2/1 as the RPL port:

```
-> erp-ring 1 disable
-> erp-ring 1 rpl-node port 2/1
-> erp-ring 1 enable
```

3 Verify the ERP ring configuration on any switch using the following command:

```
-> show erp ring 1
Legend: * - Inactive Configuration

Ring Id           : 1,
Ring Port1        : 2/1,
Ring Port2        : 1/2,
Ring Status       : enabled,
Service VLAN      : 10,
WTR Timer (min)   : 5,
Guard Timer (centi-sec) : 50,
MEG Level         : 2,
Ring State        : idle,
Ring Node Type    : rpl,
RPL Port          : 2/1,
Last State Change : SUN DEC 25 06:50:17 2016 (sysUpTime 00h:01m:31s)
```

The above output example shows that ERP ring 1 is created on ring ports 2/1 and 1/2 with service VLAN 10, WTR timer of 5 mins, Guard timer of 50 centi-seconds, MEG level 2, and port 2/1 is the RPL port.

4 Verify the status of an ERP ring port on any switch using the following command:

```
-> show erp port 1/2
Legend: * - Inactive Configuration

Ring-Id : 1
Ring Port Status      : forwarding,
Ring Port Type        : non-rpl,
Ethoam Event          : disabled
```

The above command shows the forwarding status of the port, the type of ring port (RPL or non-RPL), and ETHOAM event status.

Sample ERPV2 Ring Configuration

This section provides an example network configuration in which ERPV2 is configured on network switches to maintain a loop-free topology. In addition, a tutorial is also included that provides steps on how to configure the example network topology using the Command Line Interface (CLI).

Example ERPV2 Overview

The following diagram shows a seven-switch ERPV2 ring configuration when R-APS virtual channel is enabled.

The topology of the network is as follows:

- Switches A, B, C, D, and E for the Major Ring.
- Switch A and B form a shared link.
- Switch B is configured to be the main RPL node.
- Switches A, B, F, and G form the Sub Ring.

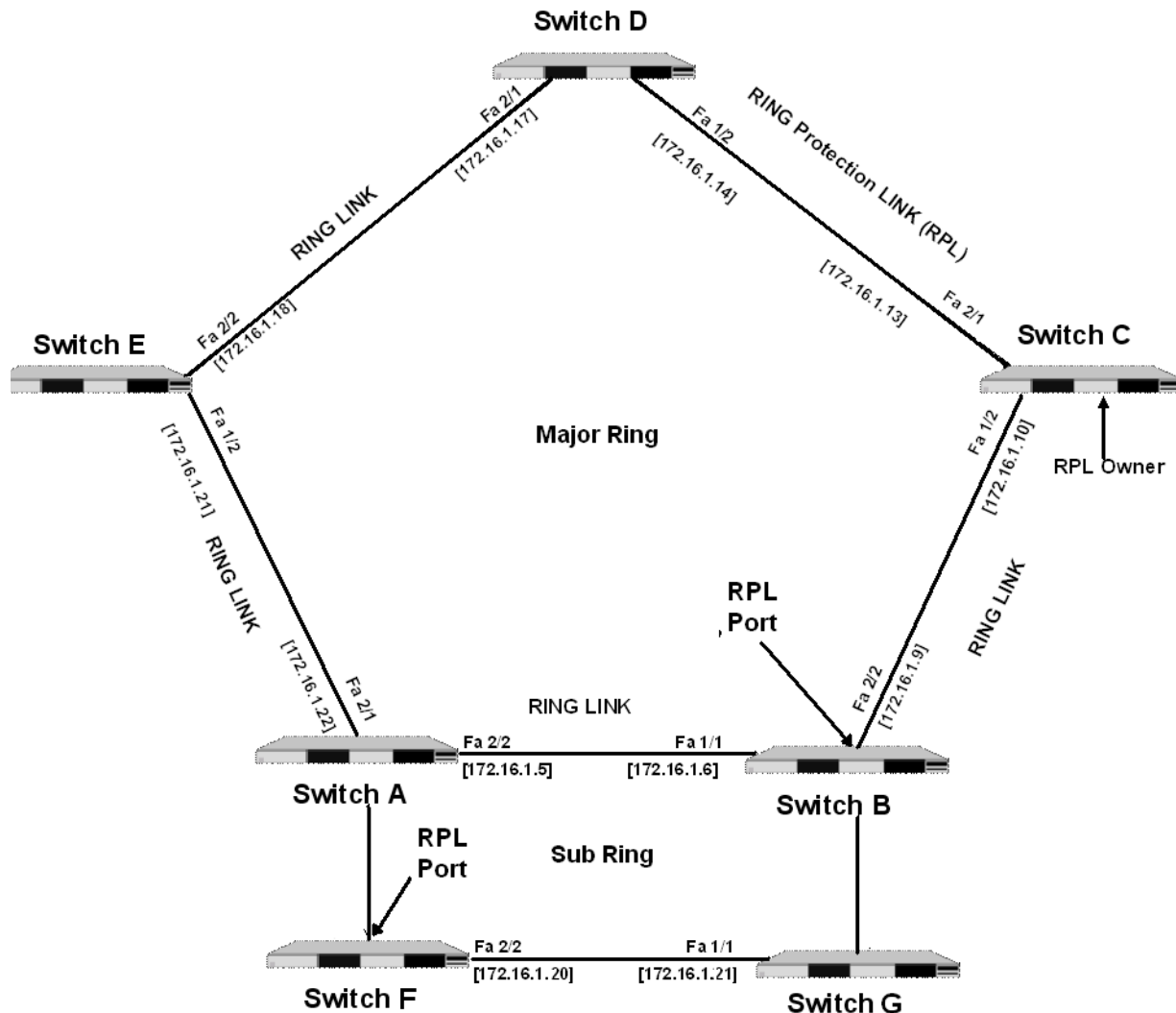

The following sub-sections provide the details on prerequisites and different configurations for switches to set up an ERIPv2 ring network, using Alcatel-Lucent OmniSwitch CLI commands.

Configuring Shared Link

The following configuration steps must be performed on Switch A and Switch B.

Step 1: Create the Service VLAN and add to ring ports on Switch A and B that are part of a shared link:

```
Switch A -> vlan 10
Switch A -> vlan 200
Switch A -> vlan 10 members port 2/1 tagged
Switch A -> vlan 10 members port 2/2 tagged
Switch A -> vlan 200 members port 1/6 tagged

Switch B -> vlan 10
Switch B -> vlan 200
Switch B -> vlan 10 members port 1/1 tagged
Switch B -> vlan 10 members port 2/2 tagged
Switch B -> vlan 200 members port 1/6 tagged
```

Step 2: Create the ERP rings 1 and 2 on Switch A.

```
Switch A -> erp-ring 1 port1 2/1 port2 2/2 service-vlan 10 level 1
Switch A -> erp-ring 2 sub-ring-port 1/6 service-vlan 200 level 1
```

Step 3: Create traffic VLANs and add to ring ports as necessary using VM commands on Switch A.

```
Switch A -> vlan 100-400
Switch A -> vlan 100-300 members port 2/1 tagged
Switch A -> vlan 100-300 members port 2/2 tagged
Switch A -> vlan 201-400 members port 1/6 tagged
```

Step 4: Enable the rings on Switch A.

```
Switch A -> erp-ring 1 enable
Switch A -> erp-ring 2 enable
```

Configuring Main RPL Node

Main RPL is configured on Switch B. The following configurations must be performed on Switch B.

Step 1: Create the ERP rings 1 and 2 on Switch B.

```
Switch B -> erp-ring 1 port1 1/1 port2 2/2 service-vlan 10 level 1
Switch B -> erp-ring 2 sub-ring-port 1/6 service-vlan 2000 level 1
```

Step 2: Configure Switch B as RPL Node using the **erp-ring epl-node** command:

```
Switch B -> erp-ring 1 epl-node 2/2
```

Step 3: Enable the rings on Switch B.

```
Switch B -> erp-ring 1 enable
Switch B -> erp-ring 2 enable
```

Step 4: Create traffic VLANs and add to ring ports as necessary Switch B.

```
Switch B -> vlan 100-400
Switch B -> vlan 100-300 members port 1/1 tagged
```

```
Switch B -> vlan 100-300 members port 2/2 tagged
Switch B -> vlan 201-400 members port 1/6 tagged
```

Configuring Switches in Main Ring

The following configuration steps must be performed on Switch C, D, and E

```
-> vlan 10
-> vlan 10 members port 1/2 tagged
-> vlan 10 members port 2/1 tagged
-> erp-ring 1 port1 1/2 port2 2/1 service-vlan 10 level 1
-> vlan 100-300
-> erp-ring 1 enable
-> vlan 100-300 members port 1/2 tagged
-> vlan 100-300 members port 2/1 tagged
```

Configuring Secondary RPL Node

The following configurations must be performed on Switch F in the ERPV2 Ring network:

```
-> vlan 200-400
-> vlan 200-400 members port 1/6 tagged
-> vlan 200-400 members port 2/2 tagged
-> erp-ring 2 port1 1/6 port2 2/2 service-vlan 200 level 1
-> erp-ring 2 rpl-node 1/6
-> erp-ring 2 enable
```

Configuring Switch in Sub Ring

The following configurations must be performed on Switch G in the ERPV2 Ring network:

```
-> vlan 200-400
-> vlan 200-400 members port 1/1 tagged
-> vlan 200-400 members port 1/6 tagged
-> erp-ring 2 port1 1/1 port2 1/6 service-vlan 200 level 1
-> erp-ring 2 enable
```

Verifying the ERP Configuration

A summary of the **show** commands used for verifying the ERP configuration is given here:

show erp	Displays the ERP configuration information for all rings, a specific ring, or for a specific ring port.
show erp statistics	Displays the ERP statistics for all rings, a specific ring, or a specific ring port.
show ethernet-service	Displays configuration information for VLAN Stacking Ethernet services, which includes SVLANs and NNI port associations.
show ethernet-service nni	Displays the VLAN Stacking NNI configuration.
show ethernet-service vlan	Displays a list of SVLANs configured for the switch.

For more information about the displays that result from these commands, see the *OmniSwitch AOS Release 8 CLI Reference Guide*.

13 Configuring MVRP

Multiple VLAN Registration Protocol (MVRP) is a standards-based Layer 2 network protocol for automatic configuration of VLAN information on switches. It was defined in the 802.1ak amendment to 802.1Q-2005.

MVRP provides a method to share VLAN information and configure the needed VLANs within a Layer 2 network. For example, in order to add a switch port to a VLAN, only the end port, or the VLAN-supporting network device connected to the switch port, must be reconfigured, and all necessary VLAN trunks are dynamically created on the other MVRP-enabled switches. MVRP helps to maintain VLAN configuration dynamically based on current network configurations.

In This Chapter

This chapter describes the MVRP feature and how to configure it through the Command Line Interface (CLI). CLI commands are used in the configuration examples; for more details about the syntax of commands, see the *OmniSwitch AOS Release 8 CLI Reference Guide*. This chapter provides an overview of MVRP and includes the following information:

- [“Enabling MVRP” on page 13-7](#)
- [“Configuring the Maximum Number of VLANs” on page 13-7](#)
- [“Configuring MVRP Registration” on page 13-8](#)
- [“Configuring the MVRP Applicant Mode” on page 13-9](#)
- [“Modifying MVRP Timers” on page 13-10](#)
- [“Restricting VLAN Registration” on page 13-11](#)
- [“Restricting Static VLAN Registration” on page 13-11](#)
- [“Restricting VLAN Advertisement” on page 13-12](#)

MVRP Specifications

IEEE Standards Supported	IEEE 802.1ak-2007 Amendment 7: Multiple Registration Protocol IEEE 802.1Q-2005 Corrigendum 2008
Platforms Supported	OmniSwitch 6860, 6860E
Maximum MVRP VLANs	4K

MVRP Defaults

The following table lists the defaults for MVRP configuration.

Parameter Description	Command	Default Value/Comments
Enables or disables MVRP globally on a switch.	mvrp	disabled
Enables or disables MVRP on specific ports	mvrp port	disabled
Maximum number of VLANs	mvrp maximum-vlan	256
Registration mode of the port	mvrp registration	normal
Applicant mode of the port	mvrp applicant	active
Timer value for join timer.	mvrp timer join	600 milliseconds
Timer value for leave timer.	mvrp timer leave	1800 milliseconds
Timer value for leaveall timer.	mvrp timer leaveall	30000 milliseconds
Timer value for periodic timer.	mvrp timer periodic-timer	1 second
Restrict dynamic VLAN registration	mvrp restrict-vlan-registration	not restricted
Restrict VLAN advertisement	mvrp restrict-vlan-advertisement	not restricted
Restrict static VLAN registration	mvrp static-vlan-restrict	By default, ports are assigned to the static VLAN based on MVRP PDU processing.

Quick Steps for Configuring MVRP

The following steps provide a quick tutorial on how to configure MVRP. Each step describes a specific operation and provides the CLI command syntax for performing that operation.

- 1 Create a VLAN using the **vlan** command. For example:

```
-> vlan 5 name "vlan-5"
```

- 2 Assign a port to the VLAN using the **vlan members** command. For example:

```
-> vlan 5 members port 1/1/2
```

- 3 Tag the port with one or more VLANs using the **vlan members** command. For example:

```
-> vlan 5 members port 1/1/2 tagged
```

- 4 Enable MVRP globally on the switch by using the **mvrp** command.

```
-> mvrp enable
```

- 5 Enable MVRP on the port by using the **mvrp port** command. For example, the following command enables MVRP on port 1/1/2 of the switch:

```
-> mvrp port 1/1/2 enable
```

- 6 *Optional:* Restrict a port from becoming a member of the statically created VLAN by using the **mvrp static-vlan-restrict** command. For example, the following command restricts port 1/1/5 from becoming a member of static VLAN 10:

```
-> mvrp port 1/1/5 static-vlan-restrict vlan 10
```

Note. To view the global configuration details of the router, enter the **show mvrp configuration** command. The globally configured details are displayed as shown:

```
-> show mvrp configuration
```

```
MVRP Enabled : yes,  
Maximum VLAN Limit : 256
```

To view the MVRP configuration for a specific port, enter the **show mvrp port** command. The configuration data of the particular port is displayed as shown:

```
-> show mvrp port 1/1/2
```

```
MVRP Enabled           : no,  
Registrar Mode         : normal,  
Applicant Mode         : participant,  
Join Timer (msec)      : 600,  
Leave Timer (msec)      : 1800,  
LeaveAll Timer (msec)   : 30000,  
Periodic Timer (sec)   : 1,  
Periodic Tx Status     : disabled
```

See the *OmniSwitch CLI Reference Guide* for information about the fields in this display. for information about the fields in this display.

MRP Overview

Multiple Registration Protocol (MRP) was introduced as a replacement for GARP with the IEEE 802.1ak-2007 amendment. The Multiple VLAN Registration Protocol (MVRP) defines a MRP Application that provides the VLAN registration service.

MVRP provides a mechanism for dynamic maintenance of the contents of dynamic VLAN registration Entries for each VLAN, and for propagating the information they contain to other bridges. This information allows MVRP-aware devices to dynamically establish and update their knowledge of the set of VLANs that currently have active members, and through which ports those members can be reached. The main purpose of MVRP is to allow switches to automatically discover some of the VLAN information that would otherwise have to be manually configured.

MVRP Overview

MVRP acts as an MRP application, sending and receiving MVRP information encapsulated in an ethernet frame on a specific MAC address. MVRP allows both end stations and bridges in a bridged local area network to issue and revoke declarations relating to membership of VLANs. Each MVRP device that receives the declaration in the network creates or updates a dynamic VLAN registration entry in the filtering database to indicate that the VLAN is registered on the reception port.

In this way, MVRP provides a method to share VLAN information within a layer 2 network dynamically, and configure the required VLANs. For example, in order to add a switch port to a VLAN, only the end port, or the VLAN-supporting network device connected to the switch port, must be reconfigured, and all necessary VLAN trunks are dynamically created on the other MVRP-enabled switches. Without using MVRP, either a manual configuration of VLAN trunks or use of a manufacturer specific proprietary method is necessary. MVRP helps to maintain VLAN configuration dynamically based on current network configurations.

How MVRP Works

An MVRP enabled port sends MRPDUs advertising the VLAN enabling another MVRP aware port receiving advertisements over a link to join the advertised VLAN dynamically. All ports of a dynamic VLAN operate as tagged ports for that VLAN.

An MVRP enabled port can forward an advertisement for a VLAN it learned about from other ports on the same switch. However, the forwarding port does not join that VLAN on its own until an advertisement for that VLAN is received on that same port.

The following example illustrates the VLAN advertisements.

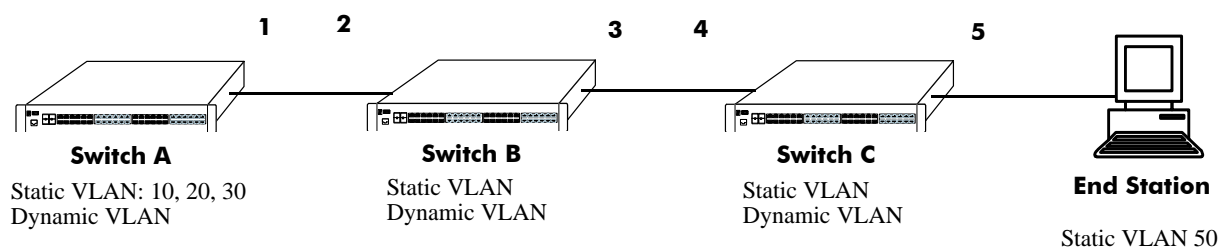

Initial Configuration of MVRP

Switch A has 3 VLANs configured as static VLANs (10, 20, and 30). Other switches on the same network learn these 3 VLANs as dynamic VLANs. Also, the end station connected on port 5 is statically configured for VLAN 50. Port 1 on Switch A is manually configured for VLANs 10, 20, and 30. All the ports are in the same Spanning tree instance and are in forwarding state. Hence, as the [Initial Configuration of MVRP](#) diagram shows,

- 1** Port 1 on Switch A advertises VLAN IDs (VIDs) 10, 20, and 30.
- 2** Port 2 on Switch B receives the advertisements. VLANs 10, 20, and 30 are created as VLANs on this Switch B and Port 2 become a member of VLANs 10, 20, and 30.
- 3** Port 3 on Switch B is triggered to advertise VLANs 10, 20, and 30, but does not become a member of these VLANs.
- 4** Port 4 on Switch C receives the advertisements. VLANs 10, 20, and 30 are created as VLANs on Switch C and Port 4 become a member of VLANs 10, 20, and 30.
- 5** Port 5 advertises VLANs 10, 20, and 30, but this port is not a member of these VLANs.

Note. Default VLAN (VLAN 1) exists on all switches, but it is not considered here.

The configuration sequence of advertisements and registration of VLANs results in the following configuration.

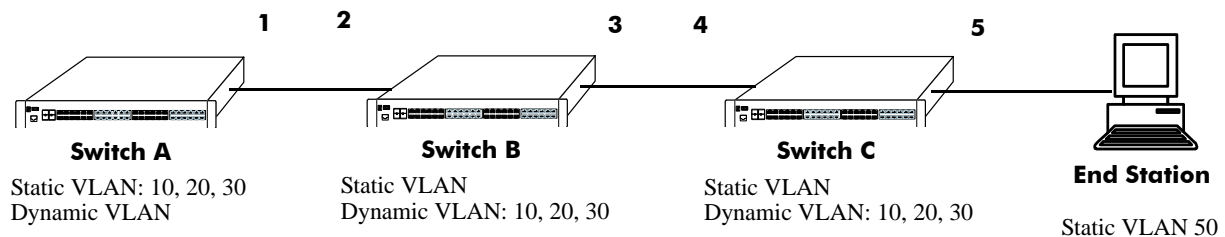

Dynamic Learning of VLANs 10, 20, and 30

Here, the end station advertises itself as a member of VLAN 50. As the [Dynamic Learning of VLANs 10, 20, and 30](#) diagram shows,

- 1** Port 5 receives the advertisement and Switch C creates VLAN 50 as a dynamic VLAN. Port 5 of Switch C becomes a member of VLAN 50.
- 2** Port 4 advertises VLAN 50, but is not a member of VLAN 50.
- 3** Port 3 of Switch B receives the advertisement, Switch B creates the dynamic VLAN 50, and Port 3 becomes a member of VLAN 50.
- 4** Port 2 advertises VLAN 50, but is not a member of this VLAN.
- 5** Port 1 on Switch A receives the advertisement, creates dynamic VLAN 50. Port 1 becomes a member of VLAN 50.

The resulting configuration is depicted as follows:

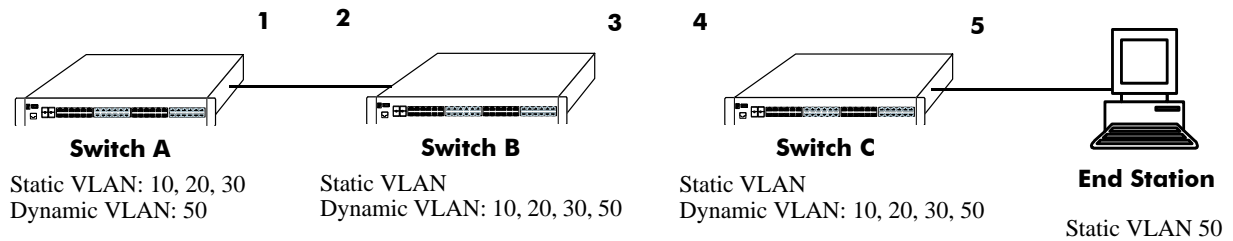

Dynamic Learning of VLAN 50

Note. Every port on a switch is not a member of all the VLANs. Only those ports that receive the advertisement become members of the VLAN being advertised.

Interaction With Other Features

This section contains important information about how other OmniSwitch features interact with MVRP. Refer to the specific chapter for each feature to get more detailed information about how to configure and use the feature.

STP

The MVRP feature is supported only in STP flat mode. If MVRP is configured in the system with STP flat mode, then STP mode cannot be changed to per-VLAN mode. When a topology change is detected by STP, MAC addresses for the dynamic VPAs learned by MVRP is also deleted.

Configuring MVRP

This section describes how to configure MVRP using the Command Line Interface (CLI) commands.

Enabling MVRP

MVRP is used primarily to prune unnecessary broadcast and unknown unicast traffic, and to create and manage VLANs. MVRP has to be globally enabled on a switch before it can start forwarding MVRP frames. When a port is enabled for MVRP, it cannot be converted as an aggregate or a VLAN stacking User port.

To enable MVRP globally on the switch, enter the **mvrp** command at the CLI prompt as shown:

```
-> mvrp enable
```

To disable MVRP globally on the switch, use disable option of the **mvrp** command as shown:

```
-> mvrp disable
```

Note. Disabling MVRP globally leads to the deletion of all learned VLANs.

MVRP can be enabled on ports regardless of whether it is globally enabled or not. However, for the port to become an active participant, MVRP must be globally enabled on the switch. By default, MVRP is disabled on the ports. To enable MVRP on a specified port, use the **mvrp port** command.

For example:

```
-> mvrp port 1/1/2 enable
```

Similarly, to enable MVRP on aggregate group 10, enter:

```
-> mvrp linkagg 10 enable
```

To disable MVRP on a specific port, use disable option of the **mvrp port** command as shown:

```
-> mvrp port 1/1/2 enable
```

Note. MVRP can be configured only on fixed, 802.1 Q and aggregate ports. It cannot be configured on aggregate and VLAN Stacking User ports.

Configuring the Maximum Number of VLANs

A switch can create dynamic VLANs using MVRP. If the VLAN limit to be set is less than the current number of dynamically learned VLANs, then the new configuration takes effect only after the MVRP is disabled and enabled again on the switch. If this operation is not done, the VLANs learned earlier are maintained.

To modify the maximum number of dynamic VLANs the switch is allowed to create, use the **mvrp maximum-vlan** command as shown:

```
-> mvrp maximum-vlan 150
```

Configuring MVRP Registration

MVRP allows a port to register and de-register static VLANs. Every device has a list of all the switches and end stations that can be reached at any given time. When an attribute for a device is registered or de-registered, the set of reachable switches and end stations, also called participants, is modified. Data frames are propagated only to registered devices, thereby preventing attempts to send data to devices that are not reachable.

The following sections describe MVRP registration on switches:

Setting MVRP Normal Registration

The normal registration mode allows dynamic creation, registration, and de-registration of VLANs on a device. The normal mode is the default registration mode.

To configure a port in normal mode, use the **mvrp registration** command. For example, to configure port 2 of slot 1 in normal mode, enter the following:

```
-> mvrp port 1/1/2 registration normal
```

To view the registration mode of the port, use the **show mvrp port** command. For example:

```
-> show mvrp port 1/1/2

MVRP Enabled           : no,
Registrar Mode         : normal,
Applicant Mode         : participant,
Join Timer (msec)      : 600,
Leave Timer (msec)      : 1800,

LeaveAll Timer (msec)   : 30000,
Periodic Timer (sec)   : 1,
Periodic Tx status     : disabled
```

Setting MVRP Fixed Registration

The fixed registration mode allows only manual registration of the VLANs and prevents dynamic or static de-registration of VLANs on the port.

To configure a port to fixed mode, use the **mvrp registration** command. For example, to configure port 2 of slot 1 to fixed mode, enter the following:

```
-> mvrp port 1/1/2 registration fixed
```

To view the registration mode of the port, use the **show mvrp port** command. For example,

```
-> show mvrp port 1/1/2

MVRP Enabled           : no,
Registrar Mode         : fixed,
Applicant Mode         : participant,
Join Timer (msec)      : 600,
Leave Timer (msec)      : 1800,
LeaveAll Timer (msec)   : 30000,
Periodic Timer (sec)   : 1,
Periodic Tx status     : disabled
```

Note. The registration mode for the default VLANs of all the ports in the switch is set to normal.

Setting MVRP Forbidden Registration

The forbidden registration mode prevents any VLAN registration or de-registration. If dynamic VLANs previously created are present, they are de-registered.

To configure a port to forbidden mode, use the **mvrp registration** command. For example, to configure port 2 of slot 1 to forbidden mode, enter the following:

```
-> mvrp port 1/1/2 registration forbidden
```

To view the registration mode of the port, use the **show mvrp port** command. For example,

```
-> show mvrp port 1/1/2

MVRP Enabled           : no,
Registrar Mode         : forbidden,
Applicant Mode         : participant,
Join Timer (msec)      : 600,
Leave Timer (msec)     : 1800,
LeaveAll Timer (msec)  : 30000,
Periodic Timer (sec)   : 1,
Periodic Tx status    : disabled
```

To view the MVRP configurations for all the ports, including timer values, registration and applicant modes, enter the following:

```
-> show mvrp port enable
```

Port	Join Timer (msec)	Leave Timer (msec)	LeaveAll Timer (msec)	Periodic Timer (sec)	Registration Mode	Applicant Mode	Periodic TxStatus
1/1/1	600	1800	30000	2	fixed	active	enabled
1/1/2	600	1800	30000	2	fixed	active	enabled
1/1/7	600	1800	30000	2	fixed	active	enabled
1/1/8	600	1800	30000	2	fixed	active	enabled
1/2/24	600	1800	30000	2	fixed	active	enabled

Configuring the MVRP Applicant Mode

The MVRP applicant mode determines whether MVRP PDU exchanges are allowed on a port, depending on the Spanning Tree state of the port. This mode can be configured to be **participant**, **non-participant**, or **active**. By default, the port is in the **active** mode.

To prevent undesirable Spanning Tree Protocol topology reconfiguration on a port, configure the MVRP applicant mode as active. Ports in the MVRP active applicant state send MVRP VLAN declarations even when they are in the STP blocking state, thereby preventing the STP bridge protocol data units (BPDUs) from being pruned from the other ports.

Use the **mvrp applicant** command to set the applicant mode of a port to active. For example, to set the applicant mode of port 1/1/2 to active, enter the following:

```
-> mvrp port 1/1/2 applicant active
```

When a port is set to participant mode, MVRP protocol exchanges are allowed only if the port is set to the STP forwarding state.

To set the applicant mode of port 1/1/2 to participant mode, enter the following:

```
-> mvrp port 1/1/2 applicant participant
```

When a port is set to non-participant mode, MVRP PDUs are not sent through the STP forwarding and blocking ports.

To set the applicant mode of port 1/1/2 to non-participant mode, enter the following:

```
-> mvrp port 1/1/2 applicant non-participant
```

The applicant mode of the port can be set to the default value by using the **mvrp applicant** command. To set the MVRP applicant mode of port 1/1/2 to the default mode (active mode), enter the following command:

```
-> mvrp port 1/1/2 applicant active
```

Modifying MVRP Timers

MVRP timers control the timing of dynamic VLAN membership updates to connected devices. The following are the various timers in MVRP:

- **Join timer**—The maximum time an MVRP instance waits before making declaration for VLANs.
- **Leave timer**—The wait time taken to remove the port from the VLAN after receiving a Leave message on that port.
- **LeaveAll timer**—The time an MVRP instance takes to generate LeaveAll messages. The LeaveAll message instructs the port to modify the MVRP state of all its VLANs to **Leave**.
- **Periodic timer**—The time frequency with which the messages are transmitted again and again.

When you set the timer values, the value for the Leave timer must be greater than or equal to twice the Join timer value plus 100 milliseconds. (**Leave** >= **Join** * 2 + 100). The LeaveAll timer value must be greater than or equal to the Leave timer value (**LeaveAll** >= **Leave**). If you attempt to set a timer value that does not adhere to these rules, an error message is displayed.

For example, if you set the Leave timer to 1200 ms and attempt to configure the Join timer to 600 ms, an error is returned. Set the Leave timer to at least 1300 ms and then set the Join timer to 600 ms.

To modify the Join timer value, use the **mvrp timer join** command. For example, to modify the Join timer value of port 1/1/2, enter the following:

```
-> mvrp port 1/1/2 timer join 600
```

The Join timer value of port 1/1/2 is now set to 600 ms.

To set the Leave timer value of port 1/1/2 to 1800 ms, enter the command as shown:

```
-> mvrp port 1/1/2 timer leave 1800
```

To set the LeaveAll timer of port 1/1/2 to 30000 ms, enter the command as shown:

```
-> mvrp port 1/1/2 timer leaveall 30000
```

To set the Periodic timer of port 1/1/2 to 1 second, enter the command as shown:

```
-> mvrp port 1/1/2 timer periodic-timer 1
```

To view the timer value assigned to a particular port, use the **show mvrp timer** command.

```
-> show mvrp port 1/1/2 timer
Join Timer (msec) : 600,
Leave Timer (msec) : 1800,
LeaveAll Timer (msec) : 30000,
Periodic-Timer (sec) : 1
```

Note. Set the same MVRP timer value on all the connected devices.

Restricting VLAN Registration

Restricted VLAN registration restricts MVRP from dynamically registering specific VLAN or VLANs on a switch. It decides whether VLANs can be dynamically created on a device or only be mapped to the ports (if the VLANs are already statically created on the device).

By default, the dynamic VLAN registrations are not restricted and the VLAN can either be created on the device or mapped to another port.

To restrict a VLAN from being dynamically learned on the device, you can configure the dynamic VLAN registrations by using the **mvrp restrict-vlan-registration** command as shown:

```
-> mvrp port 1/1/1 restrict-vlan-registration vlan 4
```

Here, VLAN 4 cannot be learned by the device dynamically. However, if the VLAN exists on the device as a static VLAN, it can be mapped to the receiving port.

To allow dynamic VLAN registrations on the port, use the no form of the **mvrp restrict-vlan-registration** command as shown:

```
-> no mvrp port 1/1/1 restrict-vlan-registration vlan 4
```

Restricting Static VLAN Registration

Ports can be exempted from becoming members of statically created VLANs. To restrict a port from becoming a member of a statically configured VLAN, use the **mvrp static-vlan-restrict** command as shown:

```
-> mvrp port 1/1/9 static-vlan-restrict vlan 5
```

Note. This command does not apply to dynamic VLANs.

Here, the port 1/1/9 is restricted from becoming a MVRP member of VLAN 5.

To restrict a port from becoming a member of a range of statically created VLANs, enter the **mvrp static-vlan-restrict** command as shown:

```
-> mvrp port 1/1/9 static-vlan-restrict vlan 5-9
```

Here, port 1/9 is restricted from becoming a MVRP member of VLANs 5 to 9.

A port can be allowed to become a member of statically created VLANs using the no form of the **mvrp static-vlan-restrict** command. To allow port 1/1/2 to become a member of a statically created VLAN, enter the command as shown:

```
-> no mvrp port 1/1/2 static-vlan-restrict vlan 5-9
```

Restricting VLAN Advertisement

VLANs learned by a switch through MVRP can either be propagated to other switches or be blocked. This helps prune VLANs that have no members on a switch. If the applicant mode is set to participant or active, you can use the **mvrp restrict-vlan-advertisement** command to restrict the propagation of VLAN information on a specified port as shown:

```
-> mvrp port 1/1/1 restrict-vlan-advertisement vlan 5
```

Here, VLAN 5 is not allowed to propagate on port 1/1/1.

To enable the propagation of dynamic VLANs on the specified port, use the no form of the command. To restrict VLAN 5 from being propagated to port 1/1/1, enter the command as shown:

```
-> no mvrp port 1/1/1 restrict-vlan-advertisement vlan 5
```

Verifying the MVRP Configuration

A summary of the commands used for verifying the MVRP configuration is given here:

show mvrp last-pdu-origin	Displays the source MAC address of the last MVRP message received on specific ports or aggregates.
show mvrp configuration	Displays the global configuration for MVRP.
show mvrp linkagg	Displays the MVRP configuration for a specific port or an aggregate of ports.
show mvrp port	Displays the MVRP configurations for all the ports, including timer values, registration and applicant modes.
show mvrp vlan-restrictions	Displays the list of VLANS learned through MVRP and their details.
show mvrp timer	Displays the timer values configured for all the ports or a specific port.
show mvrp statistics	Displays the MVRP statistics for all the ports, aggregates, or specific ports.
clear mvrp statistics	Clears MVRP statistics for all the ports, an aggregate of ports, or a specific port.

For more information about the output details that result from these commands, see the *OmniSwitch AOS Release 8 CLI Reference Guide*.

14 Configuring 802.1AB

Link Layer Discovery Protocol (LLDP) and LLDPv2 is a standard that provides a solution for the configuration issues caused by expanding networks. LLDP supports the network management software used for complete network management. LLDP is implemented as per the IEEE 802.1AB standard. LLDP specifically defines a standard method for Ethernet network devices and Media Endpoint Devices (MED) to exchange information with its neighboring devices and maintain a database of the information. The exchanged information, passed as LLDPDU, is in TLV (Type, Length, Value) format. The information available to the network management software must be as new as possible; hence, remote device information is periodically updated.

In This Chapter

This chapter describes the basic components of 802.1AB and how to configure them through the Command Line Interface (CLI). The CLI commands are used in the configuration examples; for more details about the syntax of commands, see [Chapter 14, “802.1AB Commands,”](#) in the *OmniSwitch AOS Release 8 CLI Reference Guide*.

Configuration procedures described in this chapter include the following:

- [“Quick Steps for Configuring 802.1AB”](#) on page 14-4
- [“Configuring LLDPDU Flow”](#) on page 14-11.
- [“Enabling and Disabling Notification”](#) on page 14-11.
- [“Enabling and Disabling Management TLV”](#) on page 14-12.
- [“Nearest Bridge/Edge Mode”](#) on page 14-9
- [“Enabling and Disabling 802.1 TLV”](#) on page 14-13.
- [“Enabling and Disabling 802.3 TLV”](#) on page 14-13.
- [“Enabling and Disabling MED TLV”](#) on page 14-14.
- [“Enabling and Disabling Application Priority TLV”](#) on page 14-14.
- [“Setting the Transmit Hold Multiplier Value”](#) on page 14-15.
- [“Setting the Reinit Delay”](#) on page 14-15.
- [“Setting the Notification Interval”](#) on page 14-15.
- [“Verifying 802.1AB Configuration”](#) on page 14-16.

802.1AB Specifications

Platforms Supported	OmniSwitch 6860, 6860E
IEEE Specification	IEEE 802.1AB-2009 Station and Media Access Control Connectivity Discovery
Maximum number of network policies that can be associated with a port	8
Maximum number of network policies that can be configured on the switch	32
Nearest Edge MAC Address	01:20:da:02:01:73
Nearest Bridge MAC Address	01:80:c2:00:00:0e
Nearest Customer MAC Address	01:80:C2:00:00:00
Non-TPMR Address	01:80:C2:00:00:03

802.1AB Defaults Table

The following table shows the default settings of the configurable 802.1AB parameters.

Parameter Description	Command	Default Value/Comments
Transmit time interval for LLDPDU's	lldp nearest-edge mode	30 seconds
Transmit hold multiplier value	lldp transmit hold-multiplier	4
Reinit delay	lldp reinit delay	2 seconds
Notification interval	lldp notification interval	5 seconds
LLDPDU's transmission	lldp lldpdu	Transmission and Reception
Per port notification	lldp notification	Disable
Management TLV	lldp tlv management	Disable
802.1 TLV	lldp tlv dot1	Disable
802.3 TLV	lldp tlv dot3	Disable
LLDP Media Endpoint Device	lldp tlv med	Disable

Quick Steps for Configuring 802.1AB

- 1 To enable the transmission and the reception of LLDPDU on a port, use the **lldp lldpdu** command. For example:

```
-> lldp port 1/1/47 lldpdu tx-and-rx
```
- 2 To control per port notification status about a change in a remote device associated to a port, use the **lldp notification** command. For example:

```
-> lldp port 1/1/47 notification enable
```
- 3 To control per port management TLV to be incorporated in the LLDPDUs, use the **lldp tlv management** command. For example:

```
-> lldp port 1/1/47 tlv management port-description enable
```
- 4 Set the transmit time interval for LLDPDUs. To set the timer for a 50 second delay, use the **lldp nearest-edge mode** command. For example:

```
-> lldp transmit interval 50
```
- 5 Set the LLDPDUs transmit fast start count required for LLDP Fast Restart mechanism to be activated.

Note. *Optional.* Verify the LLDP per port statistics by entering the **show lldp statistics** command. For example:

```
-> show lldp statistics
```

Chas/ Slot/Port	LLDPDU Tx	LLDPDU TxLenErr	LLDPDU Rx	LLDPDU Errors	LLDPDU Discards	TLV Unknown	TLV Discards	Device Ageouts
1/1/1	453	0	452	0	0	0	0	0
1/1/2	452	0	453	0	0	0	0	0
1/1/5	452	0	473	0	0	476	476	0
1/1/8	455	0	464	0	0	0	0	0
1/1/9	456	0	464	0	0	0	0	0

To verify the remote system information, use the **show lldp remote-system** command. For example:

```
-> show lldp remote-system
Remote LLDP Agents on Local Slot/Port: 1/1/47,
  Chassis ID Subtype      = 4 (MAC Address),
  Chassis ID              = 00:d0:95:e9:c9:2e,
  Port ID Subtype        = 7 (Locally assigned),
  Port ID                 = 2048,
  Port Description        = (null),
  System Name             = (null),
  System Description      = (null),
  Capabilities Supported  = none supported,
  Capabilities Enabled    = none enabled,
```

For more information about this display, see the *OmniSwitch CLI Reference Guide*.

802.1AB Overview

LLDP is a Layer 2 protocol used to detect adjacent devices in a network. Each device in a network sends and receives LLDPDU through all ports on which the protocol is enabled. If the protocol is disabled on a port, then LLDPDU received on that port are dropped.

The LLDPDU are transmitted at a certain interval. This transmission interval can be configured. When an LLDPDU is received from a neighboring device, the LLDPDU software validates the frame and stores the information in the remote device Management Information Base (MIB). This information ages periodically. If an LLDPDU is not received from the same device within the time specified in the TTL TLV of the LLDPDU, the information is updated in the related MIB.

By exchanging information with all the neighbors, each device gets to know its neighbor on each port. The information contained in the LLDPDU is transmitted in the TLV (Type, Length, Value) format and falls under two categories:

- Mandatory
- Optional

Each LLDPDU contains all the five mandatory TLVs and optional TLVs.

There are many other LLDP features supported on OmniSwitch AOS as follows:

- Multiple LLDP agents (Nearest-Bridge, Nearest-Customer, Non-TPMR)
- TLV selection per agent per port
- Statistics per agent per port
- LLDP administrator control per agent per port
- Remote MIB change notification per agent per port
- Remote system information per agent per port
- Transmit credit for LLDPDU transmission
- Fast transmission of LLDPDU during neighbor detection
- Selection of time interval between transmissions during fast transmission period

Mandatory TLVs

The mandatory TLV information contains the following information with regard to the LAN device:

- MSAP (MAC service access point) identifier.
- Time period for the validity of the information

The mandatory TLVs contained in an LLDPDU are listed below:

- Chassis ID TLV
- Port ID TLV
- VLAN ID TLV
- Time to live TLV
- End of LLDPDU TLV

Optional TLVs

The optional TLVs defined as part of LLDP are grouped into the following sets listed below:

Basic Management TLV Set

- Port Description TLV
- System Name TLV
- System Description TLV
- System capabilities TLV
- Management address TLV

Note. This optional TLV set is required for all LLDP implementation.

IEEE 802.1 Organizationally Specific TLV Set

- Port VLAN ID TLV
- Port and Protocol VLAN ID TLV
- VLAN name TLV
- Protocol identity TLV
- Congestion Notification TLV
- Application Priority TLV

Note. If one TLV from this set is included in the LLDPDU, then all the other TLVs need to be included.

IEEE 802.3 Organizationally Specific TLV Set

- MAC/PHY configuration/status TLV
- Power through MDI TLV (in network connectivity TLV set, Extended Power-through-MDI TLV is supported)
- Link Aggregation TLV
- Maximum frame size TLV

ANSI-TIA LLDP-MED TLV Sets

- Network connectivity TLV set
- LLDP-MED capabilities TLV
- Inventory Management TLV
- Location Identification TLV
- Extended Power-via-MDI TLV

When an 802.1AB supporting system receives an LLDPDU containing MED capability TLV, then the remote device is identified as an edge device, for example, IP phone and IP PBX, among others. In such a case, the switch stops sending LLDPDU and starts sending MED LLDPDU on the port connected to the edge device.

LLDP PoE Power Negotiation

The IEEE 802.3 specific TLVs for mac-phy or power-via-mdi can be used for PoE power negotiation.

mac-phy TLV

When mac-phy is configured the power class detection is done via hardware by the switch's PoE controller and the maximum power for the port is based on the class of the powered device. Powered devices can draw up to the maximum amount of power allowed for its class without any negotiation with the switch.

power-via-mdi TLV

When power-via-mdi is configured the power for the powered device is negotiated using the optional power via MDI TLV in the LLDPDU. The powered device can request additional power using the power via MDI TLV. The switch will check the current PoE budget and if power is available the switch will provide the requested power to the powered device. If power is unavailable, the switch will respond with the existing maximum power information.

- Power negotiation is supported for Class 4 powered devices.
- The maximum power a powered device can request cannot exceed the maximum power allowed for the PoE class in which the powered device is detected.
- If the port is manually configured with a maximum power value, the powered device cannot receive more power than the maximum configured value.

For an example on how to configure LLDP PoE Negotiation, see [“Enabling and Disabling 802.3 TLV” on page 14-13](#).

LLDP-Media Endpoint Devices

LLDP-MED is an extension to 802.1ab (Link Layer Discovery Protocol - LLDP), a link-layer protocol that defines a method for network access devices using Ethernet connectivity to advertise device information, device capabilities and media specific configuration information periodically to peer devices attached to the same network.

The LLDP-MED feature facilitates the information sharing between Media Endpoint Devices and Network Infrastructure Devices. It is designed to allow the following functionalities:

- Auto-discovery of LAN policies (such as VLAN, Layer 2 Priority and Diffserv settings) leading to "plug and play" networking. This is achieved by advertising the VLAN information.
- Device location discovery to allow creation of location databases for VoIP, E911 services.
- Extended and automated power management of Power-over-Ethernet endpoints.
- Inventory management, allowing network administrators to track their network devices, and determine their characteristics (manufacturer, software and hardware versions, and serial / asset number).
- Support for receiving, storing and advertising of VLAN information from and to remote Network Connectivity Devices and Media Endpoint Devices (MEDs).
- Support for receiving and storing of Inventory Management TLVs from remote Media Endpoint Devices.

Automatic VLAN Assignment for IP Phone through LLDP MED

Automatic VLAN Assignment (AVA) is used for assigning VLANs specifically to IP phones that are Endpoint devices. AVA implementation is often complicated as it requires two DHCP servers, one for VLAN assignment and one for IP address assignment. LLDP MED Network Policy allows the switch to advertise the VLAN to the connected IP Phones.

The assignment of the VLAN to IP Phones is done explicitly through definition of LLDP MED Network Policy Identifier. VLAN assignment through explicit LLDP MED Network Policy is supported on the OmniSwitch.

For LLDP to work on fixed the VLAN and VPA must be created. However, if the VLAN is not created and the VLAN is added in the LLDP MED Network Policy, no error is thrown to the user.

For the feature to work on fixed ports, VPA association must be there between the port and the advertised VLAN.

Since MED TLVs are encapsulated in LLDPDU, on detection of MED Capable endpoint device, the LLDPDU is transmitted.

To assign an LLDP network policy on switch ports, first create the VLAN, and associate a port to it. Then create the network policy and bind it to a port.

```
-> vlan 10
-> vlan 10 members port 1/1/10 tagged
-> lldp port 1/1/10 tlv med network-policy enable
-> lldp network-policy 1 application voice vlan 10 l2-priority 5
-> lldp port 1/1/10 med network-policy 1
```

Multiple LLDP Agent Support

OmniSwitch AOS supports 802.1ab 2009 standard with LLDP V2 support where each port can run multiple LLDP agents sending and receiving LLDPDUs using different destination MAC addresses. A maximum of three LLDP agents are supported per port.

The following table illustrates the different LLDP agent configuration options available and the related IEEE standard 802.1D reserved addresses, the CVLAN reserved addresses and the SVLAN reserved addresses:

Name	Address	Purpose
Nearest Bridge	01:80:C2:00:00:0E	LLDPDU propagation constrained to a single physical link and stopped by all other bridges.
Nearest non-TPMR bridge	01:80:C2:00:00:03	Propagation constrained by all bridges other than TPMRs. Intended for use within provider bridged networks.
Nearest Customer bridge	01:80:C2:00:00:00	Propagation constrained by customer bridges. This provides the same coverage as a customer to customer MAC secure connection.

All	01:80:C2:00:00:0E 01:80:C2:00:00:03 01:80:C2:00:00:00	Configures all three LLDP agents on the specified port, slot or chassis.
-----	---	--

LLDP Agent Operation

A network device that implements LLDP, supports multiple LLDP agents. The LLDP agent operates in any one of the following three modes:

Transmit-only mode: The agent can only transmit the information about the capabilities and the current status of the local system at regular intervals.

Receive-only mode: The agent can only receive information about the capabilities and the current status of the remote systems.

Transmit and receive mode: The agent can transmit the capabilities and status information of the local system and receive the capabilities and the status information of the remote system.

LLDPDU Transmission and Reception

LLDP operates in a one-way direction, so that the information in the LLDPDUs flows from one device to another. LLDPDUs are not exchanged as an information request by one device and a response sent by another device. The other devices do not acknowledge LLDP information received from a device.

The transmission of LLDPDU is based on two factors:

- Transmit countdown timing counter. For example, whenever the counter expires, it goes through the entire database of ports that have links and sends the LLDPDU when the current time has exceeded the re-transmission time interval.
- If there is change in status of any of the ports. For example, a new port is attached or a new link has come up.

Reception of LLDPDU is a two-phase process:

- LLDPDU and TLV error handling as per the 802.1AB standard
- LLDP remote system MIB update

Aging Time

The LLDP specific information of the remote system is stored in the LLDP MIB. The TTL TLV carries a positive value in seconds, and conveys to the other device the duration for which this information is valid. Once a remote device is learned on a local port, if the receiving device does not receive an LLDPDU from the same remote device and on the same local port within the TTL mentioned in the previous LLDPDU, then the local device discards the related entry from its database. This is called the aging time and can be set by the user.

Nearest Bridge/Edge Mode

Nearest Edge Mode is designed to be used in conjunction with the Automatic Remote Configuration Download feature. By default, when deploying a new switch that does not have any configuration, the Automatic Remote Configuration feature automatically creates a DHCP interface only on the default VLAN. The Nearest Edge mode enhances this functionality and allows the new switch to learn the ID of a

management VLAN being advertised by its neighbor and enables the DHCP client interface on a tagged interface for that VLAN.

See the “Managing Automatic Remote Configuration Download” chapter in the *OmniSwitch AOS Release 8 Switch Management Guide* for additional information on the Automatic Remote Configuration feature.

The OmniSwitch supports the following two modes:

Nearest-Bridge Mode:

- Nearest-bridge Mode is the default mode for LLDP.
- Nearest-bridge Mode uses the LLDP standard "nearest-bridge" address of 01:80:c2:00:00:0e as the destination MAC address.
- When running in Nearest-bridge Mode LLDP frames with the nearest-edge MAC address are not processed by LLDP but are flooded as normal L2 multicast frames.

Nearest-Edge Mode:

- The switch must be configured to operate in Nearest-edge mode.
- Nearest-edge Mode uses the Nearest-edge MAC address of 01:20:da:02:01:73 as the destination MAC address, this MAC address is not configurable.
- When LLDP is set to Nearest-edge Mode LLDP frames with a destination MAC address of 01:20:da:02:01:73 are processed by LLDP.
- When running in Nearest-edge Mode LLDP frames with the nearest-bridge MAC address are not processed by LLDP but are flooded as normal L2 multicast frames.

Nearest-Edge Mode Operation

In order for the network to propagate Nearest-edge Mode LLDP PDUs, a Management Switch must be configured to send the LLDP PDUs with the management VLAN information. Additionally, the Access Switch is automatically configured to process the Nearest-edge Mode LLDP PDU frames by the Automatic Configuration Download feature.

LLDP Transmission by the Management Switch

- The Management Switch is configured to use the Nearest-edge MAC address through the **lldp nearest-edge mode** command and is connected to the network using an untagged interface.
- LLDP is configured on the untagged port of the Management Switch so that the LLDP PDUs are sent with the management VLAN information.
- The Management Switch sends LLDPDUs on the untagged interface with the 01:20: DA:02:01:73 MAC address.
- The OmniSwitch Automatic Remote Configuration feature requires learning the Management VLAN ID from a centralized management switch. This VLAN ID information is distributed through the LLDP message.
- This functionality also depends on the nearest bridge agent LLDPDU transmit mode. LLDP sends a Port VLAN ID TLV when both of the below commands are executed:

```
-> lldp nearest-bridge chassis lldpdu tx-and-rx
-> lldp nearest-edge mode enable
```

Configuring 802.1AB

The following sections list detail procedures to enable 802.1AB and assign ports to 802.1AB.

Configuring LLDPDU Flow

The **lldp lldpdu** command can be used to enable or disable the LLDPDU flow on a specific port, a slot, or all ports on a switch. When enabled, the port can be set to receive, transmit, or to transmit and receive LLDPDUs.

To set the LLDPDU flow on a switch as transmit and receive, enter the **lldp lldpdu** command:

```
-> lldp chassis lldpdu tx-and-rx
```

To set the LLDPDU flow on port 1/1/4 as receive, enter the following command at the CLI prompt:

```
-> lldp port 1/1/4 lldpdu rx
```

To disable the flow of LLDPDU on a switch, enter the **lldp lldpdu** command:

```
-> lldp chassis lldpdu disable
```

To disable the flow of LLDPDU on port 5 of slot 1, enter the following command at the CLI prompt:

```
-> lldp port 1/1/5 lldpdu disable
```

To set the LLDPDU flow for nearest-bridge agent on a switch as transmit and receive, enter the **lldp lldpdu** command:

```
-> lldp nearest-bridge chassis lldpdu tx-and-rx
```

To set the LLDPDU flow on port 1/1/4 for non-tpmr agent as receive, enter the following command at the CLI prompt:

```
-> lldp non-tpmr port 1/1/4 lldpdu rx
```

To enable the flow of LLDPDU on a switch for nearest-edge, enter the **lldp lldpdu** command:

```
-> lldp nearest-edge chassis lldpdu enable
```

To disable the flow of LLDPDU on port 5 of slot 1, enter the following command at the CLI prompt:

```
-> lldp all port 1/1/5 lldpdu disable
```

Enabling and Disabling Notification

The **lldp notification** command is used to control per port notification status about the remote device change on a specific port, a slot, or all ports on a switch. When enabled, the LLDPDU administrative status must be in the receive state.

To enable notification of local system MIB changes on a switch, enter the **lldp notification** command:

```
-> lldp chassis notification enable
```

To enable notification on port 1/1/2, enter the following command at the CLI prompt:

```
-> lldp port 1/1/2 notification enable
```

To disable notification on port 1/1/4, enter the following command at the CLI prompt:

```
-> lldp port 1/1/4 notification disable
```

Configuring an LLDP Network Policy

To configure an LLDP network policy, use the **lldp network-policy** command. For example:

```
-> lldp network-policy 1 application voice vlan priority-tag dscp 39
```

Enabling and Disabling Management TLV

The **lldp tlv management** command is used to control per port management TLVs transmission in the LLDPDUs on a specific port, a slot, or all ports on a switch. When enabled, the LLDPDU administrative status must be in the transmit state.

To enable the management TLV LLDPDU transmission on a switch, enter the **lldp tlv management** command:

```
-> lldp chassis tlv management port-description enable
```

To enable the management TLV on port 1/1/3, enter the following command at the CLI prompt:

```
-> lldp port 1/1/3 tlv management system-capabilities enable
```

To disable the management TLV on a switch, enter the **lldp tlv management** command:

```
-> lldp chassis tlv management port-description disable
```

To disable management TLV on port 1/1/3, enter the following command at the CLI prompt:

```
-> lldp port 1/1/3 tlv management system-capabilities disable
```

To enable the management TLV LLDPDU transmission for non TPMR switch agent, enter the **lldp tlv management** command:

```
-> lldp non-tpmr chassis tlv management port-description enable
```

To enable the management TLV for all agents on port 1/1/3, enter the following command at the CLI prompt:

```
-> lldp all port 1/1/3 tlv management system-capabilities enable
```

Enabling and Disabling 802.1 TLV

The **lldp tlv dot1** command is used to control per port 802.1 TLVs transmission in the LLDPDUs on a specific port, a slot, or all ports on a switch. When enabled, the LLDPDU administrative status must be in the transmit state.

To enable the 802.1 TLV LLDPDU transmission on a switch, enter the **lldp tlv dot1** command:

```
-> lldp chassis tlv dot1 port-vlan enable
```

To enable the 802.1 TLV on port 1/1/1, enter the following command at the CLI prompt:

```
-> lldp port 1/1/1 tlv dot1 vlan-name enable
```

To disable the 802.1 TLV on a switch, enter the **lldp tlv dot1** command:

```
-> lldp chassis tlv dot1 port-vlan disable
```

To disable 802.1 TLV on port 1/1/2, enter the following command at the CLI prompt:

```
-> lldp port 1/1/2 tlv dot1 vlan-name disable
```

To enable the 802.1 TLV for **nearest-bridge** agent on a switch, enter the **lldp tlv dot1** command:

```
-> lldp nearest-bridge slot 1/1 tlv dot1 vlan-name enable
```

To enable the 802.1 TLV for **non-TPMR** agent on a switch, enter the **lldp tlv dot1** command:

```
-> lldp non-tpmr slot 1/1 tlv dot1 port-vlan enable
```

Enabling and Disabling 802.3 TLV

The **lldp tlv dot3** command is used to control per port 802.3 TLVs transmission in the LLDPDUs on a specific port, a slot, or all ports on a switch. When enabled, the LLDPDU administrative status must be in the transmit state.

To enable the 802.3 TLV LLDPDU transmission on a switch, enter the **lldp tlv dot3** command, as shown:

```
-> lldp chassis tlv dot3 mac-phy enable
```

To enable the 802.3 TLV on port 1/1/4, enter the following command at the CLI prompt:

```
-> lldp port 1/1/4 tlv dot3 mac-phy enable
```

To disable the 802.3 TLV on a switch, enter the **lldp tlv dot3** command, as shown:

```
-> lldp chassis tlv dot3 mac-phy disable
```

To disable 802.3 TLV on port 1/1/5, enter the following command at the CLI prompt:

```
-> lldp port 1/1/5 tlv dot3 mac-phy disable
```

To enable the power-via-mdi 802.3 TLV for slot, enter the following at the CLI prompt:

```
-> lldp slot 1/1 tlv dot3 power-via-mdi enable
```

To enable the 802.1 TLV for **nearest-bridge** agent on a switch:

```
-> lldp nearest-bridge port 1/1/4 tlv dot3 mac-phy enable
```

Enabling and Disabling MED TLV

The **lldp tlv med** command is used to control per port LLDP Media End Device (MED) TLVs transmission in the LLDPDUs on a specific port, a slot, or all ports on a switch. When enabled, the LLDPDU administrative status must be in the transmit state.

To enable the LLDP-MED TLV LLDPDU transmission on a switch, enter the **lldp tlv med** command, as shown:

```
-> lldp chassis tlv med power enable
```

To enable the MED TLV on port 1/1/4, enter the following command at the CLI prompt:

```
-> lldp port 1/1/4 tlv med capability enable
```

To disable the MED TLV on a switch, enter the **lldp tlv med** command, as shown:

```
-> lldp chassis tlv med power disable
```

To disable MED TLV on port 1/1/3, enter the following command at the CLI prompt:

```
-> lldp port 1/1/3 tlv med capability disable
```

Enabling and Disabling Application Priority TLV

The **lldp tlv application** command is used to include the LLDP-DCBx Application Priority TLV in the LLDPDUs transmitted on a specific port, a slot, or all ports on a switch. When enabled, the LLDPDU administrative status must be in the transmit state.

To enable the Application Priority TLV LLDPDU transmission on a switch, enter the **lldp tlv application** command, as shown:

```
-> lldp chassis tlv application enable
```

To enable the Application Priority TLV on port 1/1/4, enter the following command at the CLI prompt:

```
-> lldp port 1/1/4 tlv application enable
```

To disable the Application Priority TLV on a switch, enter the **lldp tlv application** command, as shown:

```
-> lldp chassis tlv application disable
```

To disable the Application Priority TLV on port 1/1/3, enter the following command at the CLI prompt:

```
-> lldp port 1/1/3 tlv application disable
```

To enable the Application Priority TLV on port 1/1/4 for nearest-bridge LLDP agent, enter the following command at the CLI prompt:

```
-> lldp nearest-bridge port 1/1/3 application enable
```

Setting the Transmit Interval

To set the transmit time interval for LLDPDU, enter the **lldp transmit** command. For example, to set the transmit time interval as 50 seconds, enter:

```
-> lldp transmit interval 50
```

To set the **credit-max** value for LLDPDU, the number of consecutive LLDPDU that can be transmitted at any time, enter:

```
-> lldp credit max num 25
```

To set the **fast-init** value for LLDPDU, The number of consecutive LLDPDU that can be transmitted when MED endpoint neighbor is detected, enter:

```
-> lldp fast-init num 5
```

To set the **fast-transmit** value for LLDPDU, time interval between transmissions during fast transmission period, enter:

```
-> lldp fast-transmit seconds 5
```

Setting the Transmit Hold Multiplier Value

To set the transmit hold multiplier value, enter the **lldp transmit hold-multiplier** command. For example, to set the transmit hold multiplier value to 2, enter:

```
-> lldp transmit hold-multiplier 2
```

Note: The Time To Live is a multiple of the transmit interval and transmit hold-multiplier.

Setting the Reinit Delay

To set the time interval that must elapse before the current status of a port is reinitialized after a status change, enter the **lldp reinit delay** command. For example, to set the reinit delay to 7 seconds, enter:

```
-> lldp reinit delay 7
```

Setting the Notification Interval

To set the time interval that must elapse before a notification about the local system Management Information Base (MIB) change is generated, enter the **lldp notification interval** command. For example, to set the notification value to 130 seconds, enter:

```
-> lldp notification interval 130
```

Note: In a specified interval, generating more than one notification-event is not possible.

Verifying 802.1AB Configuration

To display information about the ports configured to handle 802.1AB, use the following show command:

show lldp system-statistics	Displays system-wide statistics.
show lldp statistics	Displays port statistics.
show lldp local-system	Displays local system information.
show lldp local-port	Displays port information.
show lldp local-management-address	Displays the local management address information.
show lldp config	Displays the general LLDP configuration information for LLDP ports.
show lldp network-policy	Displays the MED Network Policy details for a given policy ID.
show lldp med network-policy	Displays the network policy configured on a slot or port. If no option is specified, network policies configured on all ports of the chassis are displayed.
show lldp remote-system	Displays local port information of remote system.
show lldp remote-system med	Displays MED local port information of remote system.
show lldp remote-system application-tlv	Displays Application Priority TLV information of the remote system.
show lldp agent-destination-address	This command shows destination MAC addresses used in LLDPDUs.

For more information about the resulting display, see [Chapter 14, “802.1AB Commands,”](#) in the *OmniSwitch AOS Release 8 CLI Reference Guide*.

15 Configuring SIP Snooping

Session Initiation Protocol (SIP) address the key challenge of real time delivery and monitoring requirements for media streams from SIP devices.

SIP Snooping prioritizes voice and video traffic over non-voice traffic.

- Identifies and marks the SIP and its corresponding media streams. Each media stream contains Real Time Protocol (RTP) and Real Time Control Protocol (RTCP) flows. Marking is done using the DSCP field in the IP header.
- Provides user configured QOS treatment for SIP/RTP/RTCP traffic flows based on its marking.
- Also snoops voice quality metrics of media streams from their RTCP packets and displays them to the user with knowledge of media reception quality in real time and helps to diagnose the problems on their quality. Also in addition, trap will be generated when voice quality parameters like Jitter, Round trip time, Packet-lost, R-factor and MOS values of media streams crosses user configured threshold.

In This Chapter

This chapter describes the SIP Snooping feature, and how to configure it through the Command Line Interface (CLI). For more details about the syntax of commands, see the *OmniSwitch AOS Release 8 CLI Reference Guide*.

The following information and procedures are included in this chapter:

- [“Quick Steps for Configuring SIP Snooping” on page 15-4.](#)
- [“SIP Snooping Overview” on page 15-5](#)
- [“SIP Snooping Configuration Guidelines” on page 15-8](#)
- [“SIP Snooping Limitations” on page 15-15](#)
- [“Verifying the SIP Snooping Configuration” on page 15-16.](#)

SIP Snooping Specifications

The following table lists SIP Snooping specifications.

Standards Supported	RFC 3261 SIP session initiation protocol RFC 6337 SIP USAGE of offer/answer model RFC 4566 SDP session description Protocol RFC 3551 RTP profile for audio and video conferences with minimal control RFC 3311 The Session Initiation Protocol (SIP) UPDATE Method Reliability of Provisional Responses in SIP, RFC 3262
Platforms Supported	OmniSwitch 6860, 6860E

SIP Snooping Defaults

The following table shows SIP Snooping default values.

Parameter Description	Command	Default Value/Comments
The administrative status of SIP Snooping	sip-snooping admin-state	disable
Configure the status of SIP snooping	sip-snooping port admin-state	disable
SIP Snooping mode	sip-snooping mode	automatic
Configure IP address of the trusted servers	sip-snooping trusted server	none
Configure SIP PDU DSCP marking configuration.	sip-snooping sip-control	By default, DSCP is not marked on the switch.
Configure the SOS call strings	sip-snooping sos-call number	none
Configure the SOS-Call RTP/RTCP DSCP Marking	sip-snooping sos-call dscp	EF/46
Configure the UDP port of the switch	sip-snooping udp port	none
Configure the TCP port of the switch	sip-snooping tcp port	port 5260

Parameter Description and Values

No	PARAMETER Description	Default value	Configurable	Min	Max
1	Global SIP snooping	Disable	YES	NA	NA
2	SIP snooping per port	Enable	YES	NA	NA
3	SIP Snooping mode	Automatic	YES	NA	NA
4	Number of SIP UDP Ports	NO	YES	0	8
5	Number of SIP TCP Ports	5260	YES	0	8
6	Number of Trusted Call server	NO	YES		8
7	Number of SOS-Call	NO	YES	0	4
8	SOS-Call RTP/RTCP Bandwidth	128 kbps	NO	NA	NA
9	SOS-Call RTP/RTCP-DSCP	46 EF	YES	NA	NA
10	SIP control DSCP	NO	YES	NA	NA
11	SIP rate limit	1 mbps	NO	1	4
12	Media Idle timeout	5 min	NO	NA	NA
13	RTCP monitoring	Enable	YES	NA	NA
14	Jitter Threshold (audio/video/other)	50/100/100 ms	YES	0	300
15	Packet-lost Threshold (audio/video/other)	10 /20/20 %	YES	0	99
16	RTT Threshold (audio/video/other)	180 /250/250 ms	YES	0	500
17	R-factor Threshold (audio/video/other)	70/80/80	YES	0	100
18	MOS Threshold (audio/video/other)	3.6/3.0/3.0	YES	0	5
19	TCAM slice reserved	1	NO	1	4
20	Number of Media streams per NI ^a	(64*TCAM Slice value) – 4	NO	NA	NA
21	Number of Media streams per system in case of stack. (VC with MAX_NI_SLOTS = 8)	MAXNI_SLOT S * ((64 * TCAM Slice Value) – 4)	NO	NA	NA
22	Number of Media streams per system in case link aggregation as edge port.	(64 * TCAM Slice value) - 4	NO	NA	NA
23	Logging Number of calls	200	YES	50	500

a. Subtracted value of 4 is due to the 15 UDF entries required for SIP method based trapping.

Note. When the Jitter, Packet Lost, and RTT crosses the configured threshold traps are raised. And when the R-factor and MOS goes below the configured threshold traps are raised.

Quick Steps for Configuring SIP Snooping

The following steps provide a quick tutorial on how to configure SIP Snooping. Each step describes a specific operation and provides the CLI command syntax for performing that operation.

1 Create a global SIP policy to classify incoming flows. Use the **policy condition** command to create a QOS condition. For example,

```
-> policy condition Voice sip audio
-> policy condition Video sip video
```

2 Create a policy action for the SIP condition using the **policy action** command. For example,

```
-> policy action DSCP46 dscp 46
-> policy action DSCP32 dscp 32
```

3 Configure the policy rule for the SIP policy to classify inbound and outbound media streams. Use the **policy rule** command. For example,

```
-> policy rule Voice_46 condition Voice action DSCP46
-> policy rule Video_32 condition Video action DSCP32
-> qos apply
```

Note. For more information on policy condition, policy action, and policy rule, see “[Configuring QOS](#)” chapter in the *OmniSwitch AOS Release 8 Network Configuration Guide*.

4 Enable SIP Snooping using the **sip-snooping admin-state** command. For example:

```
-> sip-snooping admin-state enable
```

This command will enable SIP snooping globally.

Note. When SIP snooping is enabled globally the SIP snooping is enabled on all ports and linkagg. The user can disable SIP snooping on specific port or linkagg (see Step 5).

5 Configure port/linkagg level SIP Snooping for the switch. Use the **sip-snooping admin-state** command with the **port** or **linkagg** parameter. For example,

```
-> sip-snooping port 1/1/5-6 admin-state enable
-> sip-snooping linkagg 1/1/10 admin-state enable
```

6 Configure the port/linkagg mode to force-edge for the port to which the SIP phone is connected. Use the **sip-snooping mode** command. For example,

```
-> sip-snooping port 1/1/5-6 mode force-edge
-> sip-snooping linkagg 1/1/10 mode force-edge
```

7 Configure the port/linkagg mode to force-non-edge for uplink port connecting to the call server. Use the **sip-snooping mode** command. For example,

```
-> sip-snooping port 1/5-6 mode force-non-edge
-> sip-snooping linkagg 1/1/10 mode force-non-edge
```

SIP Snooping Overview

The Session Initiation Protocol (SIP) is an IETF-defined signaling protocol widely used for controlling communication sessions such as voice and video calls over Internet Protocol (IP). The protocol can be used for creating, modifying and terminating media sessions. Sessions may consist of one or several media streams.

Other SIP applications include video conferencing, streaming multimedia distribution, instant messaging, presence information, file transfer and online games.

The SIP protocol is an Application Layer protocol designed to be independent of the underlying Transport Layer. SIP can run on the Transmission Control Protocol (TCP), User Datagram Protocol (UDP), or Stream Control Transmission Protocol (SCTP). It is a text-based protocol, incorporating many elements of the Hypertext Transfer Protocol (HTTP) and the Simple Mail Transfer Protocol (SMTP).

The SIP Snooping feature is provided to address the key challenge of real time delivery and monitoring requirements for media streams from SIP devices. The feature allows automatic detection of SIP and its corresponding media streams.

The network is the most critical part of the enterprise infrastructure in delivering diverse applications. Ever increasing applications and their need for network resources keep demand on networks high.

- Critical applications like real-time voice, video, and mission critical data applications continue to grow.
- Bandwidth needs are growing at a faster pace than the network technologies that need to address them.
- Elastic traffic, such as TCP-based non-real time traffic, tends to use any additional bandwidth available.

It is essential to differentiate the various types of traffic, based on application, user, and context, and provide applicable service levels for each.

- Voice and video traffic should be prioritized over non-voice traffic.
- Mission critical data traffic should be provided a bandwidth guarantee for better performance.

The network should be able to monitor the quality of this traffic and inform the user if it is not within the required expectation. SIP Snooping addresses this issue for media streams managed by SIP.

The SIP snooping feature snoops voice quality metrics of media streams from their corresponding control packets and displays them to the user with knowledge of media reception quality in real time and helps to diagnose the problems on their quality. In addition, a trap is generated when the voice quality parameters crosses a user configured threshold.

Using SIP Snooping

A SIP network consists of the following network elements:

- Edge switches, aggregation switches, and core switches
- SIP user agents (e.g., SIP phones). SIP user agents are directly connected to edge switches

One SIP Server is connected to the Core switch within the campus infrastructure. The server is responsible for all the SIP functions such as registrar, proxy, redirect, gateway.

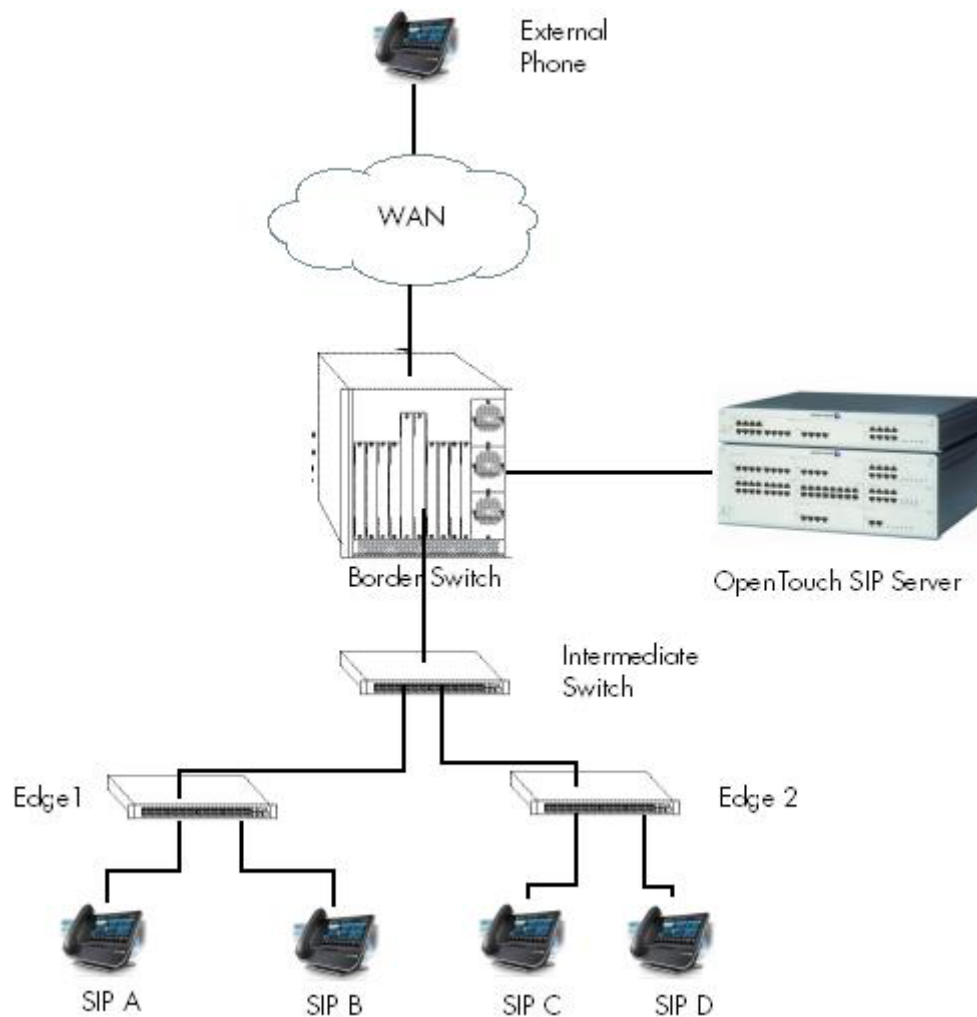

In the above network, SIP-snooping is enabled on the edge switches.

- For an internal call, QOS treatment is enforced on both edge switches on which the SIP user agent endpoints are connected. On each edge switch, the QOS treatment is enforced for both ingress and egress media streams.
- For an external call, QOS treatment is only enforced on the edge switch on which the internal SIP user agent endpoint is connected. The media streams traversing the aggregation and core switches will not be subject to the SIP QOS treatment. On the edge switch, the QOS treatment is enforced for both ingress and egress media streams.

Interoperability

SIP Snooping can interact with the following equipment:

No	Equipment	Description
1	OpenTouch Business Edition 1.1 Server 500 Users (OTBE)	SIP based server from Alcatel Lucent
2	Alcatel Lucent OXE IP Media Gateway MR3	Part of OTBE
3	Alcatel Lucent PCX Enterprise RM3	Part of OTBE
4	Open Touch soft-phone - My Instant Communicator	Part of OTBE
5	8082 My IC Phone	OpenTouch SIP Phone
6	LifeSize Passport(Model: LFZ014)	SIP endpoint

SIP Snooping Configuration Guidelines

This section describes how to use Alcatel-Lucent's Command Line Interface (CLI) commands to configure SIP Snooping on a switch. Consider the following guidelines when configuring SIP Snooping entities:

Configuring Edge Port

SIP snooping requires that the uplink ports are configured as non-edge port. An edge port is a port on which the SIP user agent is connected. A non-edge port is the uplink port on which no SIP user agent is connected but requires SIP snooping. All AOS features available for an edge port are supported with SIP snooping.

By default, the edge and non-edge port modes are implicitly based on LLDP.

- A port that learns a LLDP remote agent advertising the “switch/router” capability is considered a non-edge port.
- A port that does not learn a LLDP remote agent advertising the “switch/router” capability is considered an edge port. A port can be forced to the edge or non-edge mode.

To configure the force-edge/force-non-edge, use the command as follows.

```
-> sip-snooping port 1/1/5-6 mode force-edge
-> sip-snooping port 1/1/10 mode force-non-edge
```

On the edge switch, it is recommended to disable auto phone with the **qos no phones** command. For example

```
-> qos no phones
```

Set all edge ports, including network edge ports to the un-trusted mode. Also ensure uplink port and all the traversing ports to other SIP endpoint are in trust mode.

Configuring Trusted SIP Server

By default, any SIP server is trusted. The SIP messages are trusted regardless of the origin (e.g., source IP address) or destination (e.g., destination IP address) of the SIP message.

The SIP snooping feature allows the configuration of trusted SIP servers. This restricts the SIP snooping functions to only a list of trusted server IP address.

Up to 8 trusted addresses can be configured as trusted SIP server. For configuring the trusted SIP server, use the command

```
-> sip-snooping trusted-server 192.168.0.1
```

All SIP based calls using other than configured trusted call server will not be subject to the configured SIP QOS treatment

Configuring SIP Snooping TCP Ports

The SIP snooping feature allows the configuration of TCP ports. This allows the SIP snooping functions to a list of TCP ports, SIP packets sent/received on the TCP ports will be snooped. A maximum of 8 TCP ports can be configured on a switch.

To configure the Server listening TCP ports, use the [sip-snooping TCP port](#) as follows

```
-> sip-snooping tcp-port 5678 5051
```

The SIP Snooping TCP port configuration is used to snoop the SIP packets, when the SIP endpoints switches from UDP to TCP to send SIP packets of more than 1300 bytes in size.

Configuring SIP Snooping UDP Ports

The SIP snooping feature allows the configuration of UDP ports. This allows the SIP snooping functions to a list of UDP ports, SIP packets sent/received on the UDP ports will be snooped. A maximum of 8 UDP ports can be configured on a switch.

To configure the Server listening UDP port, use the [sip-snooping UDP port](#) as follows

```
-> sip-snooping udp-port 5260 5060
```

This allows the SIP snooping functionality for the configured UDP ports only.

Configuring the SIP Control DSCP

To configure SIP control DSCP marking, use the [sip-snooping sip-control](#) command

```
-> sip-snooping sip-control dscp 40
```

This marks the SIP messages with the configured SIP control DSCP.

Configuring SOS Calls

The SIP snooping features allow the detection of emergency calls based on the “to” URI in the INVITE message. Configuration allows up to 4 SOS call strings to be configured. The string must be the exact URI to be matched in the “to” URI.

When a call is deemed to be a SOS call, a default DSCP of 46 (EF) is assigned for both RTP and RTCP flows of that call. SOS-Call DSCP can be configured to any value. A non-configurable rate limiter of 128kbps is imposed for SOS-Call.

```
-> sip-snooping sos-call number "911" "2233"
```

By default, no SOS number is configured for SIP Snooping

Configuring SOS Call DSCP

To configure the SOS-Call RTP/RTCP DSCP Marking, use the [sip-snooping sos-call](#) command.

```
-> sip-snooping sos-call dscp 56
```

This marks the SOS-Call RTP/RTCP packets with the configured SOS call dscp.

Configuring RTCP Thresholds

When RTCP monitoring is enabled, the SIP snooping feature also inspects the RTCP packet that carries performance metric for the RTP flow.

Depending on the RTCP capabilities of the SIP user agent endpoints, the following metrics can be determined by software:

- Packet loss
- Round Trip Time
- R Factor Only supported with RTCP-XR
- MOS factor – Only supported with RTCP-XR

The SIP snooping feature offers configurable thresholds for each performance metric and each media types.

```
-> sip-snooping threshold audio jitter 30
-> sip-snooping threshold video jitter 50
-> sip-snooping threshold audio packet-lost 40
-> sip-snooping threshold video packet-lost 30
-> sip-snooping threshold audio round-trip-delay 180
-> sip-snooping threshold video round-trip-delay 180
-> sip-snooping threshold audio R-factor 30
-> sip-snooping threshold video R-factor 30
-> sip-snooping threshold audio MOS 1
-> sip-snooping threshold video MOS 2
```

Configuring the Logging Threshold for the Number of Calls

To configure the threshold for the number of call records to be logged on to the flash file, use the [sip-snooping logging-threshold num-of-calls](#) command as follows

```
-> sip-snooping logging-threshold num-of-calls 300
```

Configuring Policy Rules for SIP Snooping

Unlike regular policy rule, a SIP policy rule is not programmed in the hardware when it is configured. The ACL is only programmed when the SIP snooping module detects a new RTP flow and parses the SIP policy rules to determine the QOS policy actions required for this RTP flow.

Policy Condition

All other policy conditions are still supported for the SIP policy rules. This allows specific QOS treatments (policy actions) for media streams based on the origin of the call. For instance, a SIP policy condition can be combined with:

- Source port
- Source IP address/subnet

To configure the policy condition, use the commands as follows.

```
-> policy condition <condition_name> sip {audio | video | other}
-> policy condition <condition_name> sip {audio | video | other}source port 1/2
```

Other source conditions are also supported but are not foreseen to provide real benefits.

The policy condition is not used as such in the hardware filtering entry, but is used by the SIP snooping module to determine the policy rule that the new RTP flow is matching. Also, SIP policy rules are supported in ingress and UNP policy lists.

Policy Action

All other policy actions are still supported for SIP policy rules. For instance:

- DSCP—marks the DSCP value for the RTP/RTCP packets and maps the internal priority to this DSCP
- Priority—forces the internal priority of the RTP/RTCP packets.
- Rate Limiter

To configure the policy action, use the commands as follows.

```
-> policy action <action_name> dscp 32 rtcp-monitoring {enable | disable}
-> policy action <action_name> dscp 46 rtcp-monitoring enable rtcp-dscp <num>
-> policy action <action_name> rtcp-monitoring disable trust-dscp
```

Policy Rule

A SIP policy rule is a rule that has the keyword SIP (audio/video/other) in the policy condition and a corresponding policy action.

The SIP policy rule is configured as follows.

```
-> policy condition Voice_srcip_SIP1 source ip 10.10.0.0 mask 255.255.0.0 sip
audio
-> policy condition Video_srcip_SIP1 source ip 10.10.0.0 mask 255.255.0.0 sip
video
-> policy action DSCP56 dscp 56
-> policy action DSCP32 dscp 32
-> policy rule Voice_srcip_SIP1_rule condition Voice_srcip_SIP1 action DSCP56
-> policy rule Video_srcip_SIP1_rule condition Video_srcip_SIP1 action DSCP32
-> qos apply
```

Note that a SIP policy rule does not apply for the SIP signaling messages. A SIP policy rule can however apply for a SOS call since a SOS call is a audio media. However, the DSCP marking and rate limiter for an SOS call cannot be overwritten by a SIP policy rule.

Unsupported Topologies

The SIP snooping functions and the QOS actions require that the network paths used by the SIP signaling messages and the RTP/RTCP flows are the same and are “symmetric”. For this reason, the following topologies are not supported:

- ECMP Routing
- VRRP

In such topologies, it would be possible that one switch/router sees the SIP signaling messages and creates the dialog with the appropriate QOS actions (i.e. ACLs), but the RTP/RTCP traffic will not be seen by this switch/router. It would also be possible that the SIP signaling messages and/or RTP/RTCP packets are load balanced between 2 switch/routers.

SIP Snooping Use Case

In this section, advanced SIP configuration use cases are illustrated. Instead of having all voice audio/video media streams treated the same way, more granular SIP policies can be configured.

Expectations

- Voice media streams from SIP1 to SIP2 will be marked with DSCP 56
- Video media streams from Video SIP1 to Video SIP2 will be marked with DSCP 32
- Voice media streams from SIP2 to SIP1 will be marked with DSCP 46
- Voice media streams from Video SIP2 to Video SIP1 will be marked with DSCP 48

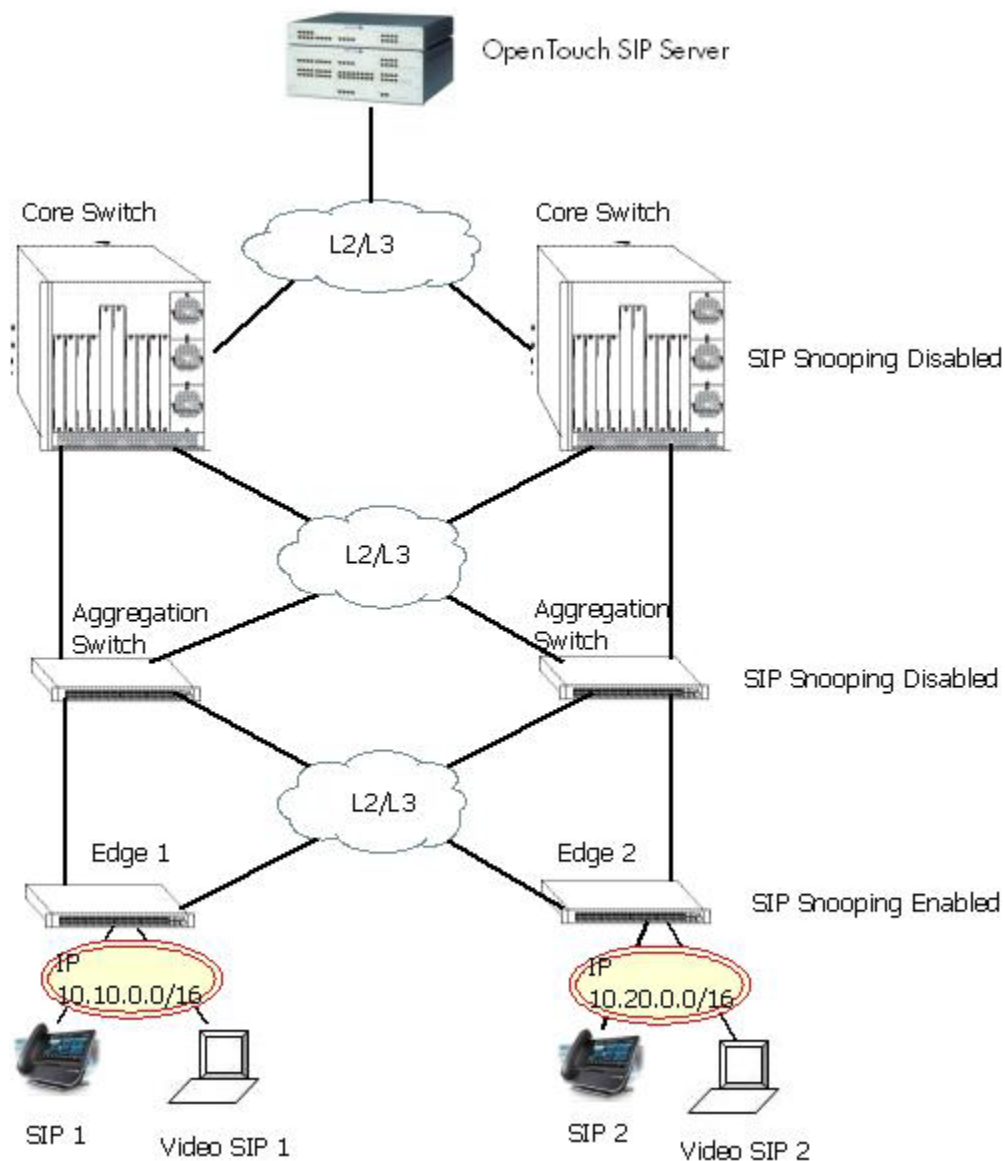

SIP Condition

In this example, specific QOS treatments are configured based on the source IP subnet.

- Voice source IP subnet 10.10.0.0 = DSCP 56
- Video source IP subnet 10.10.0.0=DSCP 32
- Voice source IP subnet 10.20.0.0 = DSCP 46
- Video source IP subnet 10.20.0.0=DSCP 48

The SIP conditions is configured as follows:

```
-> policy condition Voice_srcip_SIP1 source ip 10.10.0.0 mask 255.255.0.0 sip
audio
-> policy condition Video_srcip_SIP1 source ip 10.10.0.0 mask 255.255.0.0 sip
video
-> policy condition Voice_srcip_SIP2 source ip 10.20.0.0 mask 255.255.0.0 sip
audio
-> policy condition Video_srcip_SIP2 source ip 10.20.0.0 mask 255.255.0.0 sip
video
-> policy action DSCP56 dscp 56
-> policy action DSCP32 dscp 32
-> policy action DSCP46 dscp 46
-> policy action DSCP48 dscp 48
-> policy rule Voice_srcip_SIP1_rule condition Voice_srcip_SIP1 action DSCP56
-> policy rule Video_srcip_SIP1_rule condition Video_srcip_SIP1 action DSCP32
-> policy rule Voice_srcip_SIP2_rule condition Voice_srcip_SIP2 action DSCP46
-> policy rule Video_srcip_SIP2_rule condition Video_srcip_SIP2 action DSCP48
-> qos apply
```

The active call records can be viewed by using the following command:

```
-> show sip-snooping call-records active-calls full
Legend: start date time duration media-type end-reason
        call-id / from-tag / to-tag
        IP address port DSCP (forward/reverse)
        policy-rule (F/R)

        statistics min / max / avg %samples exceeding threshold (F/R)

-----
2013-11-21 18:39:17(PST) 0d 16h 13m 41s Audio -
6dddf3236f2d564c / dlfc26f8da / 0061D0A0-7C50-1200-83AF-F1A3FE87AA77-1439499
IP/DSCP          5.5.5.2 6000 NA/NA          7.7.7.2 6000 NA/NA
Policy-Rule      r6          r1
Pkt-Count        2920807 2920807
Pkt-Loss         0          0          0.00          0% 0          0          0.00          0%
Jitter           1          198714     17.34         0% 1          49          0.32          0%
Delay            9          29         16.44         0% 9          29          16.44         0%
R-factor         35         96         35.42         99% 30         96          32.00         99%
MOS              1.00       4.00       1.80          99% 1.00       4.00       1.60          99%

-----

Number of Call Records: 1
```

```

-> show sip-snooping call-records ended-calls full
Legend: start date time duration media-type end-reason
       call-id / from-tag / to-tag
       IP address port DSCP (forward/reverse)
       policy-rule (F/R)
       Pkt count (F/R)

       statistics min / max / avg %samples exceeding threshold (F/R)
-----
2002-04-06 01:06:10 UTC 0d 0h 4m 15s   Audio   -
0010CFC0-4A05-10DA-B960-F1A3FE87AA77-23025@ot380.aos.com / 0010CFE8-4A05-10DA-B960-
F1A3FE87AA77-258649 / 1668946822
IP/DSCP      10.20.0.2 6000 56/56   10.10.0.2 6000 46/46
Policy-Rule   Voice_srcip_SIP1_rule   Voice_srcip_SIP2_rule
Pkt-Count     12272   61385
Pkt-Loss      0       0           0.00           0% 0       0           0.00
0%
Jitter        0       0           0.00           0% 0       0           0.00
0%
Delay         0       0           0.00           0% 0       0           0.00
0%
R-factor      0       0           0.00           0% 96      96          96.00
0%
MOS           0       0           0.00           0% 44      44          44.00
-----
Number of Call Records: 1

```

Similar to the above example, more conditions can be combined in a single SIP rule.

Advanced RTCP Control

For each RTP flow, RTCP monitoring can be enabled or disabled. When enabled, the DSCP marking can also be controlled. Also Trap will be generated if RTCP parameters exceed the Threshold values configured in SIP configuration.

In this example, specific QOS treatments are configured based on the Source IP subnet.

- Voice source IP subnet 10.10.0.0 = DSCP 56— RTCP packets for these RTP flows are trapped to CPU and assigned with DSCP 56.

```
-> policy action DSCP56 dscp 56
```

- Video source IP subnet 10.10.0.0= RTCP—packets for these RTP flows are trapped to CPU and have their DSCP unchanged.

```
-> policy action DSCP32 rtcp-monitoring enable trust-DSCP
```

- Voice source IP subnet 10.20.0.0 = DSCP 46 + No RTCP monitoring—RTCP packets for these RTP flows are not trapped to CPU and assigned with DSCP 46.

```
-> policy action DSCP46 dscp 46 rtcp-monitoring disable
```

- Video source IP subnet 10.20.0.0 = DSCP 48 + RTCP monitoring and explicit DSCP 46—RTCP packets for these RTP flows are trapped to CPU and assigned with DSCP 46.

```
-> policy action DSCP48 dscp 48 rtcp-monitoring enable rtcp-dscp 46
```

SIP Snooping Limitations

- Media types other than audio and video as application, image media types etc. are not supported.
- Solution only supports SIP, no support of NOE (New Office Environment).
- SIP Registrar, outbound proxy, proxy, redirect functions should be provided by the same server called the SIP Server.
- All initial SIP messages between User Agents must go through the SIP Server. Direct SIP session establishment between end users will be not supported.
- Outbound proxy configured on phone and trusted call server configured on switch must be the same.
- Only SIP over UDP and SIP over UDP/TCP is supported. Solution does not support SIP over SCTP or MPLS and SIP over TLS.
- Encrypted RTCP or SDP is not supported.
- Only SIP over IPv4 is supported, no support for IPV6.
- Multicast Media Sessions by SIP is not supported
- Only RTP or RTP profile AVP is supported to carry media. SAVP, AVPF, SAVPF are not supported.
- Only IP address is supported. DNS resolution and FQDN name are not supported in SDP
- Only audio and video application in "m" line of SDP is supported.
- No network performance reporting other than RTCP reports.
- RTCP port assignment is taken as one higher than corresponding RTP. Other methods for RTCP port assignment is not supported
- Media quality metrics displayed to the user only convey the presence of problem in voice and video transmission quality. Exact location and device responsible for it will not be known and it is expected that the user will find it by other means and take corrective action.
- QOS SIP policy modifications should be applied for the new calls only and not for existing ones.
- DSCP marking will be done for only $[(64 * \text{TCAM Slice Value}) - 4]$ SIP audio calls, if a call is through linkagg on a stack.
- No VRF awareness. Similarly, NAT transversal (ICE, TURN, STUN solution) is not supported.
- Emergency call identification is based on user configured string. Usage of priority or resource-priority header is not considered.
- SIP IP address and RTP IP address of end point at edge port must be same, otherwise TCAM entries will not be created.
- Media that flows before TCAM entries are installed does not get configured QOS treatment.

Verifying the SIP Snooping Configuration

To display information about Sip Snooping on the switch, use the show commands listed below:

show sip-snooping config	Shows the SIP snooping configuration.
show sip-snooping ports	Displays the SIP snooping port level data.
show sip-snooping call-records	Displays the SIP-snooping active/ended call records.
show sip-snooping statistics	Displays the SIP snooping statistics.
show qos dscp-table	Displays the QoS DSCP table configured.

16 Configuring IP

Internet Protocol (IP) is primarily a network-layer (Layer 3) protocol that contains addressing and control information that enables packets to be forwarded. Along with Transmission Control Protocol (TCP), IP represents the heart of the Internet protocols. IP has two primary responsibilities, providing connectionless, best-effort delivery of datagrams through an internetwork; and providing fragmentation and reassembly of datagrams to support data links with different Maximum Transmission Unit (MTU) sizes.

Note. IP routing (Layer 3) can be accomplished using static routes or by using one of the IP routing protocols, Routing Information Protocol (RIP) and Open Shortest Path First (OSPF). For more information on these protocols see [Chapter 20, “Configuring RIP,”](#) in this manual; or “Configuring OSPF” in the *OmniSwitch AOS Release 8 Advanced Routing Configuration Guide*.

Two versions of Internet Protocol is supported - IPv4 and IPv6. For more information about using IPv6, see [Chapter 18, “Configuring IPv6.”](#)

In This Chapter

This chapter describes IP and how to configure it through the Command Line Interface (CLI). It includes instructions for enabling IP forwarding, configuring IP route maps, as well as basic IP configuration commands (for example, `ip default-ttl`). CLI commands are used in the configuration examples; for more details about the syntax of commands, see the *OmniSwitch AOS Release 8 CLI Reference Guide*. This chapter provides an overview of IP and includes information about the following procedures:

- IP Forwarding
 - Configuring an IP Interface (see [page 16-8](#))
 - Configuring a Managed IP Interface (see [page 16-11](#))
 - Creating a Static Route or Recursive Static Route (see [page 16-11](#))
 - Creating a Default Route (see [page 16-13](#))
 - Configuring Address Resolution Protocol (ARP) (see [page 16-13](#))
- IP Configuration
 - Configuring the Router Primary Address (see [page 16-17](#))
 - Configuring the Router ID (see [page 16-17](#))
 - Configuring the Time-to-Live (TTL) Value (see [page 16-18](#))
 - Configuring Route Map Redistribution (see [page 16-18](#))
 - IP-Directed Broadcasts (see [page 16-24](#))
 - Protecting the Switch from Denial of Service (DoS) attacks (see [page 16-24](#))

- Managing IP
 - Internet Control Message Protocol (ICMP) (see [page 16-30](#))
 - Using the Ping Command (see [page 16-32](#))
 - Tracing an IP Route (see [page 16-33](#))
 - Displaying TCP Information (see [page 16-33](#))
 - Displaying User Datagram Protocol (UDP) Information (see [page 16-34](#))
 - Service Assurance Agent (SAA) (see [page 16-34](#))
- Tunneling
 - Generic Routing Encapsulation ([page 16-34](#))
 - IP Encapsulation within IP ([page 16-34](#))
 - Tunneling operation ([page 16-35](#))
 - Configuring a Tunnel Interface ([page 16-36](#))
- VRF Route Leak
 - Quick Steps for Configuring VRF Route Leak ([page 16-38](#))
 - Configuring VRF Route Leak ([page 16-39](#))
 - Verifying VRF Route Leak Configuration ([page 16-40](#))

IP Specifications

The maximum limit values provided in the following Specifications table are subject to available system resources:

Platforms Supported	OmniSwitch 6860, 6860E
RFCs Supported	791–Internet Protocol 792–Internet Control Message Protocol 826–An Ethernet Address Resolution Protocol 2784–Generic Routing Encapsulation (GRE) 2890–Key and Sequence Number Extensions to GRE (extensions defined are not supported) 1701–Generic Routing Encapsulation (GRE) 1702–Generic Routing Encapsulation over IPV4 Networks 2003–IP Encapsulation within IP
Maximum router interfaces per system	4K
Maximum router interfaces per VLAN	16
Maximum routes	64K
Maximum static routes	1K
Maximum HW ARP entries per module	16K
Maximum number of GRE tunnel interfaces per switch	127
Maximum number of IPIP tunnel interfaces per switch	127
Maximum next hops per ECMP entry (static or RIP routes)	16

IP Defaults

The following table lists the defaults for IP configuration through the **ip** command.

Description	Command	Default
IP-Directed Broadcasts	ip directed-broadcast	disable
Time-to-Live Value	ip default-ttl	64 (hops)
IP interfaces	ip interface	VLAN 1 interface.
ARP filters	arp filter	0

Quick Steps for Configuring IP Forwarding

Using only IP, which is always enabled on the switch, devices connected to ports on the same VLAN are able to communicate at Layer 2. The initial configuration for all Alcatel-Lucent switches consists of a default VLAN 1. All switch ports are initially assigned to this VLAN. If additional VLANs are not configured on the switch, the entire switch is treated as one large broadcast domain, and all ports receive all traffic from all other ports.

Note. The operational status of a VLAN remains inactive until at least one active switch port is assigned to the VLAN. If the ports are connected to an active network device, they are considered active. Non-active port assignments are allowed, but do not change the operational state of the VLAN.

To forward packets to a different VLAN on a switch, create an IP interface on each VLAN. The following steps provide a quick tutorial of how to enable IP forwarding between VLANs “from scratch”. If active VLANs have already been created on the switch, you only need to create IP interfaces on each VLAN (Steps 5 and 6).

- 1 Create VLAN 10 with a description (for example, VLAN 10) using the **vlan** command. For example:

```
-> vlan 10 name "VLAN 10"
```

- 2 Create VLAN 20 with a description (for example, VLAN 20) using the **vlan** command. For example:

```
-> vlan 20 name "VLAN 20"
```

- 3 Assign an active port to VLAN 10 using the **vlan members untagged** command. For example:

```
-> vlan 10 members port 1/1/1 untagged
```

- 4 Assign an active port to VLAN 20 using the **vlan members** command. For example:

```
-> vlan 20 members port 1/1/2 untagged
```

- 5 Create an IP interface on VLAN 10 using the **ip interface** command. For example:

```
-> ip interface vlan-10 address 171.10.1.1 vlan 10
```

- 6 Create an IP interface on VLAN 20 using the **ip interface** command. For example:

```
-> ip interface vlan-20 address 171.11.1.1 vlan 20
```

Note. See [Chapter 4, “Configuring VLANs,”](#) for more information about how to create VLANs.

IP Overview

IP is a network-layer (Layer 3) protocol that contains addressing and control information that enables packets to be forwarded on a network. IP is the primary network-layer protocol in the Internet protocol suite. Along with TCP, IP represents the heart of the Internet protocols.

IP Protocols

IP is associated with Layer 3 and Layer 4 protocols. These protocols are built into the base code loaded on the switch. A brief overview of the supported IP protocols is described in the following sections.

Transport Protocols

IP is both connectionless (it forwards each datagram separately) and unreliable (it does not guarantee delivery of datagrams). This means that a datagram can be damaged in transit, thrown away by a busy switch, or never make it to its destination. The resolution of these transit problems is to use a Layer 4-transport protocol, such as:

- TCP—A major data transport mechanism that provides reliable, connection-oriented, full-duplex data streams. While the role of TCP is to add reliability to IP, TCP relies upon IP to do the actual delivering of datagrams.
- UDP—A secondary transport-layer protocol that uses IP for delivery. UDP is not connection-oriented and does not provide reliable end-to-end delivery of datagrams. Few applications can safely use UDP to send datagrams that do not require the extra overhead added by TCP. For more information on UDP, see [Chapter 22, “Configuring DHCP Relay.”](#)

Application-Layer Protocols

Application-layer protocols are used for switch configuration and management:

- Bootstrap Protocol (BOOTP)/Dynamic Host Configuration Protocol (DHCP)—can be used by an end station to obtain an IP address. The switch provides a DHCP Relay that allows BOOTP requests/replies to cross different networks.
- Simple Network Management Protocol (SNMP)—Allows communication between SNMP managers and SNMP agents on an IP network. Network administrators use SNMP to monitor network performance and manage network resources. For more information, see the “Using SNMP” chapter in the *OmniSwitch AOS Release 8 Switch Management Guide*.
- Telnet—Used for remote connections to a device. You can telnet to a switch and configure the switch and the network by using the CLI.
- SSH—Used for remote connections to a device. You can SSH to a switch and configure the switch and the network by using the CLI.
- File Transfer Protocol (FTP)—Enables the transfer of files between hosts. This protocol is used to load new images onto the switch.

Additional IP Protocols

Many additional IP-related protocols can be used with IP forwarding. These protocols are included as part of the base code.

- Address Resolution Protocol (ARP)—Used to match the IP address of a device with its physical (MAC) address. For more information, see [“Configuring Address Resolution Protocol \(ARP\)” on page 16-13.](#)
- Virtual Router Redundancy Protocol (VRRP)—Used to back up routers. For more information, see [Chapter 24, “Configuring VRRP.”](#)
- Internet Control Message Protocol (ICMP)—Specifies the generation of error messages, test packets, and informational messages related to IP. ICMP supports the **ping** command used to determine if hosts are online. For more information, see [“Internet Control Message Protocol \(ICMP\)” on page 16-30.](#)
- Multicast Services—Includes IP multicast switching (IPMS). For more information, see [Chapter 26, “Configuring IP Multicast Switching.”](#)

IP Forwarding

Network device traffic is bridged (switched) at the Layer-2 level between ports that are assigned to the same VLAN. However, if a device needs to communicate with another device that belongs to a different VLAN, then Layer 3 routing is necessary to transmit traffic between the VLANs. Bridging decides to forward the packets based on the destination MAC address of the packet. Routing decides on where to forward packets based on the IP network address of the packet (for example, IP - 21.0.0.10).

Alcatel-Lucent switches support routing of IP traffic. A VLAN is available for routing when at least one router interface is defined for that VLAN and at least one active port is associated with the VLAN. If a VLAN does not have a router interface, the ports associated with that VLAN are in essence firewalled from other VLANs.

IP multi-netting is also supported. A network is said to be multi-netted when multiple IP subnets are brought together within a single broadcast domain. Each interface is configured with a different subnet. As a result, traffic from each configured subnet can coexist on the same VLAN.

In the illustration below, an IP router interface has been configured on each VLAN. Therefore, workstations connected to ports on VLAN 1 on Switch 1 can communicate with VLAN 2; and workstations connected to ports on VLAN 3 on Switch 2 can communicate with VLAN 2. Also, ports from both switches have been assigned to VLAN 2, and a physical connection has been made between the switches. Therefore, workstations connected to VLAN 1 on Switch 1 can communicate with workstations connected to VLAN 3 on Switch 2.

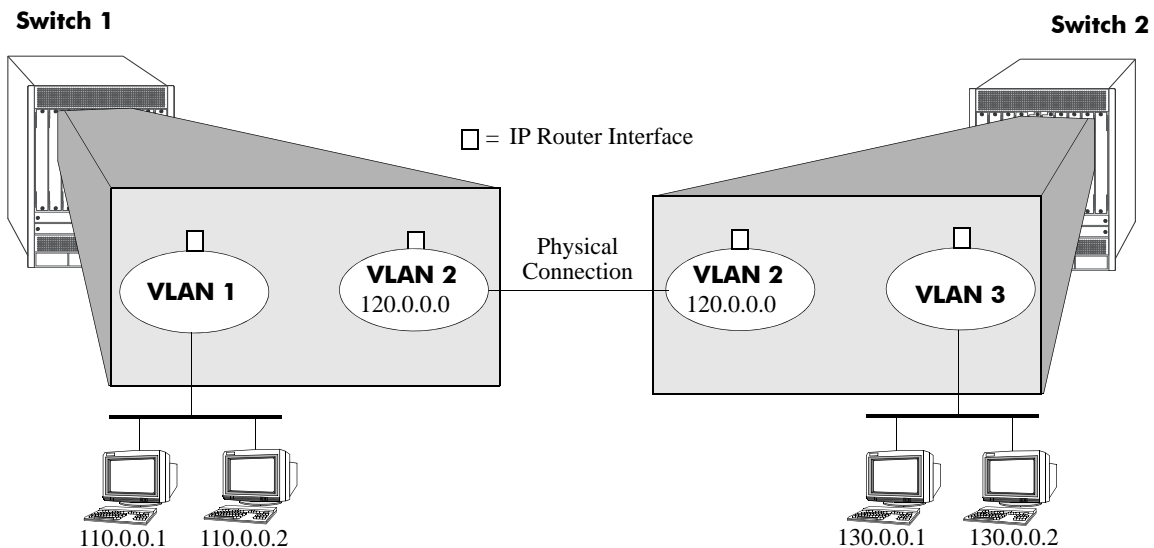

IP Forwarding

Configuring an IP Interface

IP is enabled by default. Using IP, devices connected to ports on the same VLAN are able to communicate. However, to forward packets to a different VLAN, create at least one IP interface on each VLAN.

Use the **ip interface** command to define IP interfaces for an existing VLAN. The following parameter values are configured with this command:

- A unique interface name (text string up to 16 characters) is used to identify the IP interface. Specifying this parameter is required to create or modify an IP interface.
- The VLAN ID of an existing VLAN.
- An IP address to assign to the interface (for example, 193.204.173.21). Router interface IP addresses must be unique. You cannot have two-router interfaces with the same IP address.
- A subnet mask (defaults to the IP address class). It is possible to specify the mask in dotted decimal notation (for example, 255.255.0.0) or with a slash (/) after the IP address followed by the number of bits to specify the mask length (for example, 193.204.173.21/24).
- The forwarding status for the interface (defaults to forwarding). A forwarding router interface sends IP frames to other subnets. A router interface that is not forwarding can receive frames from other hosts on the same subnet.
- An Ethernet-II or SNAP encapsulation for the interface (defaults to Ethernet-II). The encapsulation determines the framing type the interface uses when generating frames that are forwarded out of VLAN ports. Select an encapsulation that matches the encapsulation of the majority of VLAN traffic.
- The Local Proxy ARP status for the VLAN. If enabled, traffic within the VLAN is routed instead of bridged. ARP requests return the MAC address of the IP router interface defined for the VLAN. For more information about Local Proxy ARP, see [“Local Proxy ARP” on page 16-15](#).
- The primary interface status. Designates the specified IP interface as the primary interface for the VLAN. By default, the first interface bound to a VLAN becomes the primary interface for that VLAN.

The following **ip interface** command example creates an IP interface named Marketing with an IP network address of 21.0.0.1 and binds the interface to VLAN 455:

```
-> ip interface Marketing address 21.0.0.1 vlan 455
```

The **name** parameter is the only parameter required with this command. Specifying additional parameters is only necessary to configure a value other than the default value for that parameter. For example, all of the following commands create an IP router interface for VLAN 955 with a class A subnet mask, an enabled forwarding status, Ethernet-II encapsulation, and a disabled Local Proxy ARP and primary interface status:

```
-> ip interface Accounting address 71.0.0.1 mask 255.0.0.0 vlan 955 forward e2  
no local-proxy-arp no primary  
-> ip interface Accounting address 71.0.0.1/8 vlan 955  
-> ip interface Accounting address 71.0.0.1 vlan 955
```

Modifying an IP Router Interface

The **ip interface** command is also used to modify existing IP interface parameter values. It is not necessary to remove the IP interface and then create it again with the new values. The changes specified overwrite existing parameter values. For example, the following command changes the subnet mask to **255.255.255.0**, the forwarding status to **no forwarding** and the encapsulation to **snap** by overwriting existing parameter values defined for the interface. The interface name, **Accounting**, is specified as part of the command syntax to identify which interface to change.

```
-> ip interface Accounting mask 255.255.255.0 no forward snap
```

When changing the IP address for the interface, the subnet mask reverts to the default mask value if it was previously set to a non-default value and it is not specified when changing the IP address. For example, the following command changes the IP address for the Accounting interface:

```
-> ip interface Accounting address 40.0.0.1
```

The subnet mask for the Accounting interface was previously set to 255.255.255.0. The above example resets the mask to the default value of 255.0.0.0 because 40.0.0.1 is a Class A address and no other mask was specified with the command. This only occurs when the IP address is modified; all other parameter values remain unchanged unless otherwise specified.

To avoid the problem in the above example, enter the non-default mask value whenever the IP address is changed for the interface. For example:

```
-> ip interface Accounting address 40.0.0.1 mask 255.255.255.0  
-> ip interface Accounting address 40.0.0.1/8
```

Use the **show ip interface** command to verify IP router interface changes. For more information about these commands, see the *OmniSwitch AOS Release 8 CLI Reference Guide*.

Removing an IP Router Interface

To remove an IP router interface, use the **no** form of the **ip interface** command. It is only necessary to specify the name of the IP interface, as shown in the following example:

```
-> no ip interface Marketing
```

To view a list of IP interfaces configured on the switch, use the **show ip interface** command. For more information about this command, see the *OmniSwitch AOS Release 8 CLI Reference Guide*.

Configuring a Loopback0 Interface

Loopback0 is the name assigned to an IP interface to identify a consistent address for network management purposes. The Loopback0 interface is not bound to any VLAN, so it always remains operationally active. If there are no active ports in the VLAN, all IP interface associated with that VLAN are not active. In addition, the Loopback0 interface provides a unique IP address for the switch that is easily identifiable to network management applications.

This type of interface is created in the same manner as all other IP interfaces, using the [ip interface](#) command. To identify a Loopback0 interface, enter **Loopback0** for the interface name. For example, the following command creates the Loopback0 interface with an IP address of 10.11.4.1:

```
-> ip interface Loopback0 address 10.11.4.1
```

Note the following when configuring the Loopback0 interface:

- The interface name, “Loopback0”, is case sensitive.
- The Loopback0 interface is always active and available.
- Only one Loopback0 interface per switch is allowed.
- Loopback0 address cannot be modified once it is configured.
- Creating this interface does *not* deduct from the total number of IP interfaces allowed per VLAN or switch.
- To change the address, remove the interface using the **no ip interface Loopback0** command and re-add it with the new address.

Loopback0 Address Advertisement

The Loopback0 IP interface address is automatically advertised by the IGP protocols RIP and OSPF when the interface is created. There is no additional configuration necessary to trigger advertisement with these protocols.

Note the following regarding Loopback0 advertisement:

- RIP advertises the host route to the Loopback0 IP interface as a redistributed (directhost) route.
- OSPF advertises the host route to the Loopback0 IP interface in its Router-LSAs (as a Stub link) as an internal route into all its configured areas.

Configuring a BGP Peer Session with Loopback0

It is possible to create BGP peers using the Loopback0 IP interface address of the peering router and binding the source (that is, outgoing IP interface for the TCP connection) to its own configured Loopback0 interface. The Loopback0 IP interface address can be used for both Internal and External BGP peer sessions. For EBGP sessions, if the external peer router is multiple hops away, the **ebgp-multihop** parameter can be used.

The following example command configures a BGP peering session using a Loopback0 IP interface address:

```
-> ip bgp neighbor 2.2.2.2 update-source Loopback0
```

See the *OmniSwitch AOS Release 8 Advanced Routing Configuration Guide* for more information.

Configuring an IP Managed Interface

By default, most applications that run on IP use the egress IP interface address as the source IP, while using a socket to communicate with a peer/server. However, it may be desirable to have some applications use a specific source IP for the packets that are sent out using the socket.

The `ip service source-ip` command provides the ability to configure a permanent source IP interface to send packets. The source IP interface can be the Loopback0 address or user defined IP interface. For example,

The following commands create a Loopback0 interface and configures that interface as a source IP interface for the NTP application:

```
-> ip interface Loopback0 address 10.10.1.1
-> ip service source-ip loopback0 ntp
```

The following command configures user-defined source IP interface for the FTP application:

```
-> ip service source-ip ipVlan100 ftp
```

Notes.

- Use “all” option in the command to configure a common source IP address for the applications. If for a particular application, specific source IP address is configured and the “all” option is also set, the configured source IP address foip r the application is used as the outgoing interface.
 - If a source IP interface is not defined for an application, the application uses the outgoing interface address as the source IP.
-

A source IP address is configurable for the following applications within the VRF context:

Application	Default Source Interface	VRF Support
ASA Authentication Server		
LDAP Server	Outgoing interface	Supported with any VRF (Configuration available only in the default VRF)
TACACS+	Outgoing interface	Supported with any VRF (Configuration available only in the default VRF)
AAA Authentication Server		
RADIUS	Outgoing interface	Supported with any VRF (Configuration available only in the default VRF)
Switch Management Applications		
SNMP (includes traps)	Outgoing interface	Supported with any VRF (Configuration available only in the default VRF)
SFLOW	Outgoing interface	Supported with only default VRF
NTP	Outgoing interface	Supported with any VRF (Configuration available only in the default VRF)

Application	Default Source Interface	VRF Support
SWLOG	Outgoing interface	Supported with any VRF (Configuration available only in the default VRF)
DNS	Outgoing interface	Servers can only be set in the default VRF
Switch Access and Utilities (ping and traceroute command can specify a source address as an optional parameter)		
Telnet	Outgoing interface	Supported with any VRF
FTP	Outgoing interface	Supported with any VRF
SSH (includes scp, sftp)	Outgoing interface	Supported with any VRF
TFTP	Outgoing interface	Supported with any VRF

Creating a Static Route or Recursive Static Route

Static routes are user-defined and carry a higher priority than routes created by dynamic routing protocols. That is, if two routes have the same metric value, the static route has the higher priority. Static routes allow you to define, or customize, an explicit path to an IP network segment, which is then added to the IP Forwarding table. Static routes can be created between VLANs to enable devices on these VLANs to communicate.

Use the **ip static-route** command to create a static route. Specify the destination IP address of the route as well as the IP address of the first hop (gateway/interface) used to reach the destination. For example, to create a static route to IP address 171.11.0.0 through gateway 171.11.2.1, you would enter:

```
-> ip static-route 171.11.0.0 gateway 171.11.2.1
```

For example, to create a static route to IP address 171.11.0.0 through interface Int1 you would enter:

```
-> ip static-route 171.11.0.0 interface Int1
```

If you want to use the natural subnet mask, the subnet mask is not required. By default, the switch imposes a natural mask on the IP address. In the above example, the Class B mask of 255.255.0.0 is implied. If you do not want to use the natural mask, enter a subnet mask. For example, to create a static route to IP address 10.255.11.0, enter the Class C mask of 255.255.255.0:

```
-> ip static-route 10.255.11.0 mask 255.255.255.0 gateway 171.11.2.1
```

Specifying the length of the mask in bits is also supported. For example, the above static route is also configurable using the following command:

```
-> ip static-route 10.255.11.0/24 gateway 171.11.2.1
```

When you create a static route, the default metric value of 1 is used. However, you can change the priority of the route by increasing its metric value. The lower the metric value, the higher the priority. This metric is added to the metric cost of the route. The metric range is 1 to 15. For example:

```
-> ip static-route 10.255.11.0/24 gateway 171.11.2.1 metric 5
```

Static routes do not age out of the IP Forwarding table; delete them from the table. Use the **no ip static route** command to delete a static route. Specify the destination IP address of the route as well as the IP

address of the first hop (gateway). For example, to delete a static route to IP address 171.11.0.0 through gateway 171.11.2.1, you would enter:

```
-> no ip static-route 171.11.0.0 gateway 171.11.2.1
```

The IP Forwarding table includes routes learned through one of the routing protocols (RIP, OSPF, BGP) as well as any static routes that are configured. Use the **show ip routes** command to display the IP Forwarding table.

Creating a Recursive Static Route

Recursive static routes are similar to the static routes described above. However, with a recursive static route the route to reach the gateway is learned through a dynamic routing protocol such as RIP or OSPF. If a better route to the gateway is learned, the path to a recursive route can be changed dynamically. This feature can be used to configure a uniformed static route for all routers on a network, but the path to reach the gateway can differ for each router. To create a recursive static route use the **follows** parameter:

```
-> ip static-route 171.11.0.0 follows 192.168.10.1
```

A route to the **192.168.10.1** address must be learned by a dynamic routing protocol for the recursive static route to be active.

Creating a Default Route

A default route can be configured for packets destined for networks that are unknown to the switch. Use the **ip static-route** command to create a default route. Specify a default route of 0.0.0.0 with a subnet mask of 0.0.0.0 and the IP address of the next hop (gateway). For example, to create a default route through gateway 171.11.2.1 you would enter:

```
-> ip static-route 0.0.0.0 mask 0.0.0.0 gateway 171.11.2.1
```

Specifying the length of the mask in bits is also supported. For example, the above default route is also configurable using the following command:

```
-> ip static-route 0.0.0.0/0 gateway 171.11.2.1
```

Note. You cannot create a default route by using the EMP port as a gateway.

Configuring Address Resolution Protocol (ARP)

To send packets on a locally connected network, the switch uses ARP to match the IP address of a device with its physical (MAC) address. To send a data packet to a device with which it has not previously communicated, the switch first broadcasts an ARP request packet. The ARP request packet requests the Ethernet hardware address corresponding to an Internet address. All hosts on the receiving Ethernet receive the ARP request, but only the host with the specified IP address responds. If present and functioning, the host with the specified IP address responds with an ARP reply packet containing its hardware address. The switch receives the ARP reply packet, stores the hardware address in its ARP cache for future use, and begins exchanging packets with the receiving device.

The switch stores the hardware address in its ARP cache (ARP table). The table contains a listing of IP addresses and their corresponding translations to MAC addresses. Entries in the table are used to translate 32-bit IP addresses into 48-bit Ethernet or IEEE 802.3 hardware addresses. Dynamic addresses remain in the table until they time out. You can set this time-out value and you can also manually add or delete permanent addresses to/from the table.

Adding a Permanent Entry to the ARP Table

As described above, dynamic entries remain in the ARP table for a specified time period before they are automatically removed. However, you can create a permanent entry in the table.

Use the **arp** command to add a permanent entry to the ARP table. Enter the IP address of the entry followed by its physical (MAC) address. For example, to create an entry for IP address 171.11.1.1 with a corresponding physical address of 00:05:02:c0:7f:11, you would enter:

```
-> arp 171.11.1.1 00:05:02:c0:7f:11
```

Configuring a permanent ARP entry with a multicast address is also supported. For example, the following command creates a permanent multicast ARP entry:

```
-> arp 2.2.3.40 01:4a:22:03:44:5c
```

When configuring a static multicast ARP entry, do not use any of the following multicast addresses:

01:00:5E:00:00:00 to 01:00:5E:7F:FF:FF

01:80:C2:XX:XX:XX

33:33:XX:XX:XX:XX

The IP address and hardware address (MAC address) are *required* when you add an entry to the ARP table. Optionally, you can also specify:

- **Alias.** Use the **alias** keyword to specify that the switch acts as an alias (proxy) for this IP address. When the alias option is used, the switch responds to all ARP requests for the specified IP address with its own MAC address. This option is not related to Proxy ARP as defined in RFC 925.

For example:

```
-> arp 171.11.1.1 00:05:02:c0:7f:11 alias
```

- **ARP Name.** Use the **arp-name** parameter to specify a name for the permanent ARP entry.

For example:

```
-> arp 171.11.1.1 00:2a:90:d1:8e:10 arp-name server1
```

- **Interface.** Use the **interface** parameter to set the interface for ARP resolution.

For example:

```
-> arp 171.11.1.1 00:2a:90:d1:8e:10 arp-name server1 interface Int1
```

Use the **show arp** command to display the ARP table.

Note. As most hosts support the use of address resolution protocols to determine and cache address information (called dynamic address resolution), it is not required to specify permanent ARP entries.

Deleting a Permanent Entry from the ARP Table

Permanent entries do not age out of the ARP table. Use the **no arp** command to delete a permanent entry from the ARP table. When deleting an ARP entry, you only need to enter the IP address. For example, to delete an entry for IP address 171.11.1.1, you would enter:

```
-> no arp 171.11.1.1
```

Use the **show arp** command to display the ARP table and verify that the entry was deleted.

Note. You can also use the **no arp** command to delete a dynamic entry from the table.

Clearing a Dynamic Entry from the ARP Table

Dynamic entries can be cleared using the **clear arp-cache** command. This command clears all dynamic entries. Clear the permanent entries using the **no arp** command.

Use the **show arp** command to display the table and verify that the table was cleared.

Note. Dynamic entries remain in the ARP table until they time out. If the switch does not receive data from a host for this user-specified time, the entry is removed from the table. If another packet is received from this host, the switch goes through the discovery process again to add the entry to the table. The switch uses the MAC Address table time-out value as the ARP time-out value. Use the **mac-learning aging-time** command to set the time-out value.

Local Proxy ARP

The Local Proxy ARP feature is an extension of the Proxy ARP feature, but is enabled on an IP interface and applies to the VLAN bound to that interface. When Local Proxy ARP is enabled, all ARP requests received on VLAN member ports are answered with the MAC address of the IP interface that has Local Proxy ARP enabled. In essence, all VLAN traffic is now routed within the VLAN instead of bridged.

This feature is intended for use with port mapping applications where VLANs are one-port associations. This allows hosts on the port mapping device to communicate through the router. ARP packets are still bridged across multiple ports.

Local Proxy ARP takes precedence over any switch-wide Proxy ARP or ARP function. In addition, it is not necessary to configure Proxy ARP to use Local Proxy ARP. The two features are independent of each other.

By default, Local Proxy ARP is disabled when an IP interface is created. To enable this feature, use the **ip interface** command. For example:

```
-> ip interface Accounting local-proxy-arp
```

When Local Proxy ARP is enabled for any one IP router interface associated with a VLAN, the feature is applied to the entire VLAN. It is not necessary to enable it for each interface. However, if the IP interface that has the Local Proxy ARP feature enabled is moved to another VLAN, Local Proxy ARP is enabled for the new VLAN and must be enabled on another interface for the old VLAN.

ARP Filtering

ARP filtering is used to determine whether the switch responds to ARP requests that contain a specific IP address. ARP filtering is used in conjunction with the Local Proxy ARP application; however, it is available for use on its own or with other applications.

By default, no ARP filters exist in the switch configuration. When there are no filters present, all ARP packets are processed, unless they are blocked or redirected by some other feature.

Use the **arp filter** command to specify the following parameter values required to create an ARP filter:

- An IP address (for example, 193.204.173.21) used to determine whether an ARP packet is filtered.

- An IP mask (for example, 255.0.0.0) used to identify which part of the ARP packet IP address is compared to the filter IP address.
- An optional VLAN ID to specify that the filter is only applied to ARP packets from that VLAN.
- Which ARP packet IP address to use for filtering (sender or target). If the target IP address in the ARP packet matches a target IP specified in a filter, then the disposition for that filter applies to the ARP packet. If the sender IP address in the ARP packet matches a sender IP specified in a filter, then the disposition for that filter applies to the ARP packet.
- The filter disposition (block or allow). If an ARP packet meets filter criteria, the switch is either blocked from responding to the packet or allowed to respond to the packet depending on the filter disposition. Packets that do not meet any filter criteria are responded to by the switch.

The following **arp filter** command example creates an ARP filter, which blocks the switch from responding to ARP packets that contain a sender IP address that starts with 198:

```
-> arp filter 198.0.0.0 mask 255.0.0.0 sender block
```

Up to 200 ARP filters can be defined on a single switch. To remove an individual filter, use the no form of the **arp filter** command. For example:

```
-> no arp filter 198.0.0.0
```

To clear all ARP filters from the switch configuration, use the **clear arp filter** command. For example:

```
-> clear arp filter
```

Use the **show arp filter** command to verify the ARP filter configuration. For more information on ARP Filtering and other ARP filter commands, see the *OmniSwitch AOS Release 8 CLI Reference Guide*.

IP Configuration

IP is enabled on the switch by default and a few options that can, or need to be, configured. This section provides instructions for basic IP configuration options.

Configuring the Router Primary Address

By default, the router primary address is derived from the first IP interface that becomes operational on the router. If the router-id is not a valid IP unicast address, the router primary IP address is used by BGP to derive its unique BGP Identifier.

Use the **ip router primary-address** command to configure the router primary address. Enter the command, followed by the IP address. For example, to configure a router primary address of 172.22.2.115, you must enter:

```
-> ip router primary-address 172.22.2.115
```

Configuring the Router ID

By default, the primary address of the router is used as the router ID. However, if a primary address has not been explicitly configured, the router ID defaults to the address of the first IP interface that becomes operational.

Use the **ip router router-id** command to configure the router ID. Enter the command, followed by the IP address. For example, to configure a router ID of 172.22.2.115, you would enter:

```
-> ip router router-id 172.22.2.115
```

Configuring the Route Preference of a Router

By default, the route preference of a router is in this order: local, static, OSPF, RIP, EBGp, and IBGP (highest to lowest).

Use the **ip route-pref** command to change the route preference value of a router. For example, to configure the route preference of an OSPF route, you would enter:

```
-> ip route-pref ospf 15
```

To display the current route preference configuration, use the **show ip route-pref** command:

```
-> show ip route-pref
  Protocol      Route Preference Value
-----+-----
  Local                1
  Static              2
  OSPF                110
  RIP                 120
  EBGp                190
  IBGP                200
```

Configuring the Time-to-Live (TTL) Value

The TTL value is the default value inserted into the TTL field of the IP header of datagrams originating from the switch whenever a TTL value is not supplied by the transport layer protocol. The value is measured in hops.

Use the **ip default-ttl** command to set the TTL value. Enter the command, followed by the TTL value. For example, to set a TTL value of 75, you must enter:

```
-> ip default-ttl 75
```

The default hop count is 64. The valid range is 1 to 255. Use the **show ip config** command to display the default TTL value.

Configuring Route Map Redistribution

You can learn and advertise IPv4 routes between different protocols. Such a process is referred to as route redistribution and is configured using the **ip service source-ip** command.

Redistribution uses route maps to control how external routes are learned and distributed. A route map consists of one or more user-defined statements that can determine which routes are allowed or denied access to the receiving network. In addition, a route map can also contain statements that modify route parameters before they are redistributed.

When a route map is created, a name is given to identify the group of statements that it represents. This name is required by the **ip redistrib** command. Therefore, configuring route redistribution involves the following steps:

- 1 Create a route map, as described in [“Using Route Maps” on page 16-18](#).
- 2 Configure redistribution to apply a route map, as described in [“Configuring Route Map Redistribution” on page 16-22](#).

Using Route Maps

A route map specifies the criteria that are used to control redistribution of routes between protocols. Such criteria is defined by configuring route map statements. There are three different types of statements:

- **Action.** An action statement configures the route map name, sequence number, and whether redistribution is permitted or denied based on route map criteria.
- **Match.** A match statement specifies criteria that a route must match. When a match occurs, then the action statement is applied to the route.
- **Set.** A set statement is used to modify route information before the route is redistributed into the receiving protocol. This statement is only applied if all the criteria of the route map is met and the action permits redistribution.

The **ip route-map** command is used to configure route map statements and provides the following **action**, **match**, and **set** parameters:

ip route-map action ...	ip route-map match ...	ip route-map set ...
permit	ip-address	metric
deny	ip-nexthop	metric-type
	ipv6-address	tag
	ipv6-nexthop	community
	tag	local-preference
	ipv4-interface	level
	ipv6-interface	ip-nexthop
	metric	ipv6-nexthop
	route-type	

Refer to the “IP Commands” chapter in the *OmniSwitch AOS Release 8 CLI Reference Guide* for more information about the **ip route-map** command parameters and usage guidelines.

Once a route map is created, it is then applied using the **ip service source-ip** command. See “[Configuring Route Map Redistribution](#)” on page 16-22 for more information.

Route Maps are also used for VRF route leaking and RIP route filtering. See “[VRF Route Leak](#)” on page 16-38 section for more information.

Creating a Route Map

When a route map is created, a name (up to 20 characters), a sequence number, and an action (permit or deny) is specified. Specifying a sequence number is optional. If a value is not configured, then the number 50 is used by default.

To create a route map, use the **ip route-map** command with the **action** parameter. For example,

```
-> ip route-map ospf-to-bgp sequence-number 10 action permit
```

The above command creates the ospf-to-bgp route map, assigns a **sequence number** of 10 to the route map, and specifies a **permit** action.

To optionally filter routes before redistribution, use the **ip route-map** command with a **match** parameter to configure match criteria for incoming routes. For example,

```
-> ip route-map ospf-to-bgp sequence-number 10 match tag 8
```

The above command configures a match statement for the ospf-to-bgp route map to filter routes based on their tag value. When this route map is applied, only OSPF routes with a tag value of eight are redistributed into the BGP network. All other routes with a different tag value are dropped.

Note. Configuring match statements is not required. However, if a route map does not contain any match statements and the route map is applied using the **ip service source-ip** command, the router redistributes *all* routes into the network of the receiving protocol.

Use the **ip route-map** command with a **set** parameter to modify route information before redistribution. For example,

```
-> ip route-map ospf-to-bgp sequence-number 10 set tag 5
```

The above command configures a set statement for the ospf-to-bgp route map that changes the route tag value to five. As this statement is part of the ospf-to-bgp route map, it is only applied to routes that have an existing tag value equal to eight.

The following is a summary of the commands used in the above examples:

```
-> ip route-map ospf-to-bgp sequence-number 10 action permit
-> ip route-map ospf-to-bgp sequence-number 10 match tag 8
-> ip route-map ospf-to-bgp sequence-number 10 set tag 5
```

To verify a route map configuration, use the **show ip route-map** command:

```
-> show ip route-map
Route Maps: configured: 1 max: 200
Route Map: ospf-to-bgp Sequence Number: 10 Action permit
        match tag 8
        set tag 5
```

Deleting a Route Map

Use the **no** form of the **ip route-map** command to delete an entire route map, a route map sequence, or a specific statement within a sequence.

To delete an entire route map, enter **no ip route-map** followed by the route map name. For example, the following command deletes the entire route map named `redistipv4`:

```
-> no ip route-map redistipv4
```

To delete a specific sequence number within a route map, enter **no ip route-map** followed by the route map name, then **sequence-number** followed by the actual number. For example, the following command deletes sequence 10 from the `redistipv4` route map:

```
-> no ip route-map redistipv4 sequence-number 10
```

In the above example, the `redistipv4` route map is not deleted. Only those statements associated with sequence 10 are removed from the route map.

To delete a specific statement within a route map, enter **no ip route-map** followed by the route map name, then **sequence-number** followed by the sequence number for the statement, then either **match** or **set** and the match or set parameter and value. For example, the following command deletes only the `match tag 8` statement from route map `redistipv4` sequence 10:

```
-> no ip route-map redistipv4 sequence-number 10 match tag 8
```

Configuring Route Map Sequences

A route map can consist of one or more sequences of statements. The sequence number determines which statements belong to which sequence and the order in which sequences for the same route map are processed.

To add match and set statements to an existing route map sequence, specify the same route map name and sequence number for each statement. For example, the following series of commands creates route map `rm_1` and configures match and set statements for the `rm_1` sequence 10:

```
-> ip route-map rm_1 sequence-number 10 action permit
-> ip route-map rm_1 sequence-number 10 match tag 8
-> ip route-map rm_1 sequence-number 10 set metric 1
```

To configure a new sequence of statements for an existing route map, specify the same route map name but use a different sequence number. For example, the following commands create a sequence 20 for the `rm_1` route map:

```
-> ip route-map rm_1 sequence-number 20 action permit
```



```
-> ip route-map rm_1 sequence-number 20 match ipv4-interface to-finance
-> ip route-map rm_1 sequence-number 20 set metric 5
```

The resulting route map appears as follows:

```
-> show ip route-map rm_1
Route Map: rm_1 Sequence Number: 10 Action permit
  match tag 8
  set metric 1
Route Map: rm_1 Sequence Number: 20 Action permit
  match ip4 interface to-finance
  set metric 5
```

Sequence 10 and sequence 20 are both linked to route map `rm_1` and are processed in ascending order according to their sequence number value. There is an implied logical OR between sequences. As a result, if there is no match for the tag value in sequence 10, then the match interface statement in sequence 20 is processed. However, if a route matches the tag 8 value, then sequence 20 is not used. The set statement for whichever sequence was matched is applied.

A route map sequence can contain multiple match statements. If these statements are of the same kind (for example, match tag 5, match tag 8, and so on) then a logical OR is implied between each like statement. If the match statements specify different types of matches (for example, match tag 5, match ip4 interface to-finance, and so on), then a logical AND is implied between each statement. For example, the following route map sequence redistributes a route if its tag is either 8 or 5:

```
-> ip route-map rm_1 sequence-number 10 action permit
-> ip route-map rm_1 sequence-number 10 match tag 5
-> ip route-map rm_1 sequence-number 10 match tag 8
```

If the route has a tag of 8 or 5 and the route was learned on the IPv4 interface to-finance, the following route map sequence redistributes a route:

```
-> ip route-map rm_1 sequence-number 10 action permit
-> ip route-map rm_1 sequence-number 10 match tag 5
-> ip route-map rm_1 sequence-number 10 match tag 8
-> ip route-map rm_1 sequence-number 10 match ipv4-interface to-finance
```

Configuring Access Lists

An IP access list provides a convenient way to add multiple IPv4 or IPv6 addresses to a route map. Using an access list avoids having to enter a separate route map statement for each individual IP address. Instead, a single statement is used that specifies the access list name. The route map is then applied to all the addresses contained within the access list.

Configuring an IP access list involves two steps: creating the access list and adding IP addresses to the list. To create an IP access list, use the **ip access-list** command (IPv4) or the **ipv6 access-list** command (IPv6) and specify a name to associate with the list. For example,

```
-> ip access-list ipaddr
-> ipv6 access-list ip6addr
```

To add addresses to an access list, use the **ip access-list address** (IPv4) or the **ipv6 access-list address** (IPv6) command. For example, the following commands add addresses to an existing access list:

```
-> ip access-list ipaddr address 10.0.0.0/8
-> ipv6 access-list ip6addr address 2001::/64
```

Use the same access list name each time the above commands are used to add additional addresses to the same access list. In addition, both commands provide the ability to configure if an address and/or its matching subnet routes are permitted (the default) or denied redistribution. For example:

```
-> ip access-list ipaddr address 16.24.2.1/16 action deny redist-control all-
subnets
-> ipv6 access-list ip6addr address 2001::1/64 action permit redist-control no-
subnets
```

For more information about configuring access list commands, see the “IP Commands” chapter in the *OmniSwitch AOS Release 8 CLI Reference Guide*.

Configuring Route Map Redistribution

The **ip service source-ip** command is used to configure the redistribution of routes from a source protocol into the destination protocol. This command is used on the IPv4 router that performs the redistribution.

A source protocol is a protocol from which the routes are learned. A destination protocol is the one into which the routes are redistributed. Ensure that both protocols are loaded and enabled before configuring redistribution.

Redistribution applies criteria specified in a route map to routes received from the source protocol. Therefore, configuring redistribution requires an existing route map. For example, the following command configures the redistribution of OSPF routes into a BGP network using the `ospf-to-bgp` route map:

```
-> ip redist ospf into bgp route-map ospf-to-bgp
```

OSPF routes received by the router interface are processed based on the contents of the `ospf-to-bgp` route map. Routes that match criteria specified in this route map are either allowed or denied redistribution into the BGP network. The route map can also specify the modification of route information before the route is redistributed. See “Using Route Maps” on page 16-18 for more information.

To remove a route map redistribution configuration, use the **no** form of the **ip redist** command. For example:

```
-> no ip redist ospf into bgp route-map ospf-to-bgp
```

Use the **show ip redist** command to verify the redistribution configuration:

```
-> show ip redist
```

Source Protocol	Destination Protocol	Status	Route Map
LOCAL4	RIP	Enabled	rip_1
LOCAL4	OSPF	Enabled	ospf_2
LOCAL4	BGP	Enabled	bgp_3
RIP	OSPF	Enabled	ospf-to-bgp

Configuring the Administrative Status of the Route Map Redistribution

The administrative status of a route map redistribution configuration is enabled by default. To change the administrative status, use the **status** parameter with the **ip redist** command. For example, the following command disables the redistribution administrative status for the specified route map:

```
-> ip redist ospf into bgp route-map ospf-to-bgp status disable
```

The following command example enables the administrative status:

```
-> ip redist ospf into bgp route-map ospf-to-bgp status enable
```

Route Map Redistribution Example

The following example configures the redistribution of OSPF routes into a BGP network using a route map (ospf-to-bgp) to filter specific routes:

```
-> ip route-map ospf-to-bgp sequence-number 10 action deny
-> ip route-map ospf-to-bgp sequence-number 10 match tag 5
-> ip route-map ospf-to-bgp sequence-number 10 match route-type external type2

-> ip route-map ospf-to-bgp sequence-number 20 action permit
-> ip route-map ospf-to-bgp sequence-number 20 match ipv4-interface intf_ospf
-> ip route-map ospf-to-bgp sequence-number 20 set metric 255

-> ip route-map ospf-to-bgp sequence-number 30 action permit
-> ip route-map ospf-to-bgp sequence-number 30 set tag 8

-> ip redist ospf into bgp route-map ospf-to-bgp
```

The resulting ospf-to-bgp route map redistribution configuration does the following

- Denies the redistribution of Type 2 external OSPF routes with a tag set to five.
- Redistributes into BGP all routes learned on the intf_ospf interface and sets the metric for such routes to 255.
- Redistributes into BGP all other routes that are not processed by sequence 10 or 20, and sets the tag for such routes to eight.

IP-Directed Broadcasts

An IP directed broadcast is an IP datagram that has all zeros or all 1 in the host portion of the destination IP address. The packet is sent to the broadcast address of a subnet to which the sender is not directly attached. Directed broadcasts are used in denial-of-service “smurf” attacks. In a smurf attack, a continuous stream of ping requests is sent from a falsified source address to a directed broadcast address, resulting in a large stream of replies, which can overload the host of the source address. By default, the switch drops directed broadcasts. Directed broadcasts must not be enabled.

Use the **ip directed-broadcast** command to enable or disable IP-directed broadcasts. For example:

```
-> ip directed-broadcast enable
```

Use the **show ip config** command to display the IP-directed broadcast state.

Denial of Service (DoS) Filtering

By default, the switch filters denial of service (DoS) attacks, which are security attacks aimed at devices that are available on a private network or the Internet. Few attacks aim at system bugs or vulnerability (for example, teardrop attacks), while other types of attacks involve generating large volumes of traffic so that network service is denied to legitimate network users (such as pepsi attacks). These attacks include the following:

- **ICMP Ping of Death**—Ping packets that exceed the largest IP datagram size (65535 bytes) are sent to a host and crash the system.
- **SYN Attack**—Floods a system with a series of TCP SYN packets, resulting in the host issuing SYN-ACK responses. The half open TCP connections can exhaust TCP resources, such that no other TCP connections are accepted.
- **Land Attack**—Spoofed packets are sent with the SYN flag set to a host on any open port that is listening. The machine can crash or reboot in an attempt to respond.
- **Pepsi Attack**—The most common form of UDP flooding directed at harming networks. A pepsi attack is an attack consisting of a large number of spoofed UDP packets aimed at diagnostic ports on network devices. A pepsi attack can cause network devices to use up a large amount of CPU time responding to these packets.
- **ARP Flood Attack**—Floods a switch with a large number of ARP requests, resulting in the switch using a large amount of the CPU time to respond to these requests. If the number of ARP requests exceeds the preset value of 500 per second, an attack is detected.
- **Invalid IP Attack**—Packets with invalid source or destination IP addresses are received by the switch. When such an Invalid-IP attack is detected, the packets are dropped, and SNMP traps are generated. Following are few examples of invalid source and destination IP addresses:

Invalid Source IP address	<ul style="list-style-type: none">• 0.x.x.x.• 255.255.255.255.• subnet broadcast, that is, 172.28.255.255, for an existing IP interface 172.28.0.0/16.• in the range 224.x.x.x - 255.255.255.254.• Source IP address equals one of Switch IP Interface addresses.
---------------------------	---

Invalid Destination IP address	<ul style="list-style-type: none"> • 127.x.x.x. • in the range 240.x.x.x - 255.255.255.254. • 0.0.0.0 (valid exceptions- certain DHCP packets). • 172.28.0.0 for a router network 172.28.4.11/16. • 0.x.x.x.
--------------------------------	---

- **Multicast IP and MAC Address Mismatch**—This attack is detected when:
 - the source MAC address of a packet received by a switch is a Multicast MAC address.
 - the destination IP and MAC addresses of a packet received by a switch is same as the Multicast IP and MAC addresses, but the Multicast IP and the Multicast MAC addresses do not match.

Note. In both the conditions described above in “Multicast IP and MAC Address Mismatch”, packets are dropped and SNMP traps are generated.

- the destination IP is a unicast IP and the destination MAC address is either a Broadcast or Multicast address. In such a condition, an event is recorded in the DoS statistics. No SNMP traps are generated as valid packets can also fall under this category.
- **Ping overload**—Floods a switch with a large number of ICMP packets, resulting in the switch using a large amount of CPU time to respond to these packets. If the number of ICMP packets exceed 100 per second, a DoS attack is detected. By default, the detection of attack is disabled.
- **Packets with loopback source IP address**—Packets with an invalid source address of 127.0.0.0/8 (loopback network) are received by the switch. When such packets are detected, they are dropped, and SNMP traps are generated.

The switch can be set to detect various types of port scans by monitoring for TCP or UDP packets sent to open or closed ports. Monitoring is done in the following manner:

- **Packet penalty values set.** TCP and UDP packets destined for open or closed ports are assigned a penalty value. Each time a packet of this type is received, its assigned penalty value is added to a running total. This total is cumulative and includes all TCP and UDP packets destined for open or closed ports.
- **Port scan penalty value threshold.** The switch is given a port scan penalty value threshold. This number is the maximum value the running penalty total can achieve before triggering an SNMP trap.
- **Decay value.** A decay value is set. The running penalty total is divided by the decay value every minute.
- **Trap generation.** If the total penalty value exceeds the set port scan penalty value threshold, a trap is generated to alert the administrator that a port scan can be in progress.

For example, imagine that a switch is set so that TCP and UDP packets destined for closed ports are given a penalty of 10, TCP packets destined for open ports are given a penalty of 5, and UDP packets destined for open ports are given a penalty of 20. The decay is set to 2, and the switch port scan penalty value threshold is set to 2000:

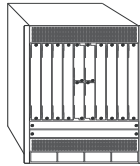
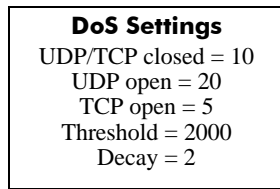

Penalty Total = 0

In 1 minute, 10 TCP closed port packets and 10 UDP closed port packets are received. This brings the total penalty value to 200, as shown using the following equation:

$$(10 \text{ TCP} \times 10 \text{ penalty}) + (10 \text{ UDP} \times 10 \text{ penalty}) = 200$$

This value would be divided by 2 (due to the decay) and decreased to 100. The switch would not record a port scan:

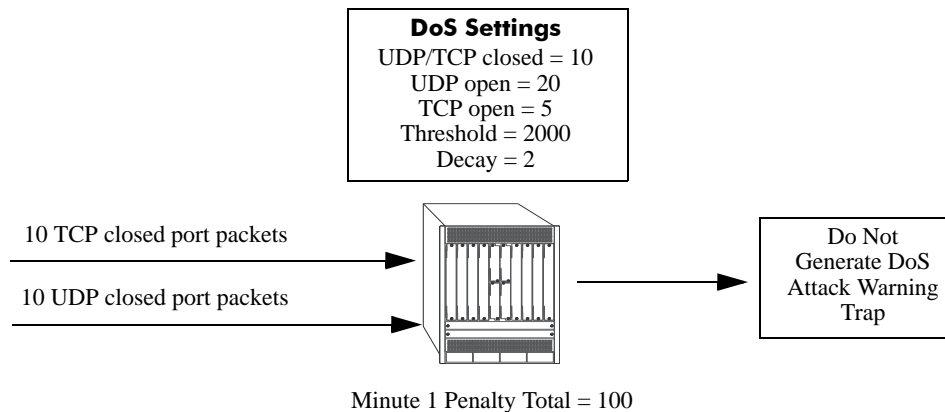

In the next minute, 10 more TCP and UDP closed port packets are received, along with 200 UDP open port packets. This would bring the total penalty value to 4300, as shown using the following equation:

$$(100 \text{ previous minute value}) + (10 \text{ TCP} \times 10 \text{ penalty}) + (10 \text{ UDP} \times 10 \text{ penalty}) + (200 \text{ UDP} \times 20 \text{ penalty}) = 4300$$

This value would be divided by 2 (due to decay) and decreased to 2150. The switch would record a port scan and generate a trap to warn the administrator:

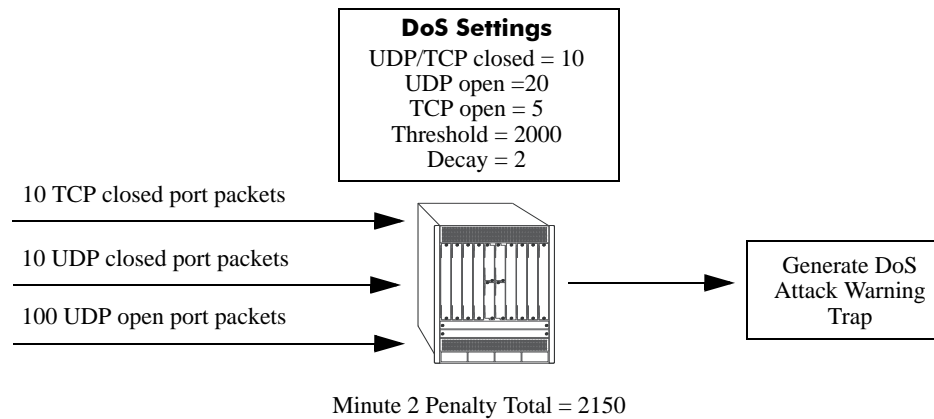

The above functions and how to set their values are covered in the sections that follow.

Setting Penalty Values

You can set a penalty value for the following types of traffic:

- TCP/UDP packets bound for closed ports.
- TCP traffic bound for open ports.
- UDP traffic bound for open ports.

Each type has its own command to assign a penalty value. Penalty values can be any non-negative integer. Each time a packet is received that matches an assigned penalty, the total penalty value for the switch is increased by the penalty value of the packet in question.

To assign a penalty value to TCP/UDP packets bound for a closed port, use the **ip dos scan close-port-penalty** command with a penalty value. For example, to assign a penalty value of 10 to TCP/UDP packets destined for closed ports, enter the following:

```
-> ip dos scan close-port-penalty 10
```

To assign a penalty value to TCP packets bound for an open port, use the **ip dos scan tcp open-port-penalty** command with a penalty value. For example, to assign a penalty value of 10 to TCP packets destined for opened ports, enter the following:

```
-> ip dos scan tcp open-port-penalty 10
```

To assign a penalty value to UDP packets bound for an open port, use the **ip dos scan udp open-port-penalty** command with a penalty value. For example, to assign a penalty value of 10 to TCP/UDP packets destined for closed ports, enter the following:

```
-> ip dos scan udp open-port-penalty 10
```

Setting the Port Scan Penalty Value Threshold

The port scan penalty value threshold is the highest point the total penalty value for the switch can reach before a trap is generated informing the administrator that a port scan is in progress.

To set the port scan penalty value threshold, enter the threshold value with the **ip dos scan threshold** command. For example, to set the port scan penalty value threshold to 2000, enter the following:

```
-> ip dos scan threshold 2000
```

Setting the Decay Value

The decay value is the amount the total penalty value is divided by every minute. As the switch records incoming UDP and TCP packets, it adds their assigned penalty values together to create the total penalty value for the switch. To prevent the switch from registering a port scan from normal traffic, the decay value is set to lower the total penalty value every minute to compensate from normal traffic flow.

To set the decay value, enter the decay value with the **ip dos scan decay** command. For example, to set the decay value to 2, enter the following:

```
-> ip dos scan decay 2
```

Enabling DoS Traps

Enable the DoS traps for the switch to warn the administrator that a port scan can be in progress when the total penalty value of the switch crosses the port scan penalty value threshold.

To enable SNMP trap generation, enter the **ip dos trap** command, as shown:

```
-> ip dos trap enable
```

To disable DoS traps, enter the same **ip dos trap** command, as shown:

```
-> ip dos trap disable
```

ARP Poisoning

ARP Poisoning allows an attacker to sniff and tamper the data frames on a network. It also modifies or halts the traffic. The principle of ARP Poisoning is to send false or spoofed ARP messages to an Ethernet LAN.

Alcatel-Lucent introduces the functionality that detects the presence of an ARP poisoning host on a network. This functionality uses a configured restricted IP addresses, so that the switch does not get ARP response on sending an ARP request. If an ARP response is received, then an event is logged and the user is alerted using an SNMP trap.

Use the **ip dos arp-poison restricted-address** command to add an ARP Poison restricted address. Enter the command, followed by the IP address. For example, to add an ARP Poison restricted address as 192.168.1.1, you would enter:

```
-> ip dos arp-poison restricted-address 192.168.1.1
```

To delete an ARP Poison restricted address, enter **no ip dos arp-poison restricted-address** followed by the IP address. For example:

```
-> no ip dos arp-poison restricted-address 192.168.1.1
```

To verify the number of attacks detected for configured ARP poison restricted addresses, use the **show ip service source-ip** command. For more information about this command, see the *OmniSwitch AOS Release 8 CLI Reference Guide*.

Enabling/Disabling IP Services

When a switch initially boots up, all supported TCP/UDP well-known service ports are enabled (open). Although these ports provide access for essential switch management services, such as telnet, FTP, SNMP, they also are vulnerable to DoS attacks. It is possible to scan open service ports and launch such attacks based on well-known port information.

The **ip service** command allows you to disable (close) TCP/UDP well-known service ports selectively and enable them when necessary. This command only operates on TCP/UDP ports that are opened by default. It has no impact on ports that are opened by loading applications, such as RIP and BGP.

In addition, the **ip service** command allows you to designate which service to enable or disable by specifying the name of a service as well as changing the well-known port number associated with that service. For example, the following commands disable the telnet service, change the port and re-enable the service:

```
-> ip service telnet admin-state disable
-> ip service telnet port 20999
-> ip service telnet admin-state enable
```

Use **default** parameter to revert the port number of a service to the default port number.

```
-> ip service telnet port default
```

The following table lists **ip service** command options for specifying TCP/UDP services and also includes the well-known port number associated with each service:

service	port
ftp	21
ssh	22
telnet	23
http	80
https	443
network-time	123
snmp	161

Managing IP

The following sections describe IP commands that can be used to monitor and troubleshoot IP forwarding on the switch.

Internet Control Message Protocol (ICMP)

Internet Control Message Protocol (ICMP) is a network layer protocol within the IP protocol suite that provides message packets to report errors and other IP packet processing information back to the source. ICMP generates various kinds of useful messages, including Destination Unreachable, Echo Request and Reply, Redirect, Time Exceeded, and Router Advertisement and Solicitation. If an ICMP message cannot be delivered, a second one is not generated thus preventing an endless flood of ICMP messages.

When an ICMP destination-unreachable message is sent by a switch, it means that the switch is unable to send the package to its final destination. The switch then discards the original packet. There are two reasons why a destination is not reachable. Most commonly, the source host has specified a non-existent address. Less frequently, the switch does not have a route to the destination. The destination-unreachable messages include four basic types:

- **Network-Unreachable Message**—Usually means that a failure has occurred in the route lookup of the destination IP in the packet.
- **Host-Unreachable Message**—Usually indicates delivery failure, such as an unresolved client's hardware address or an incorrect subnet mask.
- **Protocol-Unreachable Message**—Usually means that the destination does not support the upper-layer protocol specified in the packet.
- **Port-Unreachable Message**—Implies that the TCP/UDP socket or port is not available.

Additional ICMP messages include:

- **Echo-Request Message**—Generated by the ping command, the message is sent by any host to test node reachability across an internetwork. The ICMP echo-reply message indicates that the node can be successfully reached.
- **Redirect Message**—Sent by the switch to the source host to stimulate more efficient routing. The switch still forwards the original packet to the destination. ICMP redirect messages allow host routing tables to remain small because it is necessary to know the address of only one switch, even if that switch does not provide the best path. Even after receiving an ICMP redirect message, few devices continue using the less-efficient route.
- **Time-Exceeded Message**—Sent by the switch if an IP packet's TTL field reaches zero. If the internetwork contains a routing loop, the TTL field prevents packets from continuously circulating the internetwork. Once a packet TTL field reaches 0, the switch discards the packet.

Activating ICMP Control Messages

ICMP messages are identified by a *type* and a *code*. This number pair specifies an ICMP message. For example, ICMP type 4, code 0, specifies the source quench ICMP message.

To enable or disable an ICMP message, use the **icmp type** command with the type and code. For example, to enable the source quench the ICMP message (type 4, code 0) enter the following:

```
-> icmp type 4 code 0 enable
```

To list the ICMP message information use the **show icmp control** command.

In addition to the **icmp type** command, many commonly used ICMP messages have separate CLI commands for convenience. The following table lists the ICMP message name, type, and code:

ICMP Message	Command
Network unreachable (type 0, code 3)	icmp unreachable
Host unreachable (type 3, code 1)	icmp unreachable
Protocol unreachable (type 3, code 2)	icmp unreachable
Port unreachable (type 3, code 3)	icmp unreachable
Echo reply (type 0, code 0)	icmp echo
Echo request (type 8, code 0)	icmp echo
Timestamp request (type 13, code 0)	icmp timestamp
Timestamp reply (type 14, code 0)	icmp timestamp
Address Mask request (type 17, code 0)	icmp addr-mask
Address Mask reply (type 18, code 0)	icmp addr-mask

These commands are entered as the **icmp type** command, only without specifying a type or code. The echo, timestamp, and address mask commands have options for distinguishing between a request or a reply, and the unreachable command has options distinguishing between a network, host, protocol, or port.

For example, to enable an echo request message, enter the following:

```
-> icmp echo request enable
```

To enable a network unreachable message, enter the following:

```
-> icmp unreachable net-unreachable enable
```

Note. Enabling **host-unreachable** and **net-unreachable** messages are not recommended as it can cause the switch instability due to high-CPU conditions depending upon the volume of traffic required by these messages.

See [Chapter 16, “IP Commands,”](#) for specifics on the ICMP message commands.

Enabling All ICMP Types

To enable all ICMP message types, use the **icmp messages** command with the **enable** keyword. For example:

```
-> icmp messages enable
```

To disable all ICMP messages, enter the same command with the **disable** keyword. For example:

```
-> icmp messages enable
```

Setting the Minimum Packet Gap

The minimum packet gap is the time required between sending messages of a like type. For instance, if the minimum packet gap for Address Mask request messages is 40 microseconds, and an Address Mask message is sent, at least 40 microseconds must pass before another one could be sent.

To set the minimum packet gap, use the **min-pkt-gap** keyword with any of the ICMP control commands. For example, to set the Source Quench minimum packet gap to 100 microseconds, enter the following:

```
-> icmp type 4 code 0 min-pkt-gap 100
```

Likewise, to set the Timestamp Reply minimum packet gap to 100 microseconds, enter the following:

```
-> icmp timestamp reply min-pkt-gap 100
```

ICMP Control Table

The ICMP Control Table displays the ICMP control messages, whether they are enabled or disabled, and the minimum packet gap times. Use the **show icmp control** command to display the table.

ICMP Statistics Table

The ICMP Statistics Table displays the ICMP statistics and errors. This data can be used to monitor and troubleshoot IP on the switch. Use the **show icmp statistics** command to display the table.

Using the Ping Command

The **ping** command is used to test whether an IP destination can be reached from the local switch. This command sends an ICMP echo request to a destination and then waits for a reply. To ping a destination, enter the **ping** command and enter either the IP address of the destination or the host name. The switch pings the destination by using the default frame count, packet size, interval, and time-out parameters (6 frames, 64 bytes, 1 second, and 5 seconds, respectively). For example:

```
-> ping 172.22.2.115
```

When you ping a device, the device IP address or host name is required. Optionally, you can also specify:

- **Count.** Use the **count** keyword to set the number of frames to be transmitted.
- **Size.** Use the **size** keyword to set the size, in bytes, of the data portion of the packet sent for this ping. You can specify a size or a range of sizes up to 60000.
- **Interval.** Use the **interval** keyword to set the frequency, in seconds, that the switch polls the host.
- **Time-out.** Use the **time-out** keyword to set the number of seconds the program waits for a response before timing out.

- **source-interface.** Use the **source-interface** keyword to set the IP address to be used as source IP for the ping packets.
- **data-pattern.** Use the **data-pattern** keyword to set the data pattern to be used in the data field of the ping packets.
- **dont-fragment.** Use the **dont-fragment** keyword to set the don't-fragment bit in the IP packet.
- **tos.** Use the **tos** keyword to set the type of service field in the IP header.

For example, to send a ping with a count of 2, a size of 32 bytes, an interval of 2 seconds, time-out of 10 seconds, a source-interface using mgmt, tos of 1, data-pattern of AB and dont-fragment you would enter:

```
-> ping 172.22.2.115 count 2 size 32 interval 2 timeout 10 source-interface mgmt
tos 1 data-pattern AB dont-fragment
```

Note. If you change the default values, they only apply to the current ping. The next time you use the **ping** command, the default values are used unless you enter different values again.

Tracing an IP Route

The **traceroute** command is used to find the path taken by an IP packet from the local switch to a specified destination. This command displays the individual hops to the destination as well as timing information. When using this command, enter the name of the destination as part of the command line (either the IP address or host name). Use the optional **max-hop** parameter to set a maximum hop count to the destination. If the trace reaches this maximum hop count without reaching the destination, the trace stops.

For example, to perform a traceroute to a device with an IP address of 172.22.2.115 with a maximum hop count of 10 you would enter:

```
-> traceroute 172.22.2.115 max-hop 10
```

Optionally, you can also specify:

- **min-hop.** Use the **min-hop** keyword to set the minimum number of hops for the first packet.
- **source-interface.** Use the **source-interface** keyword to set the source IP interface to be used in the traceroute packets.
- **probes.** Use the **probes** keyword to set the number of packets (retry) to be sent for each hop-count.
- **timeout.** Use the **timeout** keyword to set the time to wait for the response of each probe packet.
- **port.** Use the **port** keyword to set the destination port number to be used in the probing packets.

Displaying TCP Information

Use the **show tcp statistics** command to display TCP statistics. Use the **show tcp ports** command to display TCP port information.

Displaying UDP Information

UDP is a secondary transport-layer protocol that uses IP for delivery. UDP is not connection-oriented and does not provide reliable end-to-end delivery of datagrams. Few applications can safely use UDP to send datagrams that do not require the extra overhead added by TCP. Use the **show udp statistics** command to display UDP statistics. Use the **show udp ports** command to display UDP port information.

Tunneling

Tunneling is a mechanism that can encapsulate a wide variety of protocol packet types and route them through the configured tunnels. Tunneling is used to create a virtual point-to-point link between routers at remote points in a network. This feature supports the creation, administration, and deletion of IP interfaces whose underlying virtual device is a tunnel. The Alcatel-Lucent implementation provides support for two tunneling protocols: Generic Routing Encapsulation (GRE) and IP encapsulation within IP (IPIP).

Generic Routing Encapsulation

GRE encapsulates a packet to be carried over the GRE tunnel with a GRE header. The resulting packet is then encapsulated with an outer header by the delivery protocol and forwarded to the other end of the GRE tunnel. The destination IP address field in the outer header of the GRE packet contains the IP address of the router at the remote end of the tunnel. The router at the receiving end of the GRE tunnel extracts the original payload and routes it to the destination address specified in the IP header of the payload.

Note. A switch can support up to 127 GRE tunnel interfaces.

IP Encapsulation within IP

IPIP tunneling is a method by which an IP packet is encapsulated within another IP packet. The Source Address and Destination Address of the outer IP header identifies the endpoints of tunnel. Whereas Source Address and Destination Address of the inner IP header identifies the original sender and recipient of the packet, respectively.

Consider the following when configuring the IPIP tunnel interfaces:

- A switch can support up to 127 IPIP tunnel interfaces.
- IPIP tunnel interfaces are included in the maximum number of IP interfaces that are supported on the switch.

Tunneling operation

The following diagram illustrates how packets are forwarded over the tunnel.

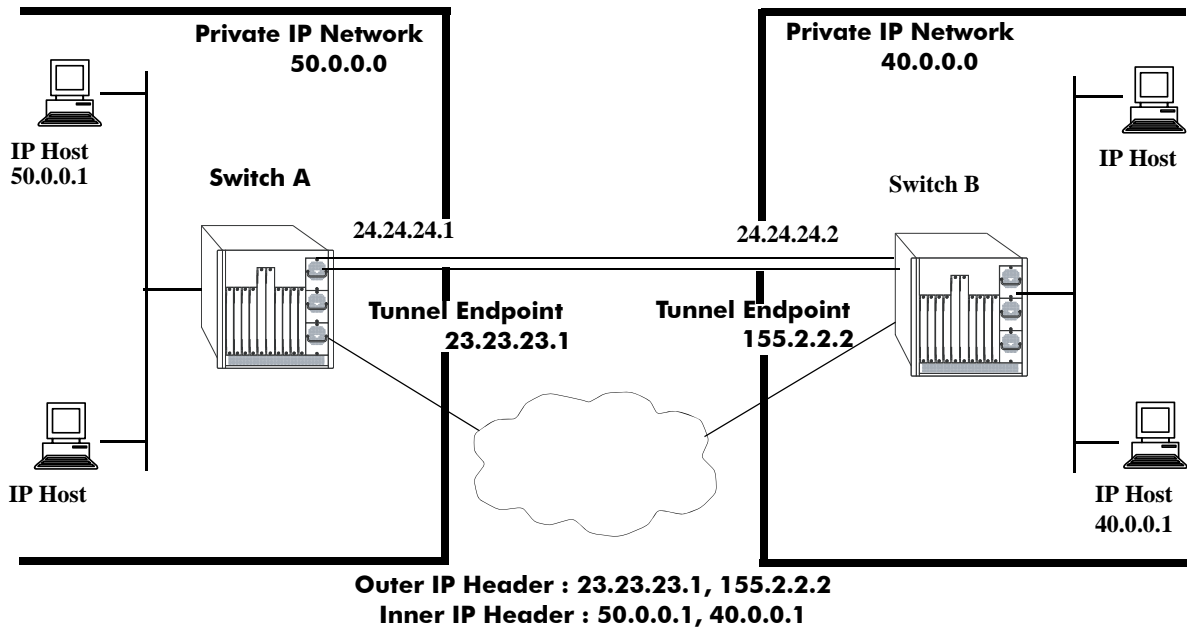

In the given diagram, IP packets flowing from the private IP network 50.0.0.0 to the private IP network 40.0.0.0 are encapsulated by the tunneling protocol at switch A and forwarded to switch B. Intermediate switches route the packets using addresses in the delivery protocol header. Switch B extracts the original payload and routes it to the appropriate destination in the 40.0.0.0 network.

The tunnel interface is identified as being up when all of the following are satisfied:

- Both source and destination addresses are assigned.
- The source address of the tunnel is one of the switch's IP interface addresses that is either a VLAN or Loopback0 interface.
- A route is available to reach the destination IP address. A route whose egress interface is a VLAN-based interface is available for its destination IP address. The switch supports assigning an IP address as well as routes to a tunnel interface.

This section describes how to configure a tunnel interface using GRE and IPIP, using Command Line Interface (CLI) commands.

Configuring a Tunnel Interface

To configure a GRE tunnel, use the **ip interface tunnel** command as shown:

```
-> ip interface "gre" tunnel source 23.23.23.1 destination 155.2.2.2 protocol gre
```

In this example, the GRE tunnel named “gre” is created and assigned a source IP address of 23.23.23.1 and a destination IP address of 155.2.2.2.

You can configure an IP address for the GRE tunnel interface using the **ip interface** command as shown:

```
-> ip interface "gre" address 24.24.24.1 mask 255.255.255.0
```

To configure an IPIP tunnel, use the **ip interface tunnel** command as shown:

```
-> ip interface "ipip" tunnel source 23.23.23.1 destination 155.2.2.2 protocol  
ipip
```

In this example, the IPIP tunnel named “ipip” is created and assigned a source IP address of 23.23.23.1 and a destination IP address of 155.2.2.2.

You can configure an IP address for the IPIP tunnel interface using the **ip interface** command as shown:

```
-> ip interface "ipip" address 24.24.24.1 mask 255.255.255.0
```

Notes.

- An interface can be configured only as a VLAN or a Tunnel interface.
 - To display information about the configured tunnels on the switch, use the **show ip interface**.
-

Verifying the IP Configuration

A summary of the show commands used for verifying the IP configuration is given here:

show ip interface	Displays the usability status of interfaces configured for IP.
show ip routes	Displays the IP Forwarding table.
show ip route-pref	Displays the configured route preference of a router.
show ip router database	Displays a list of all routes (static and dynamic) that exist in the IP router database.
show ip config	Displays IP configuration parameters.
show ip protocols	Displays switch routing protocol information and status.
show ip router-id	Displays the status of TCP/UDP service ports. Includes service name and well-known port number.
show arp	Displays the ARP table.
show arp filter	Displays the ARP filter configuration for the switch.
show icmp control	This command allows the viewing of the ICMP control settings.
show ip dos config	Displays the configuration parameters of the DoS scan for the switch.
show ip dos statistics	Displays the statistics on detected port scans for the switch.
show ip service source-ip	Displays the number of attacks detected for a restricted address.

For more information about the displays that result from these commands, see the *OmniSwitch AOS Release 8 CLI Reference Guide*.

VRF Route Leak

VRF provides isolation of routing instances from each other. The basic principle of VRF is to exclude two or more routing domains mutually by containing the exchange of routing information and forwarding packets within the same routing instance. VRF provides independent routing instances logically separating Layer3 topology of unrelated entities sharing a single physical infrastructure.

However, network devices in one VRF might need to access selected network devices in another VRF, such as in the following scenarios:

- In an enterprise, various departments can be isolated in individual VRFs but users in all the VRFs need access to the Mail Server/common enterprise portal.
- Users in other VRFs need internet access that is available in only one VRF.
- Buildings where multiple companies sharing the same router reside in individual VRFs have to access common services like logistics, common network equipment that is a part of an independent VRF.

VRF Route Leak feature can be used to forward routes from one VRF routing table to another VRF routing table, allowing routing from one VRF to a gateway in another VRF.

Quick Steps for Configuring VRF Route Leak

The following steps provide a quick tutorial on how to configure VRF Route Leak. Each step describes a specific operation and provides the CLI command syntax for performing that operation.

- 1 Create a route-map to use as a filter for exporting or importing routes.

```
-> ip route-map R1 action permit
```

- 2 Define protocol preference for export policy route map using the **ip route-map match** command. This route map controls the export of routes from the VRF FDB (Forwarding Routing Database) to the GRT (Global Routing Table). A route-map with no specific match clause matches all FDB routes. For example,

```
-> ip route-map R1 match protocol static
```

- 3 Export routes from the source VRF to the GRT using the **ip export** command. For example,

```
-> ip export route-map R1
```

- 4 Define protocol preference for import policy route map using the **ip route-map match** command. This route map controls the import of routes from the GRT. For example,

```
-> ip route-map R2 match protocol static
```

- 5 Import the leaked routes from the GRT using the **ip import** command. For example,

```
-> ip import vrf V1 import route-map R2
```

- 6 Configure route preference for imported routes using the **ip route-pref** command with the **import** parameter. For example,

```
-> ip route-pref import 100
```

- 7 Redistribute imported routes to other routing protocols that are imported and added to the RDB from other VRFs using the **ip service source-ip** command. For example,

```
-> ip redistrib import into ospf route-map R3 status enable
```

Configuring VRF Route Leak

This section describes how to configure VRF Route Leak using the CLI commands.

Export Routes to the GRT

Export routes from the source VRF to the Global Routing Table (GRT). Use route-map to filter routes. Only those FDB (Forwarding Routing Database) routes that match the conditions of the route map are exported to GRT.

If VRF is not configured, the routes are exported from the default VRF to GRT. Only one-route map can be configured as export policy in a VRF. Route leaking between VRFs only supports IPv4 routes.

To export routes from the default VRF, enter the **ip export** command at the CLI prompt as shown:

```
-> ip export route-map R1
```

To export routes from a specific VRF, specify the VRF globally or enter into the specific VRF instance and enter **ip export** command:

```
-> vrf vrf2 ip export route-map R1  
  
-> vrf vrf1  
vrf1::-> ip export route-map R1
```

Note. As a pre-requisite to export routes, create a route-map and define protocol preference for the route map by using **ip route-map** and **ip route-map match** commands. Route map configured for an export policy can contain any of the following filter and set options:

- Filter options: ip-address, ip-next-hop, tag, protocol, ipv4-interface, metric, route-type
- Set option: tag, metric

For route map configuration and match extensions, see [“Using Route Maps” on page 16-18](#).

To disable exporting of routes from the VRF to the GRT, use the **no** form of this command as shown:

```
-> no ip export R1
```

Import Routes from the GRT

Import routes from GRT to the destination VRF. Use route-map to filter imported routes. Only one-route map can be configured for an import policy for each export VRF.

Note. As a pre-requisite to import routes, create a route-map and define protocol preference for the route map by using **ip route-map** and **ip route-map match** commands. Route map configured for the import policy can contain any of the following filter and set options:

- Filter options: ip-address, ip-next-hop, tag, metric
- Set option: tag, metric

For route map configuration and match extensions, [“Using Route Maps” on page 16-18](#).

To import routes from the GRT to the destination VRF, enter the **ip import** command at the CLI prompt as shown:

```
-> ip import vrf V1 route-map R2
```

To disable importing of routes from the GRT, use the **no** form of this command as shown:

```
-> no ip import VRF V1
```

Configure Route Preference for Imported Routes

To configure the route preference for the routes that are imported and added to the RDB from other VRFs, use the **ip route-pref** command with the **import** parameter. For example,

```
-> ip route-pref import 100
```

Leaked routes are only for forwarding. If a local route is leaked, that interface is not accessible in the importing VRF. Another switch will not be able to ping the interface in the import VRF.

Redistribute Imported Routes

To enable redistribution of imported routes that are imported and added to the RDB from other VRFs into routing protocols in the routing instance, use the **ip service source-ip** command. For example,

```
-> ip redistrib import into ospf route-map R3 status enable
```

Verifying VRF Route Leak Configuration

A summary of the commands used for verifying the VRF Route Leak configuration is given here:

show ip export	Displays the export route configuration details.
show ip import	Displays the import route configuration details.
show ip global-route-table	Displays the GRT for all the routes that are exported from the VRFs.

The imported routes are also displayed under the protocol field as **IMPORT** in the **show ip routes**, **show ip route-pref**, **show ip redistrib**, and **show ip router database** commands.

For more information about the output details that result from the **show** commands, see the *OmniSwitch AOS Release 8 CLI Reference Guide*.

17 Configuring Multiple VRF

Multiple Virtual Routing and Forwarding (VRF) provides a mechanism for segmenting Layer 3 traffic into virtual routing domains (instances) on the same switch. Each routing instance independently maintains its own routing and forwarding table, peer, and interface information.

In This Chapter

This chapter describes the Multiple VRF feature and how to configure it through the Command Line Interface (CLI). CLI commands are used in the configuration examples; for more details about the syntax of commands, see the *OmniSwitch CLI Reference Guide*. This chapter provides an overview of Multiple VRF and includes the following information:

- [“VRF Specifications” on page 17-2.](#)
- [“VRF Defaults” on page 17-2.](#)
- [“Quick Steps for Configuring Multiple VRF” on page 17-3.](#)
- [“Multiple VRF Overview” on page 17-6.](#)
- [“VRF Interaction With Other Features” on page 17-11.](#)
- [“Configuring VRF Instances” on page 17-15.](#)
- [“Verifying the VRF Configuration” on page 17-18.](#)

VRF Specifications

The VRF functionality described in this chapter is supported unless otherwise stated in the following specifications table or specifically noted within any other section of this chapter. Note that any maximum limits provided in this table are subject to available system resources.

Platforms Supported	OmniSwitch 6860, 6860E
OmniSwitch License Requirements	Advanced License
Routing Protocols Supported	Static, IPv4, RIPv2, OSPFv2, BGP4
Maximum number of MAX profile VRF instances per switch (no LOW profiles)	64
Maximum number of LOW profile VRF instances per switch (no MAX profiles)	128
Maximum VRF instances per VLAN	1
Maximum OSPFv2 VRF routing instances per switch	16
Maximum RIPv2 VRF routing instances per switch	16
Maximum BGP VRF routing instances per switch	32
SNMP version required for management	SNMPv3

VRF Defaults

Parameter Description	Command	Default Value/Comments
Active VRF instance	vrf	Default VRF instance with max profile capabilities

Quick Steps for Configuring Multiple VRF

The initial configuration for an OmniSwitch consists of a default VRF instance. This instance is always available and is not removable. The following procedure provides a quick tutorial for creating two additional VRF instances and configuring IPv4 protocols to run in each instance:

Note. Configuring a VRF instance name is case sensitive. In addition, if the name specified does not exist, a VRF instance is automatically created. As a result, it is possible to accidentally create or delete instances. Use the **show vrf** command to verify the VRF instance configuration before selecting, adding, or removing instances.

- 1 Create VRF instance, *IpOne*, using the **vrf** command. For example:

```
-> vrf IpOne
IpOne::->
```

In this example, the change in the command prompt from “->” to “IpOne: ->” indicates that the instance was created and is now the active VRF CLI context. Any commands entered at this point apply to this instance, unless the commands entered are not supported in multiple VRF instances.

- 2 Create a second VRF instance, *IpTwo*, using the **vrf** command. For example:

```
IpOne::-> vrf IpTwo
IpTwo::->
```

In this example, *IpOne* was the active instance until *IpTwo* was created and replaced *IpOne* as the active VRF CLI context.

- 3 Select *IpOne* for the active VRF instance and create an IP router interface on VLAN 100 and VLAN 101 using the **ip interface** command. For example:

```
IpTwo::-> vrf IpOne
IpOne::-> ip interface intf100 address 100.1.1.1/24 vlan 100
IpOne::-> ip interface intf101 address 101.1.1.1/24 vlan 101
IpOne::->
```

- 4 Configure 1.1.1.1 as the primary router ID address for the *IpOne* VRF instance using the **ip router router-id** command. For example:

```
IpOne::-> ip router router-id 1.1.1.1
IpOne::->
```

- 5 Create an IP static route for the *IpOne* VRF instance using the **ip static-route** command. For example:

```
IpOne::-> ip static-route 192.100.1.1/24 gateway 100.1.1.10
IpOne::->
```

- 6 Load and enable the RIP protocol for the *IpOne* VRF instance using the **ip load rip** and **ip rip admin-state** commands. For example:

```
IpOne::-> ip load rip
IpOne::-> ip rip admin-state enable
IpOne::->
```

- 7** Enable RIP on IP interface “intf100” in the *IpOne* VRF instance using the **ip rip interface admin-state** command. For example:

```
IpOne::-> ip rip interface intf100 admin-state enable
IpOne::->
```

- 8** Select *IpTwo* for the active VRF instance and create an IP router interface on VLAN 102 using the **ip interface** command. For example:

```
IpOne::-> vrf IpTwo
IpTwo::-> ip interface intf102 address 102.1.1.1/24 vlan 102
IpTwo::->
```

- 9** Configure 2.2.2.2 as the primary router ID address for the *IpTwo* VRF instance using the **ip router router-id** command. For example:

```
IpTwo::-> ip router router-id 2.2.2.2
IpTwo::->
```

- 10** Load and enable the BGP protocol for the *IpTwo* VRF instance using the **ip load bgp** command. For example:

```
IpTwo::-> ip load bgp
IpTwo::->
```

- 11** Configure a BGP neighbor for the *IpTwo* VRF instance using the **ip bgp neighbor**, **ip bgp neighbor remote-as**, and **ip bgp neighbor admin-state** commands. For example:

```
IpTwo::-> ip bgp neighbor 102.1.1.10
IpTwo::-> ip bgp neighbor 102.1.1.10 remote-as 1000
IpTwo::-> ip bgp neighbor 102.1.1.10 status enable
```

- 12** *Optional.* To configure a VRF instance as a low profile VRF (restricted routing protocols and capabilities) use the **vrf** command with the **profile low** parameter option. For example:

```
IpTwo::-> vrf IpThree profile low
IpThree::->
```

By default, a VRF instance is created using max profile capabilities. Low profile VRFs use less switch resources, which allows more VRF instances to operate on the switch.

Note. Verify the Multiple VRF configuration using the **show vrf** command:

```
IpOne::-> show vrf
Virtual Routers      Profile Protocols
-----+-----+-----
default             default BGP PIM VRRP
IpOne                max      RIP
IpTwo                max      BGP
IpThree              low

Total Number of Virtual Routers: 4
```

To verify the configuration of a protocol within a VRF instance, use the show commands related to that protocol. For example, the **show ip interface** command displays the IP interfaces associated with the current CLI VRF context:

```

-> vrf IpOne
IpOne: -> show ip interface
Total 1 interfaces
      Name                IP Address      Subnet Mask    Status Forward Device
-----+-----+-----+-----+-----+-----
intfone                200.1.1.1      255.255.255.0 DOWN          NO   vlan 200

```

See the *OmniSwitch CLI Reference Guide* for information about the fields in the above displays.

An example of what the Quick Steps configuration commands look like when entered sequentially on the switch:

```

-> vlan 100
-> vlan 101
-> vlan 102
-> vrf IpOne
IpOne::-> vrf IpTwo
IpTwo::-> vrf IpOne
IpOne::-> ip interface intf100 address 100.1.1.1/24 vlan 100
IpOne::-> ip interface intf101 address 101.1.1.1/24 vlan 101
IpOne::-> ip router router-id 1.1.1.1
IpOne::-> ip static-route 192.100.1.1/24 gateway 100.1.1.10
IpOne::-> ip load rip
IpOne::-> ip rip admin-state enable
IpOne::-> ip rip interface intf100 admin-state enable
IpOne::-> vrf IpTwo
IpTwo::-> ip interface intf102 address 102.1.1.1/24 vlan 102
IpTwo::-> ip router router-id 2.2.2.2
IpTwo::-> ip load bgp
IpTwo::-> ip bgp neighbor 102.1.1.10
IpTwo::-> ip bgp neighbor 102.1.1.10 remote-as 1000
IpTwo::-> ip bgp neighbor 102.1.1.10 admin-state enable
IpTwo::-> vrf IpThree profile low

```

Multiple VRF Overview

The Multiple Virtual Routing and Forwarding (VRF) feature provides the ability to configure separate routing instances on the same switch. Similar to using VLANs to segment Layer 2 traffic, VRF instances are used to segment Layer 3 traffic.

Some of the benefits of using the Multiple VRF feature include the following:

- Multiple routing instances within the same physical switch. Each VRF instance is associated with a set of IP interfaces and creates and maintains independent routing tables. Traffic between IP interfaces is only routed and forwarded to those interfaces that belong to the same VRF instance.
- Multiple instances of IP routing protocols, such as static, RIP, IPv4, BGPv4, and OSPFv2 on the same physical switch. An instance of each type of protocol operates within its own VRF instance.
- The ability to use duplicate IP addresses across VRF instances. Each VRF instance maintains its own IP address space to avoid any conflict with the service provider network or other customer networks.
- Separate IP routing domains for customer networks. VRF instances configured on the Provider Edge (PE) are used to isolate and carry customer traffic through the shared provider network.

This implementation of VRF functionality does not require a BGP/MPLS configuration in the provider network. Instead, VRF instances can route and forward IP traffic between customer sites using point-to-point Layer 3 protocols, such as IP-IP or GRE tunneling.

The illustration on [page 17-7](#) shows an example of how the Multiple VRF feature is used to provide independent routing domains that isolate and carry customer traffic through the provider network. In this example:

- Each PE switch maintains more than one routing and forwarding table, in addition to the default VRF instance table.
- One VRF instance is configured on the PE switch for each customer network to which the PE is connected.
- Each interface on the PE that is connected to a customer edge (CE) switch is associated with the VRF instance configured for that customer.
- When an IP packet for Customer A is received on a PE 1 or PE 2 interface associated with VRF A, the VRF A instance determines how to route the packet through the provider backbone so that it reaches the intended Customer A destination.
- When an IP packet for Customer B is received on a PE 1, PE 2, or PE 3 interface associated with VRF B, the VRF B instance determines how to route the packet through the provider backbone so that it reaches the intended Customer B destination.
- When an IP packet for Customer C is received on a PE 1 or PE 3 interface associated with VRF C, the VRF C instance determines how to route the packet through the provider backbone so that it reaches the intended Customer C destination.

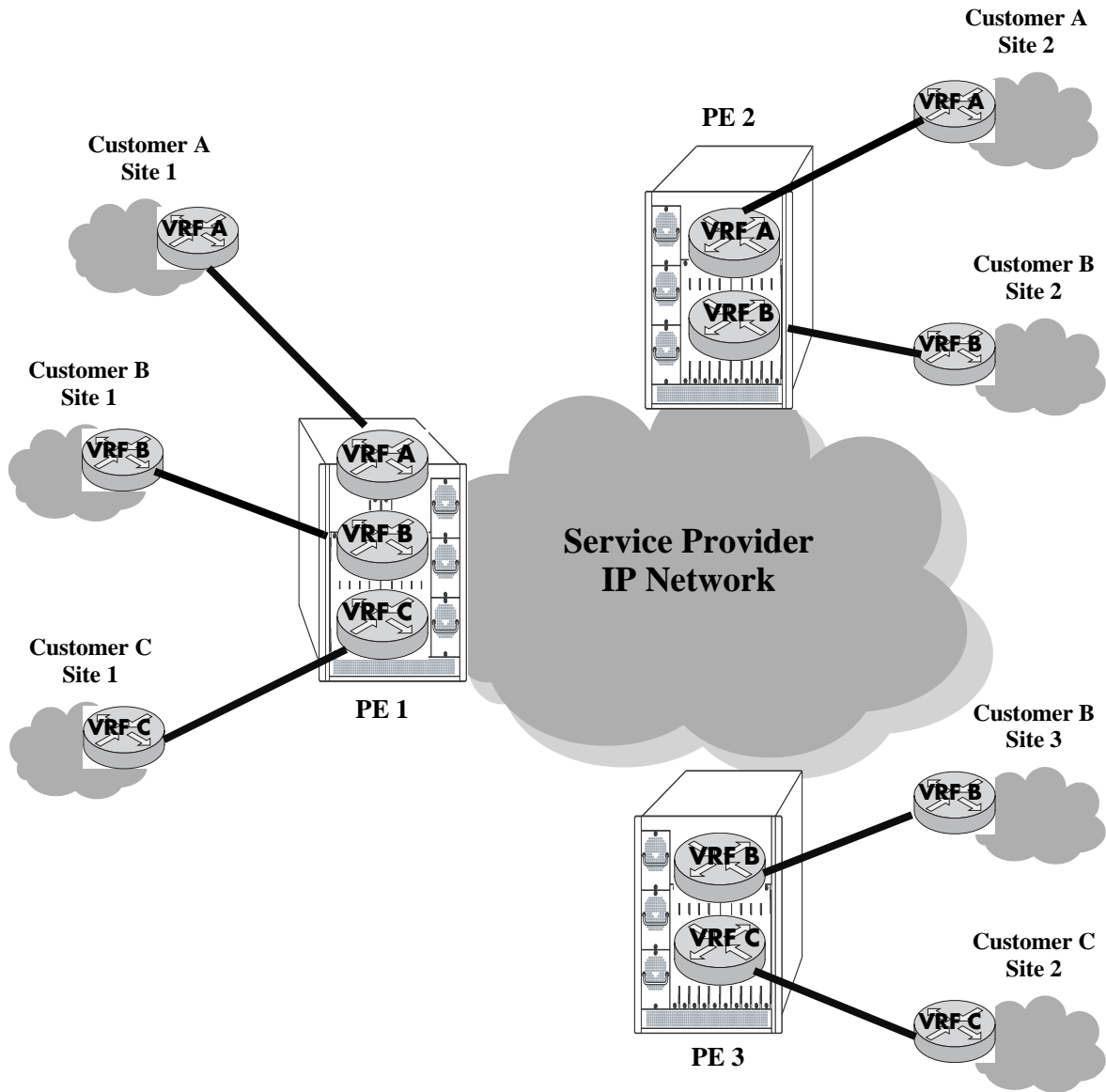

Example Multiple VRF Configuration

VRF Profiles

The VRF feature supports two types of VRF instances: a low profile instance and a max profile instance. The type of profile assigned to a VRF instance determines the routing protocols and capabilities supported within that instance.

- Low profile VRFs only support IPv4 and VRRP, with routing capabilities restricted to static and imported routes. In addition, limiting low profiles to 9 routes and 3 IP interfaces is highly recommended.
- Max profile VRFs support full VRF routing capabilities and limits.

The type of profile applied is determined at the time the VRF instance is created. The default VRF instance uses the max profile capabilities; configuring the default VRF profile is not allowed.

Using low profile VRFs gives an administrator the ability to create VRFs with minor routing capabilities and complexity. Low profiles take up less switch resources than max profiles, which allows for creating more VRFs on the switch.

The ability to create many low profile VRFs is particularly useful in cases where all traffic only flows through a handful of individual routes to reach specific destinations; the administrator can separate many network access points into VRFs. For example: in a building there may be many tenants that need to reach several end stations and one or two WAN access points through a shared core network. Each private network needs its own address space, but does not need a routing protocol to share many routes (may only need a default route).

A combination of low and max profiles is allowed on the switch. However, the total number of VRFs allowed on the switch may differ depending on the availability of switch resources and the number of low and max profile VRFs configured.

Using the VRF Command Line Interface

The Multiple VRF feature uses a context-based command line interface (CLI). When the switch boots up, the default VRF instance is automatically created and active. Any commands subsequently entered apply to this default instance. If a different VRF instance is selected, then all subsequent commands apply to that instance.

Note. Only those commands for features that are VRF aware are accepted within the context of a VRF instance. Default VRF applications are supported only in the default VRF instance. For more information about VRF supported applications, see [“VRF Interaction With Other Features” on page 17-11](#)

The CLI command prompt indicates which instance is the active VRF context; the instance name is added as a prefix to the command prompt. For example, if VRF instance *IpOne* is the current context, then *IpOne* appears in the CLI command prompt. For example:

```
IpOne: ->
```

When the default VRF instance is the active context, no VRF name appears in the command prompt. For example, the following prompt indicates that the default VRF instance is the current context:

```
->
```

It is also possible to enter configuration commands for other non-default instances from within the default VRF CLI context. For more information about how to do this and additional examples of using the VRF

context-based CLI, see [“Configuring VRF Instances” on page 17-15](#) and [“Verifying the VRF Configuration” on page 17-18](#).

Note. All VRF instances are active in terms of routing and forwarding tasks whether or not the instance is the current CLI context. Selecting a VRF instance as the CLI context simply indicates the instance to which any configuration or show commands apply.

ASCII-File-Only Syntax

When configuration commands for VRF-aware applications are configured and saved in an ASCII file (typically through the **snapshot** command) or the switch **vcboot.cfg** file, a prefix is added to these commands to indicate the name of the VRF instance to which the commands apply. For example:

```
! VRF
vrf vrfOne
! IP
vrf vrfOne ip interface intf100 address 100.1.1.1/24 vlan 100
vrf vrfOne ip interface intf101 address 101.1.1.1/24 vlan 101
vrf vrfOne ip router router-id 1.1.1.1
vrf vrfOne ip static route 192.100.1.0/24 gateway 100.1.1.10
! RIP
vrf vrfOne ip load rip
vrf vrfOne ip rip status enable
vrf vrfOne ip rip interface intf100 status enable
```

In this example, *vrfOne* is added to the beginning of the IP and RIP configuration command lines. This indicates that these commands apply to the *vrfOne* instance. If a command line does not contain an instance name, then that command is for an application that applies only to the default VRF instance or the application is not VRF-aware.

Default VRF commands appear first in an ASCII or **vcboot.cfg** file, followed by commands for VRF-aware applications configured in non-default instances.

Management VRF

The Management VRF feature gives the user the ability to control which VRF is used for the various switch management protocols (Telnet, RADIUS, and so on.)

The following level of support is provided:

- Level 0 - The management service may only appear in the Default VRF.
- Level 1 - User may specify a single VRF that all management services can be configured in. For example, both RADIUS and LDAP can use vrf-1.
- Level 2 - Each management service or multiple management services can be configured for a different VRF. For example, RADIUS in vrf-1, LDAP in vrf-2, SNMP in vrf-3.
- Level 3 - A management service can appear in multiple VRFs. For example, SSH and Telnet in vrf-1 and vrf-2.

Level	Description	Telnet/SSH/SFTP/ SCP	Radius/SNMP/HTTP/HTTPS/ NTP/LDAP/TACACS+/Syslog
0	Default VRF Only	Yes	Yes
1	Single VRF for all services	Yes	Yes
2	Single VRF per service, each service can be on a different VRF	Yes	Yes
3	Multiple VRFs per service, any service on any VRF	Yes	No

VRF Interaction With Other Features

This section contains important information about how other OmniSwitch features interact with VRF instances. Refer to the specific chapter for each feature to get more detailed information about how to configure and use the feature.

All OmniSwitch AOS applications fall into one of the following three categories in relation to the Multiple VRF feature:

- **VRF Aware.** Switch applications that are configurable independently and separately within one or more VRF instances. All VRF aware applications can be enabled or disabled on each VRF instance.
- **Default VRF.** Switch applications that are VRF aware but only use the default VRF instance when IP connectivity is needed; these applications are not supported across multiple VRF instances.
- **Non-VRF Aware.** Switch applications that have no association with any VRF instance, even the default instance. Note that configuration of this type of application is only allowed when the default instance is the active CLI context.

Refer to the following table to determine the VRF association for a specific switch application. Applications that do not appear in this table are non-VRF aware.

VRF-Aware Applications		Default VRF Applications	
BFD	Telnet Server	IPv6 (NDP/Tunnel)	DNS Client
Static routes	VRRPv2	BGPv6	Telnet Client
IPv4/ARP	QoS VRF Policies	RIPng	FTP Client
RIPv2	UDP/DHCP Relay	IS-ISv6	SSH Client
BGPv4	AAA RADIUS Server	OSPFv3	AAA
OSPFv2	TACACS+ Server	VRRPv3	Trap Manager
PIM-DM (IPv4)	LDAP Server	SFTP	Router Discovery Protocol
PIM-SM (IPv4)	FTP Server	Policy Based Routing	EMP access
Route Map	NTP		
Redistribution	SNMP (Agent)		
IP-IP Tunnels	HTTP Server		
GRE Tunnels	Webview		
Ping	DVMRP		
Traceroute	IS-ISv4		
SSH Server (SSH, SFTP, SCP)			

The following subsections provide additional information related to Multiple VRF interaction with specific applications.

AAA RADIUS/TACACS+/LDAP Servers

- AAA RADIUS or TACACS+ or LDAP server can be configured on any VRF instance including the default VRF instance. However, all of the servers (for example, all the RADIUS servers) must reside on the same VRF instance.
- The VRF instance that the server is configured on becomes the “management” VRF instance and can perform authentication for any of the following services:

Console	HTTP
Telnet	SNMP
FTP	
SSH (ssh, sftp, and scp)	

- If the VRF instance that the servers (RADIUS / TACACS+ / LDAP) reside on is deleted or disabled, access to the servers is disabled as well.
- More than one management service can use the same VRF instance. For example, both RADIUS and LDAP can use the same VRF instance “VrfA”.

BGPv4

- Each BGPv4 routing instance requires configuration of an Autonomous System number, router ID number, and primary IP address that is explicit to the associated VRF instance.
- BGP neighbors defined for a specific VRF instance and address family (IPv4 and IPv6) peer with neighbors accessible through interfaces associated with the same VRF instance.

IP-IP and GRE Tunnels

Tunnel endpoint addresses always exist in the default VRF instance regardless of the instance in which the tunnel interface is configured.

Management Applications (Telnet and SSH)

- Telnet and SSH (SSH, SFTP, and SCP) sessions “to” the switch are VRF aware. Client support for these utilities is supported only in the default VRF instance.
- A maximum of four combined Telnet sessions are allowed simultaneously across all VRFs on the switch.
- A maximum of eight combined SSH sessions are allowed simultaneously across all VRFs on the switch.
- More than one VRF including the default VRF can be used for Telnet / SSH sessions.

FTP

- FTP session “to” the switch is VRF aware.
- A maximum of four combined FTP sessions are allowed simultaneously across all VRFs on the switch.

NTP

Supports VRF configuration for all NTP operations (both client and server).

WebView

Supports VRF configuration for "WebView Server" and "WebView Access".

Syslog Server

Supports VRF configuration for forwarding swlog output to the syslog daemon of the switch (or host).

Quality of Service (QoS)

- The Auto-NMS feature (non-VRF aware) recognizes all of the IP interfaces configured in the default VRF instance. The first eight of these interfaces are prioritized by Auto-NMS to ensure switch manageability in the event of a DoS attack.
- Policy Based Routing, as indicated in the table above, is a default VRF application. The functionality of this feature remains the same as in releases prior to the implementation of Multiple VRF instances.

VRF Policies

- A VRF policy condition parameter is available to specify a VRF name to which the policy condition applies. This parameter can also specify the default VRF, and a **no** form of the command exists to remove a VRF condition parameter. For example:

```
-> qos policy condition c1 vrf engr_vrf
-> qos policy condition c2 vrf default
-> qos policy condition c1 no vrf
```
- VRF policies are configured in the default VRF, similar to how all other QoS policies are configured. If the VRF name specified does not exist, the policy is not allocated any system resources.
- Policies that do not specify a VRF name are considered global policies and are applied across all VRF instances and VLANs.
- Policies that specify the default VRF apply only to traffic in the default VRF instance.
- Policies that specify a VRF name apply only to traffic in the VRF instance associated with that name.
- The **switch** network group is supported only in VRF policies that specify the default VRF instance. If this group is specified in a global policy (no VRF specified) then the policy is applied across all VRF instances.

SNMP

- SNMPv3 is required to manage VRF instances; SNMPv1 and v2 are not supported.
- Configuring the management station to use SNMPv3 is required to receive traps from VRF-aware applications.

VLANs

Configuring an interface for a VLAN also associates that VLAN with the active VRF context. A VLAN, however, can only belong to one VRF instance at a time. As a result, all interfaces configured for a VLAN must belong to the same VRF instance. See [“Assigning IP Interfaces to a VRF Instance”](#) on page 17-17 for more information.

UDP/DHCP Relay

VRF support for UDP/DHCP Relay allows for the configuration and management of relay agents and servers within the context of a VRF instance.

The following guidelines apply when configuring UDP/DHCP Relay within the context of VRF instances:

- A separate DHCP server is required for each VRF instance to which DHCP packets are relayed to and from the server. The server must reside in the same VRF as the originating requests. For example, the following command configures the DHCP server address for the *vrfOne* instance:

```
-> vrf vrfOne
vrfOne:> ip helper address 10.0.0.1
```

The above configuration relays all DHCP packets within the *vrfOne* instance to the specified server which also resides in the *vrfOne* instance.

- A separate UDP relay setting for port/service to VLAN is required per VRF instance. For example, the following command configures the forwarding of specific UDP packets to VLAN 100 within the context of the *vrfTwo* instance:

```
-> ip udp dns vlan 100
```

- When a VRF instance is deleted, all UDP/DHCP Relay configuration associated with that instance is also deleted. However, if the VRF instance is created again with the same name, the relay configuration previously associated with that name is *not* restored.

Configuring VRF Instances

Configuring the Multiple VRF feature consists of the following:

- Creating a VRF instance with a low profile or the default max profile.
- Assigning one or more IP interfaces to the instance.
- Configuring routing protocols to operate within a specific instance.

The initial configuration of an Alcatel-Lucent switch consists of a default VRF instance, which is always active when the switch starts up and is not removable from the switch configuration. Any subsequent configuration of switch applications applies only to the default instance. To provide multiple, independent IP routing domains on the same switch, configuring additional VRF instances is required.

The VRF CLI is context-based in that commands used to configure VRF-aware applications are applied to the active VRF instance. A VRF instance becomes active when the instance is either created or selected using the **vrf** command.

A VRF instance is identified by a name, which is specified at the time the instance is configured. For example, the following command creates the *IpOne* instance:

```
-> vrf IpOne
IpOne: ->
```

In this example, instance *IpOne* is created and made the active VRF context at the same time. Note that the CLI command prompt indicates the active context by displaying the name of the VRF instance as part of the actual prompt. Any subsequent commands entered on this command line are applied to the *IpOne* instance.

Within the context of the default VRF instance, it is also possible to enter configuration commands for another instance. For example, to configure an IP interface for instance *IpOne* from within the CLI context of the default instance, prefix the **ip interface** command with **vrf** command followed by the name of the instance. For example:

```
-> vrf IpOne ip interface intf100 address 100.1.1.1/24 vlan 100
->
```

The above command creates the IP interface for VRF *IpOne* but does not change the CLI context in which the command was entered. The default VRF instance remains the active context.

Note. The default VRF instance is the only VRF CLI context within which configuration of another instance is allowed.

Configuring the VRF Profile

By default, the max profile capabilities are applied when a VRF instance is created. A max profile VRF supports dynamic routing protocols and other supported VRF limits. To create a VRF instance with low profile capabilities, use the **vrf** command with the **profile low** parameter. For example:

```
-> vrf IpTwo profile low
IpTwo-low:-->
```

Changing the profile for an existing VRF instance is not allowed. To change the profile, first delete the VRF then create it again with a different profile. For example, to change profile *IpTwo* to a max profile VRF, use the following commands:

```
-> no vrf IpTwo
-> vrf IpTwo profile max
IpTwo-low::->
```

In this example, the **profile max** parameter option is not needed, since the max profile is applied by default. However, this parameter was used here to demonstrate the command syntax.

The total number of VRFs allowed depends on the available switch memory. At 80% memory usage, a low memory warning is displayed when a new VRF is created. When 90% usage is reached, creating a new VRF is stopped. For example:

```
-> vrf LowProfVrf500 profile low
+++ WARNING: Memory usage over 80%, creating VRF

->vrf LowProfVrf512 profile low
ERROR: resource allocation failure
+++ ERROR: Memory usage over 90%, VRF creation failed
```

Selecting a VRF Instance

Moving between VRF instances is done by selecting an existing instance to become the active VRF CLI context. The **vrf** command is also used to select an existing instance. For example, the following command selects the *IpTwo* instance:

```
IpOne: -> vrf IpTwo
IpTwo: ->
```

In the above example, selecting the *IpTwo* instance changed the VRF CLI context from *IpOne* to *IpTwo*. Any subsequent commands entered apply to the *IpTwo* instance.

Note. If the instance name specified with the **vrf** command does not exist, a VRF instance is automatically created. In addition, configuring a VRF instance name is case sensitive. As a result, it is possible to accidentally create or delete instances. Use the **show vrf** command to verify the VRF instance configuration before selecting, adding, or removing instances.

To return to the default VRF instance from within the context of another instance, enter the **vrf** command with or without the optional **default** parameter. For example, both of the following commands return the CLI context to the default VRF instance:

```
IpOne: -> vrf
IpOne: -> vrf default
```

Note that the command prompt for the default VRF instance does not display the instance name.

Assigning IP Interfaces to a VRF Instance

When a VRF instance is created or an existing instance is selected, any IP interface subsequently configured is associated with that instance. For example, the following commands select the *IpOne* VRF instance and configure an IP interface for that instance:

```
-> vrf IpOne
IpOne: -> ip interface intf100 address 100.1.1.1/24 vlan 100
IpOne: ->
```

Once an IP interface is associated with a VRF instance, Layer 3 traffic on that interface is routed within the domain of the VRF instance. In other words, such traffic is only routed between other IP interfaces that are associated with the same VRF instance. Any additional routing protocol traffic configured for that same interface is also routed within the associated VRF domain.

Use the following guidelines when configuring IP interfaces for a VRF instance:

- A single IP interface as well as the VLAN associated with the interface, can only belong to one VRF instance at a time.
- Once a VLAN is associated with a specific VRF instance, configuring an interface for that VLAN within the context of any other instance, is not allowed. For example, if the first IP interface configured for VLAN 100 was associated with the VRF *IpOne* instance, then any subsequent IP interface configuration for VLAN 100 is only allowed within the context of the *IpOne* instance.
- A VRF instance can have multiple VLAN associations, even though a VLAN can only have one VRF association.

Configuring Routing Protocols for a Specific VRF Instance

There are no additional CLI commands or parameters required to associate a routing protocol configuration (for example, RIP, BGP, OSPF) with a specific VRF instance. Instead, the VRF CLI context is used to determine the association between a specific routing configuration and a VRF instance. For example, if a BGP routing instance is configured when VRF instance *IpOne* is the active CLI context, then the BGP routing instance is associated with *IpOne*. All traffic for the BGP instance is routed and forwarded on the interfaces associated with VRF *IpOne*.

For more information about the interaction of switch applications with VRF instances, see [“VRF Interaction With Other Features” on page 17-11](#). To see examples of configuring routing protocol instances within the context of a VRF instance, refer to [“Quick Steps for Configuring Multiple VRF” on page 17-3](#).

Removing a VRF Instance

To remove a VRF instance from the switch configuration, use the **no** form of the **vrf** command. For example:

```
-> no vrf IpTwo
```

To view a list of VRF instances configured on the switch, use the **show vrf** command. For more information about this command, see the *OmniSwitch CLI Reference Guide*.

Verifying the VRF Configuration

To display a list of VRF instances configured for the switch, use the **show vrf** command. For example:

```
-> show vrf
Virtual Routers      Profile Protocols
-----+-----+-----
default             default BGP PIM VRRP
IpOne               max     RIP
IpTwo               max     BGP
IpThree            low
```

The VRF CLI context determines which information is displayed using application-specific **show** commands. For example, if *IpOne* is the active VRF context, then only IP interfaces associated with *IpOne* are displayed.

```
-> vrf IpOne
IpOne: -> show ip interface
Total 1 interfaces
      Name                IP Address      Subnet Mask      Status Forward  Device
-----+-----+-----+-----+-----+-----
Loopback                127.0.0.1      255.0.0.0        UP           NO Loopback
intfone                 200.1.1.1      255.255.255.0    DOWN        NO vlan 200

IpOne: -> vrf default
-> show ip interface
Total 6 interfaces
      Name                IP Address      Subnet Mask      Status Forward  Device
-----+-----+-----+-----+-----+-----
EMP                    192.168.10.1   255.255.255.0    DOWN        NO EMP
Loopback                127.0.0.1      255.0.0.0        UP           NO Loopback
vlan 130                192.168.130.161 255.255.255.0    DOWN        NO vlan 130
vlan 2                  10.255.11.161  255.255.255.0    UP          YES vlan 2
vlan-2000               172.20.0.1     255.255.0.0      UP          YES vlan 2000
vlan-2100               172.21.0.1     255.255.0.0      UP          YES vlan 2100
```

Note that when the default VRF CLI context is active, the **show** commands can display specific information for another instance. This is done by first entering the **vrf** command followed by the instance name and then the **show** command. For example, the following command displays the IP interfaces configured for *IpOne* from within the context of the default VRF CLI:

```
-> vrf IpOne show ip interface
```

For more information about the displays that result from these commands, see the *OmniSwitch AOS Release 8 CLI Reference Guide*.

18 Configuring IPv6

Internet Protocol version 6 (IPv6) is the next generation of Internet Protocol version 4 (IPv4). Both versions are supported along with the ability to tunnel IPv6 traffic over IPv4. Implementing IPv6 solves the limited address problem currently facing IPv4, which provides a 32-bit address space. IPv6 increases the address space available to 128 bits.

In This Chapter

This chapter describes IPv6 and how to configure it through Command Line Interface (CLI). The CLI commands are used in the configuration examples; for more details about the syntax of commands, see the *OmniSwitch AOS Release 8 CLI Reference Guide*.

This chapter provides an overview of IPv6 and includes information about the following procedures:

- Configuring an IPv6 interface (see [page 18-15](#))
- Configuring a Unique Local Ipv6 Interface (see [page 18-15](#))
- Assigning IPv6 Addresses (see [page 18-17](#))
- Configuring IPv6 Tunnel Interfaces (see [page 18-19](#))
- Creating a Static Route (see [page 18-20](#))
- Configuring the Route Preference of a Router (see [page 18-21](#))
- Configuring Route Map Redistribution (see [page 18-22](#))
- Configuring Local Proxy Neighbor Discovery (LPND) (See [page 18-27](#))
- Configuring Router Advertisement (RA) Filtering (See [page 18-29](#))
- Configuring Neighbor Cache Limit (See [page 18-27](#))
- Configuring Neighbor Unreachability Detection (NUD) (See [page 18-28](#))
- DHCPv6 Relay Overview (See [page 18-30](#))
- Quick Steps for Configuring DHCPv6 Relay (See [page 18-29](#))
- DHCPv6 Relay Configuration Overview (See [page 18-31](#))

IPv6 Specifications

Note that the maximum limit values provided in the following Specifications table are subject to available system resources:

Platforms Supported	OmniSwitch 6860, 6860E
RFCs Supported	1981 – Path MTU Discovery for IP version 6 2375 – IPv6 Multicast Address Assignments 2460 – Internet Protocol, Version 6 (IPv6) Specification 2464 – Transmission of IPv6 Packets over Ethernet Networks 2465 – Management Information Base for IP Version 6: Textual Conventions and General Group 2466 – Management Information Base for IP Version 6: ICMPv6 Group 2711 – IPv6 Router Alert Option 3056 – Connection of IPv6 Domains through IPv4 Clouds 3484 – Default Address Selection for Internet Protocol version 6 (IPv6) 3493 – Basic Socket Interface Extensions for IPv6 3542 – Advanced Sockets Application Program Interface (API) for IPv6 3587 – IPv6 Global Unicast Address Format 3595 – Textual Conventions for IPv6 Flow Label 3596 – DNS Extensions to Support IP Version 6 4007 – IPv6 Scoped Address Architecture 4022 – Management Information Base for the Transmission Control Protocol (TCP) 4113 – Management Information Base for the User Datagram Protocol (UDP) 4193 – Unique Local IPv6 Unicast Addresses 4213 – Basic Transition Mechanisms for IPv6 Hosts and Routers 4291 – IP Version 6 Addressing Architecture 4294 – IPv6 Node Requirements 4443 – Internet Control Message Protocol (ICMPv6) for the Internet Protocol Version 6 (IPv6) Specification 4861 – Neighbor Discovery for IP version 6 (IPv6) 4862 – IPv6 Stateless Address auto-configuration 5095 – Deprecation of Type 0 Routing Headers in IPv6 5453 – Reserved IPv6 Interface Identifiers 5722 – Handling of Overlapping IPv6 Fragments 3315 – Dynamic Host Configuration Protocol for IPv6 (DHCPv6)
Maximum IPv6 interfaces	VLANs- 4096 Configured Tunnels - 255 6to4 Tunnels - 1
Maximum IPv6 global unicast or anycast addresses	10K
Maximum IPv6 global unicast addresses per IPv6 interface	50

Maximum IPv6 addresses assigned through VRRP configuration	1K
Maximum IPv6 hardware routes when there are no IPv4 routes present (includes dynamic and static routes)	OS6860 - 1K (prefix >= 65) OS6860 - 6K (prefix <= 64) (Note: Exceeding these limits, or having IPv4 routes will result in some traffic being routed in software)
Maximum IPv6 static route prefixes per switch	500
Maximum Number of RIPng Peers	10
Maximum Number of RIPng Interfaces	10
Maximum Number of RIPng Routes	5K
Maximum next hops per ECMP entry (static or RIPng routes)	16
DHCPv6 Implementation	multi-VRF
DHCPv6 Relay Implementation	IPv6 Interface (VLAN, configured tunnel, 6to4 tunnel)
DHCPv6 Relay Service	DHCPv6, UDPv6
Maximum IPv6 relay destinations supported for each Interface	5
Maximum number of Relay Hops for each relay	32

IPv6 Defaults

The following table lists the defaults for IPv6 configuration through the **ipv6** command.

Description	Command	Default
Global status of IPv6 on the switch	N/A	Enabled
Interfaces	ipv6 interface	loopback, 6to4 tunnel
Hop Limit	ipv6 hop-limit	64
Path MTU entry minimum lifetime	ipv6 pmtu-lifetime	10 minutes
Neighbor stale lifetime	ipv6 neighbor stale-lifetime	10 minutes
Neighbor cache system limit	ipv6 neighbor limit	none

Quick Steps for Configuring IPv6 Routing

The following tutorial assumes that VLAN 200 and VLAN 300 already exist in the switch configuration. For information about how to configure VLANs, see [Chapter 4, “Configuring VLANs.”](#)

- 1 Configure an IPv6 interface for VLAN 200 by using the **ipv6 interface** command. For example:

```
-> ipv6 interface v6if-v200 vlan 200
```

Note that when the IPv6 interface is configured, the switch automatically generates a link-local address for the interface. This allows for communication with other interfaces and/or devices on the same link, but does not provide routing between interfaces.

- 2 Assign a unicast address to the *v6if-v200* interface by using the **ipv6 address** command. For example:

```
-> ipv6 address 2001:db8:4100:1::/64 eui-64 v6if-v200
```

- 3 Configure an IPv6 interface for VLAN 300 by using the **ipv6 interface** command. For example:

```
-> ipv6 interface v6if-v300 vlan 300
```

- 4 Assign a unicast address to the *v6if-v300* interface by using the **ipv6 address** command. For example:

```
-> ipv6 address 2001:db8:4100:2::/64 eui-64 v6if-v300
```

Note. Optional. To verify the IPv6 interface configuration, enter **show ipv6 interface** For example:

```
-> show ipv6 interface
```

Name	IPv6 Address/Prefix Length	Status	Device
v6if-v200	fe80::2d0:95ff:fe12:fab5/64 2001:db8:4100:1::2d0:95ff:fe12:fab5/64 2001:db8:4100:1::/64	Down	VLAN 200
v6if-v300	fe80::2d0:95ff:fe12:fab6/64 2001:db8:4100:2::2d0:95ff:fe12:fab6/64 2001:db8:4100:2::/64	Down	VLAN 300
loopback	::1/128 fe80::1/64	Active	Loopback

Note that the link-local addresses for the two new interfaces and the loopback interface were automatically created and included in the **show ipv6 interface** display output. In addition, the subnet router anycast address that corresponds to the unicast address is also automatically generated for the interface.

- 5 Enable RIPng for the switch by using the **ipv6 load rip** command. For example:

```
-> ipv6 load rip
```

- 6 Create a RIPng interface for each of the IPv6 VLAN interfaces by using the **ipv6 rip interface** command. For example:

```
-> ipv6 rip interface v6if-v200
```

```
-> ipv6 rip interface v6if-v300
```

IPv6 routing is now configured for VLAN 200 and VLAN 300 interfaces, but it is not active until at least one port in each VLAN goes active.

IPv6 Overview

IPv6 provides the basic functionality that is offered with IPv4 but includes the following enhancements and features not available with IPv4:

- **Increased IP address size**—IPv6 uses a 128-bit address, a substantial increase over the 32-bit IPv4 address size. Providing a larger address size also significantly increases the address space available, thus eliminating the concern over running out of IP addresses. See [“IPv6 Addressing” on page 18-7](#) for more information.
- **Auto-configuration of addresses**—When an IPv6 interface is created or a device is connected to the switch, an IPv6 link-local address is automatically assigned for the interface and/or device. See [“Auto-configuration of IPv6 Addresses” on page 18-9](#) for more information.
- **Anycast addresses**—A new type of address. Packets sent to an anycast address are delivered to one member of the anycast group.
- **Simplified header format**—A simpler IPv6 header format is used to keep the processing and bandwidth cost of IPv6 packets as low as possible. As a result, the IPv6 header is only twice the size of the IPv4 header despite the significant increase in address size.
- **Improved support for header options**—Improved header option encoding allows more efficient forwarding, fewer restrictions on the length of options, and greater flexibility to introduce new options.
- **Security improvements**—Extension definitions provide support for authentication, data integrity, and confidentiality.
- **Neighbor Discovery protocol**—A protocol defined for IPv6 that detects neighboring devices on the same link and the availability of those devices. Additional information that is useful for facilitating the interaction between devices on the same link is also detected (for example, neighboring address prefixes, address resolution, duplicate address detection, link MTU, and hop limit values, etc.).

This implementation of IPv6 also provides the following mechanisms to maintain compatibility between IPv4 and IPv6:

- Dual-stack support for both IPv4 and IPv6 on the same switch.
- Configuration of IPv6 and IPv4 interfaces on the same VLAN.
- Tunneling of IPv6 traffic over an IPv4 network infrastructure.
- Embedded IPv4 addresses in the four lower-order bytes of the IPv6 address.

The remainder of this section provides a brief overview of the new IPv6 address notation, auto-configuration of addresses, and tunneling of IPv6 over IPv4.

IPv6 Addressing

One of the main differences between IPv6 and IPv4 is that the address size has increased from 32 bits to 128 bits. Going to a 128-bit address also increases the size of the address space to the point where running out of IPv6 addresses is not a concern.

The following types of IPv6 addresses are supported:

Link-local—A link-local address is a private unicast address that identifies an interface or device on the local network. This type of address allows communication with devices and/or neighboring nodes that are attached to the same physical link. Note that when the communication is between two nodes that are not attached to the same link, both nodes must have a configured global unicast address. Routing between link-local addresses is not available because link-local addresses are not known or advertised to the general network. Link-local addresses are unique only for a link and the same link-local address may be used on multiple interfaces.

Unicast—Standard unicast addresses, similar to IPv4.

Unique Local IPv6 Unicast—IPv6 unicast address format that is globally unique and intended for local communications, usually inside of a site. These addresses are not expected to be routable on the global Internet.

Multicast—Addresses that represent a group of devices. Traffic sent to a multicast address is delivered to all members of the multicast group.

Anycast—Traffic that is sent to this type of address is delivered to one member of the anycast group. The device that receives the traffic is usually the one that is easiest to reach as determined by the active routing protocol.

Note. IPv6 does not support the use of broadcast addresses. This functionality is replaced using improved multicast addressing capabilities.

IPv6 address types are identified by the high-order bits of the address, as shown in the following table:

Address Type	Binary Prefix	IPv6 Notation
Unspecified	00...0 (128 bits)	::/128
Loopback	00...1 (128 bits)	::1/128
Multicast	11111111	FF00::/8
Link-local unicast	1111111010	FE80::/10
Unique Local IPv6 unicast	11111100	FC00::/7
Global unicast	everything else	

Note that anycast addresses are unicast addresses that are not identifiable by a known prefix.

IPv6 Address Notation

IPv4 addresses are expressed using dotted decimal notation and consist of four eight-bit octets. If this same method was used for IPv6 addresses, the address would contain 16 such octets, thus making it difficult to manage. IPv6 addresses are expressed using *colon hexadecimal notation* and consist of eight 16-bit words, as shown in the following example:

```
1234:000F:531F:4567:0000:0000:BCD2:F34A
```

Note that any field may contain all zeros or all ones. In addition, it is possible to shorten IPv6 addresses by suppressing leading zeros. For example:

```
1234:F:531F:4567:0:0:BCD2:F34A
```

Another method for shortening IPv6 addresses is known as *zero compression*. When an address contains contiguous words that consist of all zeros, a double colon (::) is used to identify these words. For example, using zero compression the address 0:0:0:0:1234:531F:BCD2:F34A is expressed as follows:

```
::1234:531F:BCD2:F34A
```

Because the last four words of the above address are uncompressed values, the double colon indicates that the first four words of the address all contain zeros. Note that using the double colon is only allowed once within a single address. So if the address was 1234:531F:0:0:BCD2:F34A:0:0, a double colon could *not* replace both sets of zeros. For example, the first two versions of this address shown below are valid, but the last version is not valid:

- 1 1234:531F::BCD2:F34A:0:0
- 2 1234:531F:0:0:BCD2:F34A::
- 3 1234:531F::BCD2:F34A:: (not valid)

With IPv6 addresses that have long strings of zeros, the benefit of zero compression is more dramatic. For example, address FF00:0:0:0:0:0:4501:32 becomes FF00::4501:32.

Note that hexadecimal notation used for IPv6 addresses resembles the notation which is used for MAC addresses. However, it is important to remember that IPv6 addresses still identify a device at the Layer 3 level and MAC addresses identify a device at the Layer 2 level.

Another supported IPv6 address notation includes embedding an IPv4 address as the four lower-order bytes of the IPv6 address. This is especially useful when dealing with a mixed IPv4/IPv6 network. For example:

```
0:0:0:0:0:0:212.100.13.6
```

IPv6 Address Prefix Notation

The Classless Inter-Domain Routing (CIDR) notation is used to express IPv6 address prefixes. This notation consists of the 128-bit IPv6 address followed by a slash (/) and a number representing the prefix length (IPv6-address/prefix-length). For example, the following IPv6 address has a prefix length of 64 bits:

```
FE80::2D0:95FF:FE12:FAB2/64
```

Auto-configuration of IPv6 Addresses

This implementation of IPv6 supports the *stateless* auto-configuration of link-local addresses for IPv6 VLAN and tunnel interfaces and for devices when they are connected to the switch. Stateless refers to the fact that little or no configuration is required to generate such addresses and there is no dependency on an address configuration server, such as a DHCP server, to provide the addresses.

A link-local address is a private unicast address that identifies an interface or device on the local network. This type of address allows communication with devices and/or neighboring nodes that are attached to the same physical link. Note that when the communication is between two nodes that are not attached to the same link, both nodes must have a configured global unicast address. Routing between link-local addresses is not available because link-local addresses are not known or advertised to the general network.

When an IPv6 VLAN or a configured tunnel interface is created or a device is connected to the switch, a link-local address is automatically generated for the interface or device. This type of address consists of the well-known IPv6 prefix FE80::/64 combined with an interface ID. The interface ID is derived from the router MAC address associated with the IPv6 interface or the source MAC address if the address is for a device. The resulting link-local address resembles the following example:

```
FE80::2d0:95ff:fe6b:5ccd/64
```

Note that when this example address was created, the MAC address was modified by complementing the second bit of the leftmost byte and by inserting the hex values 0xFF and 0xFE between the third and fourth octets of the address. These modifications were made because IPv6 requires an interface ID that is derived using Modified EUI-64 format.

Stateless auto-configuration is not available for assigning a global unicast or anycast address to an IPv6 interface. In other words, manual configuration is required to assign a non-link-local address to an interface. See [“Assigning IPv6 Addresses” on page 18-17](#) for more information.

Both stateless and *stateful* auto-configuration is supported for devices, such as a workstation, when they are connected to the switch. When the stateless method is used in this instance, the device listens for router advertisements in order to obtain a subnet prefix. The unicast address for the device is then formed by combining the subnet prefix with the interface ID for that device.

Stateful auto-configuration refers to the use of an independent server, such as a DHCP server, to obtain an IPv6 unicast address and other related information. Of course, manual configuration of an IPv6 address is always available for devices as well.

Regardless of how an IPv6 address is obtained, duplicate address detection (DAD) is performed before the address is assigned to an interface or device. If a duplicate is found, the address is not assigned. Note that DAD is *not* performed for anycast addresses, 6to4 tunnels, or VRRP virtual router addresses.

Please refer to RFCs 2462, 2464, and 3513 for more technical information about auto-configuration and IPv6 address notation.

Globally Unique Local IPv6 Unicast Addresses

These addresses are intended to be routable within a limited area, such as a site, but not on the global Internet. Unique Local IPv6 Unicast Addresses are used in conjunction with BGP (IBGP) speakers as well as exterior BGP (EBGP) neighbors based on configured policies. See the BGP chapter of the Advanced Routing Guide for details.

Local IPv6 unicast addresses have the following characteristics:

- Globally unique ID (with high probability of uniqueness).
- Use the well-known prefix FC00::/7 to allow for easy filtering at site boundaries.
- Allow sites to be combined or privately interconnected without creating any address conflicts or requiring renumbering of interfaces that use these prefixes.
- Internet Service Provider independent and can be used for communications inside of a site without having any permanent or intermittent Internet connectivity.
- If accidentally leaked outside of a site through routing or DNS, there is no conflict with any other addresses.
- In practice, applications may treat these addresses like global scoped addresses.

A 40-bit global identifier is used to make the local IPv6 address prefixes globally unique. This global ID can either be explicitly configured, or created using the pseudo-algorithm recommended in RFC 4193.

Tunneling IPv6 over IPv4

It is likely that IPv6 and IPv4 network infrastructures will coexist for some time, if not indefinitely. Tunneling provides a mechanism for transitioning an IPv4 network to IPv6 and/or maintaining interoperability between IPv4 and IPv6 networks. This implementation of IPv6 supports tunneling of IPv6 traffic over IPv4. There are two types of tunnels supported, *6to4* and *configured*.

Note. Dynamic routing protocols are not supported over 6to4 tunnels. However, it is possible to configure dynamic routing for a configured tunnel. See “[Configuring IPv6 Tunnel Interfaces](#)” on page 18-19 for more information.

6to4 Tunnels

6to4 tunneling provides a mechanism for transporting IPv6 host traffic over an IPv4 network infrastructure to other IPv6 hosts and/or domains without having to configure explicit tunnel endpoints. Instead, an IPv6 6to4 tunnel interface is created at points in the network where IPv6 packets are encapsulated (IPv4 header added) prior to transmission over the IPv4 network or decapsulated (IPv4 header stripped) for transmission to an IPv6 destination.

An IPv6 6to4 tunnel interface is identified by its assigned address, which is derived by combining a 6to4 well-known prefix (2002) with a globally unique IPv4 address and embedded as the first 48 bits of an IPv6 address. For example, 2002:d467:8a89::137/64, where d467:8a89 is the hex equivalent of the IPv4 address 212.103.138.137.

6to4 tunnel interfaces are configured on routers and identify a 6to4 site. Because 6to4 tunnels are point-to-multi-point in nature, any one 6to4 router can communicate with one or more other 6to4 routers across the IPv4 cloud. Additionally, IPv6 multicast traffic cannot be forwarded over a 6to4 tunnel. Two common scenarios for using 6to4 tunnels are described below.

6to4 Site to 6to4 Site over IPv4 Domain

In this scenario, isolated IPv6 sites have connectivity over an IPv4 network through 6to4 border routers. An IPv6 6to4 tunnel interface is configured on each border router and assigned an IPv6 address with the 6to4 well-known prefix, as described above. IPv6 hosts serviced by the 6to4 border router have at least one IPv6 router interface configured with a 6to4 address. Note that additional IPv6 interfaces or external IPv6 routing protocols are not required on the 6to4 border router.

The following diagram illustrates the basic traffic flow between IPv6 hosts communicating over an IPv4 domain:

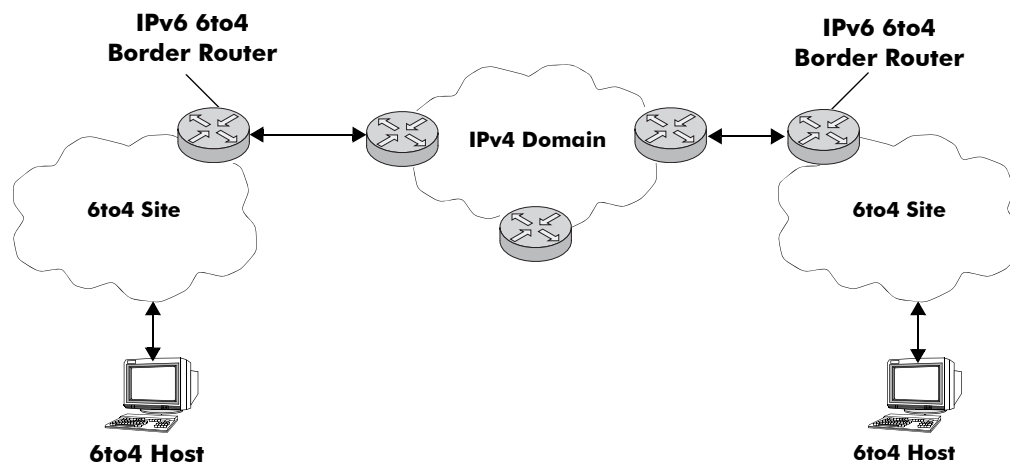

In the above diagram:

- 1 The 6to4 hosts receive 6to4 prefix from Router Advertisement.
- 2 The 6to4 host sends IPv6 packets to 6to4 border router.
- 3 The 6to4 border router encapsulates IPv6 packets with IPv4 headers and sends to the destination 6to4 border router over the IPv4 domain.
- 4 The destination 6to4 border router strips IPv4 header and forwards to 6to4 destination host.

6to4 Site to IPv6 Site over IPv4/IPv6 Domains

In this scenario, 6to4 sites have connectivity to native IPv6 domains through a relay router, which is connected to both the IPv4 and IPv6 domains. The 6to4 border routers are still used by 6to4 sites for encapsulating/decapsulating host traffic and providing connectivity across the IPv4 domain. In addition, each border router has a default IPv6 route pointing to the relay router.

In essence, a relay router is a 6to4 border router on which a 6to4 tunnel interface is configured. However, a native IPv6 router interface is also required on the relay router to transmit 6to4 traffic to/from IPv6 hosts connected to an IPv6 domain. Therefore, the relay router participates in both the IPv4 and IPv6 routing domains.

The following diagram illustrates the basic traffic flow between native IPv6 hosts and 6to4 sites:

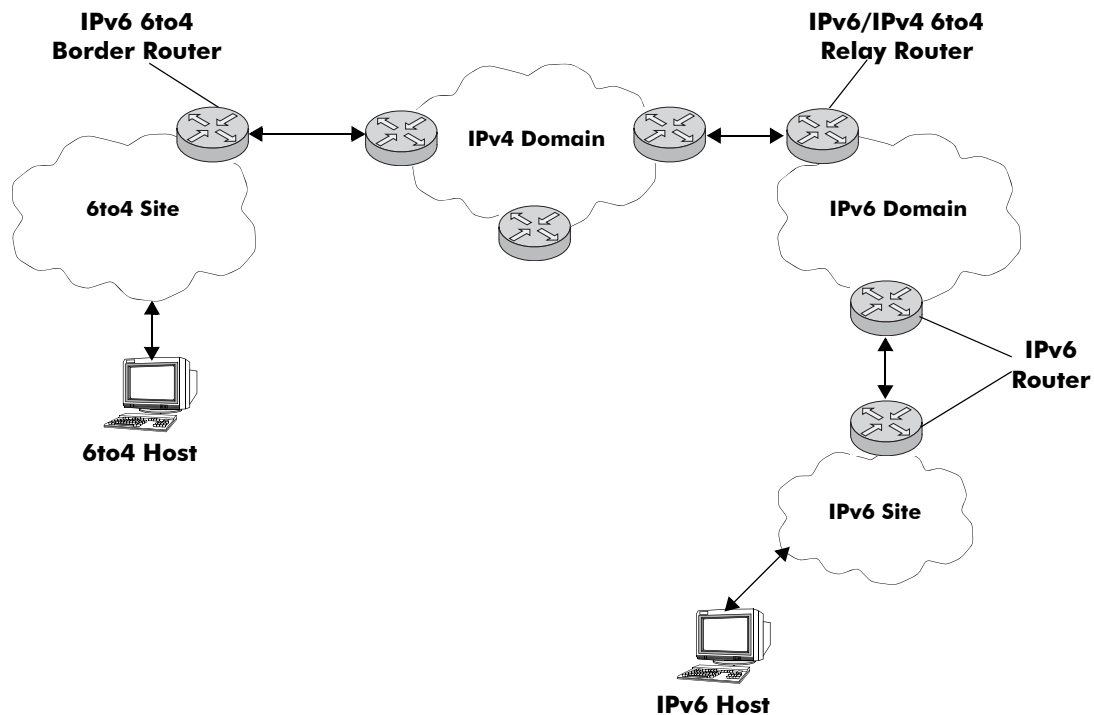

In the above diagram:

- 1 The 6to4 relay router advertises a route to 2002::/16 on its IPv6 router interface.
- 2 The IPv6 host traffic received by the relay router that has a next hop address that matches 2002::/16 is routed to the 6to4 tunnel interface configured on the relay router.
- 3 The traffic routed to the 6to4 tunnel interface is then encapsulated into IPv4 headers and sent to the

destination 6to4 router over the IPv4 domain.

- 4 The destination 6to4 router strips the IPv4 header and forwards it to the IPv6 destination host.

For more information about configuring an IPv6 6to4 tunnel interface, see [“Configuring an IPv6 Interface” on page 18-15](#) and [“Configuring IPv6 Tunnel Interfaces” on page 18-19](#). For more detailed information and scenarios by using 6to4 tunnels, refer to RFC 3056.

Configured Tunnels

A configured tunnel is where the endpoint addresses are manually configured to create a point-to-point tunnel. This type of tunnel is similar to the 6to4 tunnel on which IPv6 packets are encapsulated in IPv4 headers to facilitate communication over an IPv4 network. The difference between the two types of tunnels is that configured tunnel endpoints require manual configuration, whereas 6to4 tunneling relies on an embedded IPv4 destination address to identify tunnel endpoints. Additionally, IPv6 multicast traffic can be sent over configured tunnels allows RIPng and OSPFv3 to run over a configured tunnel.

For more information about IPv6 configured tunnels, see [“Configuring IPv6 Tunnel Interfaces” on page 18-19](#). For more detailed information about configured tunnels, refer to RFC 4213.

Local Proxy Neighbor Discovery (LPND)

Local Proxy Neighbor Discovery (LPND) is used to isolate IPv6 nodes on the same VLAN from each other. If LPND is enabled on an IPv6 VLAN interface, a client will not learn the MAC address of any other IPv6 node reached via the switch. The switch will intercept all neighbor discovery messages and replace the client MACs with the switches MAC before sending the messages to their destination. As a result, all IPv6 traffic will be routed, not switched. See [“Configuring LPND” on page 18-27](#) for more information.

Router Advertisement (RA) Filtering

RA filtering can be used to prevent the spread of rogue RAs from unauthorized systems. If enabled on an interface, any received RAs will be dropped without being forwarded on to any other connected IPv6 clients.

One or more trusted ports or linkaggs can be specified for an interface. RAs received on those trusted ports or linkaggs will be allowed to continue on to all other IPv6 clients reached via the interface. See [“Configuring RA Filtering” on page 18-29](#) for more information.

Neighbor Cache Limit

The size of the neighbor cache can be limited on a system-wide basis. Once the limit is reached, no new entries will be added. The system-wide limit can be used to control the resources allocated for the IPv6 neighbor cache.

A neighbor cache limit may also be specified on a per-interface basis. Once the interface's limit is reached, no new neighbor entries are allowed. The per-interface limit can be used to prevent any particular node attached to an interface from flooding the cache, either maliciously or due to a malfunction.

By default, no limits are set (System, VRF or Interface). See [“Configuring Neighbor Cache Limit” on page 18-27](#) for more information.

Neighbor Unreachability Detection (NUD)

IPv6 Neighbor Unreachability Detection (NUD) is performed to check the status of an unconfirmed neighbor when traffic is forwarded to it. By default, up to three neighbor solicitations are sent, with an interval of one second, to reconfirm that the neighbor is reachable.

In certain situations (e.g. high traffic loads), the default settings may not be sufficient to maintain the neighbor cache in a stable state. In such situations both the maximum number of neighbor solicitations and the interval at which they are sent may be modified. See [“Configuring NUD” on page 18-28](#) for more information.

Configuring an IPv6 Interface

The **ipv6 interface** command is used to create an IPv6 interface for a VLAN or a tunnel. Note the following when configuring an IPv6 interface:

- A unique interface name is required for both a VLAN and tunnel interface.
- If creating a VLAN interface, the VLAN must already exist. See [Chapter 4, “Configuring VLANs,”](#) for more information.
- If creating a tunnel interface, a tunnel ID or **6to4** is specified. Only one 6to4 tunnel is allowed per switch, so it is not necessary to specify an ID when creating this type of tunnel.
- If a tunnel ID is specified, then a configured tunnel interface is created. This type of tunnel requires additional configuration by using the **ipv6 address global-id** command. See [“Configuring IPv6 Tunnel Interfaces” on page 18-19](#) for more information.
- Each VLAN can have one IPv6 interface. Configuring both an IPv4 and IPv6 interface on the same VLAN is allowed. Note that the VLAN interfaces of both types are not active until at least one port associated with the VLAN goes active.
- A link-local address is automatically configured for an IPv6 interface, except for 6to4 tunnels, when the interface is configured. For more information regarding how this address is formed, see [“Auto-configuration of IPv6 Addresses” on page 18-9](#).
- Assigning more than one IPv6 address to a single IPv6 interface is allowed.
- Assigning the same link-local address to multiple interfaces is allowed. Each global unicast prefix, subset of, or superset of a prefix can only exist on one interface. For example, if an interface for VLAN 100 is configured with an address 2001:db8:4100:1000::1/64, an interface for VLAN 200 cannot have an address 2001:db8:4100:1000::2/64.
- Each IPv6 interface anycast address must also have a unique prefix. However, multiple devices may share the same anycast address prefix to identify themselves as members of the anycast group.

To create an IPv6 interface for a VLAN or configured tunnel, enter **ipv6 interface** followed by an interface name, then **vlan** (or **tunnel**) followed by a VLAN ID (or tunnel ID). For example, the following two commands create an IPv6 interface for VLAN 200 and an interface for tunnel 35:

```
-> ipv6 interface v6if-v200 vlan 200
-> ipv6 interface v6if-tunnel-35 tunnel 35
```

To create an IPv6 interface for a 6to4 tunnel, use the following command:

```
-> ipv6 interface v6if-6to4 tunnel 6to4
```

Note. A 6to4 tunnel is automatically created at startup.

Use the **show ipv6 interface** command to verify the interface configuration for the switch. For more information about this command, see the *OmniSwitch AOS Release 8 CLI Reference Guide*.

Configuring a Unique Local IPv6 Unicast Address

The **ipv6 address global-id** command is used to create a new value for the global ID. A 5-byte global ID value can be manually specified or automatically generated:

```
-> ipv6 address global-id generate
-> ipv6 address global-id 32:57a3:8fed
```

Note. If the global-id has not previously been specified with the commands above it will automatically be generated when the first IPv6 local-unicast address command is issued.

Once the global ID is generated the **ipv6 address local-unicast** command can be used to generate a unique local address using the configured global-id.

Modifying an IPv6 Interface

The **ipv6 interface** command is also used to modify existing IPv6 interface parameter values. It is not necessary to first remove the interface and then create it again with the new values. The changes specified will overwrite existing parameter values. For example, the following command changes the router advertisement (RA) reachable time and the RA retransmit timer values for interface *v6if-v200*:

```
-> ipv6 interface v6if-v200 ra-reachable-time 60000 ra-retrans-time 2000
```

When an existing interface name is specified with the **ipv6 interface** command, the command modifies specified parameters for that interface. If an unknown interface name is entered along with an existing VLAN or tunnel parameter, a new interface is created with the name specified.

Removing an IPv6 Interface

To remove an IPv6 interface from the switch configuration, use the **no** form of the **ipv6 interface** command. Note that it is only necessary to specify the name of the interface, as shown in the following example:

```
-> no ipv6 interface v6if-v200
```

Assigning IPv6 Addresses

As was previously mentioned, when an IPv6 interface is created for a VLAN or a configured tunnel, an IPv6 link-local address is automatically created for that interface. This is also true when a device, such as a workstation, is connected to the switch.

Link-local addresses, although private and non-routable, enable interfaces and workstations to communicate with other interfaces and workstations that are connected to the same link. This simplifies getting devices up and running on the local network. If this level of communication is sufficient, assigning additional addresses is not required.

If it is necessary to identify an interface or device to the entire network, or as a member of a particular group, or enable an interface to perform routing functions, then configuring additional addresses (for example, global unicast or anycast) is required.

Use the **ipv6 address** command to manually assign addresses to an existing interface (VLAN or tunnel) or device. For example, the following command assigns a global unicast address to the VLAN interface “v6if-v200”:

```
-> ipv6 address 2001:db8:4100:1000::20/64 v6if-v200
```

In the above example, 2001:db8:4100:1000:: is specified as the subnet prefix and 20 is the interface identifier. Note that the IPv6 address is expressed using CIDR notation to specify the prefix length. In the above example, /64 indicates a subnet prefix length of 64 bits.

To use the MAC address of an interface or device as the interface ID, specify the **eui-64** option with this command. For example:

```
-> ipv6 address 2001:db8:4100:1000::/64 eui-64 v6if-v200
```

The above command example creates address 2001:db8:4100:1000::2d0:95ff:fe12:fab2/64 for interface v6if-v200.

Note the following when configuring IPv6 addresses:

- It is possible to assign more than one address to a single interface.
- Any field of an address may contain all zeros or all ones. The exception to this is the interface identifier portion of the address, which cannot be all zeros. If the **eui-64** option is specified with the **ipv6 address** command, this is not an issue.
- The EUI-64 interface identifier takes up the last 64 bits of the 128-bit IPv6 address. If the subnet prefix combined with the EUI-64 interface ID is longer than 128 bits, an error occurs and the address is not created.

A subnet router anycast address is automatically created when a global unicast address is assigned to an interface. The anycast address is derived from the global address by adding an interface ID of all zeros to the prefix of the global address. For example, the global address 2001:db8:4100:1000::20/64 generates the anycast address 2001:db8:4100:1000::/64.

- Devices, such as a PC, are eligible for stateless auto-configuration of unicast addresses in addition to the link-local address. If this type of configuration is in use on the network, manual configuration of addresses on the PC is not required.
- IPv6 VLAN or tunnel interfaces are only eligible for stateless auto-configuration of their link-local addresses. Manual configuration of addresses is required for all additional addresses.

See [“IPv6 Addressing” on page 18-7](#) for an overview of IPv6 address notation. Refer to RFC 4291 for more technical address information.

Removing an IPv6 Address

To remove an IPv6 address from an interface, use the **no** form of the **ipv6 address** command as shown:

```
-> no ipv6 address 2001:db8:4100:1000::20 v6if-v200
```

Note that the subnet router anycast address is automatically deleted when the last unicast address of the same subnet is removed from the interface.

Configuring IPv6 Tunnel Interfaces

There are two types of tunnels supported, 6to4 and configured. Both types facilitate the interaction of IPv6 networks with IPv4 networks by providing a mechanism for carrying IPv6 traffic over an IPv4 network infrastructure. This is an important function since it is more than likely that both protocols will need to coexist within the same network for some time.

A 6to4 tunnel is configured by creating an IPv6 6to4 tunnel interface on a router. This interface is then assigned an IPv6 address with an embedded well-known 6to4 prefix (for example, 2002) combined with an IPv4 local address. This is all done using the **ipv6 interface** and **ipv6 address** commands. Since a 6to4 interface named “tunnel_6to4” is automatically created, enter the following commands to create a 6to4 tunnel interface:

```
-> ipv6 address 2002:c633:6489::254/16 tunnel_6to4
-> ipv6 interface tunnel_6to4 admin-state enable
```

In the above example, 2002 is the well-known prefix that identifies a 6to4 tunnel. The C633:6489 part of the address that follows 2002 is the hex equivalent of the IPv4 address 198.51.100.137. Note that an IPv4 interface configured with the embedded IPv4 address is required on the switch. In addition, do not configure a private (for example, 192.168.10.1), broadcast, or unspecified address as the embedded IPv4 address.

One of the main benefits of 6to4 tunneling is that no other configuration is required to identify tunnel endpoints. The router that the 6to4 tunnel interface is configured on will encapsulate IPv6 packets in IPv4 headers and send them to the IPv4 destination address where they will be processed. This is particularly useful in situations where the IPv6 host is isolated.

The second type of tunnel supported is referred to as a configured tunnel. With this type of tunnel it is necessary to specify an IPv4 address for the source and destination tunnel endpoints. Note that if bidirectional communication is desired, then it is also necessary to create the tunnel interface at each end of the tunnel.

Creating an IPv6 configured tunnel involves the following general steps:

- Create an IPv6 tunnel interface using the **ipv6 interface** command.
- Associate an IPv4 source and destination address with the tunnel interface by using the **ipv6 interface** command. These addresses identify the tunnel endpoints.
- Associate an IPv6 address with the tunnel interface by using the **ipv6 address** command.
- Configure a tunnel interface and associated addresses at the other end of tunnel.

The following example commands create the *v6if-tunnel-137* configured tunnel:

```
-> ipv6 interface v6if-tunnel-137 tunnel 1
-> ipv6 interface v6if-tunnel-137 tunnel source 198.51.100.137 destination
192.0.2.195
-> ipv6 address 2100:db8:4132:4000::/64 eui-64 v6if-tunnel-137
-> ipv6 interface v6if-tunnel-137 admin-state enable
```

Note that dynamic routing protocols are not supported over 6to4 tunnels, but are allowed over configured tunnels. To use this protocol on a configured tunnel, a dynamic routing protocol interface is created for the tunnel interface. For example, the following command creates a RIPng interface for tunnel v6if-tunnel-137:

```
-> ipv6 rip interface v6if-tunnel-137
```

Creating an IPv6 Static Route

Static routes are user-defined and carry a higher priority than routes created by dynamic routing protocols. That is, if two routes have the same metric value, the static route has the higher priority. Static routes allow you to define, or customize, an explicit path to an IPv6 network segment, which is then added to the IPv6 Forwarding table. Static routes can be created between VLANs to enable devices on these VLANs to communicate.

Use the **ipv6 static-route** command to create a static route. You must specify the destination IPv6 address of the route as well as the IPv6 address of the first hop (gateway) used to reach the destination. For example, to create a static route to IPv6 address 212:95:5::/64 through gateway fe80::2d0:95ff:fe6a:f458 on interface v6if-137, you would enter:

```
-> ipv6 static-route 2001:db8:212:95::/64 gateway fe80::2d0:95ff:fe6a:f458 v6if-137
```

Note that in the example above the IPv6 interface name for the gateway was included. This parameter is required only when a link local address is specified as the gateway.

When you create a static route, the default metric value of 1 is used. However, you can change the priority of the route by increasing its metric value. The lower the metric value, the higher the priority. This metric is added to the metric cost of the route. The metric range is 1 to 15. For example:

```
-> ipv6 static-route 2001:db8:212:95::/64 gateway fe80::2d0:95ff:fe6a:f458 v6if-137
metric 3
```

Static routes do not age out of the IPv6 Forwarding table; you must delete them from the table. Use the **no ipv6 static-route** command to delete a static route. You must specify the destination IPv6 address of the route as well as the IPv6 address of the first hop (gateway). For example, to delete the static you would enter:

```
-> no ip static-route 2001:db8:212:95::/64 gateway fe80::2d0:95ff:fe6a:f458 v6if-137
```

The IPv6 Forwarding table includes routes learned through one of the routing protocols (RIP, OSPF, BGP) as well as any static routes that are configured. Use the **show ipv6 routes** command to display the IPv6 Forwarding table.

Note. A static route is not active unless the gateway it is using is active.

Configuring the Route Preference of a Router

By default, the route preference of a router is in this order: local, static, OSPFv3, RIPng, EBGp, and IBGP (highest to lowest).

Use the **ipv6 route-pref** command to change the route preference value of a router. For example, to configure the route preference of an OSPF route, you would enter:

```
-> ipv6 route-pref ospf 15
```

To display the current route preference configuration, use the **show ipv6 route-pref** command:

```
-> show ipv6 route-pref
  Protocol      Route Preference Value
-----+-----
  Local         1
  Static        2
  OSPF          110
  RIP           120
  EBGp          190
  IBGP          200
```

Configuring Route Map Redistribution

It is possible to learn and advertise IPv6 routes between different protocols. Such a process is referred to as route redistribution and is configured using the **ipv6 redistrib** command.

Redistribution uses route maps to control how external routes are learned and distributed. A route map consists of one or more user-defined statements that can determine which routes are allowed or denied access to the receiving network. In addition a route map may also contain statements that modify route parameters before they are redistributed.

When a route map is created, it is given a name to identify the group of statements that it represents. This name is required by the **ipv6 redistrib** command. Therefore, configuring route redistribution involves the following steps:

- 1 Create a route map, as described in [“Using Route Maps” on page 18-22](#).
- 2 Configure redistribution to apply a route map, as described in [“Configuring Route Map Redistribution” on page 18-26](#).

Using Route Maps

A route map specifies the criteria that are used to control redistribution of routes between protocols. Such criteria is defined by configuring route map statements. There are three different types of statements:

- **Action.** An action statement configures the route map name, sequence number, and whether or not redistribution is permitted or denied based on route map criteria.
- **Match.** A match statement specifies criteria that a route must match. When a match occurs, then the action statement is applied to the route.
- **Set.** A set statement is used to modify route information before the route is redistributed into the receiving protocol. This statement is only applied if all the criteria of the route map is met and the action permits redistribution.

The **ip route-map** command is used to configure route map statements and provides the following **action**, **match**, and **set** parameters:

ip route-map action ...	ip route-map match ...	ip route-map set ...
permit deny	ip-address ip-nexthop ipv6-address ipv6-nexthop tag ipv4-interface ipv6-interface metric route-type	metric metric-type tag community local-preference level ip-nexthop ipv6-nexthop

Refer to the “IP Commands” chapter in the *OmniSwitch AOS Release 8 CLI Reference Guide* for more information about the **ip route-map** command parameters and usage guidelines.

Once a route map is created, it is then applied using the **ipv6 redistrib** command. See [“Configuring Route Map Redistribution” on page 18-26](#) for more information.

Creating a Route Map

When a route map is created, it is given a name (up to 20 characters), a sequence number, and an action (permit or deny). Specifying a sequence number is optional. If a value is not configured, then the number 50 is used by default.

To create a route map, use the **ip route-map** command with the **action** parameter. For example,

```
-> ip route-map ospf-to-rip sequence-number 10 action permit
```

The above command creates the ospf-to-rip route map, assigns a **sequence number** of 10 to the route map, and specifies a **permit** action.

To optionally filter routes before redistribution, use the **ip route-map** command with a **match** parameter to configure match criteria for incoming routes. For example,

```
-> ip route-map ospf-to-rip sequence-number 10 match tag 8
```

The above command configures a match statement for the ospf-to-rip route map to filter routes based on their tag value. When this route map is applied, only OSPF routes with a tag value of eight are redistributed into the RIP network. All other routes with a different tag value are dropped.

Note. Configuring match statements is not required. However, if a route map does not contain any match statements and the route map is applied using the **ipv6 redist** command, the router redistributes *all* routes into the network of the receiving protocol.

To modify route information before it is redistributed, use the **ip route-map** command with a **set** parameter. For example,

```
-> ip route-map ospf-to-rip sequence-number 10 set tag 5
```

The above command configures a set statement for the ospf-to-rip route map that changes the route tag value to five. Because this statement is part of the ospf-to-rip route map, it is only applied to routes that have an existing tag value equal to eight.

The following is a summary of the commands used in the above examples:

```
-> ip route-map ospf-to-rip sequence-number 10 action permit
-> ip route-map ospf-to-rip sequence-number 10 match tag 8
-> ip route-map ospf-to-rip sequence-number 10 set tag 5
```

To verify a route map configuration, use the **show ip route-map** command:

```
-> show ip route-map
Route Maps: configured: 1 max: 200
Route Map: ospf-to-rip Sequence Number: 10 Action permit
  match tag 8
  set tag 5
```

Deleting a Route Map

Use the **no** form of the **ip route-map** command to delete an entire route map, a route map sequence, or a specific statement within a sequence.

To delete an entire route map, enter **no ip route-map** followed by the route map name. For example, the following command deletes the entire route map named `redistipv4`:

```
-> no ip route-map redistipv4
```

To delete a specific sequence number within a route map, enter **no ip route-map** followed by the route map name, then **sequence-number** followed by the actual number. For example, the following command deletes sequence 10 from the `redistipv4` route map:

```
-> no ip route-map redistipv4 sequence-number 10
```

Note that in the above example, the `redistipv4` route map is not deleted. Only those statements associated with sequence 10 are removed from the route map.

To delete a specific statement within a route map, enter **no ip route-map** followed by the route map name, then **sequence-number** followed by the sequence number for the statement, then either **match** or **set** and the match or set parameter and value. For example, the following command deletes only the match tag 8 statement from route map `redistipv4` sequence 10:

```
-> no ip route-map redistipv4 sequence-number 10 match tag 8
```

Configuring Route Map Sequences

A route map may consist of one or more sequences of statements. The sequence number determines which statements belong to which sequence and the order in which sequences for the same route map are processed.

To add match and set statements to an existing route map sequence, specify the same route map name and sequence number for each statement. For example, the following series of commands creates route map `rm_1` and configures match and set statements for the `rm_1` sequence 10:

```
-> ip route-map rm_1 sequence-number 10 action permit
-> ip route-map rm_1 sequence-number 10 match tag 8
-> ip route-map rm_1 sequence-number 10 set metric 1
```

To configure a new sequence of statements for an existing route map, specify the same route map name but use a different sequence number. For example, the following command creates a new sequence 20 for the `rm_1` route map:

```
-> ip route-map rm_1 sequence-number 20 action permit
-> ip route-map rm_1 sequence-number 20 match ipv4-interface to-finance
-> ip route-map rm_1 sequence-number 20 set metric 5
```

The resulting route map appears as follows:

```
-> show ip route-map rm_1
Route Map: rm_1 Sequence Number: 10 Action permit
  match tag 8
  set metric 1
Route Map: rm_1 Sequence Number: 20 Action permit
  match ipv4 interface to-finance
  set metric 5
```

Sequence 10 and sequence 20 are both linked to route map `rm_1` and are processed in ascending order according to their sequence number value. Note that there is an implied logical OR between sequences. As a result, if there is no match for the tag value in sequence 10, then the match interface statement in sequence 20 is processed. However, if a route matches the tag 8 value, then sequence 20 is not used. The set statement for whichever sequence was matched is applied.

A route map sequence may contain multiple match statements. If these statements are of the same kind (for example, match tag 5, match tag 8, etc.) then a logical OR is implied between each like statement. If the match statements specify different types of matches (for example match tag 5, match ip4 interface to-finance, etc.), then a logical AND is implied between each statement. For example, the following route map sequence will redistribute a route if its tag is either 8 or 5:

```
-> ip route-map rm_1 sequence-number 10 action permit
-> ip route-map rm_1 sequence-number 10 match tag 5
-> ip route-map rm_1 sequence-number 10 match tag 8
```

The following route map sequence will redistribute a route if the route has a tag of 8 or 5 *and* the route was learned on the IPv6 interface to-finance:

```
-> ip route-map rm_1 sequence-number 10 action permit
-> ip route-map rm_1 sequence-number 10 match tag 5
-> ip route-map rm_1 sequence-number 10 match tag 8
-> ip route-map rm_1 sequence-number 10 match ipv6-interface to-finance
```

Configuring Access Lists

An IP access list provides a convenient way to add multiple IPv4 or IPv6 addresses to a route map. Using an access list avoids having to enter a separate route map statement for each individual IP address. Instead, a single statement is used that specifies the access list name. The route map is then applied to all the addresses contained within the access list.

Configuring an IP access list involves two steps: creating the access list and adding IP addresses to the list. To create an IP access list, use the **ip access-list** command (IPv4) or the **ipv6 access-list** command (IPv6) and specify a name to associate with the list. For example,

```
-> ip access-list ipaddr
-> ipv6 access-list ip6addr
```

To add addresses to an access list, use the **ip access-list address** (IPv4) or the **ipv6 access-list address** (IPv6) command. For example, the following commands add addresses to an existing access list:

```
-> ip access-list ipaddr address 10.0.0.0/8
-> ipv6 access-list ip6addr address 2001::/64
```

Use the same access list name each time the above commands are used to add additional addresses to the same access list. In addition, both commands provide the ability to configure if an address and/or its matching subnet routes are permitted (the default) or denied redistribution. For example:

```
-> ip access-list ipaddr address 16.24.2.1/16 action deny redistrib-control all-
subnets
-> ipv6 access-list ip6addr address 2001::1/64 action permit redistrib-control no-
subnets
```

For more information about configuring access list commands, see the “IP Commands” chapter in the *OmniSwitch AOS Release 8 CLI Reference Guide*.

Configuring Route Map Redistribution

The **ipv6 redistrib** command is used to configure the redistribution of routes from a source protocol into the destination protocol. This command is used on the IPv6 router that will perform the redistribution.

Note. A router automatically becomes an Autonomous System Border Router (ASBR) when redistribution is configured on the router.

A source protocol is a protocol from which the routes are learned. A destination protocol is the one into which the routes are redistributed. Make sure that both protocols are loaded and enabled before configuring redistribution.

Redistribution applies criteria specified in a route map to routes received from the source protocol. Therefore, configuring redistribution requires an existing route map. For example, the following command configures the redistribution of OSPFv3 routes into the RIPng network using the ospf-to-rip route map:

```
-> ipv6 redistrib ospf into rip route-map ospf-to-rip
```

OSPFv3 routes received by the router interface are processed based on the contents of the ospf-to-rip route map. Routes that match criteria specified in this route map are either allowed or denied redistribution into the RIPng network. The route map may also specify the modification of route information before the route is redistributed. See [“Using Route Maps” on page 18-22](#) for more information.

To remove a route map redistribution configuration, use the **no** form of the **ipv6 redistrib** command. For example:

```
-> no ipv6 redistrib ospf into rip route-map ospf-to-rip
```

Use the **show ipv6 redistrib** command to verify the redistribution configuration:

```
-> show ipv6 redistrib
```

Source Protocol	Destination Protocol	Status	Route Map
localIPv6	RIPng	Enabled	ipv6rm
OSPFv3	RIPng	Enabled	ospf-to-rip

Configuring the Administrative Status of the Route Map Redistribution

The administrative status of a route map redistribution configuration is enabled by default. To change the administrative status, use the **admin-state** parameter with the **ipv6 redistrib** command. For example, the following command disables the redistribution administrative status for the specified route map:

```
-> ipv6 redistrib ospf into rip route-map ospf-to-rip admin-state disable
```

The following command example enables the administrative status:

```
-> ipv6 redistrib ospf into rip route-map ospf-to-rip admin-state enable
```

Route Map Redistribution Example

The following example configures the redistribution of OSPFv3 routes into a RIPng network using a route map (ospf-to-rip) to filter specific routes:

```
-> ip route-map ospf-to-rip sequence-number 10 action deny
-> ip route-map ospf-to-rip sequence-number 10 match tag 5
-> ip route-map ospf-to-rip sequence-number 10 match route-type external type2
-> ip route-map ospf-to-rip sequence-number 20 action permit
-> ip route-map ospf-to-rip sequence-number 20 match ipv6-interface intf_ospf
-> ip route-map ospf-to-rip sequence-number 20 set metric 255

-> ip route-map ospf-to-rip sequence-number 30 action permit
-> ip route-map ospf-to-rip sequence-number 30 set tag 8

-> ip redist ospf into rip route-map ospf-to-rip
```

The resulting ospf-to-rip route map redistribution configuration does the following:

- Denies the redistribution of Type 2 external OSPFv3 routes with a tag set to five.
- Redistributes into RIPng all routes learned on the intf_ospf interface and sets the metric for such routes to 255.
- Redistributes into RIPng all other routes (those not processed by sequence 10 or 20) and sets the tag for such routes to eight.

Configuring LPND

To enable LPND, use the command **ipv6 interface** with the parameter **local-proxy-nd**. For example, the following command enables the LPND on the “vlan_1” IPv6 interface:

```
-> ipv6 interface vlan_1 local-proxy-nd
```

To disable LPND, use the **no** form of the **ipv6 interface** command. For example, the following command disables the LPND on the “vlan_1” IPv6 interface:

```
-> ipv6 interface vlan_1 no local-proxy-nd
```

Configuring Neighbor Cache Limit

To set the system-wide cache limit, use the **ipv6 neighbor limit** command. For example, the following command sets the system-wide cache limit to 9000 entries:

```
-> ipv6 neighbor limit 9000
```

To set the per-interface limit, use the **ipv6 interface** commands ‘neighbor limit’ option. For example, the following command sets the “vlan_1” interface limit to 100 entries:

```
-> ipv6 interface vlan_1 neighbor-limit 100
```

Note. To view the information on IPV6 cache limit, use the **show ipv6 information** command.

Configuring NUD

To specify the maximum number of neighbor solicitations to be sent during the NUD process, use the **ipv6 interface** command with the **retrans-max** parameter. For example:

```
-> ipv6 interface vlan_1 retrans-max 5
```

This example sets the maximum number of neighbor solicitations to 5 for the “vlan_1” interface.

To modify the fixed interval at which the neighbor solicitations are sent during the NUD process, use the **ipv6 interface** command with **retrans-timer** parameter. For example:

```
-> ipv6 interface vlan_1 retrans-timer 3000
```

This example sets the interval between neighbor solicitations to 3 seconds (3000 ms) for the “vlan_1” interface.

To enable using an exponentially increasing interval between the neighbor solicitations sent during the NUD process, use the **ipv6 interface** command with **retrans-backoff** parameter. The interval between subsequent neighbor solicitations will be calculated using the formula, $NS\ interval = ib^n$, where,

i = the retransmit interval (retrans-timer)

b = the retransmit backoff (retrans-backoff)

n = the current neighbor solicitation number (starting at 0 for the first transmit)

For example:

```
-> ipv6 interface vlan_1 retrans-max 5 retrans-timer 1000 retrans-backoff 3
```

This example results in up to 5 neighbor solicitations being sent during the NUD process with intervals of 1, 3, 9, and 27 seconds.

Note. The **retrans-max** and **retrans-timer** options also affect neighbor solicitations sent during the initial neighbor discovery process when attempting to resolve a new address. However, the exponential backoff (retrans-backoff) does not apply to initial neighbor discovery.

Configuring RA Filtering

To enable RA filtering on an interface, use the **ipv6 ra-filter** command. For example:

```
-> ipv6 ra-filter vlan-3
```

This example enables RA filtering on the “vlan-3” interface. All RAs received on the interface will be dropped.

To specify a trusted port, use the **ipv6 ra-filter** command with the **trusted-port** option. For example:

```
-> ipv6 ra-filter vlan-3 trusted-port 1/1/22
```

This specifies that port 1/1/22 is trusted on the “vlan-3” interface. RAs received on this port will be forwarded to all other clients connected to the interface. RAs received on any other port will still be dropped.

To remove a trusted port use the following command:

```
-> no ipv6 ra-filter vlan-3 trusted-port linkagg 2
```

This will remove linkagg 2 as a trusted port on the “vlan-3” interface.

To disable RA filtering on an interface, use the **no ipv6 ra-filter** command. For example:

```
-> no ipv6 ra-filter vlan-3
```

This disables RA filtering on the vlan-3 interface.

Note. To view the RA filter configuration for an ipv6 interface, use the **show ipv6 ra-filter** command.

Quick Steps for Configuring DHCPv6 Relay

To configure the DHCPv6 relay feature proceed as follows:

1 Enable the DHCPv6 relay service on the switch using the **ipv6 dhcp relay admin-state** command. For example:

```
-> ipv6 dhcp relay admin-state enable
```

Note. Though the DHCPv6 relay is enabled on the switch it has to be explicitly enabled on the interface, for the DHCPv6 client messages to be relayed.

2 Configure the interface for the DHCPv6 relay using the **ipv6 dhcp relay interface admin-state** command. For example:

```
-> ipv6 dhcp relay int1 admin-state enable
```

Note. At least one relay destination should be configured before enabling the DHCPv6 relay on an interface.

3 Configure the DHCPv6 relay destination using the **ipv6 dhcp relay destination** command. For example the following command configures the DHCPv6 relay destination for the “int1” interface:

```
-> ipv6 dhcp relay int1 destination 3001::3
```

Note. A maximum of five destinations can be configured for an interface. If the relay destination is a local-link then the interface name for the local-link should be specified. For example:

```
-> ipv6 dhcp relay int1 destination fe80::64 int1
```

DHCPv6 Relay Overview

The Alcatel-Lucent OmniSwitch implementation of RFC 3315 contains IPv6 support. A DHCPv6 relay agent is required in situations where DHCPv6 clients do not reside on the same link as the DHCP server. The DHCPv6 Relay on OmniSwitch processes and forwards all DHCPv6 messages triggered by DHCPv6 client to the configured DHCPv6 relay agent as a unicast packet.

DHCPv6 Relay is a per-interface option that can be enabled on any IPv6 interface.

For details on how DHCPv6 Relay and configuration is implemented on OmniSwitch, see the following sections.

DHCPv6 Relay Interface

The DHCPv6 relay can operate in multiple VRFs (IPv6 multi-VRF). It supports multicast-capable IPv6 interfaces (VLAN and configured tunnel interfaces) and non-multicast-capable IPv6 interfaces (6to4 tunnel).

The DHCPv6 Relay agent shall be part of the link-scoped multicast group (FF02::1:2) on the interface. Any messages sent by a client to that address will then be handled by DHCPv6 Relay agent.

A maximum of five unicast or link-scoped multicast relay destinations can be configured for each interface on which DHCPv6 Relay is enabled. The DHCPv6 relay for the interface will be automatically disabled when all the relay destinations configured for that interface is removed.

DHCPv6 Relay Messages

Relay-Forward Messages

When the DHCPv6 relay agent receives the relay-forward message, it will verify the hop-count of the message. If the hop-count value is greater or equal to the hop-count limit (32) the message will be discarded and a new relay-forward message is created else the message is forwarded to the relay destination.

Relay-Reply Messages

When the DHCPv6 relay agent connected to the client receives the relay-reply message, it verifies if the DHCPv6 relay is enabled or disabled on the interface identified by the address in the link-address field. If the DHCPv6 relay is disabled, the message is discarded. If the DHCPv6 relay is enabled then the DHCPv6 message is extracted and sent to the address contained in the relay-reply message.

Configuring DHCPv6 Relay

The following sections provide information about how to configure DHCPv6 Relay on the switch.

Enabling the DHCPv6 Relay Per-VRF

The DHCPv6 relay can operate in multiple VRFs (IPv6 multi-VRF). To enable the DHCPv6 relay on the VRF use the `ipv6 dhcp relay admin-state` command. For example:

```
-> ipv6 dhcp relay admin-state enable
```

Note. Even though the DHCPv6 relay is enabled on the switch, it has to be explicitly enabled on the IPv6 interface for the DHCPv6 client messages to be relayed.

Configuring the DHCPv6 Relay Interface

An interface should be configured to relay the DHCPv6 messages received from the client. To configure the interface use the `ipv6 dhcp relay interface admin-state` command. For example:

```
-> ipv6 dhcp relay int1 admin-state enable
```

Note. At least one relay destination should be configured before enabling DHCPv6 relay on an interface.

Configuring the DHCPv6 Relay Destination

The DHCPv6 relay enabled interface should be configured with the relay destination (DHCP server) to which the DHCPv6 client messages are to be relayed. To configure the relay destination use the `ipv6 dhcp relay destination` command. For example:

```
-> ipv6 dhcp relay int1 destination 3001::3
```

Note. If the relay destination is a local-link then the interface-ID of the local-link should be specified.

A maximum of five destinations can be configured for an interface. The DHCPv6 relay for the interface will be automatically disabled when all the relay destinations configured for that interface is removed.

Displaying the DHCPv6 Relay Configuration

To view the DHCPv6 relay configuration, use the `show ipv6 dhcp relay` command. For example:

```
-> show ipv6 dhcp relay
DHCPv6 Relay: Enabled
```

Interface	Relay Destination(s)	Status
vlan-41	ff02::1:2	Enabled
vlan-103	2001:dbc8:8003::17	Disabled
	2001:dbc8:8004::99	
vlan-200	fe80::cd0:deff:fe28:1ca5 vlan-201	Enabled
tunnel-2	2001:dbc8:a23::ea77	Enabled

Verifying the IPv6 Configuration

A summary of the **show** commands used for verifying the IPv6 configuration is given here:

show ipv6 information	Displays IPv6 information.
show ipv6 interface	Displays the status and configuration of IPv6 interfaces.
show ipv6 tunnel configured	Displays IPv6 configured tunnel information.
show ipv6 tunnel 6to4	Displays IPv6 6to4 tunnel information.
show ipv6 routes	Displays the IPv6 Forwarding Table.
show ipv6 route-pref	Displays the configured route preference of a router.
show ipv6 router database	Displays a list of all routes (static and dynamic) that exist in the IPv6 router database.
show ipv6 prefixes	Displays IPv6 subnet prefixes used in router advertisements.
show ipv6 neighbors	Displays the IPv6 Neighbor Table.
show ipv6 ra-filter	Displays the RA filter configuration for an IPv6 interface.
show ipv6 tcp listeners	Displays statistics for IPv6 listener traffic.
show ipv6 tcp connections	Displays statistics for IPv6 connection traffic.
show ipv6 icmp statistics	Displays ICMP6 statistics.
show ipv6 ra-filter	Displays the IPv6 Path MTU Table.
show ipv6 tcp connections	Displays TCP Over IPv6 Connection Table. Contains information about existing TCP connections between IPv6 endpoints.
show ipv6 tunnel 6to4	Displays the UDP Over IPv6 Listener Table. Contains information about UDP/IPv6 endpoints.
show ipv6 rip	Displays the RIPng status and general configuration parameters.
show ipv6 redistrib	Displays the route map redistribution configuration.
show ipv6 dhcp relay	Displays all the interface on which the DHCPv6 relay is configured, the relay destinations, and the status of the DHCPv6 relay.

For more information about the displays that result from these commands, see the *OmniSwitch AOS Release 8 CLI Reference Guide*.

19 Configuring IPsec

Internet Protocol security (IPsec) is a suite of protocols for securing IPv6 communications by authenticating and/or encrypting each IPv6 packet in a data stream. IPsec is a framework of open standards designed to provide inter-operable, high quality, cryptographically-based security for IPv6 networks through the use of appropriate security protocols, cryptographic algorithms, and cryptographic keys. The set of security services offered includes access control, connectionless integrity, data origin authentication, detection and rejection of replays (a form of partial sequence integrity), and confidentiality (through encryption).

These security services are provided through use of two security protocols, the Authentication Header (AH) and the Encapsulating Security Payload (ESP), and through the use of cryptographic key management procedures and protocols.

Note. The OmniSwitch currently supports IPsec for IPv6 only.

In This Chapter

This chapter describes the basic components of IPsec and how to configure them through the Command Line Interface (CLI). CLI commands are used in the configuration examples; for more details about the syntax of commands, see the *OmniSwitch CLI Reference Guide*.

Configuration procedures described in this chapter include:

- Master Key Configuration (see [“Configuring an IPsec Master Key”](#) on page 19-10).
- Security Policy Configuration (see [“Configuring an IPsec Policy”](#) on page 19-11).
- Security Policy Rule Configuration (see [“Configuring an IPsec Rule”](#) on page 19-14).
- SA Configuration (see [“Configuring an IPsec SA”](#) on page 19-15).
- Security Association Key Configuration (see [“Configuring IPsec SA Keys”](#) on page 19-16).
- Discard Policy Configuration (see [“Assigning an Action to a Policy”](#) on page 19-13)

IPsec Specifications

Platforms Supported	OmniSwitch 6860, 6860E
IP Version Supported	IPv6
RFCs Supported	4301 - Security Architecture for the Internet Protocol 4302 - IP Authentication Header (AH) 4303 - IP Encapsulating Security Payload (ESP) 4305 - Cryptographic Algorithm Implementation Requirements for ESP and AH 4308 - Cryptographic Suites for IPsec
Encryption Algorithms Supported for ESP	NULL, 3DES-CBC, and AES-CBC
Key lengths supported for Encryption Algorithms	3DES-CBC - 192 bits AES-CBC - 128, 192, or 256 bits
Authentication Algorithms Supported for AH	HMAC-SHA1-96, HMAC-MD5-96, and AES-XCBC-MAC-96
Key lengths supported for Authentication Algorithms	HMAC-MD5 - 128 bits HMAC-SHA1 - 160 bits AES-XCBC-MAC - 128 bits
Master Security Key formats	Hexadecimal (16 bytes) or String (16 characters)
Priority value range for IPsec Policy	1 - 1000 (1=highest priority, 1000=lowest priority)
Index value range for IPsec Policy Rule	1 - 10
SPI Range	256 - 999999999
Modes Supported	Transport
License Requirements	Advanced License

IPsec Defaults

The following table shows the default settings of the configurable IPsec parameters.

Parameter Description	Command	Default Value/Comments
IPsec global status (A license file must be present on the switch)		Disabled
Master security key for the switch	ipsec security-key	No master security key set
IPsec policy priority	ipsec policy	100
IPsec security policy status	ipsec policy	Disabled
IPsec discard policy status	ipsec policy	Enabled
IPsec SA status	ipsec sa	Disabled
Key length AES-CBC	ipsec sa	128 bits

Quick Steps for Configuring an IPsec AH Policy

IP Authentication Header (AH) provides data origin authentication, data integrity, and replay protection. Data integrity verifies that the contents of the datagram were not changed in transit, either deliberately or due to random errors, however, AH does not provide data encryption.

1 Configure the master security key. The master security key must be set if keys are to be encrypted when saved in the vcboot.cfg and snapshot files.

```
-> ipsec security-key master-key-12345
```

2 Define the policy. A policy defines the traffic that requires IPsec protection. The commands below define a bi-directional policy for any protocol and the associated IPv6 address ranges. For example:

```
-> ipsec policy ALLoutMD5 source 664:1:1:1::199/64 destination 664:1:1:1::1/64
protocol any out ipsec admin-state disable
```

```
-> ipsec policy ALLinMD5 source 664:1:1:1::1/64 destination 664:1:1:1::199/64
protocol any in ipsec admin-state disable
```

3 Define the rule. A rule defines the security services for the traffic defined by its associated policy. For example the commands below add an AH rule to the policies defined above:

```
-> ipsec policy ALLoutMD5 rule 1 ah
-> ipsec policy ALLinMD5 rule 1 ah
```

4 Enable the policies. A policy cannot be enabled until the rules are defined. Now that rules have been defined, enable the policy using the commands below:

```
-> ipsec policy ALLoutMD5 admin-state enable
-> ipsec policy ALLinMD5 admin-state enable
```

5 Define the Security Keys. Each SA has its own unique set of security keys. The key name is the SA name that is going to use the key and the length must match the authentication algorithm key size. Keys must be defined before the SA can be enabled.

```
-> ipsec key ALLoutMD5_SA sa-authentication 0x11112222333344445555666677778888
-> ipsec key ALLinMD5_SA sa-authentication 0x11112222333344445555666677778888
```

6 Define the SA. An SA specifies the actual actions to be performed. The security parameters index (SPI) helps identify the source/destination pair. The security parameters index (SPI) in combination with the source and destination addresses uniquely identifies an SA. An identical SA (same SPI, source, and destination) must be configured on both systems exchanging IPsec protected traffic.

```
-> ipsec sa ALLoutMD5_SA ah source 664:1:1:1::199 destination 664:1:1:1::1 spi
2000 authentication HMAC-MD5 admin-state enable
```

```
-> ipsec sa ALLinMD5_SA ah source 664:1:1:1::1 destination 664:1:1:1::199 spi
2001 authentication HMAC-MD5 admin-state enable
```

7 Use the following **show** commands to verify the IPsec configuration:

```
-> show ipsec policy
-> show ipsec sa
-> show ipsec key sa-authentication
```

Quick Steps for Configuring an IPsec Discard Policy

IPsec can be used for discarding IPv6 traffic as well as configuring encryption and authentication. For discard policies, no rules, SAs or keys need to be defined.

1 Define the policy. The commands below use similar policy information as in the previous example but the action has been changed to discard:

```
-> ipsec policy Discard_ALLoutMD5 source 664:1:1:1::199/64 destination  
664:1:1:1::1/64 protocol any out discard admin-state enable
```

```
-> ipsec policy Discard_ALLinMD5 source 664:1:1:1::1/64 destination  
664:1:1:1::199/64 protocol any in discard admin-state enable
```

2 Use the following show commands to verify the IPsec configuration:

```
-> show ipsec policy  
-> show ipsec ipv6 statistics
```

IPsec Overview

IPsec provides protection to IPv6 traffic. To achieve this, IPsec provides security services for IPv6 packets at the network layer. These services include access control, data integrity, authentication, protection against replay, and data confidentiality. IPsec enables a system to select the security protocols, encryption and authentication algorithms, and use any cryptographic keys as required. IPsec uses the following two protocols to provide security for an IPv6 datagram:

- Encapsulating Security Payload (ESP) to provide confidentiality, data origin authentication and connectionless integrity.
- Authentication Header (AH) to provide connectionless integrity and data origin authentication for IPv6 datagrams and to provide optional protection against replay attacks. Unlike ESP, AH does not provide confidentiality.

IPsec on an OmniSwitch operates in Transport mode. In transport mode only the payload of the IPv6 packet is encapsulated, and an IPsec header (AH or ESP) is inserted between the original IPv6 header and the upper-layer protocol header. The figure below shows an IPv6 packet protected by IPsec in transport mode.

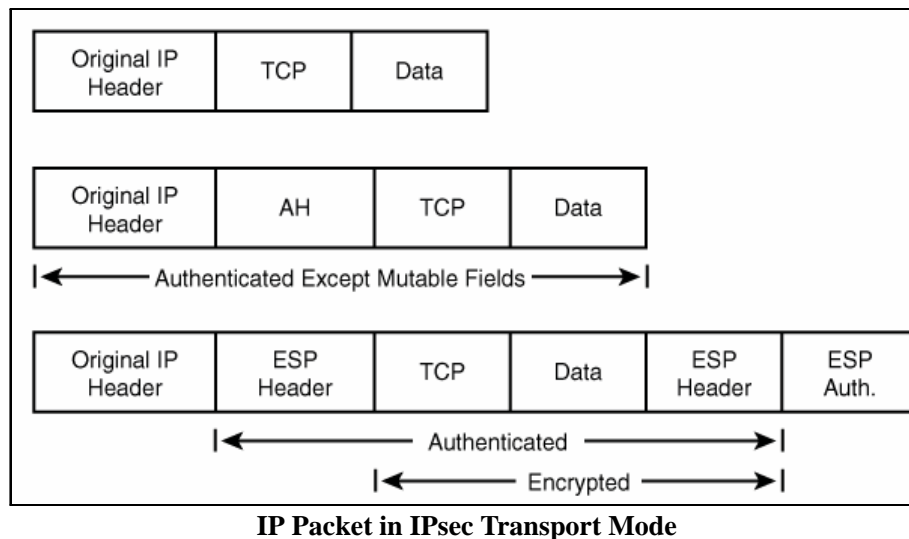

Note. The OmniSwitch currently supports the Transport Mode of operation.

Encapsulating Security Payload (ESP)

The ESP protocol provides a means to ensure privacy (encryption), source authentication, and content integrity (authentication). It helps provide enhanced security of the data packet and protects it against eavesdropping during transit.

Unlike AH which only authenticates the data, ESP encrypts data and also optionally authenticates it. It provides these services by encrypting the original payload and encapsulating the packet between a header and a trailer, as shown in the figure below.

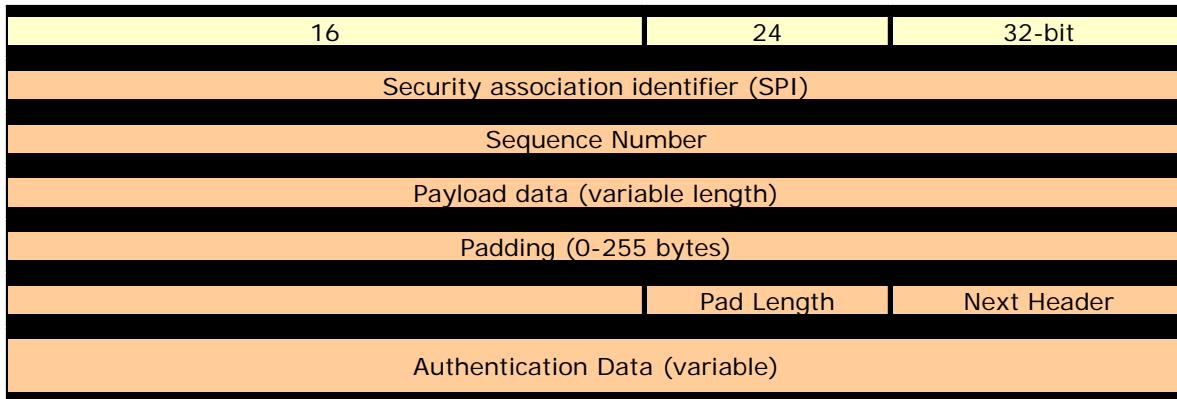

IP Packet protected by ESP

ESP is identified by a value of 50 in the IPv6 header. The ESP header is inserted after the IPv6 header and before the upper layer protocol header. The Security Parameter Index (SPI) in the ESP header is a 32-bit value that, combined with the destination address and protocol in the preceding IPv6 header, identifies the security association (SA) to be used to process the packet. SPI helps distinguish multiple SA's configured for the same source and destination combination. The payload data field carries the data that is being encrypted by ESP. The Authentication digest in the ESP header is used to verify data integrity.

Authentication is always applied after encryption, so a check for validity of the data is done upon receipt of the packet and before decryption.

Encryption Algorithms

There are several different encryption algorithms that can be used in IPsec. However, the most commonly used algorithms are "AES" and "3DES". These algorithms are used for encrypting IPv6 packets.

- Advanced Encryption Standard - Cipher Block Chaining - (AES-CBC)

The AES-CBC mode comprises three different key lengths; AES-128, AES-192 and AES-256. Each block of plaintext is XOR'd with the previous encrypted block before being encrypted again.

- Triple DES (3DES)

A mode of the DES encryption algorithm that encrypts data three times. Three 64-bit keys are used, instead of one, for an overall key length of 192 bits (the first encryption is encrypted with second key, and the resulting cipher text is again encrypted with a third key). 3DES is a more powerful version of DES.

Authentication Header (AH)

An Authentication Header (AH) provides connectionless integrity and data origin authentication. This protocol permits communicating parties to verify that data was not modified in transit and that it was genuinely transmitted from the apparent source. AH helps verify the authenticity/integrity of the content and origin of a packet. It can optionally protect against replay attacks by using the sliding window technique and discarding old packets. It authenticates the packet by calculating the checksum through hash-based message authentication code (HMAC) using a secret key and either HMAC-MD-5 or HMAC-SHA1 hash functions.

Authentication Algorithms

- HMAC-MD5 - An algorithm that produces a 128-bit hash (also called a digital signature or message digest) from a message of arbitrary length and a 16-byte key. The resulting hash is used, like a fingerprint of the input, to verify content and source authenticity and integrity.
- HMAC-SHA1 - An algorithm that produces a 160-bit hash from a message of arbitrary length and a 20-byte key. It is generally regarded as more secure than MD5 because of the larger hashes it produces.
- AES-XCBC-MAC-96 - An algorithm that uses AES [AES] in CBC mode [MODES] with a set of extensions [XCBC-MAC-1] to overcome the limitations of the classic CBC-MAC algorithm. It uses the AES block cipher with an increased block size and key length (128 bits) which enables it to withstand continuing advances in crypto-analytic techniques and computational capability. Its goal is to ensure that the datagram is authentic and cannot be modified in transit.

Unlike ESP, AH does not encrypt the data. Therefore, it has a much simpler header than ESP. The figure below shows an AH-protected IPv6 packet.

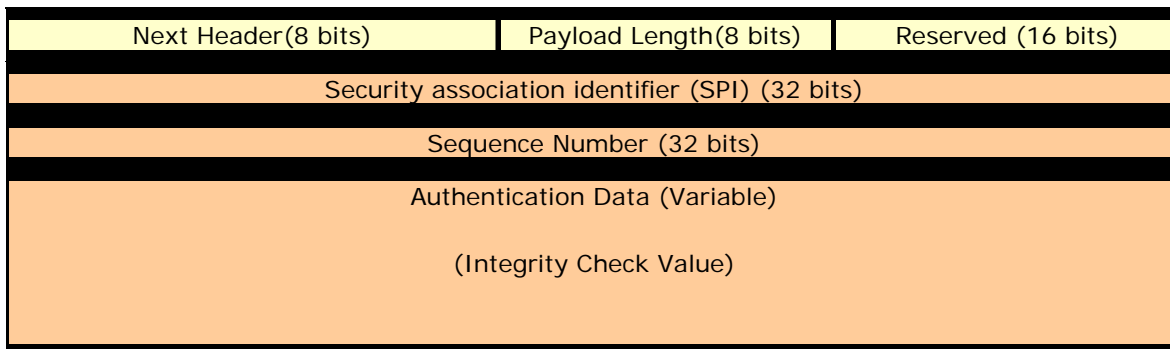

IP Packet protected by AH

AH is identified by a value of 51 in the IPv6 header. The Next header field indicates the value of the upper layer protocol being protected (for example, UDP or TCP) in the transport mode. The payload length field in the AH header indicates the length of the header. The SPI, in combination with the source and destination addresses, helps distinguish multiple SAs configured for the same source and destination combination. The AH header provides a means to verify data integrity. It is similar to the integrity check provided by the ESP header with one key difference. The ESP integrity check only verifies the contents of the ESP payload. AH's integrity check also includes portions of the packet header as well.

IPsec on the OmniSwitch

IPsec allows the following 3 types of actions to be performed on an IPv6 datagram that matches the filters defined in the security policy:

- The IPv6 datagram can be subjected to IPsec processing, encrypted, and/or authenticated through ESP and AH protocols.
- The IPv6 datagram can be discarded.
- The IPv6 datagram can be permitted to pass without being subjected to any IPsec processing.

The system decides which packets are processed and how they are processed by using the combination of the policy and the SA. The policy is used to specify which IPsec protocols are used such as AH or ESP while the SA specifies the algorithms such as AES and HMAC-MD5.

Securing Traffic Using IPsec

Securing traffic using IPsec requires the following main procedures below:

- Master Security Key - Used to encrypt SA keys when stored on the switch.
- Policies - Determines which traffic must be processed using IPsec.
- Policy Rules - Determines whether AH, ESP, or a combination of both must be used.
- Security Associations (SAs) - Determines which algorithms must be used to secure the traffic.
- SA Keys - Determines the keys to be used with the SA to secure the traffic.

Master Security Key

The master security key is used to encrypt and decrypt the configured SA keys that are saved to permanent storage (for example, **vcboot.cfg** file). If no master security key is configured, SA keys are stored unencrypted. Therefore, configuring a master key is **VITALLY IMPORTANT** and **STRONGLY RECOMMENDED**. A warning message will be logged if the config is saved without a Master Security Key being set.

IPsec Policy

IPsec Policies define which traffic requires IPsec processing. The policy requires the source and destination of the traffic to be specified as IPv6 addresses. The policy may cover all traffic from source to destination or may further restrict it by specifying an upper-layer protocol, source, and/or destination ports. Each policy is unidirectional, applying either to inbound or outbound traffic. Therefore, to cover all traffic between a source and destination, two policies would need to be defined.

IPsec Policy Rules

Rules are created and applied to policies. Rules determine what type of encryption or authentication must be used for the associated policy. For example, for a security policy where an IPv6 payload must be protected by an ESP header, which must then be protected by an AH header, two rules would be applied to the policy, one for ESP and one for AH.

Security Association (SA)

A Security Association, more commonly referred to as an SA, is a basic building block of IPsec. It specifies the actual IPsec algorithms to be employed. SA is a unidirectional agreement between the participants regarding the methods and parameters to use in securing a communication channel. A Security Association is a management tool used to enforce a security policy in the IPsec environment. SA actually specifies encryption and authentication between communicating peers.

Manually configured SAs are unidirectional; bi-directional communication requires at least two SAs, one for each direction. Manually-configured SAs are specified by a combination of their SPI, source and destination addresses. However, multiple SAs can be configured for the same source and destination combination. Such SAs are distinguished by a unique Security Parameter Index (SPI).

SA Keys

Keys are used for encrypting and authenticating the traffic. Key lengths must match what is required by the encryption or authentication algorithm specified in the SA. Key values may be specified either in hexadecimal format or as a string.

Note. The OmniSwitch currently supports manually configured SAs only.

Discarding Traffic using IPsec

In order to discard IPv6 datagrams, a policy is configured in the same manner as an IPsec security policy, the difference being that the action is set to 'discard' instead of 'ipsec'. A discard policy can prevent IPv6 traffic from traversing the network.

Configuring IPsec on the OmniSwitch

Before configuring IPsec the following security best practices must be followed:

- Set the Master Security Key - This is used to encrypt SA keys when stored.
- Use SSH, HTTPS, or SNMPv3 to prevent sensitive information such as SA keys from being sent in the clear.
- Restrict IPsec commands to authorized users only. This is described in Chapter 6, “Managing Switch User Accounts.” in the *OmniSwitch AOS Release 8 Switch Management Guide*.

Configuring IPsec for securing IPv6 traffic on a switch requires several steps which are explained below

- Configure the master security key for the switch which is used to encrypt and decrypt the configured SA keys. This is described in [“Configuring an IPsec Master Key” on page 19-10](#).
- Configure an IPsec Security Policy on the switch. This is described in [“Configuring an IPsec Policy” on page 19-11](#).
- Set an IPsec rule for the configured IPsec Security Policy on the switch. This is described in [“Configuring an IPsec Rule” on page 19-14](#).
- Enable the Security Policy. This is described in [“Enabling and Disabling a Policy” on page 19-12](#).
- Configure the authentication and encryption keys required for manually configured IPsec Security associations (SA). This is described in [“Configuring IPsec SA Keys” on page 19-16](#)
- Configure an IPsec Security Association on the switch by setting parameters such as Security Association type, encryption and authentication for SA. This is described in [“Configuring an IPsec SA” on page 19-15](#).

Configuring IPsec for discarding IPv6 traffic on a switch requires a single step:

- Configure the IPsec Discard policy on the switch which is used to discard or filter the IPv6 packets. This is described in [“Discarding Traffic using IPsec” on page 19-9](#).

Configuring an IPsec Master Key

The master security key is used to encrypt and decrypt the configured SA keys that are saved to permanent storage (for example, `vcboot.cfg` file). To set a master security key the first time, simply enter the `ipsec security-key` command along with a new key value. For example:

```
-> ipsec security-key new_master_key_1  
  
or  
  
-> ipsec security-key 0x12345678123456781234567812345678
```

Note. The key value can be specified either in hexadecimal format (16 bytes in length) or as a string (16 characters in length). A warning message is logged if SA keys are set without the Master Key being set.

To change the master security key specify the old and new key values.

```
-> ipsec security-key new_master_key_1 new_master_key_2
```

The above command replaces the old security key with the new key value. The old key value must be entered to modify an existing key. If an incorrect old key value is entered, then setting the new key will fail.

When the master security key is set or changed, its value is immediately propagated to the secondary CMM. When the master security key is changed, save and synchronize the current configuration to ensure the proper operation of IPsec in the event of a switch reboot or takeover.

Note. By default, no master security key is set for the switch. When no master security key is configured for the switch, the SA key values are written unencrypted to permanent storage (**vcboot.cfg** or other configuration file).

Configuring an IPsec Policy

A policy determines how traffic is going to be processed. For example, policies are used to decide if a particular IPv6 packet needs to be processed by IPsec or not. If security is required, the security policy provides general guidelines as to how it must be provided, and if necessary, links to more specific detail.

Each IPsec security policy is unidirectional and can be applied to IPv6 inbound or outbound traffic depending upon the security level required for the network. Therefore, in order to cover all traffic between source and destination, a minimum of two policies need to be defined; one policy for inbound traffic and another policy for outbound traffic.

To configure an IPsec policy, use the **ipsec policy** command along with the policy name, source IPv6 address, destination IPv6 address and optional parameters such as IPv6 port number, and protocol to which the security policy gets applied. For example:

Local System

```
-> ipsec policy tcp_in source 3ffe:1:1:1::99 destination 3ffe:1:1:1::1 protocol
tcp in ipsec description "IPsec on all inbound TCP" admin-state enable

-> ipsec policy tcp_out source 3ffe:1:1:1::1 destination 3ffe:1:1:1:99 protocol
tcp out ipsec description "IPsec on all outbound TCP" admin-state enable
```

Remote System

```
-> ipsec policy tcp_out source 3ffe:1:1:1::99 destination 3ffe:1:1:1::1 proto-
col tcp out ipsec description "IPsec on all outbound TCP" admin-state enable

-> ipsec policy tcp_in source 3ffe:1:1:1::1 destination 3ffe:1:1:1:99 protocol
tcp in ipsec description "IPsec on all inbound TCP" admin-state enable
```

The above commands configure a bi-directional IPsec policy for IPv6 traffic destined to or from the specified IPv6 addresses and indicates the traffic must be processed using IPsec.

Prefixes can also be used when configuring a policy to match a range of addresses as shown below:

```
-> ipsec policy tcp_in source 3ffe::/16 destination 4ffe::/16 protocol tcp in ipsec
description "Any 3ffe to any 4ffe" admin-state enable
```

Use the no form of the command to remove the configured IPsec policy. For example:

```
-> no ipsec policy tcp_in
```

Enabling and Disabling a Policy

You can administratively enable or disable the configured security policy by using the keywords **admin-state enable/disable** after the command as shown below:

```
-> ipsec policy tcp_in admin-state disable
```

The above command disables the configured IPsec security policy.

Note. Policies cannot be enabled until at least one rule is configured. See [“Configuring an IPsec Rule” on page 19-14.](#)

Assigning a Priority to a Policy

You can use the optional **priority** parameter to assign a priority to the configured IPsec policy so that if IPv6 traffic matches more than one configured policy, the policy with the highest priority is applied to the traffic. The policy with the lower value has the higher priority. For example:

```
-> ipsec policy tcp_in priority 500
```

Note. If two security policies have the same priority then the one configured first will be processed first.

Policy Priority Example

```
-> ipsec policy telnet_deny priority 1000 source ::/0 destination ::/0 port 23
protocol tcp in discard
```

```
-> ipsec policy telnet_ipsec priority 200 source 3ffe:1200::/32 destination ::/0
port 23 protocol tcp in ipsec admin-state disable
```

```
-> ipsec policy telnet_ipsec rule 1 esp
```

```
-> ipsec policy telnet_ipsec admin-state enable
```

```
-> ipsec policy telnet_clear priority 100 source 3ffe:1200::1 destination ::/0
port 23 protocol tcp in none
```

```
-> ipsec policy telnet_malicious priority 1 source 3ffe:1200::35 destination ::/
0 port 23 protocol tcp in discard
```

- 1** Policy **telnet_deny** is the lowest priority policy. It will discard any incoming telnet connection attempts.
- 2** Policy **telnet_ipsec** covers a subset of the source addresses of **telnet_deny**. With its greater priority, it overrides **telnet_deny** and allows incoming telnet connections from addresses starting with the prefix **3ffe:1200::/32** as long as they are protected by ESP.
- 3** The policy **telnet_clear** overrides **telnet_ipsec**, allowing telnet connection attempts from the host to be accepted without any IPsec protection.
- 4** Policy **telnet_malicious** can be configured to handle a known malicious system that otherwise would fall under the **telnet_ipsec** policy. Its priority of 1 ensures that it always takes precedence and discards any incoming telnet connection attempts from the known malicious system.

Assigning an Action to a Policy

To define what action will be performed on the traffic specified in the security policy, you can use the following parameters:

- **discard** - Discards the IPv6 packets.
- **ipsec** - Allows IPsec processing of the traffic to which this policy is applied.

If the action is ipsec, then a rule must be defined before the policy can be enabled. Additionally, SAs and SA keys must also be configured to support the rule.

- **none** - No action is performed.

The above commands could be modified to discard the traffic instead of processing using IPsec.

```
-> ipsec policy tcp_in discard
-> ipsec policy tcp_out discard
```

Configuring the Protocol for a Policy

You can define the type of protocol to which the security policy can be applied by using the **protocol** parameter. For example:

```
-> ipsec policy udp_in source ::/0 destination 3ffe:200:200:4001::99 protocol
udp in ipsec description "IPsec on all inbound UDP" admin-state enable
```

The following table lists the various protocols that can be specified, refer to the [ipsec policy](#) command for additional details.

protocol			
any	icmp6 [<i>type type</i>]	tcp	udp
ospf	vrrp	number protocol	

Verifying a Policy

To verify the configured IPsec policy, use the [show ipsec policy](#) command. For example:

```
-> show ipsec policy
Name          Priority Source-> Destination          Protocol Direction Action State
-----+-----+-----+-----+-----+-----+-----+-----
tcp_in        500      3ffe:1:1:1::99->3ffe:1:1:1::1    TCP      in      ipsec esp active
tcp_out       500      3ffe:1:1:1::1->3ffe:1:1:1::99    TCP      out     ipsec esp active
ftp-in-drop   100      ::/0->::/0                        TCP      in      discard disabled
telnet-in-1   100      2000::/48->::/0                    TCP      in      ipsec disabled
```

The above command provides examples of various configured policies.

Note. The presence of a '+' sign in the 'Source->Destination' or 'Action' indicates the values has been truncated to fit. View a specific security policy to view additional details.

You can also verify the configuration of a specific security policy by using the [show ipsec policy](#) command followed by the name of the security policy. For example:

```
-> show ipsec policy tcp_in
Name          = tcp_in
Priority      = 500
Source        = 3ffe:1:1:1::99
Destination   = 3ffe:1:1:1::1
Protocol      = TCP
Direction     = in
Action        = ipsec
State         = active
Rules:
  1 : esp
Description:
  IPsec on all inbound TCP
```

Configuring an IPsec Rule

To configure an IPsec rule for a configured IPsec security policy, use the **ipsec policy rule** command along with the policy name, index value for the IPsec policy rule, and IPsec protocol type (AH or ESP). For example:

```
-> ipsec policy tcp_in rule 1 esp
```

The above command applies the configured IPsec security policy with rule 1 to ESP. The index value specified determines the order in which a rule must get applied to the payload. The policy name configured for the IPsec policy rule must be the same as the policy name configured for the IPsec security policy. It's possible to first encrypt the original content of an IPv6 packet using ESP and then authenticate the packet using AH by configuring an ESP rule with an index of one and then configuring the AH rule with an index of two. For example:

```
-> ipsec policy tcp_in rule 1 esp
-> ipsec policy tcp_in rule 2 ah
```

Use the **no** form of this command to remove the configured IPsec rule for an IPsec security policy. For example:

```
-> no ipsec policy tcp_in rule 2
```

Verifying IPsec rule for IPsec Policy

To verify the IPsec policy, use the **show ipsec policy** command. For example:

```
-> show ipsec policy tcp_in
Name          = tcp_in
Priority      = 500
Source        = 3ffe:1:1:1::99
Destination   = 3ffe:1:1:1::1
Protocol      = TCP
Direction     = in
Action        = ipsec
State         = active
Rules:
  1 : esp,
  2 : ah
Description:
  IPsec on all inbound TCP
```

Configuring an IPsec SA

IPsec Security Association (SA) is a set of security information that describes a particular kind of secure connection between two devices. An SA specifies the actual IPsec algorithms applied to the IPv6 traffic (for example encryption using 3DES, HMAC-SHA1 for authentication).

To configure an IPsec Security Association, use the **ipsec sa** command along with the type of security association, IPv6 source address, IPv6 destination address, encryption and authentication algorithms used for SA. For example:

Local System

```
-> ipsec sa tcp_in_ah ah source 3ffe:1:1:1::99 destination 3ffe:1:1:1::1 spi
9901 authentication hmac-sha1 description "HMAC SHA1 on traffic from 99 to 1"

-> ipsec sa tcp_out_ah ah source 3ffe:1:1:1::1 destination 3ffe:1:1:1::99 spi
9902 authentication hmac-sha1 description "HMAC SHA1 on traffic from 1 to 99"
```

Remote System

```
-> ipsec sa tcp_out_ah ah source 3ffe:1:1:1::99 destination 3ffe:1:1:1::1 spi
9901 authentication hmac-sha1 description "HMAC SHA1 on traffic from 99 to 1"

-> ipsec sa tcp_in_ah ah source 3ffe:1:1:1::1 destination 3ffe:1:1:1::99 spi
9902 authentication hmac-sha1 description "HMAC SHA1 on traffic from 1 to 99"
```

The above commands configure bi-directional IPsec SAs of AH type for data traffic to and from source IPv6 addresses 3ffe:1:1:1::99 and 3ffe:1:1:1::1 with security parameter indexes (SPI) of 9901 and 9902. The combination of SPI, source, and destination addresses uniquely identify an SA. The above commands also configure hmac-sha1 as the type of authentication algorithm which is to be used for the IPv6 traffic covered by the configured SA.

Note. The IPsec endpoints must have identical SAs (SPI, source address, destination addresses) configured

Use the **admin-state enable/disable** parameters to enable or disable the SA.

```
-> ipsec sa tcp_in_ah admin-state enable
```

Use the **no** form of the command to disable the SA.

```
-> no ipsec sa tcp_in_ah
```

Configuring ESP or AH

The IPsec SA can be configured as ESP or AH. In the above example, the IPsec SA is configured as AH. You can also configure the SA as ESP, as shown below:

```
-> ipsec sa tcp_in_ah esp source 3ffe:1:1:1::99 destination 3ffe:1:1:1::1 spi
9901 encryption 3DES-CBC description "3DES on traffic from 99 to 1"
```

You can use the **encryption** parameter to specify the encryption algorithm to be used for the traffic covered by the SA. This parameter can only be used when the SA type is ESP.

Configuring the ESP Key Size

Some types of encryption algorithms allow the key size to be specified; specifying the key lengths overrides their default values. To do so, use the **key-size** option after the specified encryption algorithm. For example:

```
-> ipsec sa tcp_in_ah esp source 3ffe:1:1:1::99 destination 3ffe:1:1:1::1 spi
9901 encryption aes-cbc key-size 192
```

The above command configures an IPsec SA of ESP using aes-cbc and a key length of 192 bits. You can allow an IPsec SA to operate as an ESP confidentiality-only SA by using the **none** option with the authentication parameter or by simply omitting the authentication parameter from the command.

Refer to “[Configuring IPsec SA Keys](#)” on page 19-16 or the **ipsec sa** command for supported encryption types and key lengths.

Verifying IPsec SA

To display the configured IPsec SA, use the **show ipsec sa** command. For example:

```
-> show ipsec sa
Name          Type  Source-> Destination[SPI]          Encryption Authentication State
-----+-----+-----+-----+-----+-----+-----+-----+-----+-----+-----+-----+-----+-----+-----+-----+
tcp_in_ah    ah    3ffe:1:1:1::99 -> 3ffe:1:1:1::1 [9901]    none          hmac-shal     active
tcp_out_ah   ah    3ffe:1:1:1::1 -> 3ffe:1:1:1::99 [9902]    none          hmac-shal     active
```

To display the configuration of a specific IPsec SA, use the **show ipsec sa** command followed by the name of the configured IPsec SA. For example:

```
-> show ipsec sa tcp_in_ah

Name          = tcp_in_ah
Type          = AH
Source        = 3ffe:1:1:1::99,
Destination   = 3ffe:1:1:1::1,
SPI           = 9901
Encryption    = none
Authentication = hmac-shal
State         = active
Description:
  "HMAC SHA1 on traffic from 99 to 1
```

Configuring IPsec SA Keys

To configure the authentication and encryption keys for a manually configured SA, use the **ipsec key** command along with the SA name and key value which will be used for AH or ESP. For example:

```
-> ipsec key tcp_in_ah sa-authentication 0x11223344556677889900112233445566
```

The above command configures an IPsec SA key named `tcp_in_ah`. This IPsec SA key will be used for the AH authentication protocol and has a value of `0x11223344556677889900112233445566`.

The length of the key value must match the value that is required by the encryption or authentication algorithm that will use the key. The table shown below displays the key lengths for the supported algorithms:

Algorithm	Key Length
3DES-CBC	192 Bits
AES-CBC	128, 192, or 256 Bits

Algorithm	Key Length
HMAC-MD5	128 Bits
HMAC-SHA1	160 Bits
AES-XCBC-MAC	128 Bits

Use the following information to determine how to create the proper key size:

- Number of Characters = Key Size (in bits) / 8; Ex. A 160-bit key would require 20 characters for the key.
- Number of Hexidecimal = Key Size (in bits) / 4; Ex. A 160-bit key would require 40 hexadecimal digits.

Note. The *name* parameter must be the same as the name of the manually configured IPsec SA. Also, the combination of the key name and type must be unique.

Use the **no** form of this command to delete the configured IPsec SA key. For example:

```
-> no ipsec key tcp_in_ah
```

Verifying IPsec SA Key

To display the encryption key values which are configured for manually configured IPsec SAs, use the **show ipsec key** command. For example:

```
-> show ipsec key sa-encryption
Encryption Keys
Name                               Length (bits)
-----+-----
sa_1                               192
sa_2                               160
sa_3                               64
```

The above command shows the number of manually configured SAs along with their encryption key lengths in bits respectively. To display the IPsec SA keys used for authentication, use the **show ipsec key** command, as shown below:

```
-> show ipsec key sa-authentication
Authentication Keys
Name                               Length (bits)
-----+-----
tcp_in_ah                          160
sa_1                                128
sa_5                                160
```

The above command shows the number of manually configured SAs along with their authentication key lengths in bits respectively.

Note. Due to security reasons, key values will not be displayed; only key names and key lengths will be displayed.

Once IPsec is configured for IPv6 on the switch, you can monitor the incoming and outgoing packets for the configured parameters by using the **show ipsec ipv6 statistics** command.

Inbound:

```
Successful                = 2787
Policy violation          = 0
No SA found               = 0
Unknown SPI               = 0
AH replay check failed    = 0
ESP replay check failed   = 0
AH authentication success = 93
AH authentication failure = 0
ESP authentication success = 25
ESP authentication failure = 0
Packet not valid          = 0
No memory available       = 0
Outbound:
Successful                = 5135
Policy violation          = 0
No SA found               = 19
Packet not valid          = 0
No memory available       = 0
```

Additional Examples

Configuring ESP

The example below shows the commands for configuring ESP between two OmniSwitches for all TCP traffic.

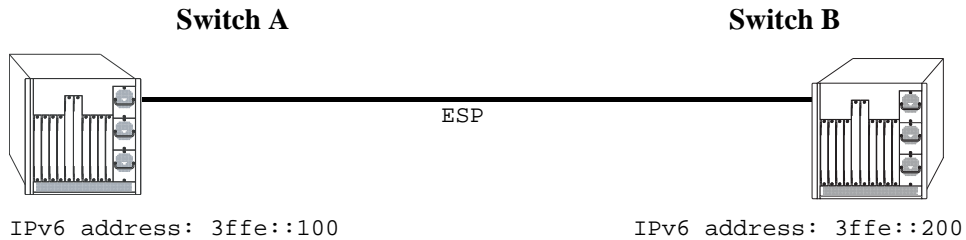

ESP Between Two OmniSwitches

Switch A

```
-> ipsec security-key master-key-12345

-> ipsec policy tcp_out source 3ffe::100 destination 3ffe::200 protocol tcp out
ipsec description "IPsec on TCP to 200"

-> ipsec policy tcp_in source 3ffe::200 destination 3ffe::100 protocol tcp in
ipsec description "IPsec on TCP from 200"

-> ipsec policy tcp_out rule 1 esp
-> ipsec policy tcp_in rule 1 esp
-> ipsec policy tcp_out admin-state enable
-> ipsec policy tcp_in admin-state enable

-> ipsec sa tcp_out_esp esp source 3ffe::100 destination 3ffe::200 spi 1000
encryption des-cbc authentication hmac-sha1 description "ESP to 200" admin-state
enable

-> ipsec sa tcp_in_esp esp source 3ffe::200 destination 3ffe::100 spi 1001
encryption des-cbc authentication hmac-sha1 description "ESP from 200" admin-
state enable

-> ipsec key tcp_out_esp sa-encryption 12345678
-> ipsec key tcp_out_esp sa-authentication 12345678901234567890
-> ipsec key tcp_in_esp sa-encryption 12345678
-> ipsec key tcp_in_esp sa-authentication 12345678901234567890
```

Switch B

```
-> ipsec security-key master-key-12345

-> ipsec policy tcp_out source 3ffe::200 destination 3ffe::100 protocol tcp out
ipsec description "IPsec on TCP to 100"

-> ipsec policy tcp_in source 3ffe::100 destination 3ffe::200 protocol tcp in
ipsec description "IPsec on TCP from 100"

-> ipsec policy tcp_out rule 1 esp
```

```
-> ipsec policy tcp_in rule 1 esp
-> ipsec policy tcp_out admin-state enable
-> ipsec policy tcp_in admin-state enable

-> ipsec sa tcp_out_esp esp source 3ffe::200 destination 3ffe::100 spi 1001
encryption des-cbc authentication hmac-sha1 description "ESP to 100" admin-state
enable

-> ipsec sa tcp_in_esp esp source 3ffe::100 destination 3ffe::200 spi 1000
encryption des-cbc authentication hmac-sha1 description "ESP from 100" admin-
state enable

-> ipsec key tcp_out_esp sa-encryption 12345678
-> ipsec key tcp_out_esp sa-authentication 12345678901234567890
-> ipsec key tcp_in_esp sa-encryption 12345678
-> ipsec key tcp_in_esp sa-authentication 12345678901234567890
```

Discarding RIPng Packets

RIPng uses the well known address of ff02::9 to advertise routes. The following example shows how IPsec can be configured to drop all RIPng packets.

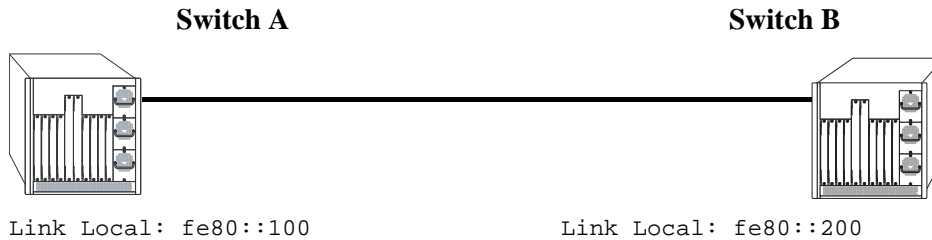

Discarding RIPng Packets

Switch A

```
-> ipsec policy DISCARD_UDPout source fe80::100 destination ff02::9 protocol udp  
out discard
```

```
-> ipsec policy DISCARD_UDPin source fe80::200 destination ff02::9 protocol udp  
in discard
```

Switch B

```
-> ipsec policy DISCARD_UDPout source fe80::200 destination ff02::9 protocol udp  
out discard
```

```
-> ipsec policy DISCARD_UDPin source fe80::100 destination ff02::9 protocol udp  
in discard
```

Verifying the IPsec Configuration

To display information such as details about manually configured IPsec Security Associations and other IPsec parameters configured on the switch, use the **show** commands listed in the following table::

show ipsec sa	Displays information about manually configured IPsec SAs.
show ipsec key	Displays encryption and authentication key values for the manually configured IPsec SA.
show ipsec policy	Displays information about IPsec Security Policies configured for the switch.
show ipsec ipv6 statistics	Displays IPsec statistics for IPv6 traffic.

For more information about the resulting displays from these commands, see the “IPsec Commands” chapter in the *OmniSwitch CLI Reference Guide*.

Examples of the above commands and their outputs are given in the section “[Configuring IPsec on the OmniSwitch](#)” on page 19-10

20 Configuring RIP

Routing Information Protocol (RIP) is a widely used Interior Gateway Protocol (IGP) that uses hop count as its routing metric. RIP-enabled routers update neighboring routers by transmitting a copy of their own routing table. The RIP routing table uses the most efficient route to a destination, that is, the route with the fewest hops and longest matching prefix.

The switch supports RIP version 1 (RIPv1), RIP version 2 (RIPv2), and RIPv2 that is compatible with RIPv1. It also supports text key and MD5 authentication, on an interface basis, for RIPv2.

In This Chapter

This chapter describes RIP and how to configure it through the Command Line Interface (CLI). It includes instructions for configuring basic RIP routing and fine-tuning RIP by using optional RIP configuration parameters (for example, RIP send/receive option and RIP interface metric). It also details RIP redistribution, which allows a RIP network to exchange routing information with networks running different protocols (for example, OSPF and BGP). CLI commands are used in the configuration examples; for more details about the syntax of commands, see the *OmniSwitch AOS Release 8 CLI Reference Guide*.

This chapter provides an overview of RIP and includes information about the following procedures:

- RIP Routing
 - Loading RIP (see [page 20-6](#))
 - Enabling RIP (see [page 20-7](#))
 - Creating a RIP Interface (see [page 20-7](#))
 - Enabling a RIP Interface (see [page 20-7](#))
- RIP Options
 - Configuring the RIP Forced Hold-Down Interval (see [page 20-9](#))
 - Configuring the RIP Update Interval (see [page 20-9](#))
 - Configuring the RIP Invalid Timer (see [page 20-10](#))
 - Configuring the RIP Garbage Timer (see [page 20-10](#))
 - Configuring the RIP Hold-Down Timer (see [page 20-10](#))
 - Enabling a RIP Host Route (see [page 20-11](#))
- RIP Redistribution
 - Configuring Route Redistribution (see [page 20-12](#))
- RIP Security
 - Configuring Authentication Type (see [page 20-18](#))
 - Configuring Passwords (see [page 20-18](#))

RIP Specifications

Platforms Supported	OmniSwitch 6860, 6860E
RFCs Supported	RFC 1058–RIP v1 RFC 2453–RIP v2 RFC 1722–RIP v2 Protocol Applicability Statement RFC 1724–RIP v2 MIB Extension
Maximum Number of Interfaces	10
Maximum Number of Peers	100
Maximum Number of Routes	10K
Maximum number of ECMP next hop entries	16

RIP Defaults

The following table lists the defaults for RIP configuration through the **ip rip** command.

Description	Command	Default
RIP Status	ip rip admin-state	disable
RIP Forced Hold-Down Interval	ip rip force-holddowntimer	0
RIP Update Interval	ip rip update-interval	30 seconds
RIP Invalid Timer	ip rip invalid-timer	180 seconds
RIP Garbage Timer	ip rip garbage-timer	120 seconds
RIP Hold-Down Timer	ip rip holddown-timer	0
RIP Interface Metric	ip rip interface metric	1
RIP Interface Send Version	ip rip interface send-version	v2
RIP Interface Receive Version	ip rip interface recv-version	both
RIP Host Route	ip rip host-route	enable
RIP Route Tag	ip rip host-route	0

Quick Steps for Configuring RIP Routing

To forward packets to a device on a different VLAN, you must create a router interface on each VLAN. To route packets by using RIP, you must enable RIP and create a RIP interface on the router interface. The following steps show you how to enable RIP routing between VLANs “from scratch”. If active VLANs and router ports have already been created on the switch, go to Step 7.

- 1 Create VLAN 1 with a description (for example, VLAN 1) by using the **vlan** command. For example:

```
-> vlan 1 name "VLAN 1"
```

- 2 Create VLAN 2 with a description (for example, VLAN 2) by using the **vlan** command. For example:

```
-> vlan 2 name "VLAN 2"
```

- 3 Assign an active port to VLAN 1 by using the **vlan members untagged** command. For example, the following command assigns port 1/1/1 to VLAN 1:

```
-> vlan 1 members port 1/1/1 untagged
```

- 4 Assign an active port to VLAN 2 by using the **vlan members** command. For example, the following command assigns port 1/1/2 VLAN 2:

```
-> vlan 2 members port 1/1/2 untagged
```

- 5 Configure an IP interface to enable IP routing on a VLAN by using the **ip interface** command. For example:

```
-> ip interface vlan-1 address 171.10.1.1 vlan 1
```

- 6 Configure an IP interface to enable IP routing on a VLAN by using the **ip interface** command. For example:

```
-> ip interface vlan-2 address 171.11.1.1 vlan 2
```

- 7 Load RIP into the switch memory by using the **ip load rip** command. For example:

```
-> ip load rip
```

- 8 Enable RIP on the switch by using the **ip rip admin-state** command. For example:

```
-> ip rip admin-state enable
```

- 9 Create a RIP interface on VLAN 1 by using the **ip rip interface** command. For example:

```
-> ip rip interface vlan-1
```

- 10 Enable the RIP interface by using the **ip rip interface admin-state** command. For example:

```
-> ip rip interface vlan-1 admin-state enable
```

- 11 Create an RIP interface on VLAN 2 by using the **ip rip interface** command. For example:

```
-> ip rip interface vlan-2
```

Note. For more information on VLANs and router ports, see [Chapter 4, “Configuring VLANs.”](#)

RIP Overview

In switching, traffic can be transmitted from one media type to another within the same VLAN. Switching happens at Layer 2, the link layer; routing happens at Layer 3, the network layer. In IP routing, traffic can be transmitted across VLANs. When IP routing is enabled, the switch uses routing protocols to build routing tables that keep track of stations in the network and decide the best path for forwarding data. When the switch receives a packet to be routed, it strips off the MAC header and examines the IP header. It looks up the source/destination address in the routing table, and then adds the appropriate MAC address to the packet. Calculating routing tables and stripping/adding MAC headers to packets is performed by switch software.

IP is associated with several Layer 3 routing protocols. RIP is built into the base code loaded onto the switch. Others are part of Alcatel-Lucent's optional Advanced Routing Software. IP supports the following IP routing protocols:

- **RIP**—An IGP that defines how routers exchange information. RIP makes routing decisions by using a “least-cost path” method. RIPv1 and RIPv2 services allow the switch to learn routing information from neighboring RIP routers. For more information and instructions for configuring RIP, see [“RIP Routing” on page 20-6](#).
- **Open Shortest Path First (OSPF)**—An IGP that provides a routing function similar to RIP but uses different techniques to determine the best route for a datagram. OSPF is part of Alcatel-Lucent's optional Advanced Routing Software. For more information see the “Configuring OSPF” chapter in the *OmniSwitch AOS Release 8 Advanced Routing Configuration Guide*.

When RIP is initially enabled on a switch, it issues a request for routing information, and listens for responses to the request. If a switch configured to supply RIP hears the request, it responds with a response packet based on information in its routing database. The response packet contains destination network addresses and the routing metric for each destination. When a RIP response packet is received, RIP takes the information and rebuilds the switch's routing database, adding new routes and “better” (lower metric) routes to destinations already listed in the database.

RIP uses a hop count metric to measure the distance to a destination. In the RIP metric, a switch advertises directly connected networks at a metric of 1. Networks that are reachable through one other gateway are 2 hops, networks that are reachable through two gateways are 3 hops, etc. Thus, the number of hops (or hop count) along a path from a given source to a given destination refers to the number of networks that are traversed by a datagram along that path. When a switch receives a routing update that contains a new or changed destination network entry, the switch adds one to the metric value indicated in the update and enters the network in the routing table. After updating its routing table, the switch immediately begins transmitting routing updates to inform other network switches of the change. These updates are sent independently of the regularly scheduled updates. By default, RIP packets are broadcast every 30 seconds, even if no change has occurred anywhere in a route or service.

RIP deletes routes from the database if the next switch to that destination says the route contains more than 15 hops. In addition, all routes through a gateway are deleted by RIP if no updates are received from that gateway for a specified time period. If a gateway is not heard from for 120 seconds, all routes from that gateway are placed in a hold-down state. If the hold-down timer value is exceeded, the routes are deleted from the routing database. These intervals also apply to deletion of specific routes.

RIP Version 2

RIP version 2 (RIPv2) adds additional capabilities to RIP. Not all RIPv2 enhancements are compatible with RIPv1. To avoid supplying information to RIPv1 routes that could be misinterpreted, RIPv2 can only use non-compatible features when its packets are multicast. Multicast is not supported by RIPv1. On interfaces that are not compatible with IP multicast, the RIPv1-compatible packets used do not contain potentially confusing information. RIPv2 enhancements are listed below.

- **Next Hop**—RIPv2 can advertise a next hop other than the switch supplying the routing update. This capability is useful when advertising a static route to a silent switch not using RIP, since packets passing through the silent switch do not have to cross the network twice.
- **Network Mask**—RIPv1 assumes that all subnetworks of a given network have the same network mask. It uses this assumption to calculate the network masks for all routes received. This assumption prevents subnets with different netmasks from being included in RIP packets. RIPv2 adds the ability to specify the network mask with each network in a packet. Because RIPv1 switches ignore the network mask in RIPv2 packets, their calculation of the network mask could possibly be wrong. For this reason, RIPv1-compatible RIPv2 packets cannot contain networks that would be misinterpreted by RIPv1. These networks must only be provided in native RIPv2 packets that are multicast.
- **Authentication**—RIPv2 packets can contain an authentication key that can be used to verify the validity of the supplied routing data. Authentication can be used in RIPv1-compatible RIPv2 packets, but RIPv1 switches ignore authentication information. Authentication is a simple password in which an authentication key of up to 16 characters is included in the packet. If this key does not match the configured authentication key, the packet is discarded. For more information on RIP authentication, see [“RIP Security” on page 20-18](#).
- **IP Multicast**—IP Multicast Switching (IPMS) is a one-to-many communication technique employed by emerging applications such as video distribution, news feeds, netcasting, and resource discovery. Unlike unicast, which sends one packet per destination, multicast sends one packet to all devices in any subnetwork that has at least one device requesting the multicast traffic. For more information on IPMS, see [Chapter 26, “Configuring IP Multicast Switching.”](#)

RIP Routing

IP routing requires IP router interfaces to be configured on VLANs and a routing protocol to be enabled and configured on the switch. RIP also requires a RIP interface to be created and enabled on the routing interface. In the illustration below, a router interface and RIP interface have been configured on each VLAN. Therefore, workstations connected to ports on VLAN 1 on Switch 1 can communicate with VLAN 2; workstations connected to ports on VLAN 3 on Switch 2 can communicate with VLAN 2. Also, ports from both switches have been assigned to VLAN 2, and a physical connection has been made between the switches. Therefore, workstations connected to VLAN 1 on Switch 1 can communicate with workstations connected to VLAN 3 on Switch 2.

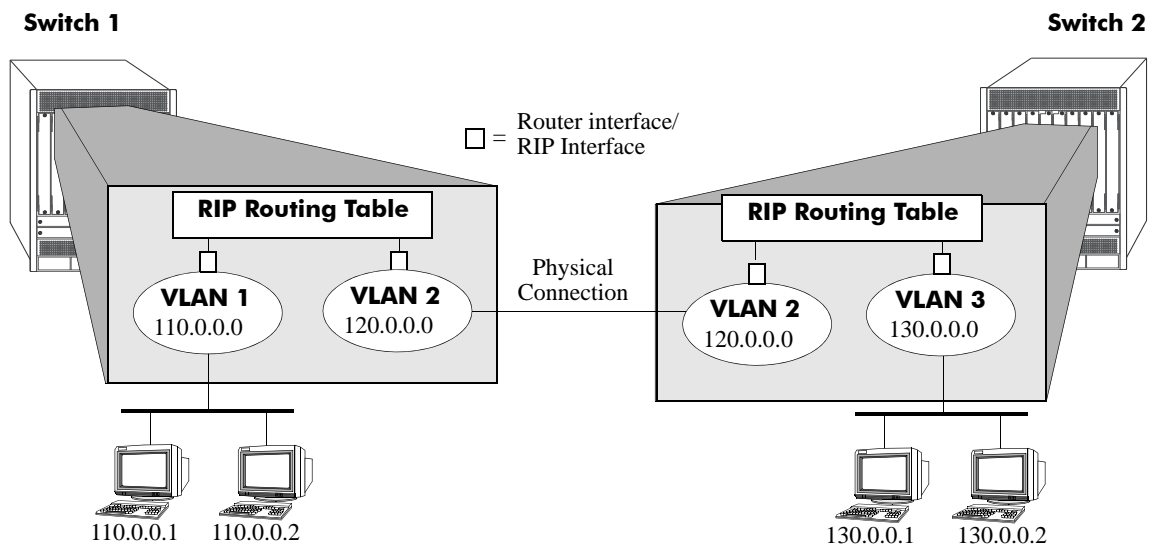

RIP Routing

Loading RIP

When the switch is initially configured, RIP must be loaded into the switch memory. Use the [ip load rip](#) command to load RIP.

To remove RIP from the switch memory, you must manually edit the `vcboot.cfg` file. The `vcboot.cfg` file is an ASCII text-based file that controls many of the switch parameters. Open the file and delete all references to RIP. You must reboot the switch when this is complete.

Note. In simple networks where only IP forwarding is required, you need not use RIP. If you are not using RIP, it is best not to load it to save switch resources.

Enabling RIP

RIP is disabled by default. Use the **ip rip admin-state** command to enable RIP routing on the switch. For example:

```
-> ip rip admin-state enable
```

Use the **ip rip admin-state disable** command to disable RIP routing on the switch. Use the **show ip rip** command to display the current RIP status.

Creating a RIP Interface

You must create a RIP interface on a VLAN's IP router interface to enable RIP routing. Enter the **ip rip interface** command followed by the name of the VLAN router port. For example, to create a RIP interface on a router port with a name of rip-1 you would enter:

```
-> ip rip interface rip-1
```

Use the **no ip rip interface** command to delete a RIP interface. Use the **show ip rip interface** command to display configuration and error information for a RIP interface.

Note. You can create a RIP interface even if an IP router interface has not been configured. However, RIP does not function unless a RIP interface is created and enabled on an IP router interface. See [Chapter 4, "Configuring VLANs,"](#) and [Chapter 16, "Configuring IP,"](#) for more information.

Enabling a RIP Interface

Once you have created a RIP interface, you must enable it to enable RIP routing. Use the **ip rip interface admin-state** command followed by the interface IP address to enable a RIP interface. For example, to enable RIP routing on a RIP interface rip-1 you must enter:

```
-> ip rip interface rip-1 admin-state enable
```

To disable an RIP interface, use the **disable** keyword with the **ip rip interface admin-state** command. For example to disable RIP routing on a RIP interface rip-1 you would enter:

```
-> ip rip interface rip-1 admin-state disable
```

Configuring the RIP Interface Send Option

The RIP Send option defines the type(s) of RIP packets that the interface sends. Using this command overrides RIP default behavior. Other devices must be able to interpret the information provided by this command or routing information is not properly exchanged between the switch and other devices on the network.

Use the **ip rip interface send-version** command to configure an individual RIP interface Send option. Enter the IP address of the RIP interface, and then enter a Send option. For example, to configure a RIP interface rip-1 to send only RIPv1 packets you would enter:

```
-> ip rip interface rip-1 send-version v1
```

The Send options are:

- **v1.** Only RIPv1 packets is sent by the switch.

- **v2.** Only RIPv2 packets is sent by the switch.
- **v1compatible.** Only RIPv2 broadcast packets (not multicast) is sent by the switch.
- **none.** Interface does not forward RIP packets.

To set the default RIP send option use the **ip rip interface send-version** command.

Use the **show ip rip interface** command to display the current interface send option.

Configuring the RIP Interface Receive Option

The RIP Receive option defines the type(s) of RIP packets that the interface accepts. Using this command overrides RIP default behavior. Other devices must be able to interpret the information provided by this command or routing information is not properly exchanged between the switch and other devices on the network.

Use the **ip rip interface recv-version** command to configure an individual RIP interface Receive option. Enter the IP address of the RIP interface, and then enter a Receive option. For example, to configure RIP interface rip-1 to receive only RIPv1 packets you would enter:

```
-> ip rip interface rip-1 recv-version v1
```

The Receive options are:

- **v1.** Only RIPv1 packets is received by the switch.
- **v2.** Only RIPv2 packets is received by the switch.
- **both.** Both RIPv1 and RIPv2 packets is received by the switch.
- **none.** Interface ignores any RIP packets received.

To set the default RIP receive option use the **ip rip interface recv-version** command.

Configuring the RIP Interface Metric

You can set priorities for routes generated by a switch by assigning a metric value to routes generated by that switch's RIP interface. For example, routes generated by a neighboring switch can have a hop count of 1. However, you can lower the priority of routes generated by that switch by increasing the metric value for routes generated by the RIP interface.

Note. When you configure a metric for a RIP interface, this metric cost is added to the metric of the incoming route.

Use the **ip rip interface metric** command to configure the RIP metric or cost for routes generated by a RIP interface. Enter the IP address of the RIP interface as well as a metric value. For example, to set a metric value of 2 for the RIP interface rip-1 you would enter:

```
-> ip rip interface rip-1 metric 2
```

The valid metric range is **1** to **15**. To change the default value use the **ip rip interface metric** command.

Use the **show ip rip interface** command to display the current interface metric.

Configuring the RIP Interface Route Tag

Use the **ip rip route-tag** command to configure a route tag value for routes generated by the RIP interface. This value is used to set priorities for RIP routing. Enter the command and the route tag value. For example, to set a route tag value of 1 you would enter:

```
-> ip rip route-tag 1
```

The valid route tag value range is **1** to **2147483647**.

Use the **show ip rip** command to display the current route tag value.

RIP Options

The following sections detail procedures for configuring RIP options. RIP must be loaded and enabled on the switch before you can configure any of the RIP configuration options.

Configuring the RIP Forced Hold-Down Interval

The RIP forced hold-down timer value defines an amount of time, in seconds, during which routing information regarding better paths is suppressed. A route enters into a forced hold-down state when an update packet is received that indicates the route is unreachable and when this timer is set to a non-zero value. After this timer has expired and if the value is less than 120 seconds, the route enters a hold-down state for the rest of the period until the remainder of the 120 seconds has also expired. During this time the switch accepts any advertisements for better paths that are received.

Note that the RIP forced hold-down timer is *not* the same as the RIP hold-down timer. The forced hold-down timer defines a separate interval that overlaps the hold-down state. During the forced hold-down timer interval, the switch does not accept *better* routes from other gateways. For more information on RIP hold-down timer, see [“Configuring the RIP Hold-Down Timer” on page 20-10](#).

Use the **ip rip force-holddowntimer** command to configure the interval during which a RIP route remains in a forced hold-down state. Enter the command and the forced hold-down interval value, in seconds. For example, to set a forced hold-down interval value of 10 seconds you would enter:

```
-> ip rip force-holddowntimer 10
```

The valid forced hold-down timer range is **0** to **120**.

Use the **show ip rip** command to display the current forced hold-down timer value.

Configuring the RIP Update Interval

The RIP update interval defines the time interval, in seconds, when routing updates are sent out. This interval value must be less than or equal to one-third the value of the invalid timer.

Use the **ip rip update-interval** command to configure the interval during which a RIP route remains in an update state. Enter the command and the update interval value, in seconds. For example, to set an update-interval value of 45 seconds, you would enter:

```
-> ip rip update-interval 45
```

The valid update interval range is **1** to **120**.

Configuring the RIP Invalid Timer

The RIP invalid timer value defines the time interval, in seconds, during which a route remains active in the Routing Information Base (RIB) before it is moved to the invalid state. This timer value must be at least three times the update interval value.

Use the `ip rip invalid-timer` command to configure the time interval that must elapse before an active route becomes invalid. Enter the command and the invalid timer value, in seconds. For example, to set an invalid interval value of 270 seconds you would enter:

```
-> ip rip invalid-timer 270
```

The invalid timer range is **3** to **360**.

Configuring the RIP Garbage Timer

The RIP garbage timer defines the time interval, in seconds, that must elapse before an expired route is removed from the RIB.

Note that during the garbage interval, the router advertises the route with a metric of INFINITY.

Use the `ip rip garbage-timer` command to configure the time interval after which an expired route is removed from the RIB. Enter the command and the garbage timer value, in seconds. For example, to set a garbage timer value of 180 seconds you would enter:

```
-> ip rip garbage-timer 180
```

The garbage timer range is **0** to **180**.

Configuring the RIP Hold-Down Timer

The RIP hold-down timer defines the time interval, in seconds, during which a route remains in the holddown state.

Whenever RIP detects a route with a higher metric than the route in the RIB, the route with the higher metric goes into the hold-down state. The route updates with a metric of INFINITY are excluded.

Use the `ip rip holddown-timer` command to configure the interval during which a RIP route remains in the hold-down state. Enter the command and the hold-down timer value, in seconds. For example, to set a hold-down timer value of 10 seconds you would enter:

```
-> ip rip holddown-timer 10
```

The hold-down timer range is **0** to **120**.

Reducing the Frequency of RIP Routing Updates

To optimize system performance, you can reduce the frequency of the RIP routing updates by increasing the length of the update, invalid, and garbage timers by about 50% above their default values. For example:

```
-> ip rip update-interval 45
-> ip rip invalid-timer 270
-> ip rip garbage-timer 180
```

Enabling a RIP Host Route

A host route differs from a network route, which is a route to a specific network. This command allows a direct connection to the host without using the RIP table. If a switch is directly attached to a host on a network, use the **ip rip host-route** command to enable a default route to the host. For example:

```
-> ip rip host-route
```

The default is to enable a default host route.

Use the **no ip rip host-route** command to disable the host route. Use the **show ip rip** command to display the current host route status.

Configuring Redistribution

It is possible to configure the RIP protocol to advertise routes learned from other routing protocols into the RIP network. Such a process is referred to as route redistribution and is configured using the **ip service source-ip** command.

Redistribution uses route maps to control how external routes are learned and distributed. A route map consists of one or more user-defined statements that can determine which routes are allowed or denied access to the RIP network. In addition a route map can also contain statements that modify route parameters before they are redistributed.

When a route map is created, it is given a name to identify the group of statements that it represents. This name is required by the **ip redistrib** command. Therefore, configuring route redistribution involves the following steps:

- 1 Create a route map, as described in [“Using Route Maps” on page 20-12](#).
- 2 Configure redistribution to apply a route map, as described in [“Configuring Route Map Redistribution” on page 20-16](#).

Using Route Maps

A route map specifies the criteria that are used to control redistribution of routes between protocols. Such criteria is defined by configuring route map statements. There are three different types of statements:

- **Action.** An action statement configures the route map name, sequence number, and whether or not redistribution is permitted or denied based on route map criteria.
- **Match.** A match statement specifies criteria that a route must match. When a match occurs, then the action statement is applied to the route.
- **Set.** A set statement is used to modify route information before the route is redistributed into the receiving protocol. This statement is only applied if all the criteria of the route map is met and the action permits redistribution.

The **ip route-map** command is used to configure route map statements and provides the following **action**, **match**, and **set** parameters:

ip route-map action ...	ip route-map match ...	ip route-map set ...
permit deny	ip-address ip-nexthop ipv6-address ipv6-nexthop tag ipv4-interface ipv6-interface metric route-type	metric metric-type tag community local-preference level ip-nexthop ipv6-nexthop

Refer to the “IP Commands” chapter in the *OmniSwitch CLI Reference Guide* for more information about the **ip route-map** command parameters and usage guidelines.

Once a route map is created, it is then applied using the **ip service source-ip** command. See [“Configuring Route Map Redistribution” on page 20-16](#) for more information.

Creating a Route Map

When a route map is created, it is given a name (up to 20 characters), a sequence number, and an action (permit or deny). Specifying a sequence number is optional. If a value is not configured, then the number 50 is used by default.

To create a route map, use the **ip route-map** command with the **action** parameter. For example,

```
-> ip route-map ospf-to-rip sequence-number 10 action permit
```

The above command creates the ospf-to-rip route map, assigns a **sequence number** of 10 to the route map, and specifies a **permit** action.

To optionally filter routes before redistribution, use the **ip route-map** command with a **match** parameter to configure match criteria for incoming routes. For example,

```
-> ip route-map ospf-to-rip sequence-number 10 match tag 8
```

The above command configures a match statement for the ospf-to-rip route map to filter routes based on their tag value. When this route map is applied, only OSPF routes with a tag value of eight are redistributed into the RIP network. All other routes with a different tag value are dropped.

Note. Configuring match statements is not required. However, if a route map does not contain any match statements and the route map is applied using the **ip service source-ip** command, the router redistributes *all* routes into the network of the receiving protocol.

To modify route information before it is redistributed, use the **ip route-map** command with a **set** parameter. For example,

```
-> ip route-map ospf-to-rip sequence-number 10 set tag 5
```

The above command configures a set statement for the ospf-to-rip route map that changes the route tag value to five. Because this statement is part of the ospf-to-rip route map, it is only applied to routes that have an existing tag value equal to eight.

The following is a summary of the commands used in the above examples:

```
-> ip route-map ospf-to-rip sequence-number 10 action permit
-> ip route-map ospf-to-rip sequence-number 10 match tag 8
-> ip route-map ospf-to-rip sequence-number 10 set tag 5
```

To verify a route map configuration, use the **show ip route-map** command:

```
-> show ip route-map
Route Maps: configured: 1 max: 200
Route Map: ospf-to-rip Sequence Number: 10 Action permit
  match tag 8
  set tag 5
```

Deleting a Route Map

Use the **no** form of the **ip route-map** command to delete an entire route map, a route map sequence, or a specific statement within a sequence.

To delete an entire route map, enter **no ip route-map** followed by the route map name. For example, the following command deletes the entire route map named `redistipv4`:

```
-> no ip route-map redistipv4
```

To delete a specific sequence number within a route map, enter **no ip route-map** followed by the route map name, then **sequence-number** followed by the actual number. For example, the following command deletes sequence 10 from the `redistipv4` route map:

```
-> no ip route-map redistipv4 sequence-number 10
```

Note that in the above example, the `redistipv4` route map is not deleted. Only those statements associated with sequence 10 are removed from the route map.

To delete a specific statement within a route map, enter **no ip route-map** followed by the route map name, then **sequence-number** followed by the sequence number for the statement, then either **match** or **set** and the match or set parameter and value. For example, the following command deletes only the match tag 8 statement from route map `redistipv4` sequence 10:

```
-> no ip route-map redistipv4 sequence-number 10 match tag 8
```

Configuring Route Map Sequences

A route map consists of one or more sequences of statements. The sequence number determines which statements belong to which sequence and the order in which sequences for the same route map are processed.

To add match and set statements to an existing route map sequence, specify the same route map name and sequence number for each statement. For example, the following series of commands creates route map `rm_1` and configures match and set statements for the `rm_1` sequence 10:

```
-> ip route-map rm_1 sequence-number 10 action permit
-> ip route-map rm_1 sequence-number 10 match tag 8
-> ip route-map rm_1 sequence-number 10 set metric 1
```

To configure a new sequence of statements for an existing route map, specify the same route map name but use a different sequence number. For example, the following command creates a new sequence 20 for the `rm_1` route map:

```
-> ip route-map rm_1 sequence-number 20 action permit
-> ip route-map rm_1 sequence-number 20 match ipv4-interface to-finance
-> ip route-map rm_1 sequence-number 20 set metric 5
```

The resulting route map appears as follows:

```
-> show ip route-map rm_1
Route Map: rm_1 Sequence Number: 10 Action permit
  match tag 8
  set metric 1
Route Map: rm_1 Sequence Number: 20 Action permit
  match ipv4 interface to-finance
  set metric 5
```

Sequence 10 and sequence 20 are both linked to route map `rm_1` and are processed in ascending order according to their sequence number value. Note that there is an implied logical OR between sequences. As a result, if there is no match for the tag value in sequence 10, then the match interface statement in sequence 20 is processed. However, if a route matches the tag 8 value, then sequence 20 is not used. The set statement for whichever sequence was matched is applied.

A route map sequence contains multiple match statements. If these statements are of the same kind (for example, match tag 5, match tag 8, etc.) then a logical OR is implied between each like statement. If the match statements specify different types of matches (for example match tag 5, match ip4 interface to-finance, etc.), then a logical AND is implied between each statement. For example, the following route map sequence redistributes a route if its tag is either 8 or 5:

```
-> ip route-map rm_1 sequence-number 10 action permit
-> ip route-map rm_1 sequence-number 10 match tag 5
-> ip route-map rm_1 sequence-number 10 match tag 8
```

The following route map sequence redistributes a route if the route has a tag of 8 or 5 *and* the route was learned on the IPv4 interface to-finance:

```
-> ip route-map rm_1 sequence-number 10 action permit
-> ip route-map rm_1 sequence-number 10 match tag 5
-> ip route-map rm_1 sequence-number 10 match tag 8
-> ip route-map rm_1 sequence-number 10 match ipv4-interface to-finance
```

Configuring Access Lists

An IP access list provides a convenient way to add multiple IPv4 or IPv6 addresses to a route map. Using an access list avoids having to enter a separate route map statement for each individual IP address. Instead, a single statement is used that specifies the access list name. The route map is then applied to all the addresses contained within the access list.

Configuring an IP access list involves two steps: creating the access list and adding IP addresses to the list. To create an IP access list, use the **ip access-list** command (IPv4) or the **ipv6 access-list** command (IPv6) and specify a name to associate with the list. For example,

```
-> ip access-list ipaddr
-> ipv6 access-list ip6addr
```

To add addresses to an access list, use the **ip access-list address** (IPv4) or the **ipv6 access-list address** (IPv6) command. For example, the following commands add addresses to an existing access list:

```
-> ip access-list ipaddr address 16.24.2.1/16
-> ipv6 access-list ip6addr address 2001::1/64
```

Use the same access list name each time the above commands are used to add additional addresses to the same access list. In addition, both commands provide the ability to configure if an address and/or its matching subnet routes are permitted (the default) or denied redistribution. For example:

```
-> ip access-list ipaddr address 16.24.2.1/16 action deny redistrib-control all-
subnets
-> ipv6 access-list ip6addr address 2001::1/64 action permit redistrib-control no-
subnets
```

For more information about configuring access list commands, see the “IP Commands” chapter in the *OmniSwitch AOS Release 8 CLI Reference Guide*.

Configuring Route Map Redistribution

The **ip service source-ip** command is used to configure the redistribution of routes from a source protocol into the RIP destination protocol. This command is used on the RIP router that performs the redistribution.

A source protocol is a protocol from which the routes are learned. A destination protocol is the one into which the routes are redistributed. Make sure that both protocols are loaded and enabled before configuring redistribution.

Redistribution applies criteria specified in a route map to routes received from the source protocol. Therefore, configuring redistribution requires an existing route map. For example, the following command configures the redistribution of OSPF routes into the RIP network using the ospf-to-rip route map:

```
-> ip redistrib ospf into rip route-map ospf-to-rip
```

RIP routes received by the router interface are processed based on the contents of the ospf-to-rip route map. Routes that match criteria specified in this route map are either allowed or denied redistribution into the RIP network. The route map can also specify the modification of route information before the route is redistributed. See [“Using Route Maps” on page 20-12](#) for more information.

To remove a route map redistribution configuration, use the **no** form of the **ip redistrib** command. For example:

```
-> no ipv6 redistrib ospf into rip route-map ospf-to-rip
```

Use the **show ip redistrib** command to verify the redistribution configuration:

```
-> show ip redistrib
```

Source Protocol	Destination Protocol	Status	Route Map
LOCAL4	RIP	Enabled	rip_1
LOCAL4	OSPF	Enabled	ospf_2
LOCAL4	BGP	Enabled	bgp_3
RIP	OSPF	Enabled	ospf-to-rip

Configuring the Administrative Status of the Route Map Redistribution

The administrative status of a route map redistribution configuration is enabled by default. To change the administrative status, use the **status** parameter with the **ip redistrib** command. For example, the following command disables the redistribution administrative status for the specified route map:

```
-> ip redistrib ospf into rip route-map ospf-to-rip admin-state disable
```

The following command example enables the administrative status:

```
-> ip redistrib ospf into rip route-map ospf-to-rip admin-state enable
```

Route Map Redistribution Example

The following example configures the redistribution of OSPF routes into a RIP network using a route map (ospf-to-rip) to filter specific routes:

```
-> ip route-map ospf-to-rip sequence-number 10 action deny
-> ip route-map ospf-to-rip sequence-number 10 match tag 5
-> ip route-map ospf-to-rip sequence-number 10 match route-type external type2

-> ip route-map ospf-to-rip sequence-number 20 action permit
-> ip route-map ospf-to-rip sequence-number 20 match ipv4-interface intf_ospf
-> ip route-map ospf-to-rip sequence-number 20 set metric 255

-> ip route-map ospf-to-rip sequence-number 30 action permit
-> ip route-map ospf-to-rip sequence-number 30 set tag 8

-> ipv6 redist ospf into rip route-map ospf-to-rip
```

The resulting ospf-to-rip route map redistribution configuration does the following:

- Denies the redistribution of Type 2 external OSPF routes with a tag set to five.
- Redistributes into RIP all routes learned on the intf_ospf interface and sets the metric for such routes to 255.
- Redistributes into RIP all other routes (those not processed by sequence 10 or 20) and sets the tag for such routes to eight.

RIP Security

By default, there is no authentication used for a RIP. However, you can configure a password for a RIP interface. To configure a password, you must first select the authentication type (simple or MD5), and then configure a password.

Configuring Authentication Type

If simple or MD5 password authentication is used, both switches on either end of a link must share the same password. Use the **ip rip interface auth-type** command to configure the authentication type. Enter the name of the RIP interface, and then enter an authentication type:

- **none.** No authentication is used.
- **simple.** Simple password authentication is used.
- **md5.** MD5 authentication is used.

For example, to configure the RIP interface rip-1 for simple authentication you would enter:

```
-> ip rip interface rip-1 auth-type simple
```

To configure the RIP interface rip-1 for MD5 authentication you would enter:

```
-> ip rip interface rip-1 md5 auth-type md5
```

Configuring Passwords

If you configure simple or MD5 authentication you must configure a text string that is used as the password for the RIP interface. If a password is used, all switches that are intended to communicate with each other must share the same password.

After configuring the interface for simple authentication as described above, configure the password for the interface by using the **ip rip interface auth-key** command. Enter the IP address of the RIP interface, and then enter a 16-byte text string. For example to configure a password “nms” you would enter:

```
-> ip rip interface rip-1 auth-key nms
```

Verifying the RIP Configuration

A summary of the show commands used for verifying the RIP configuration is given here:

show ip rip	Displays the RIP status and general configuration parameters (for example, forced hold-down timer).
show ip rip routes	Displays the RIP routing database. The routing database contains all the routes learned through RIP.
show ip rip interface	Displays the RIP interface status and configuration.
show ip rip peer	Displays active RIP neighbors (peers).
show ip redistrib	Displays the currently configured RIP redistribution filters.

For more information about the displays that result from these commands, see the *OmniSwitch AOS Release 8 CLI Reference Guide*.

21 Configuring BFD

An increasingly important requirement of networking equipment is to rapidly detect communication failures between network systems to quickly establish alternative paths and reduce network convergence time. Data link hardware such as SONET alarms make failure detection fairly easy and quick. However, some media, such as Ethernet, do not support such kind of signaling, and some media can not detect certain kinds of failures in the path, such as failing interfaces or forwarding engine components.

In the absence of such signaling hardware, networks resort to using simple “Hello” mechanisms to detect failures in the communication pathways between adjacent systems. One such mechanism is the Bidirectional Forwarding Detection (BFD) protocol.

BFD protocol is a fairly simple and quick Hello protocol; it can be configured on the interfaces with routing protocols to rapidly detect faults in the bidirectional paths between adjacent forwarding engines, including data link(s) and forwarding engines. BFD is not intended to directly control liveness information; instead, the application provides parameters and BFD supplies the state of the session. It acts in an advisory role to the control protocols. It provides a low overhead alternative to detect faults for all media types and routing protocols in a variety of network environments and topologies. BFD protocol sessions can be initiated for any remote IP address reachable through outgoing IP interface ports.

In This Chapter

This chapter describes the basic components of BFD and how to configure them through the Command Line Interface (CLI). CLI commands are used in the configuration examples; for more details about the syntax of commands, see the *OmniSwitch AOS Release 8 CLI Reference Guide*.

Configuration procedures described in this chapter include:

- Global Configuration (see [page 21-12](#)).
- Interface Level Configuration (see [page 21-12](#)).
- OSPF level configuration (see [page 21-16](#)).
- BGP Level Configuration (see [page 21-18](#)).
- VRRP Level Configuration (see [page 21-20](#)).
- Static Routing Level Configuration (see [page 21-22](#)).

BFD Specifications

RFCs Supported	5880—Bidirectional Forwarding Detection 5881—Bidirectional Forwarding Detection for IPv4 and IPv6 (Single Hop) 5882—Generic Application of Bidirectional Forwarding Detection
Platforms Supported	OmniSwitch 6860, 6860E
Maximum Number of BFD Sessions	Chassis - 32 Virtual Chassis - 100
Protocols Supported	BGP, OSPF, VRRP Remote Address Tracking only, and Static Routes. IPv6 protocols not supported.
Modes Supported	Asynchronous Echo (Demand Mode not supported)

BFD Defaults

The following table shows the default settings of the configurable BFD parameters.

Parameter Description	Command	Default Value/Comments
BFD global status for the switch	ip bfd admin-state	Disabled
Global transmit time interval for BFD control packets	ip bfd transmit	300 milliseconds
Global receive time interval for BFD control packets.	ip bfd receive	300 milliseconds
Global BFD detection time multiplier	ip bfd multiplier	3
Global BFD echo packet time interval	ip bfd echo-interval	300 milliseconds
Administrative status of a BFD interface	ip bfd interface admin-state	Disabled
Transmit time interval for a BFD interface.	ip bfd interface transmit	300 milliseconds
Receive time interval for the BFD interface.	ip bfd interface receive	300 milliseconds
BFD interface detection time multiplier.	ip bfd interface multiplier	3
Echo time interval for the BFD interface	ip bfd interface echo-interval	300 milliseconds
BFD status for the OSPF protocol	ip ospf bfd-state	Disabled
BFD status for an OSPF interface	ip ospf interface bfd-state	Disabled
BFD session status with all BGP neighbors	ip bgp bfd-state all-neighbors	Disabled

Parameter Description	Command	Default Value/Comments
BFD session status with all neighbors of the corresponding interface which are greater than or equal to “2-way” state	ip ospf interface bfd-state all-neighbors	Enabled
BFD status for the BGP protocol	ip bgp bfd-state	Disabled
BFD status for BGP neighbors	ip bgp neighbor bfd-state	Disabled
BFD status for VRRP protocol	vrrp bfd-state	Disabled
BFD status for a VRRP tracking policy.	vrrp track address bfd-state	Enabled
BFD status for a static route.	ip static-route bfd-state	Enabled

Quick Steps for Configuring BFD

Configuring BFD involves:

- *Optional:* Configuring BFD explicitly on the IP interfaces.
- Configuring Layer 3 protocols to use BFD (see “[Quick Steps for Configuring BFD Support for Layer 3 Protocols](#)” on page 21-5).

Note. Configuring a BFD session explicitly with an IP interface name is optional, and must be used if user defined BFD session parameters need to be applied. All the steps for explicit configuration are mentioned as optional.

If BFD is not explicitly configured, the default BFD global session parameters (transmit, receive and echo intervals) are applied to the BFD sessions.

The following steps provide a brief tutorial for configuring a BFD session and related parameters:

- 1** Configure a BFD session on IP interface using the **ip bfd interface** command. For example:

```
-> ip bfd interface
```

Optional: Configure the BFD session explicitly with an IP interface name if non-default BFD session parameters are required for BFD sessions that must be run separate from the IP interface.

```
-> ip bfd interface bfd_int_1
```

- 2** *Optional:* Configure a global transmit time interval for all BFD sessions using the **ip bfd transmit** command. This command defines a default transmit value that is automatically applied when a BFD session is created. For example:

```
-> ip bfd transmit 500
```

- 3** *Optional:* Configure the transmit time interval for a specific BFD session using the **ip bfd interface transmit** command. The value set with this command overrides the global transmit value configured for the routing instance. For example:

```
-> ip bfd interface bfd-vlan-101 transmit 500
```

4 *Optional*: Configure a global receive time interval for all BFD sessions using the **ip bfd receive** command. This command defines a default receive time value that is automatically applied when a BFD session is created. For example:

```
-> ip bfd receive 500
```

5 *Optional*: Configure the receive time interval for a specific BFD session using the **ip bfd interface receive** command. The value set with this command overrides the global receive time value configured for the routing instance:

```
-> ip bfd interface bfd-vlan-101 receive 500
```

6 *Optional*: Configure a global detection time multiplier value for all BFD sessions using the **ip bfd multiplier** command. For example:

```
-> ip bfd multiplier 5
```

7 *Optional*: Configure the BFD session detection time multiplier value using the **ip bfd interface multiplier** command. For example:

```
-> ip bfd interface bfd-vlan-101 multiplier 5
```

Note. Demand mode is not supported. The default operational mode is Asynchronous with the echo function enabled. However, Static Routing and VRRP protocol support BFD in the echo-only operational mode.

8 *Optional*: Configure the global BFD echo packet time interval using the **ip bfd echo-interval** command. This command defines a default echo packet time value that is automatically applied when a BFD session is created. For example:

```
-> ip bfd echo-interval 500
```

9 *Optional*: Configure the echo time interval for a specific BFD session using the **ip bfd interface echo-interval** command. The echo time interval value set with this command overrides the global echo time interval configured for the routing instance. For example:

```
-> ip bfd interface bfd-vlan-101 echo-interval 500
```

10 *Optional*: Enable the administrative status of a BFD interface using the **ip bfd interface admin-state** command. For example:

```
-> ip bfd interface bfd-vlan-101 admin-state enable
```

Note. BFD parameters are not configurable once the BFD administrative status is enabled on the interface.

11 Enable the BFD protocol for the routing instance globally using the **ip bfd admin-state** command. For example:

```
-> ip bfd admin-state enable
```

Note. *Optional.* Verify the BFD interface session status and configuration using the **show ip bfd interfaces** command. For example:

```
-> show ip bfd interfaces one
Interface Name           = one,
Interface IP Address     = 100.1.1.1,
Admin Status             = Enabled,
Desired Transmit Interval = 300,
Minimum Receive Interval = 300,
Detection Time Multiplier = 3,
Minimum Echo Receive Interval = 300,
Authentication Present   = No,
Oper Status              = UP
```

To verify the global BFD configuration for the switch, use the **show ip bfd** command. For example:

```
-> show ip bfd
BFD Version Number      = 1,
Admin Status            = Enabled,
Desired Transmit Interval = 300,
Minimum Receive Interval = 300,
Detection Time Multiplier = 3,
Minimum Echo Receive Interval = 300,
Applications Registered = STATIC-ROUTING OSPF PIM DVMRP
```

See the “BFD Commands” chapter in the *OmniSwitch AOS Release 8 CLI Reference Guide* for information about the fields in this display.

Quick Steps for Configuring BFD Support for Layer 3 Protocols

BFD runs on top of Layer 3 protocol traffic that is forwarded between two systems. This implementation of BFD supports the following protocols:

- BGP
- OSPF
- VRRP Tracking
- Static routes

Once the BFD configuration is in place (see “Quick Steps for Configuring BFD” on page 21-3), the steps described in the following sections are used to configure BFD interaction with the supported Layer 3 protocols.

Configuring BFD Support for OSPF

1 Register OSPF with the BFD protocol using the **ip ospf bfd-state** command. For example:

```
-> ip ospf bfd-state enable
```

2 Enable BFD session on specific OSPF interface using the **ip ospf interface bfd-state** command or on all OSPF interfaces using the **ip ospf bfd-state all-interfaces** command. For example:

```
-> ip ospf interface int1 bfd-state enable
-> ip ospf bfd-state all-interfaces
```

3 Establish BFD sessions with all OSPF DR neighbors in full states only or with all neighbors greater than or equal to the “2-way” state using the **ip ospf interface bfd-state drs-only** command or the **ip ospf**

interface bfd-state all-neighbors command. For example:

```
-> ip ospf interface int1 bfd-state drs-only
-> ip ospf interface int1 bfd-state all-neighbors enable
```

Configuring BFD Support for BGP

1 Register BGP with the BFD protocol using the **ip bgp bfd-state** command. For example:

```
-> ip bgp bfd-state enable
```

2 Enable BFD for specific BGP neighbors using the **ip bgp neighbor bfd-state** command or for all BGP neighbors using the **ip bgp bfd-state all-neighbors** command. For example:

```
-> ip bgp neighbor 135.10.10.2 bfd-state enable
-> ip bgp bfd-state all-neighbors enable
```

Configuring BFD Support for VRRP Track Policies

1 Register VRRP with the BFD protocol using the **vrrp bfd-state** command. For example:

```
-> vrrp bfd-state enable
```

2 Enable BFD for a specific track policy using the **vrrp track address bfd-state** command. For example:

```
-> vrrp track 2 address 10.1.1.1 bfd-state enable
```

Make sure that the track policy is associated with at least one of the virtual routers. In addition, note that the value of the address parameter must be a remote interface address. BFD cannot be configured for a local interface address.

Note. To display the VRRP tracking policies on which BFD is enabled, use the **show vrrp track** command.

```
-> show vrrp track
Track
ID          Policy          Admin      Oper      BFD
           State          State      Pri      Status
-----+-----+-----+-----+-----+-----
  1    25.25.25.1      Enabled    Down     50     Enabled
  2    192.10.150.42   Enabled    Down     25     Enabled
```

See the “VRRP Commands” chapter in the *OmniSwitch AOS Release 8 CLI Reference Guide* for information about the fields in this display.

Configuring BFD Support for Static Routes

Enable BFD support for a specific static route using the **ip static-route bfd-state** command or for all static routes using the **ip static-route all bfd-state** command. For example:

```
-> ip static-route 192.100.1.0/24 gateway 100.1.1.10 bfd-state enable
-> ip static-route all bfd-state enable
```

To create a BFD session for a static route, make sure that:

- the gateway address does not match any of the local interface addresses on the switch
- BFD is enabled on the interface on which the gateway address exists.
- if multiple routes are configured with the same gateway address, only one BFD session is run.

Note. To display the static routes on which BFD is enabled use the **show ip router database** command along with the **protocol static** option. For example:

```
-> ip static-route 100.0.0.0/8 gateway 100.1.1.10 bfd-state enable
-> show ip router database protocol static
```

```
Legend: + indicates routes in-use
         b indicates BFD-enabled static route
         r indicates recursive static route, with following address in brackets
```

```
Total IPRM IPv4 routes: 7
```

Destination	Gateway	Interface	Protocol	Metric	Tag	Misc-Info
+b 100.0.0.0/8	100.1.1.10	v1001	STATIC	1	0	
+ 128.251.40.0/24	172.28.4.254	EMP	STATIC	1	0	

```
Inactive Static Routes
```

Destination	Gateway	Metric

See the “IP Commands” chapter in the *OmniSwitch AOS Release 8 CLI Reference Guide* for information about the fields in this display.

BFD Overview

Detecting communication failures as soon as possible is the first step in any network recovery process; until a failure is detected, network convergence can't begin. By rapidly detecting failures, BFD enables faster convergence of routing protocols particularly on shared media such as ethernet.

The BFD protocol is very similar to the widely-used Hello mechanisms prevalent in a majority of routing protocols, with the exception that BFD tests bidirectional communication links, has smaller packets, and is focused exclusively on path-failure detection. BFD can also be less CPU-intensive in routers with distributed architecture because unlike routing protocol Hello packets, BFD packets can be processed on the interface modules rather than the control plane.

BFD protocol is a fairly simple Hello protocol designed to provide fast forwarding path failure detection that can be enabled at the interface and routing protocol levels. It helps in the verification of forwarding plane-to-forwarding plane connectivity (including links, interfaces, tunnels). It allows semantic separation of forwarding plane connectivity and control plane connectivity. BFD is a single mechanism that works independently of underlying media, data, and network protocols. It can be associated with any routing protocol running between two systems. Moreover, it requires no changes to the existing protocols.

This implementation of BFD can be associated with tracking of next hops with the BGP, OSPF, VRRP and other static route protocols.

Benefits of Using BFD For Failure Detection

It is more advantageous to implement BFD rather than reduce timer mechanisms for routing protocols due to the following reasons:

- BFD can detect failures in milliseconds without having to fine-tune routing protocol Hello timers.
- BFD is not tied to any particular routing protocol. As a result, BFD provides a generic and consistent failure detection mechanism for OSPF, BGP, VRRP Remote Tracking, and static routes.
- BFD is less CPU-intensive than reduced timer mechanisms for routing protocols.

How the BFD Protocol Works

A BFD session must be explicitly configured between two adjacent systems. Once BFD has been enabled on the interfaces and at the appropriate Layer 3 routing protocol level, a BFD session is created for the adjacent systems and BFD timers are negotiated between these systems.

The BFD protocol does not have a neighbor discovery mechanism to detect neighboring systems; protocols that BFD services notify BFD of devices to which it needs to establish sessions. For example, an OSPF implementation can request BFD to establish a session with a neighbor discovered using the OSPF Hello protocol.

Once a session is established, BFD peers - neighboring systems sharing a BFD interface - begin sending BFD control packets to each other over the bidirectional forwarding path. The packets are transmitted periodically at the negotiated rate. The BFD control packets function in a similar manner to that of an IGP Hello protocol, except at a more accelerated rate.

Each time a BFD control packet is successfully received through a BFD interface, the detect-timer for that session is reset to zero. As long as the BFD peer systems receive the control packets from each other within the negotiated time interval $[(\text{Detect Time Multiplier}) * (\text{Required Minimum Rx Interval})]$, the BFD session remains up. Any routing protocol that associates the BFD maintains its adjacencies and continues its periodic transmission of BFD control packets at the negotiated rate.

In case a system stops receiving the packets within the predetermined time frame, some component in the bidirectional path to that particular system is assumed to have failed, and the BFD system simply informs its client protocol that a failure has occurred. It does this by sending rapid failure detection notices to respective registered routing protocols in the local router to initiate the router table recalculation process in order to accelerate routing convergence and network uptime.

In order to agree with its peers about how rapidly failure detection takes place, each system estimates the rate at which it can send and receive BFD control packets. This design also enables fast systems on shared medium with a slow system to detect failures more rapidly between fast systems while allowing the slow system to participate to the best of its ability.

Operational Mode and Echo Function

The BFD protocol offers two different modes of operation:

- Asynchronous mode
- Demand mode (not supported)

This implementation of BFD supports the Asynchronous mode. In this mode, BFD neighbors periodically send BFD control packets to each other. A time interval for transmitting and receiving such packets is negotiated between the two BFD systems. If a neighboring system fails to receive a number of control packets continuously over a specific period of time, the session is considered down and BFD informs the appropriate routing protocol.

In addition to the operational mode, an Echo function is available to verify the forwarding path between neighboring BFD systems. When enabled, a BFD system transmits Echo packets to a BFD neighbor, which then sends the packets back to the originating system along the forwarding path. If no Echo packets are received back from the BFD neighbor within a configured Echo time interval, the session is considered down.

The Echo function is a configurable option and can work on its own or simultaneously with the Asynchronous mode. Note that using the Echo function with the Asynchronous mode lowers the rate at which control packets are sent because Echo packets are then used to detect session liveness. In addition, transmitting Echo packets is only allowed over a single hop; transmitting BFD control packets is allowed over multiple hops.

Once a BFD session is started, the BFD peers can decide whether or not Echo packets are actually transmitted. A session is considered down when the peers receive no BFD control packets from each other or if sufficient Echo packets are missed within a specific period of time.

BFD Packet Formats

The detection packets BFD sends are UDP packets which are of two types: BFD control packets and Echo packets.

BFD Control Packets

There is no specific encapsulation type for BFD control packets; instead, the BFD IETF RFC-5880 recommends an encapsulation type that is “appropriate to the medium and network” used. This implementation of BFD for IPv4 routing protocols (BGP, OSPF, VRRP Remote Tracking, and static routes), associates BFD control packets in UDP packets using destination port 3784 and a source port in the range of 49152 to 65535.

Note. The BFD control packet has a mandatory section and an optional authentication section. Authentication is not supported in this implementation of the BFD protocol.

BFD Echo Packets

There is no specific definition for Echo packet format. The only requirement is that the transmitting system is able to use the packet contents to distinguish between the various BFD sessions so that packets are correctly processed for the appropriate session.

This implementation of BFD associates Echo packets in UDP packets using port 3785 and the IP address of the transmitting interface. The contents of the Echo packet is defined as follows:

Field	Description
Version	The version number of the BFD protocol.
My Discriminator	An identifier for the BFD session connecting to the local side.
Sequence Number	The sequence number for this packet. This value is incremented for each successive packet transmitted for a session.

BFD Session Establishment

There are three states through which a BFD session normally proceeds: two for establishing a session (Up and Init state) and one for tearing down a session (Down state). In addition, an AdminDown state exists to administratively take down a session.

BFD uses a three-way handshake to establish sessions and guarantee that each BFD peer is aware of all the state changes. The transmitting system fills the state field in the transmitted BFD control packet with its current session state. To establish a session, the receiving peer system changes its session state based on the state field value in the received BFD control packet and its own session status.

A Down state means that a session is down or has been recently created. A session remains down until the remote system sends a packet with any state other than an up state. If a BFD packet with the state field set to down is received by the local system that is also in a down state, the session advances to Init state; if that packet signals Init state, the session advances to Up state.

Init signals that there is communication between the systems and that the local system wishes to start a session but the remote system has not yet acknowledged it. The session stays at Init until the local system receives a control packet with Init or Up in its state field (in which case the session state moves to Up) or until the detection time limit is reached.(in which case the remote system is then considered unreachable and the state moves to Down)

An Up state indicates that a BFD session has been created and both BFD peers are communicating with each other. The BFD session continues to remain in this state until connectivity fails and the state moves to Down or until the BFD session is taken down administratively.

Demultiplexing

Each BFD session must be able to uniquely identify itself and received BFD packets among the myriad of BFD sessions that are running. Each BFD peer must choose an identifying and unique discriminator value. This value is sent in the “My Discriminator” field of the BFD control packet, and is reflected back in the “Your Discriminator” field of the control packet sent from the remote peer. Once the system has echoed the respective “Your Discriminator” value back to its peer, the packets are demultiplexed (converted back into their original separate signals).

BFD Timer Negotiation

The BFD control packet contains information about how quickly a system would like to send packets to its peer, as well as how rapidly it is willing to receive packets from the peer. The BFD detection time is not carried explicitly in the protocol, but rather, it is determined by the receiving system independently based on the transmission interval (TX) and Detection Time Multiplier that have been negotiated.

The Detection Time Multiplier field value is approximately the number of packets that must be missed in order to declare a session down. In Asynchronous mode, detection times can be different in each direction. The local system detection time in this mode equals the value of Detection Time Multiplier received from the remote system multiplied by the negotiated transmission interval (TX). Because the time values for BFD control packet transmissions and session detection are being constantly negotiated by the participating BFD peers, they can be changed at any time. They are also independent in each direction for each session.

To change the rate at which BFD control packets are received, you can change the Required Min RX Interval at any time to any value. This new value is sent in the next outgoing packet so that the remote system can accommodate the changes made. Similarly, to change the rate at which BFD control packets are transmitted, you can change the Desired Min TX Interval at any time to any value.

With some exceptions, a system cannot transmit control packets with an interval shorter than the larger value of the TX interval and RX interval fields. This means that the system with the slower rate determines the BFD control packet transmission speed.

Configuring BFD

Configuring BFD for your network requires the following approach:

- 1** *Optional*: Configure a BFD session and related session parameter values. Once configured, enable all participating BFD sessions *before* configuring BFD interoperability with the supported Layer 3 protocols. See [“Configuring BFD Session Parameters” on page 21-12](#) for more information.
- 2** Configure BFD support for the Layer 3 protocols for which BFD establishes sessions. This implementation of BFD supports the IPv4 versions of BGP, OSPF, VRRP remote tracking, and static routes. See [“Configuring BFD Support for Layer 3 Protocols” on page 21-15](#) for more information.

At the end of the chapter is a simple BFD network diagram with instructions on how it can be created on a router-by-router basis. See [“BFD Application Example” on page 21-24](#) for more information.

Configuring BFD Session Parameters

When a BFD session is created, default values are automatically set for these parameters. However, it is possible to change these parameter values globally or for a specific BFD session. The following BFD session parameter values are used to create, monitor, and negotiate BFD sessions between peers.

- BFD session status (see [“Configuring a BFD Session” on page 21-12](#)).
- Transmit time interval (see [“Configuring the BFD Transmit Time interval” on page 21-13](#)).
- Receive time interval (see [“Configuring the BFD Receive Time Interval” on page 21-13](#)).
- Multiplier (see [“Configuring the BFD Multiplier” on page 21-14](#)).
- Echo interval (see [“Configuring the BFD Echo Interval” on page 21-13](#)).

Note. Once the default state of the BFD session is changed and the session is enabled, parameter values are no longer configurable. To subsequently change parameter values, disable the BFD session. See [“Enabling or Disabling BFD Status” on page 21-14](#) for more information.

Configuring a BFD Session

To configure a BFD session, use the **ip bfd interface** command and specify an existing IP interface name. For example:

```
-> ip bfd interface bfd-vlan-101
```

The above command configures BFD with the name `bfd-vlan-101`. See [“Enabling or Disabling BFD Status” on page 21-14](#) for more information.

To delete the BFD session, use the **no** form of the above command. For example:

```
-> no ip bfd interface bfd-vlan-101
```

The above command deletes the BFD session on `bfd-vlan-101`.

Note. The BFD interface session must be associated to an existing IP interface that is configured with an IP address.

Configuring the BFD Transmit Time Interval

Transmit Time Interval is the minimum amount of time that BFD waits between each successive transmission of control packets. BFD allows you to change the default value and set the transmit time interval from the valid range.

To change the global transmit time interval for BFD control packets, use the **ip bfd transmit** command. For example:

```
-> ip bfd transmit 500
```

The above command changes the global transmit time interval to 500 msec.

To change the transmit time interval for a specific BFD interface session, use the **ip bfd interface transmit** command along with the name and transmit time interval in milliseconds. For example:

```
-> ip bfd interface bfd-vlan-101 transmit 500
```

The above command changes the transmit time interval value to 500 msec on `bfd-vlan-101`.

The global transmit time interval serves as the default interval value for transmitting BFD control packets. This default value is overridden when a specific **transmit** value is configured.

Configuring the BFD Receive Time Interval

Receive Time Interval is the minimum amount of time that BFD waits to receive control packets before determining if there is a problem. BFD allows you to change the default value and set the receive time interval from the valid range.

To change the global receive time interval for BFD control packets, use the **ip bfd receive** command. For example:

```
-> ip bfd receive 500
```

The above command configures the global receive time interval of 500 msec.

To change the receive time interval for BFD control packets, use the **ip bfd interface receive** command. For example:

```
-> ip bfd interface bfd-vlan-101 receive 500
```

The above command changes the receive time interval value to 500 msec on `bfd-vlan-101`.

The global receive time interval serves as the default interval value for receiving BFD control packets. The default interval value is overridden when a specific **receive** value is configured.

Configuring the BFD Echo Interval

The time interval between received BFD echo packets is configurable and applies when the echo function is enabled. When this function is active, a stream of Echo packets is sent to a peer, which then loops these back to the sender without processing them through its forwarding path. If the sender does not receive several continuous echo packets from its peer, the BFD session is declared down.

To change the default value of the global BFD echo packet time interval, use the **ip bfd echo-interval** command. For example:

```
-> ip bfd echo-interval 500
```

The above command sets the echo interval to 500 milliseconds globally on all BFD sessions.

To change the BFD echo time interval for a particular BFD session, use the **ip bfd interface echo-interval** command. For example:

```
-> ip bfd interface bfd-vlan-101 echo-interval 500
```

The above command configures the echo time interval value to 500 milliseconds on `bfd-vlan-101`.

The global echo packet time interval serves as the default interval value. The default interval value is overridden when a specific value is configured.

Configuring the BFD Multiplier

The BFD multiplier value is used to calculate the BFD detection time in asynchronous mode. The detection time between neighbors is calculated by multiplying the negotiated transmit time interval by the dead interval multiplier. When an interface stops receiving packets from a neighbor, the interface uses the detection time value to determine how long to wait before declaring that the BFD session is down.

The BFD multiplier parameter can be configured globally for all BFD configured interfaces as well as for a specific interface.

To set or change the default global detection time multiplier value for all BFD sessions, use the **ip bfd multiplier** command. For example:

```
-> ip bfd multiplier 5
```

The above command assigns a multiplier value of 5 to all BFD sessions.

To change the BFD multiplier for a specific session, use the **ip bfd interface multiplier** command. For example:

```
-> ip bfd interface bfd-vlan-101 multiplier 5
```

The above command assigns a multiplier value of 5 to `bfd-vlan-101`.

Enabling or Disabling BFD Status

As BFD is globally disabled for the routing instance, to enable the global BFD status, use the **ip bfd admin-state** command. For example:

```
-> ip bfd admin-state enable
```

To disable the global BFD status for the routing instance, use the **ip bfd admin-state** command with the **disable** keyword. For example:

```
-> ip bfd admin-state disable
```

The above command disables BFD globally on the routing instance. Note that disabling BFD does not remove the existing BFD configuration from the routing instance. Also, when BFD is globally disabled, all BFD functionality is disabled for the routing instance, but configuring BFD is still allowed.

To enable a BFD session, use the **ip bfd interface admin-state** command. For example:

```
-> ip bfd interface bfd-vlan-101 admin-state enable
```

The above command enables the administrative status of `bfd-vlan-101`.

Note that a BFD session must be disabled before any of its parameters can be changed. To disable a BFD session, use the **ip bfd interface status** command with the **disable** keyword. For example:

```
-> ip bfd interface bfd-vlan-101 admin-state disable
```

To verify the BFD status and configuration for the switch, use the **show ip bfd** command,. For example:

```
-> show ip bfd
BFD Version Number           = 1,
Admin Status                  = Enabled,
Desired Transmit Interval    = 300,
Minimum Receive Interval     = 300,
Detection Time Multiplier    = 3,
Minimum Echo Receive Interval = 300,
Applications Registered      = STATIC-ROUTING OSPF PIM DVMRP
```

The above command shows that BFD is registered with the OSPF protocol and has a transmit interval of 300 msec, receive interval of 300 msec, multiplier 3, and echo interval of 300 msec.

To verify the BFD status and configuration, use the **show ip bfd interfaces** command. For example:

```
-> show ip bfd interfaces

Interface  Admin    Tx      Min Rx   Min EchoRx Detect   OperStatus
Name       Status   Interval Interval Interval Multiplier
-----+-----+-----+-----+-----+-----+-----
one        enabled  300     300     300     3         UP
two        enabled  300     300     300     3         UP
```

The output above displays the interfaces participating in the BFD sessions, along with their IP interface names and respective BFD session parameters. To see additional detail for a specific interface, use the **show ip bfd interfaces** command and specify an interface name. For example:

```
-> show ip bfd interfaces one
Interface Name           = one,
Interface IP Address     = 100.1.1.1,
Admin Status             = Enabled,
Desired Transmit Interval = 300,
Minimum Receive Interval = 300,
Detection Time Multiplier = 3,
Minimum Echo Receive Interval = 300,
Authentication Present   = No,
Oper Status              = UP
```

Configuring BFD Support for Layer 3 Protocols

After a BFD session is configured on all interfaces or on a specific set of individual interfaces, the next step is to configure BFD interoperability with the supported Layer 3 protocols (BGP, OSPF, VRRP Tracking, Static Routes). BFD interoperability with Layer 3 protocols is configurable at the router level to enable BFD session globally, or at the interface level for specific interfaces only.

The following sections provide information about how to configure BFD support for BGP, OSPF, VRRP Tracking, and Static Routes:

[“Configuring BFD Support for OSPF” on page 21-16.](#)

[“Configuring BFD Support for BGP” on page 21-18.](#)

[“Configuring BFD Support for VRRP Tracking” on page 21-20.](#)

[“Configuring BFD Support for Static Routes” on page 21-22.](#)

Configuring BFD Support for OSPF

The steps below show how to configure and verify BFD support for OSPF, so that OSPF is a registered protocol with BFD and receives forwarding path detection failure messages from BFD.

Note. OSPF must be running on all participating routers, and BFD must be configured and enabled on the participating OSPF interfaces. See “[Configuring BFD Session Parameters](#)” on page 21-12 for more information.

1 To associate BFD with the OSPF protocol and to change the default BFD status for the OSPF protocol, register OSPF with BFD at the protocol level using the **ip ospf bfd-state** command. For example:

```
-> ip ospf bfd-state enable
```

The BFD status for the OSPF protocol is now enabled, which means that communication between OSPF and BFD is enabled. To de-register OSPF with BFD, enter the following command:

```
-> ip ospf bfd-state disable
```

2 To verify the BFD status for OSPF protocol, use the **show ip ospf** command. For example:

```
->show ip ospf

Router Id                = 10.172.18.16,
OSPF Version Number     = 2,
Admin Status            = Enabled,
Area Border Router ?   = No,
AS Border Router Status = Disabled,
Route Tag               = 0,
SPF Hold Time (in seconds) = 10,
SPF Delay Time (in seconds) = 5,
MTU Checking           = Disabled,
# of Routes            = 9,
# of AS-External LSAs  = 0,
# of self-originated LSAs = 1,
# of LSAs received     = 0,
External LSDB Limit    = -1,
Exit Overflow Interval = 0,
# of SPF calculations done = 4,
# of Incr SPF calculations done = 0,
# of Init State Nbrs   = 0,
# of 2-Way State Nbrs  = 0,
# of Exchange State Nbrs = 0,
# of Full State Nbrs   = 0,
# of attached areas    = 1,
# of Active areas      = 1,
# of Transit areas     = 0,
# of attached NSSAs    = 0,
Default Route Origination = none,
Default Route Metric-Type/Metric = type2 / 1
BFD Status              = Disabled
```

3 Once OSPF is registered with BFD at the protocol level, enable the OSPF interface(s) that participate in BFD using the **ip ospf interface bfd-state** command. For example:

```
-> ip ospf interface vlan-10 bfd-state enable
```

The above command enables BFD on the interface named vlan-10. To enable BFD on all configured OSPF interfaces, use the **ip ospf bfd-state all-interfaces** command. For example:

```
-> ip ospf bfd-state all-interfaces enable
```

To disable BFD for all configured OSPF interfaces, use the **ip ospf bfd-state all-interfaces** command with the **disable** keyword. For example:

```
-> ip ospf bfd-state all-interfaces disable
```

4 To display the BFD status on an OSPF interface, use the **show ip ospf interface** command. For example:

```
-> show ip ospf interface
```

Interface Name	DR Address	Backup Address	DR Status	Admin Status	Oper State	BFD Status
vlan-10	213.10.10.1	213.10.10.254	enabled	up	DR	enabled
vlan-20	215.10.10.254	215.10.10.1	enabled	up	BDR	disabled

5 Once OSPF is registered with BFD at the protocol level and BFD is enabled on the desired OSPF interface(s), use the **show ip bfd interfaces** command to display BFD-enabled interfaces. For example:

```
-> show ip bfd interfaces
```

Interface Name	Admin Status	Tx Interval	Min Rx Interval	Min EchoRx Interval	Detect Multiplier	OperStatus
one	enabled	300	300	300	3	UP
two	enabled	300	300	300	3	UP

6 To establish BFD sessions with neighbors that are in full state only, enter the **ip ospf interface bfd-state drs-only** command as shown below:

```
-> ip ospf interface int1 bfd-state drs-only
```

The above command establishes a BFD session on interface named int1 with OSPF DR neighbors in full state only.

7 To establish a BFD session on an interface with all neighbors which are greater than or equal to “2-way” state, use the **ip ospf interface bfd-state all-neighbors** command as shown below:

```
-> ip ospf interface int2 bfd-state all-neighbors enable
```

The above command establishes a BFD session on interface named int2 with all OSPF neighbors that are greater than or equal to “2-way” state.

When any neighbors are added to this interface, OSPF informs BFD about the newly added neighbor(s); BFD then establishes a session with them. Use the **show ip bfd sessions** command to view BFD sessions with all BFD neighbors as shown below:

```
-> show ip bfd sessions
```

```
Legends: Neg.      = Negotiated
         Discr     = Discriminator
         Intvl     = Interval (in milliseconds)
```

Local Discr	Interface Name	Neighbor Address	State	Remote Discr	Neg. Rx Intvl	Neg. Tx Intvl	EchoRx Intvl
1	v1001	101.1.1.11	UP	1	300	300	300
2	v2000	200.1.1.1	UP	0	0	0	300

To view a BFD session with a particular neighbor, use the [show ip bfd sessions](#) command followed by the session number. For example:

```
-> show ip bfd sessions 1
```

```
Local discriminator      = 1,
Neighbor IP Address     = 101.1.1.11,
Requested Session Type  = ASYNC ,
Interface IfIndex       = 2,
Source UDP Port         = 49153,
State                   = UP,
Session Operating Mode  = None,
Remote discriminator    = 1,
Negotiated Tx interval  = 300,
Negotiated Rx interval  = 300,
Echo Rx interval        = 300,
Multiplier              = 3,
Applications Registered: = OSPF PIM
```

Whenever there is any change to the interface/neighbor list or interface/neighbor state, OSPF immediately informs BFD about the changes. Additionally, whenever BFD detects any changes to the other end, BFD updates its database accordingly and informs OSPF for its fastest convergence.

Configuring BFD Support for BGP

The steps below show how to configure and verify BFD support for the BGP protocol, so that BGP is a registered protocol with BFD and receives forwarding path detection failure messages from BFD.

Note. BFD must be configured and enabled on the participating BGP interfaces. See [“Configuring BFD Session Parameters”](#) on page 21-12 for more information.

1 To associate BGP protocol with BFD liveness detection, register BGP with BFD at the protocol level using the [ip bgp bfd-state](#) command as shown below:

```
-> ip bgp bfd-state enable
```

The BFD status for the BGP protocol is now enabled, which means that communication between BGP and BFD is enabled. To de-register BGP with BFD, enter the following command:

```
-> ip bgp bfd-state disable
```

To verify the BFD status for BGP protocol, you can use the [show ip bgp](#) command as shown below:

```
-> show ip bgp
```

```
Admin Status           = disabled,
Operational Status    = down,
Autonomous System Number = 1,
BGP Router Id         = 0.0.0.0,
Confederation Identifier = 0,
IGP Synchronization Status = disabled,
Minimum AS Origin Interval (seconds) = 15,
Default Local Preference = 100,
Route Reflection      = disabled,
Cluster Id           = 0.0.0.0,
Missing MED Status    = Best,
Aspath Comparison     = enabled,
Always Compare MED    = disabled,
Fast External FailOver = disabled,
Log Neighbor Changes  = disabled,
Multiple Paths        = disabled,
Graceful Restart      = enabled,
Graceful Restart Status = Not Restarting,
Configured Graceful Restart Interval = 90s,
IPv4 Unicast          = enabled,
IPv6 Unicast          = disabled,
BFD Status            = disabled
```

2 Once BGP is registered with BFD at the protocol level, you need to enable BFD for particular BGP neighbors using the **ip bgp neighbor bfd-state** command as shown below:

```
-> ip bgp neighbor 135.10.10.2 bfd-state enable
```

The above command enables BFD for neighbor with IP address 135.10.10.2. To enable BFD for all BGP neighbors, use the **ip bgp bfd-state all-neighbors** command as shown below:

```
-> ip bgp bfd-state all-neighbors enable
```

To disable BFD for all configured BGP neighbors, use the **ip bgp bfd-state all-neighbors** with the **disable** keyword, as shown below:

```
-> ip bgp bfd-state all-neighbors disable
```

To display the BFD status of BGP neighbors, use the **show ip bgp neighbors** command. For example:

```
-> show ip bgp neighbors
```

```
Legends: Nbr = Neighbor
         As  = Autonomous System
```

Nbr	address	As	Admin state	Oper state	BGP Id	Up/Down	BFD Status
100.1.1.10		2	enabled	established	3.3.3.3	00h:02m:19s	enabled

Use the **show ip bfd sessions** command to view BFD sessions with all BFD neighbors. For example:

```
-> show ip bfd sessions
```

```
Legends: Neg.      = Negotiated
         Discr     = Discriminator
         Intvl     = Interval (in milliseconds)
```

Local Discr	Interface Name	Neighbor Address	State	Remote Discr	Neg. Rx Intvl	Neg. Tx Intvl	EchoRx Intvl
1	v1001	101.1.1.11	UP	1	300	300	300
2	v2000	200.1.1.1	UP	0	0	0	300

```
-> show ip bfd sessions 1
```

```
Local discriminator           = 1,
Neighbor IP Address          = 100.1.1.10,
Requested Session Type       = ASYNC ,
Interface IfIndex            = 2,
Source UDP Port               = 49152,
State                         = UP,
Session Operating Mode       = None,
Remote discriminator         = 1,
Negotiated Tx interval       = 300,
Negotiated Rx interval       = 300,
Echo Rx interval             = 300,
Multiplier                   = 3,
Applications Registered:     = BGP PIM
```

Configuring BFD Support for VRRP Tracking

The steps below show you how to configure and verify BFD support for VRRP protocol, so that VRRP is a registered protocol with BFD and receives forwarding path detection failure messages from BFD.

1 To associate VRRP protocol with BFD liveliness detection, register VRRP with BFD at the protocol level using the **vrrp bfd-state** command as shown below:

```
-> vrrp bfd-state enable
```

Note. VRRP protocol supports BFD in the echo-only operational mode.

BFD status for VRRP protocol is now enabled which means that socket communication between VRRP and BFD is enabled. To de-register VRRP with BFD, enter the following command at the system prompt:

```
-> vrrp bfd-state disable
```

To verify the BFD status for VRRP protocol, you can use the **show vrrp** command as shown below:

```
-> show vrrp

VRRP default advertisement interval: 1 second
VRRP default priority: 100
VRRP default preempt: Yes
VRRP trap generation: Enabled
VRRP startup delay: 45 (expired)

VRRP BFD-STATUS : Enabled
```

VRID	VLAN	IP Address(es)	Admin Status	Priority	Preempt	Adv. Interval
1	1	192.168.170.1 192.168.170.2	Enabled	255	Yes	1
2	15	10.2.25.254	Disabled	100	No	1

2 Once VRRP is registered with BFD at the protocol level, enable BFD for a particular VRRP track policy using the `vrrp track address bfd-state` command. Ensure that the track policy is associated with at least one of the virtual routers. For example:

```
-> vrrp track 2 address 10.1.1.1 bfd-state enable
```

The above command enables BFD for a track policy with VRRP track number 2 and a remote interface address of 10.1.1.1.

Note. The value of the address parameter must be a remote interface address. BFD cannot be configured for a local interface address.

Use the `show vrrp track` command to verify whether BFD is enabled for a particular track policy. For example:

```
-> show vrrp track
```

Track ID	Policy	Admin State	Oper State	Pri	BFD Status
1	190.1.1.10	Enabled	Down	100	Disabled
2	10.1.1.1	Enabled	Up	25	Enabled

Use the `show ip bfd interfaces` command to verify the BFD interface/session configuration and operation status.

Once the track policy is configured, the BFD session is established with the remote IP address. BFD session is also established with the BFD neighbors.

Use the **show ip bfd sessions** command to view BFD sessions with all BFD neighbors. For example:

```
-> show ip bfd sessions
```

```
Legends: Neg.      = Negotiated
         Discr     = Discriminator
         Intvl    = Interval (in milliseconds)
```

Local Discr	Interface Name	Neighbor Address	State	Remote Discr	Neg. Rx Intvl	Neg. Tx Intvl	EchoRx Intvl
1	v1001	101.1.1.11	UP	1	300	300	300
2	v2000	200.1.1.1	UP	0	0	0	300

```
-> show ip bfd sessions 2
```

```
Local discriminator           = 2,
Neighbor IP Address          = 10.1.1.1,
Requested Session Type       = ECHO,
Interface IfIndex            = 4,
Source UDP Port              = 49153,
State                        = UP,
Session Operating Mode       = None,
Remote discriminator         = 0,
Negotiated Tx interval      = 0,
Negotiated Rx interval      = 0,
Echo Rx interval            = 300,
Multiplier                   = 3,
Applications Registered:    = VRRP PIM
```

Configuring BFD Support for Static Routes

This section provides information about how to configure and verify BFD support for static routing.

To change the default BFD status for a particular static route and to enable BFD support, use the **ip static-route bfd-state** command. For example:

```
-> ip static-route 10.1.1.1 mask 255.0.0.0 gateway 10.1.1.25 bfd-state enable
```

Note. Static Routes support BFD in the echo-only operational mode.

The above command enables BFD support for a static route with destination ip address as 10.1.1.1, destination network mask as 255.0.0.0, and gateway address as 10.1.1.25.

In order to create a BFD session for a static route, the gateway address must not match with any local interface address of the switch. If multiple routes are configured with the same gateway address, only one BFD session is run. You can verify the BFD session list which shows the gateway address using the **show ip bfd sessions** command.

To enable BFD support for all static routes, use the **ip static-route all bfd-state** command:

```
-> ip static-route all bfd-state enable
```

To verify the static routes on which BFD is enabled, use the **show ip router database** command with the **protocol static** option. For example:

```
-> show ip router database protocol static
```

Legend: + indicates routes in-use

b indicates BFD-enabled static route

r indicates recursive static route, with following address in brackets

Total IPRM IPv4 routes: 7

Destination	Gateway	Interface	Protocol	Metric	Tag	Misc-Info
+b 100.0.0.0/8	100.1.1.10	v1001	STATIC	1	0	
+ 128.251.40.0/24	172.28.4.254	EMP	STATIC	1	0	

Inactive Static Routes

Destination	Gateway	Metric
-------------	---------	--------

BFD Application Example

This section provides an example network configuration in which BFD is associated with the OSPF protocol running on the network. In addition, a tutorial is also included that provides steps on how to configure the example network topology using the Command Line Interface (CLI).

Example Network Overview

The diagram below represents a simple OSPF network consisting of three routers. On all three routers, OSPF is associated with BFD for faster failure detection of any router on the network.

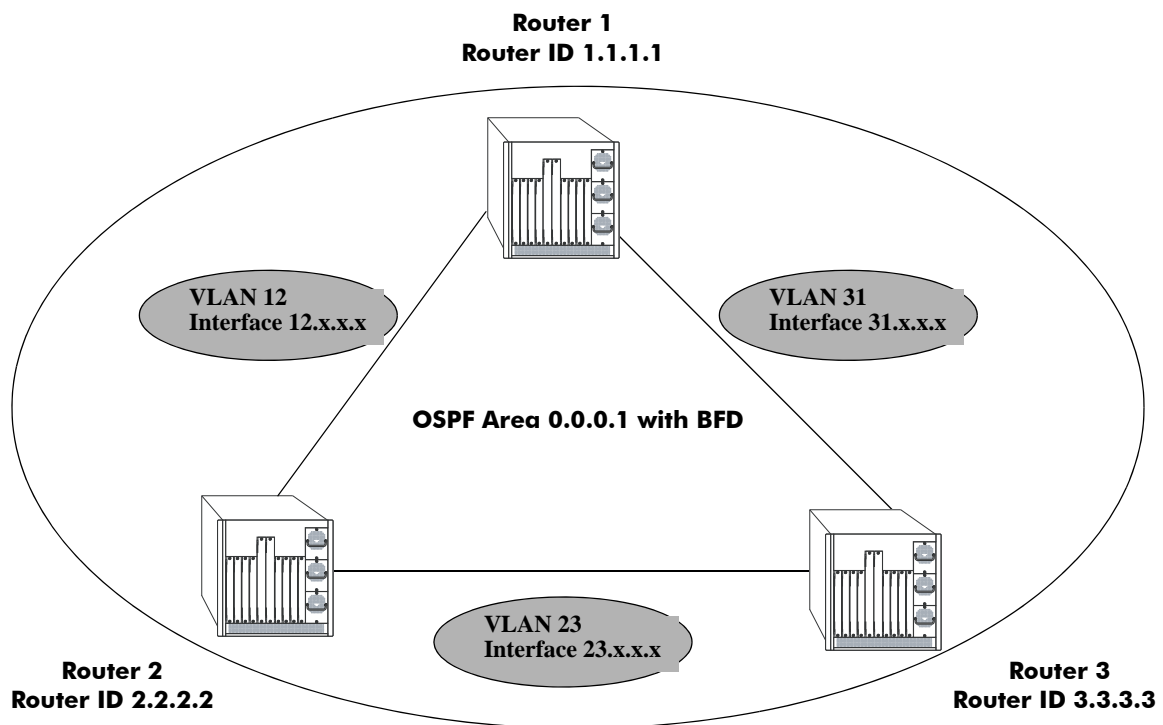

Example OSPF Network using the BFD Protocol

The following steps are used to configure the example BFD-enabled OSPF network as shown in the diagram above.

Note. Configuring a BFD session explicitly with an IP interface name on individual routers is optional, and must be used if user defined BFD session parameters need to be applied. All the steps for explicit configuration are mentioned as optional.

Step 1: Prepare the Routers

The first step is to create the VLANs on each router, add an IP interface to the VLAN, assign a port to the VLAN, and assign a router identification number to the routers. For the backbone connection, the network design in this case uses slot 2, port 1 as the egress port and slot 2, port 2 as ingress port on each router. Router 1 connects to Router 2, Router 2 connects to Router 3, and Router 3 connects to Router 1.

Note. The ports is statically assigned to the router VLANs, as a VLAN must have a physical port assigned to it in order for the IP router interface to function.

The commands to set up the VLAN configuration are shown below:

Router 1 (using ports 1/1/1 and 1/1/2 for the backbone and ports 1/1/3-5 for end devices):

```
-> vlan 31
-> ip interface vlan-31 vlan 31 address 31.0.0.1 mask 255.0.0.0
-> vlan 31 members port 1/1/1

-> vlan 12
-> ip interface vlan-12 vlan 12 address 12.0.0.1 mask 255.0.0.0
-> vlan 12 members port 1/1/2

-> vlan 10
-> ip interface vlan-10 vlan 10 address 10.0.0.1 mask 255.0.0.0
-> vlan 10 members port 1/1/3-5

-> ip router router-id 1.1.1.1
```

These commands created VLANs 31, 12, and 10.

- VLAN 31 handles the backbone connection from Router 1 to Router 3, using the IP router port 31.0.0.1 and physical port 1/1/1.
- VLAN 12 handles the backbone connection from Router 1 to Router 2, using the IP router port 12.0.0.1 and physical port 1/1/2.
- VLAN 10 handles the device connections to Router 1, using the IP router port 10.0.0.1 and physical ports 1/1/3-5. More ports could be added at a later time if necessary.

The router was assigned the Router ID of 1.1.1.1.

Router 2 (using ports 1/1/1 and 1/1/2 for the backbone and ports 1/1/3-5 for end devices):

```
-> vlan 12
-> ip interface vlan-12 vlan 12 address 12.0.0.2 mask 255.0.0.0
-> vlan 12 members port 1/1/1

-> vlan 23
-> ip interface vlan-23 vlan 23 address 23.0.0.2 mask 255.0.0.0
-> vlan 23 members port 1/1/2

-> vlan 20
-> ip interface vlan-20 vlan 20 address 20.0.0.2 mask 255.0.0.0
-> vlan 20 members port 1/1/3-5

-> ip router router-id 2.2.2.2
```

These commands created VLANs 12, 23, and 20.

- VLAN 12 handles the backbone connection from Router 1 to Router 2, using the IP router port 12.0.0.2 and physical port 1/1/1.
- VLAN 23 handles the backbone connection from Router 2 to Router 3, using the IP router port 23.0.0.2 and physical port 1/1/2.
- VLAN 20 handles the device connections to Router 2, using the IP router port 20.0.0.2 and physical ports 1/1/3-5. More ports could be added at a later time if necessary.

The router was assigned the Router ID of 2.2.2.2.

Router 3 (using ports 1/1/1 and 1/1/2 for the backbone, and ports 1/1/3-5 for end devices):

```
-> vlan 23
-> ip interface vlan-23 vlan 23 address 23.0.0.3 mask 255.0.0.0
-> vlan 23 members port 1/1/1

-> vlan 31
-> ip interface vlan-31 vlan 31 address 31.0.0.3 mask 255.0.0.0
-> vlan 31 members port 1/1/2

-> vlan 30
-> ip interface vlan-30 vlan 30 address 30.0.0.3 mask 255.0.0.0
-> vlan 30 members port 1/1/3-5

-> ip router router-id 3.3.3.3
```

These commands created VLANs 23, 31, and 30.

- VLAN 23 handles the backbone connection from Router 2 to Router 3, using the IP router port 23.0.0.3 and physical port 1/1/1.
- VLAN 31 handles the backbone connection from Router 3 to Router 1, using the IP router port 31.0.0.3 and physical port 1/1/2.
- VLAN 30 handles the device connections to Router 3, using the IP router port 30.0.0.3 and physical ports 1/1/3-5. More ports could be added at a later time if necessary.

The router was assigned the Router ID of 3.3.3.3.

Step 2: Enable OSPF

The next step is to load and enable OSPF on each router. The commands for this step are below (the commands are the same on each router):

```
-> ip load ospf
-> ip ospf admin-state enable
```

Step 3: Create the OSPF Area

Now the area must be created. In this case, we create area 0.0.0.1. The command for this step is below (the command is the same on each router):

```
-> ip ospf area 0.0.0.1
```

Area 0.0.0.1 is created and enabled.

Step 4: Configure OSPF Interfaces

Next, OSPF interfaces must be created, enabled, and assigned to area 0.0.0.1. The OSPF interfaces must have the same interface name as the IP router interfaces created above in [“Step 1: Prepare the Routers” on page 21-25](#).

Router 1

```
-> ip ospf interface vlan-31
-> ip ospf interface vlan-31 area 0.0.0.0
-> ip ospf interface vlan-31 admin-state enable

-> ip ospf interface vlan-12
-> ip ospf interface vlan-12 area 0.0.0.0
-> ip ospf interface vlan-12 admin-state enable

-> ip ospf interface vlan-10
-> ip ospf interface vlan-10 area 0.0.0.1
-> ip ospf interface vlan-10 admin-state enable
```

Router 2

```
-> ip ospf interface vlan-12
-> ip ospf interface vlan-12 area 0.0.0.0
-> ip ospf interface vlan-12 admin-state enable

-> ip ospf interface vlan-23
-> ip ospf interface vlan-23 area 0.0.0.0
-> ip ospf interface vlan-23 admin-state enable

-> ip ospf interface vlan-20
-> ip ospf interface vlan-20 area 0.0.0.2
-> ip ospf interface vlan-20 admin-state enable
```

Router 3

```
-> ip ospf interface vlan-23
-> ip ospf interface vlan-23 area 0.0.0.0
-> ip ospf interface vlan-23 admin-state enable

-> ip ospf interface vlan-31
-> ip ospf interface vlan-31 area 0.0.0.0
-> ip ospf interface vlan-31 admin-state enable

-> ip ospf interface vlan-30
-> ip ospf interface vlan-30 area 0.0.0.3
-> ip ospf interface vlan-30 admin-state enable
```

Step 5: (Optional) Configure BFD Interfaces

Next, BFD interfaces must be created and enabled. The BFD interfaces must have the same interface name as the IP router interfaces created above in [“Step 1: Prepare the Routers” on page 21-25](#).

Router 1

```
-> ip bfd interface vlan-31
-> ip bfd interface vlan-31 admin-state enable

-> ip bfd interface vlan-12
-> ip bfd interface vlan-12 admin-state enable
```

```
-> ip bfd interface vlan-10
-> ip bfd interface vlan-10 admin-state enable
```

Router 2

```
-> ip bfd interface vlan-12
-> ip bfd interface vlan-12 admin-state enable

-> ip bfd interface vlan-23
-> ip bfd interface vlan-23 admin-state enable

-> ip bfd interface vlan-20
-> ip bfd interface vlan-20 admin-state enable
```

Router 3

```
-> ip bfd interface vlan-23
-> ip bfd interface vlan-23 admin-state enable

-> ip bfd interface vlan-31
-> ip bfd interface vlan-31 admin-state enable

-> ip bfd interface vlan-30
-> ip bfd interface vlan-30 admin-state enable
```

Step 6: (Optional) Configure Global BFD Parameters

Global BFD parameter settings for timer values and operational mode are applied to all BFD interfaces configured on the routing instance. When a BFD interface is created, the global settings are also applied as the default parameter values for the interface.

The following steps change the default global BFD parameter values for the example network; the commands used are the same on each router.

- Set the minimum amount of time BFD waits between each transmission of control packets to 200.
-> ip bfd transmit 200 milliseconds
- Set the minimum amount of time BFD waits to receive control packets to 200 milliseconds.
-> ip bfd receive 200
- Set the global BFD Echo packet time interval to 200 milliseconds.
-> ip bfd echo-interval 200

Step 7: Enable BFD and register OSPF with BFD

Once all the global BFD parameters are configured, enable BFD on all interfaces, register BFD with OSPF, and then enable BFD on all OSPF interfaces. The following steps are the same on each router:

In this example, global BFD parameters will be used for the BFD sessions. Enable BFD admin status and register OSPF with BFD and then enable BFD on all OSPF interfaces. Repeat the following steps on each router:

```
-> ip bfd admin-state enable
-> ip ospf bfd-state enable
-> ip ospf bfd-state all-interfaces enable
```

Step 8: Examine the Network

After the network has been created, use the following **show** commands to check various aspects of the example network:

- To verify the configured BFD status on routers, use the **show ip bfd** command. This command shows the protocols registered for BFD (OSPF in example network) and the parameter values for the transmit, receive, and echo intervals, the multiplier number, and the operational mode.
- To display information about BFD sessions, use the **show ip bfd sessions** command.
- To check the BFD status at the OSPF protocol level, use the **show ip ospf** command. This command is also used to check the general OSPF configuration. For OSPF interfaces, use the **show ip ospf interface** command.

Verifying the BFD Configuration

To display information such as the BFD status for different session parameters and Layer 3 protocols, use the **show** commands listed in the following table:

show ip bfd	Displays the global BFD configuration for the routing instance.
show ip bfd interfaces	Displays the BFD interface configuration for the switch.
show ip bfd sessions	Displays the BFD neighbors and session states.
show ip ospf	Displays the BFD status for the OSPF protocol.
show ip ospf interface	Displays the BFD status for OSPF interfaces.
show ip bgp	Displays the BFD status for the BGP protocol.
show ip bgp neighbors	Displays the BFD status for BGP neighbors.
show vrrp	Displays the BFD status for the VRRP protocol.
show vrrp track	Displays the BFD status for a track policy.
show ip router database protocol static	Displays the BFD status for static routes.

For more information about the resulting displays from these commands, see the *OmniSwitch AOS Release 8 CLI Reference Guide*. Examples of the above commands and their outputs are given in the section “Configuring BFD” on page 21-12.

22 Configuring DHCP Relay

The User Datagram Protocol (UDP) is a connectionless transport protocol that runs on top of IP networks. The DHCP Relay allows you to use nonroutable protocols (such as UDP) in a routing environment. UDP is used for applications that do not require the establishment of a session and end-to-end error checking. Email and file transfer are two applications that could use UDP. UDP offers a direct way to send and receive datagrams over an IP network and is primarily used for broadcasting messages. This chapter describes the DHCP Relay feature. This feature allows UDP broadcast packets to be forwarded across VLANs that have IP routing enabled.

In This Chapter

This chapter describes the basic components of DHCP Relay and how to configure them. CLI commands are used in the configuration examples. For more details about the syntax of commands, see the *OmniSwitch AOS Release 8 CLI Reference Guide*.

Configuration procedures described in this chapter include:

- Quick steps for configuring DHCP Relay on [page 22-4](#).
- Setting the IP address for Global DHCP on [page 22-9](#).
- Identifying the VLAN for Per-VLAN DHCP on [page 22-9](#).
- Enabling DHCP Relay on [page 22-10](#).
- Setting the Forward Delay time on [page 22-10](#).
- Setting the Maximum Hops value on [page 22-11](#).
- Setting the Relay Forwarding Option to Standard and Per-VLAN on [page 22-11](#).
- Using automatic IP configuration to obtain an IP address for the switch on [page 22-12](#).
- Configuring relay for generic UDP service ports on [page 22-13](#).
- Using the Relay Agent Information Option (Option-82) on [page 22-16](#)
- Using DHCP Snooping on [page 22-19](#)

For information about the IP protocol, see [Chapter 16, “Configuring IP.”](#)

DHCP Relay Specifications

Platforms Supported	OmniSwitch 6860, 6860E
RFCs Supported	0951–Bootstrap Protocol 1534–Interoperation between DHCP and BOOTP 1541–Dynamic Host Configuration Protocol 1542–Clarifications and Extensions for the Bootstrap Protocol 2132–DHCP Options and BOOTP Vendor Extensions 3046–DHCP Relay Agent Information Option, 2001
DHCP Relay Implementation	Global DHCP Per-VLAN DHCP
DHCP Relay Service	BOOTP/DHCP (Bootstrap Protocol/Dynamic Host Configuration Protocol)
UDP Port Numbers	67 for Request 68 for Response
IP addresses supported for each Relay Service	Maximum of 256 IP addresses for each Relay Service.
IP addresses supported for the Per-VLAN service	Maximum of 256 VLAN relay services.
Maximum number of UDP relay services allowed per switch	10
Maximum number of VLANs to which forwarded UDP service port traffic is allowed	256

DHCP Relay Defaults

The following table describes the default values of the DHCP Relay parameters:

Parameter Description	Command	Default Value/Comments
Default UDP service	ip udp relay service	BOOTP/DHCP
Forward delay time value for DHCP Relay	ip helper forward-delay	3 seconds
Maximum number of hops	ip helper maximum-hops	4 hops
Packet forwarding option	ip helper standard ip helper per-vlan-only	Standard
Automatic switch IP configuration for default VLAN 1	ip helper boot-up	Disabled
Automatic switch IP configuration packet type (BootP or DHCP)	ip helper boot-up enable	BootP
Relay Agent Information Option	ip helper agent-information	Disabled

Quick Steps for Setting Up DHCP Relay

You must configure DHCP Relay on switches where packets are routed between IP networks.

There is no separate command for enabling or disabling the relay service. DHCP Relay is automatically enabled on the switch whenever a DHCP server IP address is defined. To set up DHCP Relay, proceed as follows:

1 Identify the IP address of the DHCP server. Where the DHCP server has IP address 128.100.16.1, use the following command:

```
-> ip helper address 128.100.16.1
```

2 Set the forward delay timer for the DHCP relay. To set the timer for a 15 second delay, use the following command:

```
-> ip helper forward-delay 15
```

3 Set the maximum hop count value. To set a hop count of 3, use the following command:

```
-> ip helper maximum-hops 3
```

Note. Optional. To verify the DHCP Relay configuration, enter the [show ip helper](#) command. The display shown for the DHCP Relay configured in the above Quick Steps is shown here:

```
-> show ip helper
```

```
Ip helper :
Forward Delay (seconds) = 15,
Max number of hops      = 3,
Relay Agent Information = Disabled,
PXE support              = Disabled,
Forward option           = standard mode,
Bootup Option           = Disable
Forwarding address list (Standard mode): 128.100.16.1
```

Note. For more information about this display, see the “DHCP Relay” chapter in the *OmniSwitch AOS Release 8 CLI Reference Guide*.

DHCP Relay Overview

The DHCP Relay service, its corresponding port numbers, and configurable options are as follows:

- DHCP Relay Service: BOOTP/DHCP
- UDP Port Numbers 67/68 for Request/Response
- Configurable options: DHCP server IP address, Forward Delay, Maximum Hops, Forwarding Option, automatic switch IP configuration

The port numbers indicate the destination port numbers in the UDP header. The DHCP Relay verifies whether the forward delay time (specified by the user) has elapsed before sending the packet down to UDP with the destination IP address replaced by the address (also specified by the user).

If the relay is configured with multiple IP addresses, then the packet is sent to all IP address destinations. The DHCP Relay also verifies that the maximum hop count has not been exceeded. If the forward delay time is *not* met or the maximum hop count is exceeded, the BOOTP/DHCP packet is discarded by the DHCP Relay.

The forwarding option allows you to specify if the relay must operate in the standard and per-VLAN-only mode. The standard mode forwards all DHCP packets on a global relay service. The per-VLAN-only mode forwards DHCP packets that originate from a specific VLAN. See [“Setting the Relay Forwarding Option” on page 22-11](#) for more information.

DHCP Relay service enables automatic IP address configuration for default VLAN 1 when a switch that is not configured boots up. If this function is enabled, the switch broadcasts a BootP or a DHCP request packet at boot time. When the switch receives an IP address from a BootP/DHCP server, the address is assigned to default VLAN 1. See [“Enabling Automatic IP Configuration” on page 22-12](#) for more information.

Alternately, the relay function can be provided by an external router connected to the switch; in this case, the relay is configured on the external router.

DHCP

DHCP (Dynamic Host Configuration Protocol) provides a framework for passing configuration information to Internet hosts on a TCP/IP network. It is based on the Bootstrap Protocol (BOOTP), adding the ability to automatically allocate reusable network addresses and additional configuration options. DHCP consists of the following two components:

- A protocol for delivering host-specific configuration parameters from a DHCP server to a host.
- A mechanism for allocating network addresses to hosts.

DHCP is built on a client-server model in which a designated DHCP server allocates network addresses and delivers configuration parameters to dynamically configured hosts. It supports the following three mechanisms for IP address allocation.

Automatic—DHCP assigns a permanent IP address to a host.

Dynamic—DHCP assigns an IP address to a host for a limited period of time (or until the host explicitly relinquishes the address).

Manual—The network administrator assigns a host IP address and DHCP simply conveys the assigned address to the host.

DHCP and the OmniSwitch

The unique characteristics of the DHCP protocol require a good plan before setting up the switch in a DHCP environment. Since DHCP clients initially have no IP address, placement of these clients in a VLAN is hard to determine.

The DHCP feature on OmniSwitch provides two services to the network users:

- DHCP Relay Agent
- Generic UDP Relay

The DHCP Relay Agent provides the network interfaces dynamic IP addresses from the DHCP server present on a different VLAN. This feature can be configured using the **ip helper** and related commands.

The Generic UDP Relay forwards the broadcast packets with pre-configured destination UDP port information to destination VLAN or VLANs. This feature can be configured using the **ip udp relay** and related commands.

For more information on the CLI commands related to DHCP Relay, see the “DHCP Relay Commands” chapter in the *OmniSwitch AOS Release 8 CLI Reference Guide*.

External DHCP Relay Application

The DHCP Relay can be configured on a router that is external to the switch. In this application example the switched network has a single VLAN configured with multiple segments. All of the network hosts are DHCP-ready, meaning they obtain their network address from the DHCP server. The DHCP server resides behind an external network router that supports the DHCP Relay functionality.

The router must support DHCP Relay functionality to be able to forward DHCP frames. In this example, DHCP Relay is supported within an external router that forwards request frames from the incoming router port to the outgoing router port attached to the OmniSwitch.

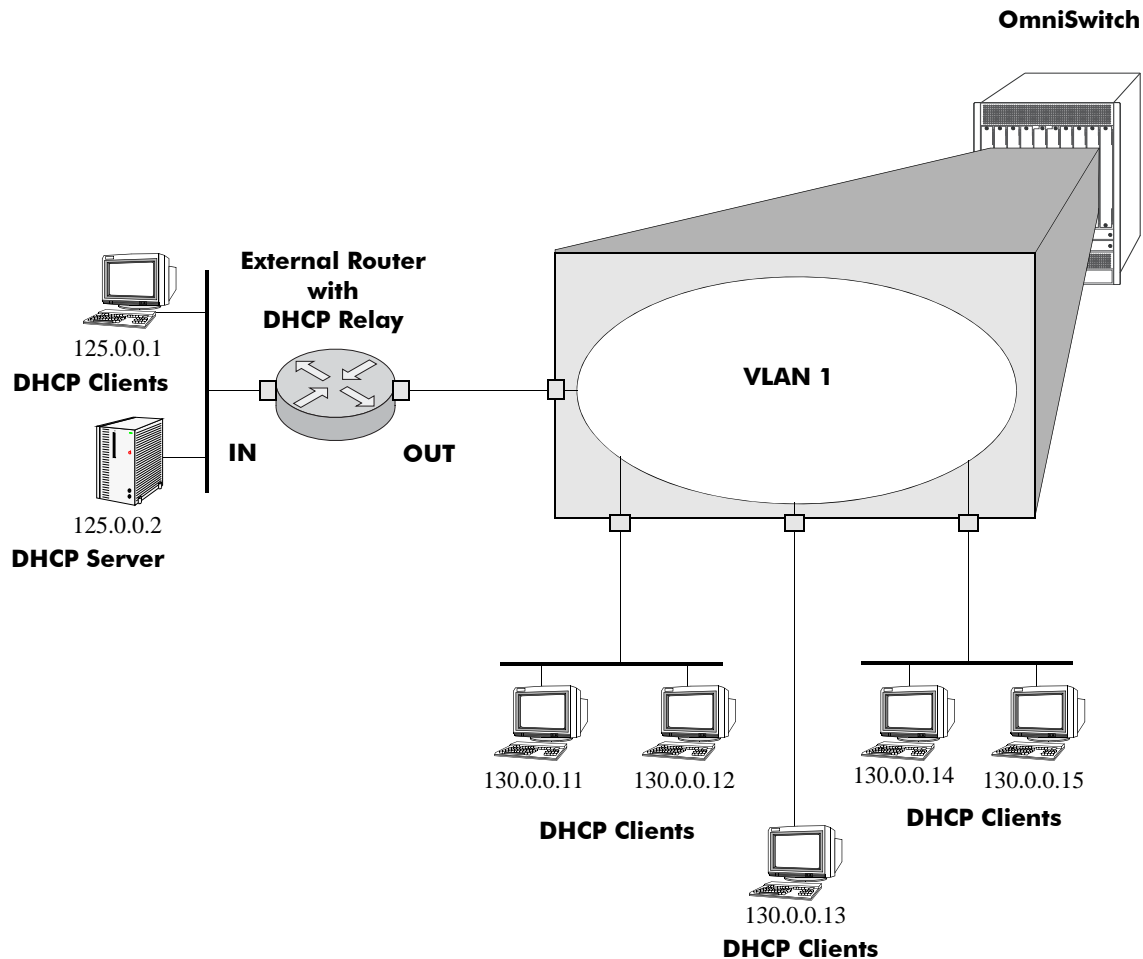

DHCP Clients are Members of the Same VLAN

The external router inserts the subnet address of the first hop segment into the DHCP request frames from the DHCP clients. This subnet address allows the DHCP server to locate the segment on which the requesting client resides. In this example, all clients attached to the OmniSwitch are DHCP-ready and have the same subnet address (130.0.0.0) inserted into each of the requests by the DHCP Relay function of the router. The DHCP server assigns a different IP address to each of the clients. The switch does not need an IP address assigned to it. All DHCP clients are members of either a default VLAN or an IP protocol VLAN.

Internal DHCP Relay

The internal DHCP Relay is configured using the UDP forwarding feature in the switch, available through the **ip helper address** command. For more information, see “[DHCP Relay Implementation](#)” on page 22-9.

This application example shows a network with two VLANs, each with multiple segments. All network clients are DHCP-ready and the DHCP server resides on just one of the VLANs. This example is much like the first application example, except that the DHCP Relay function is configured inside the switch.

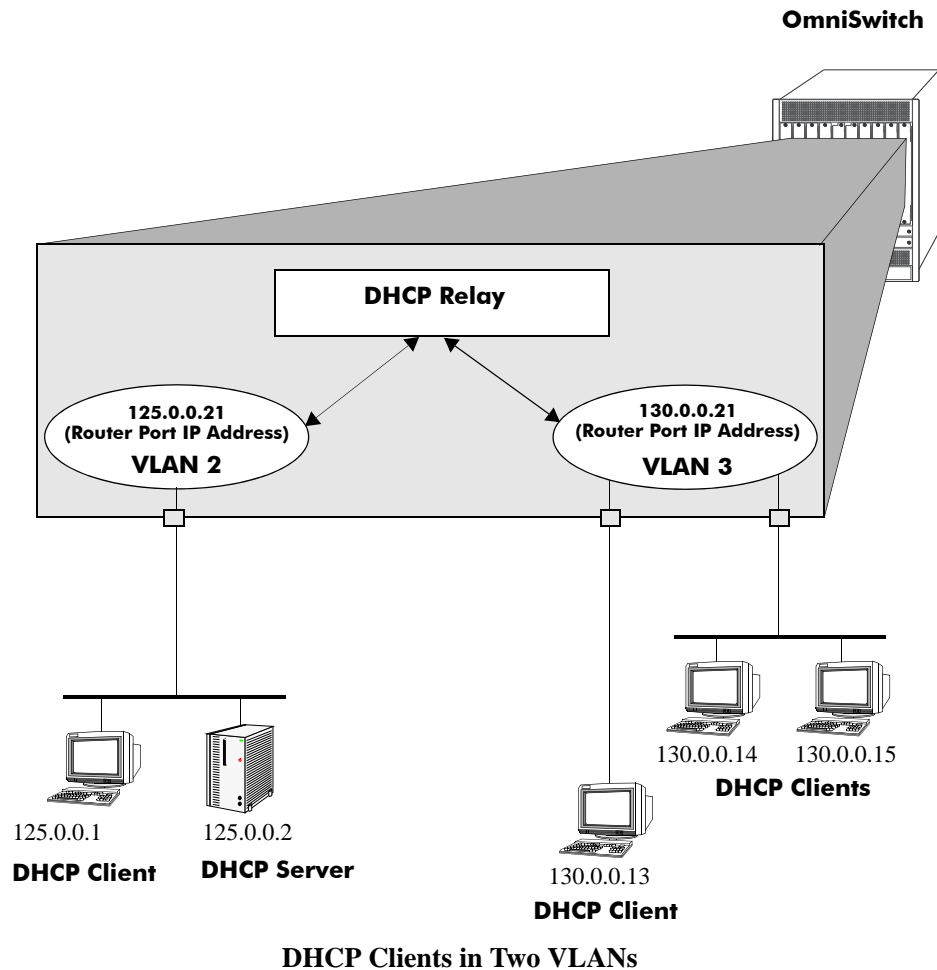

During initialization, each network client forwards a DHCP request frame to the DHCP server using the local broadcast address. For these locally attached stations, the frame is simply switched from one station to another.

In this case, the DHCP server and clients must be members of the same VLAN (they can also be members of the default VLAN).

Since the clients in the application example are not members of the same VLAN as the DHCP server, they must request an IP address through the DHCP Relay routing entity in the switch. When a DHCP request frame is received by the DHCP Relay entity, it is forwarded from VLAN 3 to VLAN 2. All the DHCP-ready clients in VLAN 3 must be members of the same VLAN, and the switch must have the DHCP Relay function configured.

DHCP Relay Implementation

The OmniSwitch allows you to configure the DHCP Relay feature in one of two ways. You can set up a global DHCP Relay or you can set up the DHCP Relay based on the DHCP packet from the client. Both of these choices provide the same configuration options and capabilities. However, they are mutually exclusive. The following matrix summarizes the options.

Per-VLAN DHCP Relay	Global DHCP Relay	Effect
Disabled	Disabled	DHCP Request is flooded within its VLAN
Disabled	Enabled	DHCP Request is relayed to the Global Relay
Enabled	Disabled	DHCP Request is relayed to the Per-VLAN Relay
Enabled	Enabled	N/A

Global DHCP

For the global DHCP service, you must identify an IP address for the DHCP server.

Setting the IP Address

The DHCP Relay is enabled on a switch whenever a DHCP server IP address is defined by using the **ip helper address** command. There is no separate command for enabling or disabling the relay service. You must configure DHCP Relay on switches where packets are routed between IP networks. The following command defines a DHCP server address:

```
-> ip helper address 125.255.17.11
```

The DHCP Relay forwards BOOTP/DHCP broadcasts to and from the specified address. If multiple DHCP servers are used, one IP address must be configured for each server.

To delete an IP address, use the **no** form of the **ip helper address** command. The IP address specified with this syntax is deleted. If an IP address is not specified with this syntax, then *all* IP helper addresses are deleted. The following command deletes an IP helper address:

```
-> no ip helper address 125.255.17.11
```

Per-VLAN DHCP

For the Per-VLAN DHCP service, you must identify the number of the VLAN that makes the relay request.

Identifying the VLAN

You can enter one or more server IP addresses to which packets are sent from a specified VLAN. Do this by using the **ip helper vlan address** command. The following syntax identifies the IP address 125.255.17.11 as the DHCP server for VLAN 3:

```
-> ip helper address 125.255.17.11 vlan 3
```

The following syntax identifies two DHCP servers for VLAN 4 at two different IP addresses:

```
-> ip helper address 125.255.17.11 125.255.18.11 vlan 4
```

To delete an IP address, use the **no** form of the **ip helper address** command. The IP address specified with this syntax is deleted. If an IP address is not specified with this syntax, then *all* IP helper addresses are deleted. The following command deletes a helper address for IP address 125.255.17.11:

```
-> no ip helper address 125.255.17.11
```

The following command deletes all IP helper addresses:

```
-> no ip helper address
```

Configuring BOOTP/DHCP Relay Parameters

Once the IP address of the DHCP server(s) is defined and the DHCP Relay is configured for either Global DHCP request or Per-VLAN DHCP request, you can set the following optional parameter values to configure BOOTP relay.

- The forward delay time.
- The hop count.
- The relay forwarding option.

The only parameter that is required for DHCP relay is the IP address to the DHCP server or to the next hop to the DHCP server. The default values can be accepted for forward delay, hop count, and relay forwarding option.

Alternately the relay function can be provided by an external router connected to the switch; in this case, the relay must be configured on the external router.

Setting the Forward Delay

Forward Delay is a time period that gives the local server a chance to respond to a client before the relay forwards it further out in the network.

The UDP packet sent by the client contains the elapsed boot time value. This is the amount of time, measured in seconds, since the client last booted. DHCP Relay does not process the packet unless the elapsed boot time value of the client is equal to or greater than the configured value of the forward delay time. If a packet contains an elapsed boot time value that is less than the specified forward delay time value, DHCP Relay discards the packet.

The forward delay time value applies to all defined IP helper addresses. The following command sets the forward delay value of 10 seconds:

```
-> ip helper forward-delay 10
```

Setting Maximum Hops

This value specifies the maximum number of relays the BOOTP/DHCP packet can go through until it reaches its server destination. This limit keeps packets from “looping” through the network. If a UDP packet contains a hop count equal to the hops value, DHCP Relay discards the packet. The following syntax is used to set a maximum of four hops:

```
-> ip helper maximum-hops 4
```

The hops value represents the maximum number of relays. The default maximum hops value is set to four. This maximum hops value applies only to DHCP Relay. All other switch services ignore this value.

Setting the Relay Forwarding Option

This value specifies if DHCP Relay must operate in a Standard or Per VLAN only forwarding mode. By default, the forwarding option is set to standard. To change the forwarding option value, enter **ip helper** followed by **standard** or **per-vlan-only**. For example:

```
-> ip helper standard  
-> ip helper per-vlan-only
```

Using Automatic IP Configuration

An additional function of the DHCP Relay feature enables a switch to broadcast a BootP or DHCP request packet at boot time to obtain an IP address for default VLAN 1. This function is separate from the previously described functions (such as Global DHCP, per-VLAN DHCP, and related configurable options) in that enabling or disabling automatic IP configuration does not exclude or prevent other DHCP Relay functionality.

Note. Automatic IP address configuration only supports the assignment of a *permanent* IP address to the switch. Make sure that the DHCP server is configured with such an address before using this feature.

Using automatic IP configuration also allows the switch to specify the type of request packet to send; BootP or DHCP. When the BootP/DHCP server receives the request packet from the switch, it processes the request and sends an appropriate reply packet. When the switch receives a reply packet from the BootP/DHCP server, one or more of the following occurs:

- The router port for VLAN 1 is assigned the IP address provided by the server.
- If the reply packet contains a subnet mask for the IP address, the mask is applied to the VLAN 1 router port address. Otherwise, a default mask is determined based upon the class of the IP address. For example, if the IP address is a Class A, B, or C address, then 255.0.0.0, 255.255.0.0, or 255.255.255.0 is used for the subnet mask.
- If the reply packet from the server contains a gateway IP address, then a static route entry of 0.0.0.0 is created on the switch with the gateway address provided by the server.

Note. If the VLAN 1 router port is already configured with an IP address, the switch does not broadcast a request packet at boot time even if automatic IP configuration is enabled.

To verify IP router port configuration for VLAN 1, use the [show ip interface](#) and [show ip routes](#) commands. For more information about these commands, refer to the *OmniSwitch AOS Release 8 CLI Reference Guide*.

Enabling Automatic IP Configuration

By default, this function is disabled on the switch. To enable automatic IP configuration and specify the type of request packet, use the [ip helper boot-up enable](#) command. For example:

```
-> ip helper boot-up enable DHCP
-> ip helper boot-up enable BOOTP
```

The next time the switch boots up, DHCP Relay broadcasts a BootP request packet as the default or DHCP request packet if DHCP is enabled to obtain an IP address for default VLAN 1.

To disable automatic IP configuration for the switch, use the [ip helper boot-up](#) command with the **disable** option, as shown below:

```
-> ip helper boot-up disable
```

Configuring UDP Port Relay

In addition to configuring a relay operation for BOOTP/DHCP traffic on the switch, it is also possible to configure relay for generic UDP service ports (NBNS/NBDD, other well-known UDP service ports, and service ports that are not well-known). This is done using UDP Port Relay commands to enable relay on these types of ports.

The UDP Port Relay function is separate from the previously described functions such as global DHCP, per-VLAN DHCP, and automatic IP configuration. Using UDP Port Relay does not exclude or prevent the other DHCP Relay functions from working. However, the following information is important to remember when configuring BOOTP/DHCP relay and UDP port relay:

- You can configure either the **ip helper** or **ip udp relay service** but not both at the same time.
- The **ip udp relay service** command can also be used to enable or disable relay for DHCP well known ports 67 and 68.
- If the BOOTP/DHCP relay service is disabled, the **ip helper** configuration is *not* retained and all dependent functionalities, like automatic IP configuration for VLAN 1 and telnet, is disrupted.
- The DHCP Relay Agent Service must support the BOOTP/DHCP protocol, specifically UDP port 67 and 68.
- Use port 67 and/or port 68 with the **ip udp relay service** command to assign the well-known service BOOTP.
- Relaying DHCP traffic is available on a global and per-VLAN basis. Using this function on a per-VLAN basis requires setting the DHCP relay forwarding mode to **per-vlan-only**. UDP port relay for generic services is only available on a per-VLAN basis, however it does not require enabling the **per-vlan-only** forwarding option.

Configuring UDP Port Relay for generic UDP services is a two-step process. The first step involves enabling UDP Port Relay on the generic service port. The second step involves specifying a VLAN that relays and forwards the traffic destined for the generic service port. Both steps are required and are described below.

Enabling/Disabling UDP Port Relay

By default, a global relay operation is enabled for BOOTP/DHCP relay well-known ports 67 and 68 that becomes active when an IP network host address for a DHCP server is specified. To enable or disable a relay operation for a UDP service port, use the **ip udp relay service** command. For example, the following command enables relay on the DNS well-known service port:

```
-> ip udp relay service DNS
```

To enable relay on a user-defined UDP service port, enter the service port number using the **ip udp relay port** command. For example, the following command enables relay on service port 3047:

```
-> ip udp relay port 3047
```

To disable a relay operation for a UDP service port, use the **no** form of the **ip udp relay service** command. For example, the following command disables relay on the DNS well-known service port:

```
-> ip udp relay no service DNS
```

To disable a relay operation for a UDP service port, use the **no** form of the **ip udp relay port** command. For example, the following command disables relay on the DNS well-known service port:

```
-> ip udp relay no port 3047
```

For more information about using the **ip udp relay service** and **ip udp relay port** command, see the *OmniSwitch AOS Release 8 CLI Reference Guide*.

Specifying a Forwarding VLAN

To specify which VLAN(s) UDP Port Relay forwards traffic destined for a generic UDP service port, use the **ip udp relay service vlan** command. For example, the following command assigns VLAN 5 as a forwarding VLAN for the DNS well-known service port:

```
-> ip udp relay service dns vlan 5
```

Note. The **ip udp relay service vlan** command works only if UDP Port Relay is already enabled on the specified service port. In addition, when assigning a VLAN to the BOOTP/DHCP service ports, set the DHCP relay forwarding mode to **per-vlan-only** first before trying to assign the VLAN.

To specify more than one VLAN with a single command, enter a range of VLANs. For example, the following command assigns VLANs 6 through 8 as forwarding VLANs for the NBNS/NBDD well-known service ports:

```
-> ip udp relay service nbns vlan 6-8
```

If UDP Port Relay was enabled on a not well-known service port, then enter the service port number instead of the service name along with the **port** keyword. For example, the following command assigns VLAN 100 as a forwarding VLAN for UDP service port 3047:

```
-> ip udp relay port 3047 vlan 100
```

To remove a VLAN association with a UDP service port, use the **no** form of the **ip udp relay service vlan** command. For example, the following command removes the VLAN 6 association with the NBNS well-known service port:

```
-> no ip udp relay service nbns vlan 6
```

For more information about using the **ip udp relay service vlan** command, see the *OmniSwitch AOS Release 8 CLI Reference Guide*.

How the Relay Agent Processes DHCP Packets from the Client

The following table describes how the relay agent processes DHCP packets received from clients when the Option-82 feature is enabled for the switch:

If the DHCP packet from the client ...	The relay agent ...
Contains a zero gateway IP address (0.0.0.0) and no Option-82 data.	Inserts Option-82 with unique information to identify the client source.
Contains a zero gateway IP address (0.0.0.0) and Option-82 data.	Drops the packet, keeps the Option-82 data and forwards the packet, or replaces the Option-82 data with its own Option-82 data and forwards the packet. The action performed by the relay agent in this case is determined by the agent information policy that is configured through the ip helper agent-information policy command. By default, this type of DHCP packet is dropped by the agent.
Contains a non-zero gateway IP address and no Option-82 data.	Drops the packet without any further processing.
Contains a non-zero gateway IP address and Option-82 data.	Drops the packet if the gateway IP address matches a local subnet, otherwise the packet is forwarded without inserting Option-82 data.

How the Relay Agent Processes DHCP Packets from the Server

When the relay agent receives a DHCP packet from the DHCP server, the agent:

- 1** Extracts the VLAN ID from the Circuit ID sub-option field in the packet and compares the MAC address of the IP router interface for that VLAN to the MAC address contained in the Remote ID sub-option field in the same packet.
- 2** Drops the DHCP packet if the IP router interface MAC address and the Remote ID MAC address are not the same.
- 3** If the two MAC addresses match, then a check is made to see if the port value in the Circuit ID sub-option field in the packet matches a port that is associated with the VLAN also identified in the Circuit ID sub-option field.
- 4** If the port information does not identify an actual port associated with the Circuit ID VLAN, then the agent tries to deliver the packet back to the port where the device is located.
- 5** If the port information does identify an actual port associated with the Circuit ID VLAN, then the agent strips the Option-82 data from the packet and unicasts the packet to the port identified in the Circuit ID sub-option.

Configuring DHCP Security Features

There are two DHCP security features available: DHCP relay agent information option (Option-82) and DHCP Snooping. The DHCP Option-82 feature enables the relay agent to insert identifying information into client-originated DHCP packets before the packets are forwarded to the DHCP server. The DHCP Snooping feature filters DHCP packets between untrusted sources and a trusted DHCP server and builds a binding database to log DHCP client information.

Although DHCP Option-82 is a subcomponent of DHCP Snooping, these two features are mutually exclusive. If the DHCP Option-82 feature is enabled for the switch, then DHCP Snooping is not available. The reverse is also true; if DHCP Snooping is enabled, then DHCP Option-82 is not available. In addition, the following differences exist between these two features:

- DHCP Snooping does require and use the Option-82 data insertion capability, but does not implement any other behaviors defined in RFC 3046.
- DHCP Snooping is configurable at the switch level and on a per-VLAN basis, but DHCP Option-82 is only configurable at the switch level.

The following sections provide additional information about each DHCP security feature and how to configure feature parameters using the Command Line Interface (CLI).

Using the Relay Agent Information Option (Option-82)

This implementation of the DHCP relay agent information option (Option-82) feature is based on the functionality defined in RFC 3046. By default DHCP Option-82 functionality is disabled. The [ip helper agent-information](#) command is used to enable this feature at the switch level.

When this feature is enabled, communications between a DHCP client and a DHCP server are authenticated by the relay agent. To accomplish this task, the agent adds Option-82 data to the end of the options field in DHCP packets sent from a client to a DHCP server. Option-82 consists of two suboptions: Circuit ID and Remote ID. The agent fills in the following information by default for each of these suboptions:

- **Circuit ID**—the VLAN ID and port from where the DHCP packet originated.
- **Remote ID**—the MAC address of the router interface associated with the VLAN ID specified in the Circuit ID suboption.

The [dhcp-snooping option-82-data-insertion](#) command is used to configure the type of data (base MAC address, system name, interface alias, or user-defined) that is inserted into the above Option-82 suboptions. The system name and user-defined text are reported in ASCII text format, but the MAC address is still reported in hex-based format.

By default, the relay agent drops client DHCP packets it receives that already contain Option-82 data. However, it is possible to configure an Option-82 policy to specify how such packets are treated. See [“Configuring DHCP Security Features” on page 22-16](#) for more information.

The DHCP Option-82 feature is only applicable when DHCP relay is used to forward DHCP packets between clients and servers associated with different VLANs. In addition, a secure IP network must exist between the relay agent and the DHCP server.

How the Relay Agent Processes DHCP Packets from the Client

The following table describes how the relay agent processes DHCP packets received from clients when the Option-82 feature is enabled for the switch:

If the DHCP packet from the client ...	The relay agent ...
Contains a zero gateway IP address (0.0.0.0) and no Option-82 data.	Inserts Option-82 with unique information to identify the client source.
Contains a zero gateway IP address (0.0.0.0) and Option-82 data.	<p>Drops the packet, keeps the Option-82 data and forwards the packet, or replaces the Option-82 data with its own Option-82 data and forwards the packet.</p> <p>The action performed by the relay agent in this case is determined by the agent information policy that is configured through the ip helper agent-information policy command.</p> <p>By default, this type of DHCP packet is dropped by the agent.</p>
Contains a non-zero gateway IP address and no Option-82 data.	Drops the packet without any further processing.
Contains a non-zero gateway IP address and Option-82 data.	Drops the packet if the gateway IP address matches a local subnet, otherwise the packet is forwarded without inserting Option-82 data.

How the Relay Agent Processes DHCP Packets from the Server

Note. If a DHCP server does not support Option-82, the server strips the option from the packet. If the server does support this option, the server will retain the Option-82 data received and send it back in a reply packet.

When the relay agent receives a DHCP packet from the DHCP server and the Option-82 feature is enabled, the agent will:

- 1** Extract the VLAN ID from the Circuit ID suboption field in the packet and compare the MAC address of the IP router interface for that VLAN to the MAC address contained in the Remote ID suboption field in the same packet.
- 2** If the IP router interface MAC address and the Remote ID MAC address are not the same, then the agent will drop the packet.
- 3** If the two MAC addresses match, then a check is made to see if the port value in the Circuit ID suboption field in the packet matches a port that is associated with the VLAN also identified in the Circuit ID suboption field.
- 4** If the port information does not identify an actual port associated with the Circuit ID VLAN, then the agent will drop the packet.
- 5** If the port information does identify an actual port associated with the Circuit ID VLAN, then the agent strips the Option-82 data from the packet and unicasts the packet to the port identified in the Circuit ID suboption.

Enabling the Relay Agent Information Option-82

Use the **ip helper agent-information** command to enable the DHCP Option-82 feature for the switch. For example:

```
-> ip helper agent-information enable
```

This same command is also used to disable this feature. For example:

```
-> ip helper agent-information disable
```

Note. Since this feature is not available on a per-VLAN basis, DHCP Option-82 functionality is not restricted to ports associated with a specific VLAN. Instead, DHCP traffic received on all ports is eligible for Option-82 data insertion when it is relayed by the agent.

Configuring a Relay Agent Information Option-82 Policy

As previously mentioned, when the relay agent receives a DHCP packet from a client that already contains Option-82 data, the packet is dropped by default. However, it is possible to configure a DHCP Option-82 policy that directs the relay agent to drop, keep, or replace the existing Option-82 data and then forward the packet to the server.

To configure a DHCP Option-82 policy, use the **ip helper agent-information policy** command. The following parameters are available with this command to specify the policy action:

- **drop**—The DHCP packet is dropped (the default).
- **keep**—The existing Option-82 data in the DHCP packet is retained and the packet is forwarded to the server.
- **replace**—The existing Option-82 data in the DHCP packet is replaced with local relay agent data and then forwarded to the server.

For example, the following commands configure DHCP Option-82 policies:

```
-> ip helper agent-information policy drop
-> ip helper agent-information policy keep
-> ip helper agent-information policy replace
```

Note. This type of policy applies to all DHCP packets received on all switch ports. In addition, if a packet that contains existing Option-82 data also contains a gateway IP address that matches a local subnet address, the relay agent will drop the packet and not apply any existing Option-82 policy.

Using DHCP Snooping

Using DHCP Snooping improves network security by filtering DHCP messages received from devices outside the network and building and maintaining a binding table (database) to track access information for such devices.

In order to identify DHCP traffic that originates from outside the network, DHCP Snooping categorizes ports as either trusted or untrusted. A port is trusted if it is connected to a device inside the network, such as a DHCP server. A port is untrusted if it is connected to a device outside the network, such as a customer switch or workstation.

Additional DHCP Snooping functionality provided includes the following:

- **Layer 2 DHCP Snooping**—Applies DHCP Snooping functionality to bridged DHCP client/server broadcasts without using the relay agent or requiring an IP interface on the client/server VLAN. See [“Layer 2 DHCP Snooping” on page 22-25](#) for more information.
- **IP Source Filtering**—Restricts DHCP Snooping port traffic to only packets that contain the proper client source information. The DHCP Snooping binding table is used to verify the client information for the port that is enabled for IP source filtering. See [“Using DHCP Snooping” on page 22-19](#) for more information.
- **Rate Limiting**—Limits the rate of DHCP packets on the port. This functionality is achieved using the QoS application to configure ACLs for the port. See [Chapter 27, “Configuring QoS,”](#) in the *OmniSwitch AOS Release 8 Network Configuration Guide* for more information.

When DHCP Snooping is first enabled, all ports are considered untrusted. It is important to then configure ports connected to a DHCP server inside the network as trusted ports. See [“Configuring the Port Trust Mode” on page 22-22](#) for more information.

If a DHCP packet is received on an untrusted port, then it is considered an untrusted packet. If a DHCP packet is received on a trusted port, then it is considered a trusted packet. DHCP Snooping only filters untrusted packets and will drop such packets if one or more of the following conditions are true:

- The packet received is a DHCP server packet, such as a DHCP OFFER, DHCP ACK, or DHCP NAK packet. When a server packet is received on an untrusted port, DHCP Snooping knows that it is not from a trusted server and discards the packet.
- The source MAC address of the packet and the DHCP client hardware address contained in the packet are not the same address.
- The packet is a DHCP RELEASE or DHCP DECLINE broadcast message that contains a source MAC address found in the DHCP Snooping binding table, but the interface information in the binding table does not match the interface on which the message was received.
- The packet includes a relay agent IP address that is a non-zero value.
- The packet already contains Option-82 data in the options field and the Option-82 check function is enabled. See [“Bypassing the Option-82 Check on Untrusted Ports” on page 22-22](#) for more information.

If none of the above are true, then DHCP Snooping accepts and forwards the packet. When a DHCP ACK packet is received from a server, the following information is extracted from the packet to create an entry in the DHCP Snooping binding table:

- MAC address of the DHCP client.
- IP address for the client that was assigned by the DHCP server.

- The port from where the DHCP packet originated.
- The VLAN associated with the port from where the DHCP packet originated.
- The lease time for the assigned IP address.
- The binding entry type; dynamic or static (user-configured).

After extracting the above information and populating the binding table, the packet is then forwarded to the port from where the packet originated. Basically, the DHCP Snooping feature prevents the normal flooding of DHCP traffic. Instead, packets are delivered only to the appropriate client and server ports.

DHCP Snooping Configuration Guidelines

Consider the following when configuring the DHCP Snooping feature:

- Layer 3 DHCP Snooping requires the use of the relay agent to process DHCP packets. As a result, DHCP clients and servers must reside in different VLANs so that the relay agent is engaged to forward packets between the VLAN domains. See [“Configuring BOOTP/DHCP Relay Parameters” on page 22-10](#) for information about how to configure the relay agent on the switch.
- Layer 2 DHCP Snooping does not require the use of the relay agent to process DHCP packets. As a result, an IP interface is not needed for the client/server VLAN. See [“Layer 2 DHCP Snooping” on page 22-25](#) for more information.
- Both Layer 2 and Layer 3 DHCP Snooping are active when DHCP Snooping is globally enabled for the switch or enabled on a one or more VLANs. See [“Enabling DHCP Snooping” on page 22-20](#) for more information.
- Configure ports connected to DHCP servers within the network as trusted ports. See [“Configuring the Port Trust Mode” on page 22-22](#) for more information.
- Make sure that Option-82 data insertion is always enabled at the switch or VLAN level. See [“Enabling DHCP Snooping” on page 22-20](#) for more information.
- DHCP packets received on untrusted ports that already contain the Option-82 data field are discarded by default. To accept such packets, configure DHCP Snooping to bypass the Option-82 check. See [“Bypassing the Option-82 Check on Untrusted Ports” on page 22-22](#) for more information.

Enabling DHCP Snooping

There are two levels of operation available for the DHCP Snooping feature: switch level or VLAN level. These two levels are exclusive of each other in that they both cannot operate on the switch at the same time. In addition, if the global DHCP relay agent information option (Option-82) is enabled for the switch, then DHCP Snooping at any level is not available. See [“How the Relay Agent Processes DHCP Packets from the Client” on page 22-15](#) for more information.

Note. DHCP Snooping drops server packets received on untrusted ports (ports that connect to devices outside the network or firewall). It is important to configure ports connected to DHCP servers as trusted ports so that traffic to/from the server is not dropped.

Switch-level DHCP Snooping

By default, DHCP Snooping is disabled for the switch. To enable this feature at the switch level, use the **ip udp relay no statistics** command. For example:

```
-> dhcp-snooping admin-state enable
```

When DHCP Snooping is enabled at the switch level, all DHCP packets received on all switch ports are screened/filtered by DHCP Snooping. By default, only client DHCP traffic is allowed on the ports, unless the trust mode for a port is configured to block or allow all DHCP traffic. See [“Configuring the Port Trust Mode” on page 22-22](#) for more information.

In addition, the following functionality is also activated by default when switch-level DHCP Snooping is enabled:

- The DHCP Snooping binding table is created and maintained. To configure the status or add a static entry to this table, use the **dhcp-snooping binding admin-state** command.
- MAC address verification is performed to compare the source MAC address of the DHCP packet with the client hardware address contained in the packet. To configure the status of MAC address verification, use the **dhcp-snooping mac-address-verification** command.
- Option-82 data is inserted into the packet and then DHCP reply packets are only sent to the port from where the DHCP request originated, instead of flooding these packets to all ports. To configure the status of Option-82 data insertion, use the **dhcp-snooping option-82-data-insertion** command.
- The base MAC address of the switch is inserted into the Circuit ID and Remote ID suboptions of the Option-82 field. To configure the type of data (base MAC address, system name, or user-defined) that is inserted into the Option-82 suboptions, use the **dhcp-snooping option-82 format** command. The system name and user-defined text are reported in ASCII text format, but the MAC address is still reported in hex-based format.

Note. On disabling DHCP Snooping functionality:

- Disabling Option-82 is not allowed if the binding table is enabled.
 - Enabling the binding table is not allowed if Option-82 data insertion is not enabled at either the switch or VLAN level.
-

VLAN-Level DHCP Snooping

To enable DHCP Snooping at the VLAN level, use the **dhcp-snooping vlan** command. For example, the following command enables DHCP Snooping for VLAN 200:

```
-> dhcp-snooping vlan 200 admin-state enable
```

When this feature is enabled at the VLAN level, DHCP Snooping functionality is only applied to ports that are associated with a VLAN that has this feature enabled. Up to 64 VLANs can have DHCP Snooping enabled.

Note. Enabling DHCP Snooping at the switch level is not allowed if it is enabled for one or more VLANs.

By default, when DHCP Snooping is enabled for a specific VLAN, MAC address verification and Option-82 data insertion is also enabled for the VLAN by default. To disable or enable either of these two features, use the **dhcp-snooping vlan** command with either the **mac-address-verification** or **option-82-data-insertion** parameters. For example:

```
-> dhcp-snooping vlan 200 mac-address-verification disable
-> dhcp-snooping vlan 200 option-82-data-insertion disable
```

Note. If the binding table functionality is enabled, disabling Option-82 data insertion for the VLAN is not allowed. See “[Configuring the DHCP Snooping Binding Table](#)” on page 22-23 for more information.

Note. If DHCP Snooping is *not* enabled for a VLAN, then all ports associated with the VLAN are considered trusted ports. VLAN-level DHCP Snooping does not filter DHCP traffic on ports associated with a VLAN that does not have this feature enabled.

Configuring the Port Trust Mode

The DHCP Snooping trust mode for a port determines whether or not the port accepts all DHCP traffic, client-only DHCP traffic, or blocks all DHCP traffic. The following trust modes for a port are configurable using the [dhcp-snooping port](#) command:

- **client-only**—The default mode applied to ports when DHCP Snooping is enabled. This mode restricts DHCP traffic on the port to only DHCP client-related traffic. When this mode is active for the port, the port is considered an untrusted interface.
- **trust**—This mode does not restrict DHCP traffic on the port. When this mode is active on a port, the port is considered a trusted interface. In this mode the port behaves as if DHCP Snooping is not enabled.
- **block**—This mode blocks all DHCP traffic on the port. When this mode is active for the port, the port is considered an untrusted interface.

To configure the trust mode for one or more ports, use the [dhcp-snooping port](#) command. For example, the following command changes the trust mode for port 1/12 on chassis 1 to blocked:

```
-> dhcp-snooping port 1/1/12 block
```

It is also possible to specify a range of ports. For example, the following command changes the trust mode for ports 2/1 through 2/10 on chassis 1 to trusted:

```
-> dhcp-snooping port 1/2/1-10 trust
```

Note. It is necessary to configure ports connected to DHCP servers within the network and/or firewall as trusted ports so that necessary DHCP traffic to/from the server is not blocked. Configuring the port mode as trusted also identifies the device connected to that port as a trusted device within the network.

Bypassing the Option-82 Check on Untrusted Ports

By default, DHCP Snooping checks packets received on untrusted ports (DHCP Snooping client-only or blocked ports) to see if the packets contain the Option-82 data field. If a packet does contain this field, the packet is dropped.

To allow untrusted ports to receive and process DHCP packets that already contain the Option-82 data field, use the [dhcp-snooping bypass option-82-check](#) command to disable the Option-82 check. For example:

```
-> dhcp-snooping bypass option-82-check enable
```

Configuring IP Source Filtering

IP source filtering applies to DHCP Snooping ports and restricts port traffic to only packets that contain the proper client source information in the packet. The DHCP Snooping binding table is used to verify the client information for the port that is enabled for IP source filtering.

Port Source Filtering -Filters based on source mac-address and source IP address.

VLAN Source Filtering - Filters based on VLAN ID, interface number, source mac-address and source IP address.

By default IP source filtering is disabled for a DHCP Snooping port. Use the **dhcp-snooping ip-source-filter** command to enable or disable this function.

For example, to enable source filtering on individual port 1/1 on chassis 1, enter:

```
-> dhcp-snooping ip-source-filter port 1/1/1 enable
```

To enable source filtering on link aggregate 2, enter:

```
-> dhcp-snooping ip-source-filter linkagg 2 enable
```

To enable source filtering on VLAN 10, enter:

```
-> dhcp-snooping ip-source-filter vlan 10 enable
```

Configuring the DHCP Snooping Binding Table

The DHCP Snooping binding table is automatically enabled by default when DHCP Snooping is enabled at either the switch or VLAN level. This table is used by DHCP Snooping to filter DHCP traffic that is received on untrusted ports.

Entries are made in this table when the relay agent receives a DHCPACK packet from a trusted DHCP server. The agent extracts the client information, populates the binding table with the information and then forwards the DHCPACK packet to the port where the client request originated.

To enable or disable the DHCP Snooping binding table, use the **dhcp-snooping binding admin-state** command. For example:

```
-> dhcp-snooping binding admin-state enable  
-> dhcp-snooping binding admin-state disable
```

Note that enabling the binding table functionality is not allowed if Option-82 data insertion is *not* enabled at either the switch or VLAN level.

In addition, it is also possible to configure static binding table entries. This type of entry is created using available **dhcp-snooping binding** command parameters to define the static entry. For example, the following command creates a static DHCP client entry:

```
-> dhcp-snooping binding 00:2a:95:51:6c:10 port 1/1/15 address 17.15.3.10 lease-  
time 3 vlan 200
```

To remove a static binding table entry, use the **no** form of the **dhcp-snooping binding** command. For example:

```
-> no dhcp-snooping binding 00:2a:95:51:6c:10 port 1/1/15 address 17.15.3.10  
lease-time 3 vlan 200
```

To view the DHCP Snooping binding table contents, use the **show dhcp-snooping binding** command. See the *OmniSwitch AOS Release 8 CLI Reference Guide* for example outputs of this command.

Configuring the Binding Table Timeout

The contents of the DHCP Snooping binding table resides in the switch memory. In order to preserve table entries across switch reboots, the table contents is automatically saved to the **dhcpBinding.db** file located in the **/flash/switch** directory.

Note. Do not manually change the **dhcpBinding.db** file. This file is used by DHCP Snooping to preserve and maintain binding table entries. Changing the file name or contents can cause problems with this functionality or with the DHCP Snooping application itself.

The amount of time, in seconds, between each automatic save is referred to as the binding table timeout value. By default, the timeout value is 300 seconds. To configure this value, use the **dhcp-snooping binding timeout** command. For example, the following command sets the timeout value to 1500 seconds:

```
-> dhcp-snooping binding timeout 1500
```

Each time an automatic save is performed, the **dhcpBinding.db** file is time stamped.

Synchronizing the Binding Table

To synchronize the contents of the **dhcpBinding.db** file with the binding table contents that resides in memory, use the **dhcp-snooping binding action** command. This command provides two parameters: **purge** and **renew**. Use the **purge** parameter to clear binding table entries in memory and the **renew** parameter to populate the binding table with the contents of the **dhcpBinding.db** file. For example:

```
-> dhcp-snooping binding action purge
-> dhcp-snooping binding action renew
```

Synchronizing the binding table is only done when this command is used. There is no automatic triggering of this function. In addition, it is important to note that synchronizing the binding table loads **dhcpBinding.db** file contents into memory. This is the reverse of saving the binding table contents in memory to the **dhcpBinding.db** file, which is done at automatic time intervals as defined by the binding table timeout value. See [“Configuring the Binding Table Timeout” on page 22-24](#) for more information.

Binding Table Retention

When the binding table is synchronized with the contents of the **dhcpBinding.db** file, any table entries with a MAC address that no longer appears in the MAC address table are cleared from the binding table. To retain these entries regardless of their MAC address table status, use the **dhcp-snooping binding persistency** command. For example:

```
-> dhcp-snooping binding persistency enable
```

When binding table retention is enabled, entries remain in the table for the term of their DHCP lease and are not removed even when the MAC address for the entry is cleared from the MAC address table.

To disable binding table retention, use the following command:

```
-> dhcp-snooping binding persistency disable
```

Layer 2 DHCP Snooping

By default, DHCP broadcasts are flooded on the default VLAN of the client/server port. If the DHCP client and server are both members of the same VLAN domain, the broadcast packets from these sources are bridged as Layer 2 traffic and not processed by the relay agent.

When DHCP Snooping is enabled at the switch level or for an individual VLAN, DHCP Snooping functionality is also applied to Layer 2 traffic. When DHCP Snooping is disabled at the switch level or disabled on the last VLAN to have snooping enabled on the switch, DHCP Snooping functionality is no longer applied to Layer 2 or Layer 3 traffic.

Verifying the DHCP Relay Configuration

To display information about the DHCP Relay and BOOTP/DHCP, use the **show** commands listed below.

For more information about the resulting displays from these commands, see the *OmniSwitch AOS Release 8 CLI Reference Guide*. An example of the output for the **show ip helper** command is also given in “Quick Steps for Setting Up DHCP Relay” on page 22-4.

show ip helper	Displays the current forward delay time, the maximum number of hops, the forwarding option (standard), and each of the DHCP server IP addresses configured.
show ip helper statistics	Displays the number of packets the DHCP Relay service has received and transmitted, the number of packets dropped due to forward delay and maximum hops violations, and the number of packets processed since the last time these statistics were displayed.
show ip udp relay	Displays the VLAN assignments to which the traffic received on the UDP service ports is forwarded. Displays the current configuration for UDP services by service name or by service port number.
show ip udp relay statistics	Displays the current statistics for each UDP port relay service. These statistics include the name of the service, the forwarding VLAN(s) configured for that service, and the number of packets the service has sent and received.
no ip helper statistics	Displays the VLAN assignments to which the traffic received on the specified UDP service port is forwarded.
show dhcp-snooping vlan	Displays a list of VLANs that have DHCP Snooping enabled and whether or not MAC address verification and Option-82 data insertion is enabled for each VLAN.
show dhcp-snooping port	Displays the DHCP Snooping trust mode for the port and the number of packets destined for the port that were dropped due to a DHCP Snooping violation.
show dhcp-snooping binding	Displays the contents of the DHCP Snooping binding table (database).

Notes.

- Use the **show ip udp relay** command to reset the IP helper statistics for VRF instances.
- Use the **no ip helper statistics** command to reset the generic UDP Relay Service related statistics.

23 Configuring an Internal DHCP Server

The Dynamic Host Configuration Protocol (DHCP) offers a framework to provide configuration information to client interfaces on an IPv4 or IPv6 IP network. DHCP is based on the Bootstrap Protocol (BOOTP) and provides additional capabilities, such as dynamic allocation of reusable network addresses and configuration options.

A DHCP server provides dynamic IP addresses on lease for client interfaces on a network. It manages a pool of IP addresses and information about client configuration parameters. The DHCP server obtains an IP address request from the client interfaces. After obtaining the requests, the DHCP server assigns an IP address, a lease period, and other IP configuration parameters, such as the subnet mask and the default gateway.

This chapter describes how to configure the internal DHCP server on the OmniSwitch.

In This Chapter

This chapter describes configuration of the DHCP server and how to modify the configuration through the Command Line Interface (CLI). CLI commands are used in the configuration examples; for more details on the syntax of commands, see the *OmniSwitch AOS Release 8 CLI Reference Guide*.

Configuration procedures described in this chapter include:

- [“DHCP Server Specifications” on page 23-2.](#)
- [“DHCP Server Default Values” on page 23-2.](#)
- [“Quick Steps to Configure Internal DHCP Server” on page 23-3.](#)
- [“DHCP Server Overview” on page 23-5](#)
- [“Interaction With Other Features” on page 23-6](#)
- [“Configuring DHCP Server on OmniSwitch” on page 23-7](#)
- [“DHCP Server Application Example” on page 23-12](#)
- [“Configuration File Parameters and Syntax” on page 23-15](#)
- [“Policy File Parameters and Syntax” on page 23-31](#)

DHCP Server Specifications

RFCs Supported	RFC 2131—Dynamic Host Configuration Protocol RFC 3315—Dynamic Host Configuration Protocol for IPv6 RFC 950—Internet Standard Subnetting Procedure RFC 868—Time Protocol RFC 1035—Domain Implementation and Specification RFC 1191—Path MTU Discovery
Platforms Supported	OmniSwitch 6860, 6860E
DHCP Server Implementation	BOOTP/DHCP
UDP Port Numbers	67 for Request and Response (IPv4) 547 for Request (IPv6) 546 for Response (IPv6)
IP address lease allocation mechanisms:	
BootP	Static BootP: IP address is allocated using the BootP configuration when the MAC address of the client is defined.
DHCP	Static DHCP: The network administrator assigns an IP address to the client. DHCP conveys the address assigned by the DHCP server to the client. Dynamic DHCP: The DHCP server assigns an IP address to a client for a limited period of time or until the client explicitly releases the address.
OmniSwitch IPv4 Configuration Files	dhcpd.conf dhcpd.pcy dhcpsrv.db
OmniSwitch IPv6 Configuration Files	dhcpdv6.conf dhcpdv6.pcy dhcpv6srv.db
Maximum number of leases	8000
Maximum lease information file size	375 KB

DHCP Server Default Values

Parameter Description	Command	Default Value/Comments
DHCP Server operation	dhcp-server status	disabled

Quick Steps to Configure Internal DHCP Server

DHCP server software is installed on the OmniSwitch to centrally manage IP addresses and other TCP/IP configuration settings for clients present on a network.

Follow the steps in this section for a quick tutorial on how to configure an internal DHCP server on the OmniSwitch.

Note. For detailed information on how to configure the DHCP server on OmniSwitch, see the [Configuring DHCP Server on OmniSwitch](#) section. The *.conf and *.pcy files can be created using VitalQIP, refer to the VitalQIP documentation for additional information.

- 1 Navigate to **/flash/switch** directory.

```
-> cd /flash/switch
```

- 2 Copy the **dhcpd.conf.template** file and save it as **dhcpd.conf**. The **dhcpd.conf** file can then be customized as necessary.

```
-> cp dhcpd.conf.template dhcpd.conf
```

- 3 Copy the **dhcpd.pcy.template** file and save it as **dhcpd.pcy**. The **dhcpd.pcy** file can then be customized as necessary.

- 4 Customize the **dhcpd.conf** and **dhcpd.pcy** files according to your requirements. Use the **vi** command to modify the existing configuration file.

```
-> vi dhcpd.conf
```

Declare dynamic DHCP options, global options, and server configuration parameters for client interfaces in the **dhcpd.conf** file. Add DHCP related information for a particular subnet.

For example, for the subnet 200.0.0.0, define the dynamic DHCP range, router option, domain name and other details using the following code:

```
server-identifier sample.example.com;

subnet 200.0.0.0 netmask 255.255.255.0
{
    dynamic-dhcp range 200.0.0.10 200.0.0.11
    {
        option subnet-mask 255.255.255.0;
        option routers 200.0.0.254;
        option domain-name-servers 200.0.0.99;
        option domain-name "example.com";
        option dhcp-lease-time 30000;
    }
}
```

Note. See “[Configuration File Parameters and Syntax](#)” on page 23-15 for details on what each of the optional keywords specify.

- 5 After entering the required information in the **dhcpd.conf** file. Type **:wq** to save the changes made to the **dhcpd.conf** file.

Notes.

- If the **dhcpd.conf** file is corrupted, the **dhcpd.conf.lastgood** file is used as a backup file.
 - If the **dhcpd.conf** file is updated successfully, then the **dhcpd.conf.lastgood** file is over written with the configurations present in the **dhcpd.conf** file.
 - Properly configured **dhcpd.conf** and **dhcpd.pcy** files can be transferred to the switch remotely instead of using the vi editor.
-

6 Restart the DHCP server using the **dhcp-server restart** command. The changes made in the **dhcpd.conf** file are applied to the OmniSwitch.

```
-> dhcp-server restart
```

Note. The **dhcp-server restart** command automatically updates the **dhcpd.conf**, **dhcpd.conf.lastgood** and **dhcpd.pcy** files.

7 Enable the DHCP server using the **dhcp-server** command.

```
-> dhcp-server enable
```

8 Check the IP address leases by entering the following command:

```
-> show dhcp-server leases
```

IP address	MAC address	Lease Granted	Lease Expiry	Type
200.255.91.53	10:fe:a2:e4:32:08	2010-01-16 11:38:47	2010-01-17 11:38:47	Dynamic
200.255.91.5	20:fe:a2:e4:32:08	2010-01-16 10:30:00	2010-01-18 10:30:00	Static
200.255.91.56	20:fe:a2:e4:33:08	2010-01-16 10:30:00	2010-01-18 10:30:00	Dynamic
200.255.91.58	20:fe:a2:e4:34:08	2010-01-16 10:30:00	2010-01-18 10:30:00	Dynamic

DHCP Server Overview

DHCP consists of two components:

- A protocol to supply client-specific configuration parameters from a DHCP server to a client.
- A mechanism to allocate network addresses to clients.

A DHCP server uses the Dynamic Host Configuration Protocol to provide initialization parameters to the clients in the network.

The DHCP process

DHCP is built on a client-server model, where a designated DHCP server allocates network addresses and delivers configuration parameters to dynamically configured client addresses. The process for a client to obtain its IP address through a DHCP server is as follows:

- 1 The client generates a DHCP request message via UDP broadcast.
- 2 The server listens for this request message.
- 3 The server responds with a DHCP reply and a valid IP address.
- 4 The server responds with a dynamic address in a defined range or one based on a MAC address.
- 5 The server leases the address for a specific time period.

Internal DHCP Server on OmniSwitch

The OmniSwitch internal DHCP server provides the abilities to:

- Enable or disable the DHCP server.
- Dynamically modify the DHCP configuration, using the `vi` editor, or through an accurately configured text file transferred to the switch.
- Restart the DHCP server.
- View the DHCP leases offered by the internal DHCP server.
- View the DHCP server statistics through the command line interface.

VitalQIP Server

The VitalQIP framework provides a complete solution for IP Address Management. The OmniSwitch runs the relevant components for a remote server such as Message Service and Active Lease that interact with the QIP server. The QIP server can be used to generate the required *conf* and *pcy* files which can be used on the OmniSwitch to allow it to act as a remote server.

OmniSwitch DHCP Server Management

The DHCP Server on the OmniSwitch is managed from VitalQIP by specifying the IP address of the OmniSwitch through which the VitalQIP server can manage the OmniSwitch. This can be the Loopback0 or other IP interface that is reachable by the VitalQIP server.

VitalQIP Message Service

This is the VitalQIP component that is present on the OmniSwitch acting as a remote server. This component allows the OmniSwitch to interact with other VitalQIP components. Also other services such as Active Lease Service register with the Message Server.

VitalQIP Active Lease Service

This component interacts with the VitalQIP server and provides the following capabilities:

- Viewing DHCP leases in VitalQIP
- Deleting Leases from VitalQIP.

Interaction With Other Features

This section contains important information about the internal DHCP server and its interaction with other OmniSwitch features. Refer to the specific chapter for each feature to get more detailed information about how to configure and use the feature.

Virtual Router Forwarding (VRF)

Address granting policies like DHCP are restricted to operate on addresses reachable through interfaces defined within the same VRF. DHCP server is supported only on the default VRF.

BootP/UDP Relay

The BootP/UDP relay is automatically disabled on the default VRF when the internal DHCP server is enabled on the switch.

IP Interfaces

The DHCP client gets a lease only if the switch has an IP interface and the DHCP server is configured for that particular subnet. If there are no IP address ranges defined for the incoming client interface, then the client is not assigned a lease.

In case of IP multinetting, the primary interface address is used to calculate the subnet of the interface. If there are no IP interfaces configured in the system, then the packet sent from the client is dropped.

VitalQIP Server

The VitalQIP framework provides a complete solution for IP Address Management. The OmniSwitch runs the relevant components for a remote server such as Message Service and Active Lease that interact with the VitalQIP server.

Configuring DHCP Server on OmniSwitch

The DHCP server implementation on OmniSwitch makes use of the policy, configuration, and server database files stored in the **/flash/switch** directory. The functions of the DHCP server related files are as follows:

- **DHCP Template files:** The **dhcpd(v6).conf.template** and **dhcpd(v6).pcy.template** files contain the default configuration parameters and policy parameters respectively.
- **DHCP Policy file:** The **dhcpd(v6).pcy** file initializes the global attributes for the DHCP server.
- **DHCP Configuration files:** The **dhcpd(v6).conf** file is used to configure specific DHCP server settings on the switch such as IP address ranges and options. The **dhcpd(v6).conf.lastgood** file is a backup for the **dhcpd(v6).conf** file.
- **DHCP Server Database file:** The **dhcpd(v6)Srv.db** file is activated only during takeover and server restart of the DHCP server. It contains lease details of the client IP addresses.

DHCP Template files

The **dhcpd(v6).conf.template** and **dhcpd(v6).pcy.template** files are provided as part of the AOS package. The template files are present in the **flash/switch** directory.

The **dhcpd(v6).conf.template** (configuration template) file contains the default configuration parameters required to setup the internal DHCP server. The **dhcpd(v6).conf.template** file provides a basic template to create a configuration file. Create a copy of the configuration template file and save it as **dhcpd(v6).conf** in the **flash/switch** directory. Modify the **dhcpd(v6).conf** file according to the network requirements.

The **dhcpd(v6).pcy.template** (policy template) file contains the default policy parameters for the internal DHCP server. The **dhcpd(v6).pcy.template** file provides a basic template to create a policy file. Create a copy of the policy template file and save it as **dhcpd(v6).pcy** file in the **flash/switch** directory. Modify the **dhcpd.pcy** file according to the network requirements.

Policy file

The policy file is used to configure the DHCP related policies according to user requirements. The **dhcpd(v6).pcy.template** file provides a basic template to create a policy file. The DHCP server policy parameters can be defined using the policy file. Ideally, most of the server parameters are kept static.

Example of a *dhcpd.pcy* File

```
PingDelay = 200
PingAttempts = 3
PingSendDelay = 1000
DefaultLease = 86400
```

Example of a *dhcpdv6.pcy* File

```
;
; QIP DHCPv6 Policy File
;
AbusiveClientMonitorPeriod=30
AbusiveClientWarningCount=30
```

```
AbusiveClientLockout=0
AddManualToGlobalDuidPool=1
AllowClientPacketsWithInvalidOptions=1
AllowUnencodedFqdn=1
CheckTransactionID=0
ClientFqdnOptionSupport=client
ClientHostNameProcessing=correct
ClientProcessingWaitTime=3000
CompressedLog=0
DefaultLease=60000
DHCPv6SocketAddr=2620:0:60:1480::3
DuidWarningsToEventLog=0
;
ForceClass=user
HonorRequestedLeaseTime=1
LogLeaseGrantAndRenew=0
MaxOutgoingDhcpMessageSize=1024
MaxPendingSeconds=120
MaxUnavailableTime=3600
MinimumRequestedLeaseTime=3600
NumberOfThreads=15

RegisteredClientsOnly=0
ReplyToUnmanagedInformationRequests=1
SendRequestedParamsOnly=1
SendUnicastOption=1
;ServerDuidDefault=0001000146e6ebb10003ba3cbb0d
ServerPreference=255
ServerStatefulMode=1
UpdateQIP=all
```

The updated **dhcpd(v6).pcy** file is effective only after the **dhcp-server restart** command is performed.

See the “[Policy File Parameters and Syntax](#)” on page 23-31 table for additional information on individual policy parameters and how to apply the policies for internal DHCP server on the OmniSwitch.

DHCP Configuration Files

The configuration files store the network information for the DHCP clients. There are two main DHCP configuration files that can be used to configure the DHCP server on OmniSwitch. They are:

- **dhcpd(v6).conf**
- **dhcpd(v6).conf.lastgood**

The following sections provide detailed information on the **dhcpd(v6).conf** and **dhcpd(v6).conf.lastgood** files.

***dhcpcd(v6).conf* File**

The **dhcpcd(v6).conf** file is used to declare DHCP options and global options for the DHCP clients. The **dhcpcd(v6).conf.template** file contains the default configuration parameters to setup the internal DHCP server. The template file can be copied to the **dhcpcd(v6).conf** file for editing.

The **dhcpcd(v6).conf** can be used to define the following:

- IP subnets
- Dynamic scopes and static bindings
- Subnet masks, DNS and default routers, and lease times
- User class or vendor class configurations

There are three types of statements in the configuration file:

- **Parameters:** Declare how, when, or what to provide to a client.
- **Declarations:** Describe the topology of the network and provide addresses for the clients. Parameters can be listed under declarations that override the global parameters.
- **Comments:** Provide a description for the parameters and declarations. Lines beginning with a hash mark (#) are considered comments and they are optional.

Example *dhcpcd.conf* File

```
#Global parameters that specify addresses and lease time.
option domain-name-servers 200.0.0.99;
option domain-name "example.com";
option dhcp-lease-time 20000;

#IP subnet
subnet 200.0.0.0 netmask 255.255.255.0
{
    #Dynamic scope and parameters that apply to this scope overriding global params.
    dynamic-dhcp range 220.0.0.100 220.0.0.130
    {
        option routers 220.0.0.254;
        option subnet-mask 255.255.255.0;
        option domain-name "scope_example.com";
        option domain-name-servers 192.168.1.1;
        option dhcp-lease-time 30000;
    }
}

#Static binding based on MAC address
manual-dhcp 00-01-02-03-04-05 220.0.0.140
{
    option subnet-mask 255.255.255.0;
}
}
```

Note. A subnet declaration must be included for every subnet in the network related to the DHCP server.

Details about valid parameters and declarations are listed in the table found in [“Configuration File Parameters and Syntax” on page 23-15.](#)

Example *dhcpdv6.conf* File

```
v6-server-identifier schumacher-nt.quadritek.com;

duid-pool { <- DUID pool for which we allocate IP across subnets
    00-03-02-be-1a-0f-cd-14-67-98-05-56-98-98-67-cd-69-01
    00-02-00-00-00-09-*
    00-02-00-00-00-08-*
    00-02-00-00-00-07-*
    00-01-*
}
x-duid-pool { <- Excluded DUID pool for which we do not allocate IP
    00-02-00-00-00-09-0c-c0-84-d3-03-00-09-12
}

v6-subnet 2620:0000:0060:1480:0000:0000/97 { <- IPv6 subnet
    x-duid-pool { <- Excluded DUID pool for this subnet
        00-02-00-00-00-09-0c-c0-84-d3-03-00-09-13
        00-02-00-00-00-09-0c-c0-84-d3-03-00-09-19
    }
    policy send-unicast-option-enabled false; <- policy options applicable
    policy subnet-unavailable-threshold 90;
    policy subnet-unavailable-descent-threshold 85;
    policy minimum-requested-lifetime 800;
    option renewal-time 700000; <- Options applicable
    option rebinding-time 1000000;
    option preferred-lifetime 2000000;
    option valid-lifetime 3000000;
    option dns-recursive-name-server 2001:468:603:c0e0::12001:468:603:c0e0::2;

    v6-manual-dhcp duid 00-02-00-00-00-09-0c-c0-84-d3-03-00-0a-11
2620:0000:0060:1480::1f01 { <- Manual DUID mapping
    option posix-timezone "MST7MDT6,116/02:00:00,298/02:00:00";
}

    v6-dynamic-dhcp range 2620:0000:0060:1480::2000 2620:0000:0060:1480::2500
{ <- Dynamic range of IPs
    policy minimum-requested-lifetime 650;
    policy rapid-commit-enabled true;
    policy excluded-user-classes "bronze" "gold" "silver";
    policy excluded-vendor-classes enterprise 311 "MSFT 5.0" enterprise 546
    "SIP Phone";
    option dns-recursive-name-server 2620:0000:0060:1480::3
2620:0000:0060:1480::4;
    option domain-search-list malvern2.lucent.com murrayhill2.lucent.com;
    option posix-timezone "CST6CDT5,116/02:00:00,298/02:00:00";
    option sntp-servers 2620:0000:0060:1480::5 2620:0000:0060:1480::6;
}
}

v6-subnet 2620:0000:0060:1481/64 {
    policy minimum-requested-lifetime 800;
    v6-manual-dhcp duid 00-02-00-00-00-09-0c-cd-84-d3-03-00-0a-14
2620:0000:0060:1481::1f01 {
    option posix-timezone "MST7MDT6,116/02:00:00,298/02:00:00";
}
}
```

```
v6-manual-dhcp duid 00-02-00-00-00-09-0c-cd-84-d3-03-00-0a-13 iaid 1001
2620:0000:0060:1481::1f02 {
    option posix-timezone "MST7MDT6,116/02:00:00,298/02:00:00";
}
v6-manual-dhcp duid 00-02-00-00-00-09-0c-cd-84-d3-03-00-0a-13 iaid 1002
2620:0000:0060:1481::1f03 {
    option posix-timezone "MST7MDT6,116/02:00:00,298/02:00:00";
```

***dhcpd(v6).conf.lastgood* File**

The **dhcpd(v6).conf.lastgood** file is used as a backup file when the **dhcpd(v6).conf** file is corrupted. If the **dhcpd(v6).conf** file is affected, then the DHCP server generates an error. In such an instance, the DHCP server configuration is updated according to the **dhcpd(v6).conf.lastgood** file. The **dhcpd(v6).conf.lastgood** file is now used to configure the internal DHCP server, provide IP addresses on lease, and maintain DHCP related information.

The **dhcpd(v6).conf.lastgood** file is overwritten with the configurations in the **dhcpd(v6).conf** file when the DHCP configurations are setup or updated and the internal DHCP server is restarted successfully. At this point, the **dhcpd(v6).conf** and **dhcpd(v6).conf.lastgood** files are identical.

If any modifications are made in the **dhcpd(v6).conf** file, the DHCP server must be restarted so that the configuration is updated on the OmniSwitch. The **dhcp-server restart** command automatically updates the **dhcpd(v6).conf** and **dhcpd(v6).conf.lastgood** files.

DHCP Server Database file

The **dhcp(v6)Srv.db** or the DHCP server database or lease file is initialized when the DHCP server function takes over or is restarted. The DHCP server database file contains the mappings between a client IP address and MAC address, referred to as a binding.

There are two types of bindings:

Static bindings - Map a single MAC address to a single IP address.

Dynamic bindings - Dynamically map a MAC address to an IP address from a pool of IP addresses. Details of both the dynamic and static bindings, are stored in the **dhcp(v6)Srv.db** file.

The **dhcp(v6)Srv.db** file is read when the switch reloads or the DHCP service restarts. The server database file is read-only and must not be opened or edited by the user. This file provides an account of all the subnets configured and helps in detecting all the unmanaged leases. The lease file is synchronized with the DHCP server periodically based on a timer for smooth operation during takeover and restart. The default value of this timer is 1 minute. The timer ping mechanism is used to prevent duplicate IP address allocations to clients in the same subnet. The lease file synchronization is applicable for both chassis and stack based OmniSwitch products.

DHCP Server Application Example

In this application example the clients or hosts obtain their IP addresses from the internal DHCP server configured on the OmniSwitch. DHCP clients initially have no IP address and are provided IP addresses by the DHCP server.

The external router supports the DHCP relay functionality so that it can forward DHCP frames sent to and from the DHCP clients and server on the OmniSwitch.

In the following diagram, the OmniSwitch is acting as a DHCP server and the external router is acting as the DHCP relay agent. The DHCP requests from the clients (eg: 200.0.0.X) are relayed from the external router to the OmniSwitch acting as a DHCP server. The internal DHCP server on OmniSwitch processes the requests and leases IP addresses based on the DHCP server configuration.

- 1** The DHCP clients are present in the 200.0.0.X network connected to the external router and also in the 220.0.0.X network directly attached to the OmniSwitch.
- 2** The default **dhcpd.pcy** file can be used to configure the DHCP server global parameters.
- 3** The **dhcpd.conf** file defines the 200.0.0.X network and 220.0.0.X network.
- 4** The subnet mask and DNS server address are global declarations since they are the same for each subnet.
- 5** The default router address and lease times are declared as a part of the scope since they are different for each subnet.
- 6** The resulting sample code for the **dhcpd.conf** file is as follows:

```
#Global parameters
option subnet-mask 255.255.255.0;
option domain-name-servers 200.0.0.99;
subnet 200.0.0.0 netmask 255.255.255.0
{
    dynamic-dhcp range 200.0.0.11 200.0.0.20
    {
        option routers 200.0.0.254;
        option dhcp-lease-time 20000;
    }
}

subnet 220.0.0.0 netmask 255.255.255.0
{
    dynamic-dhcp range 220.0.0.100 220.0.0.105
    {
        option routers 220.0.0.254;
        option dhcp-lease-time 30000;
    }
}
```

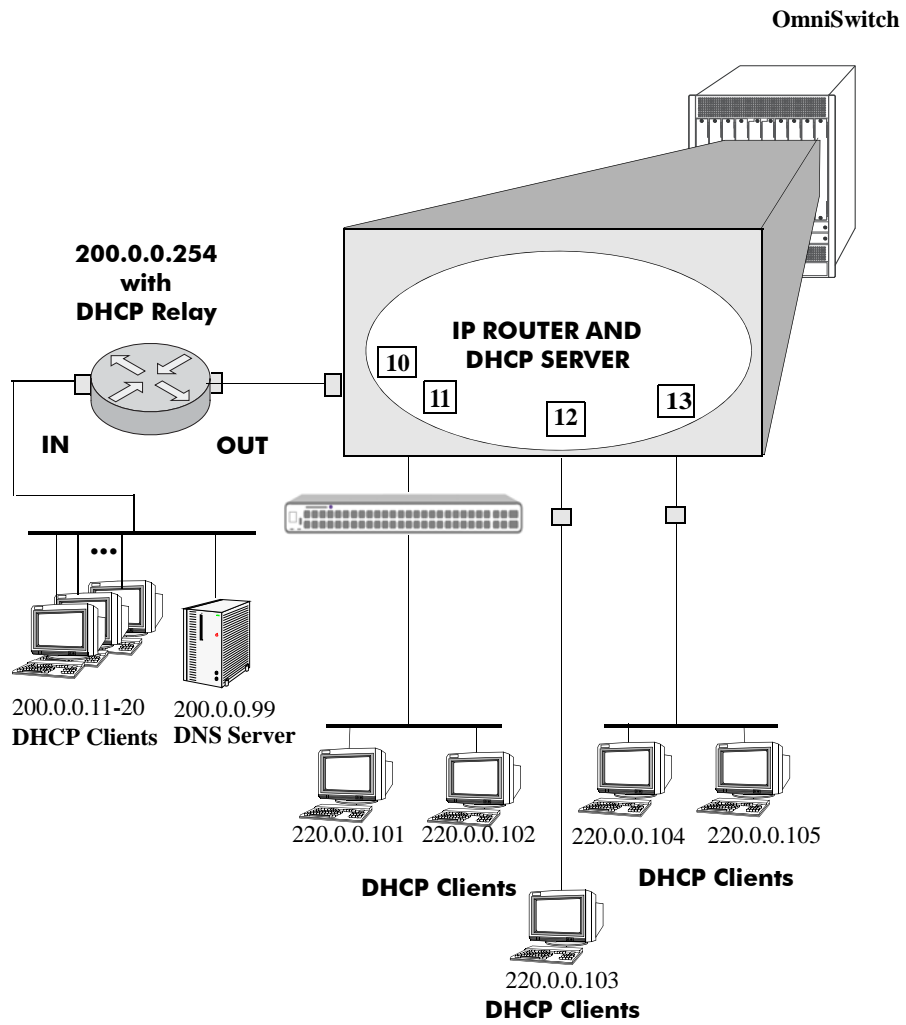

Illustration of Internal DHCP Server Application Example

Verifying the DHCP Server Configuration

To display information about the DHCP Server configuration and statistics use the **show** commands listed below:

show dhcp-server leases	Displays the leases offered by the DHCP server.
show dhcp-server statistics	Displays the statistics of the DHCP server.

For more information about the resulting displays from these commands, see the *OmniSwitch AOS Release 8 CLI Reference Guide*.

Configuration File Parameters and Syntax

The following table provides detailed information about the configuration file options and syntax specifications.

Option Code	dhcpd.conf Key-word	dhcpd.conf example	Data type	Default Value	Description
1	subnet-mask	option subnet-mask 255.255.0.0;	N/A	Same as in Subnet Profile	Specifies the client's subnet mask. If both the subnet mask and the router option are specified in a DHCP reply, the subnet mask option must be specified before the router option.
2	time-offset	option time-offset 1000;	numeric_ signed	N/A	Specifies the offset of the client's subnet (in seconds) from Coordinated Universal Time (also referred to as UTC). A positive offset indicates a location east of the zero meridian and a negative offset indicates allocation west of the zero meridian. For example, to enter a time offset for a client subnet located in the Eastern Standard Timezone (5 hours west of the UTC zero meridian), enter -18000.
3	routers	option routers 100.0.0.1;	N/A	Same as in Subnet Profile	Lists the IP addresses for the routers for each client subnet defined. Routers should be listed in order of preference.
4	time-server	option time-server 10.10.0.10;	N/A	Same as in Subnet Profile	Specifies IP address of the RFC 868 time server available to the client.
5	name-servers	option name-servers 10.10.0.100;	ip_address_ list	N/A	Specifies IP address of the IEN-116 name server available to the client.
6	domain-name-servers	option domain-name-servers 10.10.0.30;	N/A	Same as in Subnet Profile	Lists the DNS (STD 13, RFC 1035) name server IP address(es) available to the client. Servers should be listed in order of preference.
7	log-servers	option log-servers 10.10.0.100;	ip_address_ list	N/A	Specifies the IP address of the MIT-LCS UDP log server available to the client.
8	cookie-servers	option cookie-servers 10.10.0.100;	ip_address_ list	N/A	Specifies the IP address of the RFC 865 cookie server available to the client.
9	lpr-servers	option lpr-servers 10.10.0.100;	ip_address_ list	N/A	Specifies IP address of the line printer server available to the client.
10	impress-servers	option impress-servers 10.10.0.100;	ip_address_ list	N/A	Specifies IP address of the Imagen Impress server available to the client.

Option Code	dhcpd.conf Key-word	dhcpd.conf example	Data type	Default Value	Description
11	resource-location-servers	option resource-location-servers 10.10.0.100;	ip_address_list	N/A	Specifies the IP address of the Resource Location server available to the client.
12	host-name	option host-name "bgp000014bgs";	N/A	Same as in Object Profile	Specifies the name of the client. If the host name is defined in an option template, it overrides any definition in the Object Profile.
13	boot-size	option boot-size 30;	numeric	N/A	Specifies the length of the default boot image of the client. The maximum file length is 65,535 bytes.
14	merit-dump	option merit-dump "m_dump";	text	N/A	Specifies the pathname of the file where the core image is to be dumped in the occurrence of a crash. The path is formatted as a character string consisting of characters from the Network Virtual Terminal (NVT) ASCII character set.
15	domain-name	option domain-name "abc.example.com";	N/A	Same as in Subnet Profile	Specifies the domain name to resolve hostnames via the Domain Name Service (DNS).
16	swap-server	option swap-server 10.10.0.100;	ip address	N/A	Specifies the IP address of the client's swap server.
17	root-path	option root-path "/root";	text	N/A	Specifies the pathname that contains the client's root directory or partition. The path is formatted as an NVT ASCII character string.
18	extensions-path	option extensions-path "/ext";	text	N/A	Specifies a text string to denote a file, retrievable via Trivial File Transfer Protocol (TFTP). The file contains information that can be interpreted in the same way as the 64-octet vendor-extension field within the BOOTP response. The length of the file is unconstrained. All references to instances of the BOOTP Extensions Path field within the file are ignored.
19	ip-forwarding	option ip-forwarding false;	boolean	False	Select True to configure the IP layer to enable packet forwarding. Select False to disable packet forwarding.
20	non-local-source-routing	option non-local-source-routing false;	boolean	False	Select True to configure the IP layer to forward datagrams with non-local source routes. Select False to disable forwarding of the datagrams.

Option Code	dhcpd.conf Key-word	dhcpd.conf example	Data type	Default Value	Description
21	policy-filter	option policy-filter 10.10.0.100 255.255.0.0;	ip_address_mask_list	N/A	Specifies policy filters for nonlocal source routing. The filters consist of the IP address list and masks. This data specifies destination and mask pairs with which to filter incoming source routes. The client should discard any source-routed datagram whose next hop address does not match one of the filters.
22	max-dgram-reassembly	option max-dgram-reassembly 576;	numeric	N/A	Specifies the maximum reassembly size of the datagram. Enter a value between 576 and 65,535.
23	default-ip-ttl	option default-ip-ttl 1;	numeric	N/A	Specifies the default time-to-live (in seconds) to use on outgoing datagrams as an octet between 1 and 255.
24	path-mtu-aging-timeout	option path-mtu-aging-timeout 10;	numeric	N/A	Specifies the maximum time to be allotted for Path Maximum Transmit Unit (MTU) values to be discovered. The timeout is in seconds, from 0 to 2,147,483,647.
25	path-mtu-plateau-table	option path-mtu-plateau-table 68;	numeric_list	N/A	Identifies a table of MTU sizes to use when performing Path MTU discovery as defined in RFC 1191. The table is formatted as a list. Minimum value is 68. Maximum value is 65,535.
26	interface-mtu	option interface-mtu 68;	numeric	N/A	Specifies the Maximum Transmit Unit (MTU) to be used on the related interface. MTU is the frame size in a TCP/IP network. Valid range from 68 to 65,535.
27	all-subnets-local	option all-subnets-local false;	boolean	False	True indicates that all subnets share the same MTU as of the subnet to which the client user is directly connected False indicates that some of the subnets connected may have smaller MTUs.
28	broadcast-address	option broadcast-address 10.10.255.255	N/A	Same as in Subnet Profile	Specifies the broadcast address used on the client's subnet.
29	perform-mask-discovery	option perform-mask-discovery false;	boolean	False	True indicates that the client should perform subnet mask discovery. False indicates that no mask discovery must be performed.

Option Code	dhcpd.conf Key-word	dhcpd.conf example	Data type	Default Value	Description
30	mask-supplier	option mask-supplier false;	boolean	False	True indicates that response to the subnet mask request should use Internet Control Message Protocol (ICMP). False indicates the subnet mask should not respond using ICMP.
31	router-discovery	option router-discovery false;	boolean	False	True allows router discovery to be performed as defined in RFC 1256. False indicates that router discovery need not be performed.
32	router-solicitation-address	option router-solicitation-address 10.10.0.100;	ip_address	N/A	Specifies the IP address where router solicitation requests should be transmitted.
33	static-routes	option static-routes 10.10.0.100 10.10.0.200;	ip_address_ pair_list	N/A	Specifies the list of static routes that the client should install in its routing cache. If multiple routes to the same destination are specified, they are listed in descending order of priority. The routes consist of a list of IP address pairs. The first address is the router for the destination. The default route (0.0.0.0) is an illegal destination for a static route.
34	"trailer-encapsulation	option trailer-encapsulation false;	boolean	False	Select True to identify whether the client should negotiate the use of trailers (RFC 893) when using the Address Resolution Protocol (ARP). Select False to prevent the use of trailers.
35	arp-cache-timeout	option arp-cache-timeout 10;	numeric	N/A	Specifies the time-out in seconds for ARP cache entries, from 0 to 2,147,483,647.
36	ieee802-3-encapsulation	option ieee 802-3-encapsulation false;	boolean	False	Use this option to identify the use of Ethernet Version 2 (RFC 894) or IEEE 802.3 (RFC 1042) encapsulation for Ethernet interface. Select True to use RFC 1042 encapsulation. Select False to use RFC 894 encapsulation.
37	default-tcp-ttl	option default-tcp-ttl 1;	numeric	N/A	Defines the default time-to-live (in seconds) to use when sending TCP segments. Enter a value from 1 to 255.

Option Code	dhcpd.conf Key-word	dhcpd.conf example	Data type	Default Value	Description
38	tcp-keepalive-interval	<code>option tcp-keepalive-interval 10;</code>	numeric	N/A	Specifies the amount of time, in seconds, to wait before sending a keep alive message on a TCP connection. A value of 0 indicates keep alive messages on connections should not be generated unless specifically requested to do so by an application. Valid range from 0 to 2,147,483,647
39	tcp-keepalive-garbage	<code>option tcp-keepalive-garbage false;</code>	boolean	False	Specifies if the TCP keep alive messages should be sent with a garbage octet for compatibility with older implementations. Select True to enable a garbage octet to be sent. Select False to prevent a garbage octet being sent.
40	nis-domain	<code>option nis-domain "abc.example.com";</code>	text	Same as in Subnet Profile	Network Information Service (NIS) support is provided on SunOS 4.1x, Solaris 2.x and HP_UX10 only. Specify the NIS domain name. The domain is formatted as a character string from the NVT ASCII character set.
41	nis-servers	<code>option nis-servers 10.10.0.30;</code>	ip_address_list	Same as in Subnet Profile	Lists the IP addresses (in order of preference) identifying the NIS (Network Information Service) servers available to the client
42	ntp-servers	<code>option ntp-servers 10.10.0.50</code>	ip_address_list	Same as in Subnet Profile	Lists the IP addresses (in order of preference) indicating NTP (RFC 868) servers available to the client.
43	vendor-specific	<code>option vendor-specific vspInfo;</code>	hexadecimal_text	N/A	Used by clients and servers to exchange vendor-specific information. The value for this option is defined in the hexadecimal format. The definition of this information is vendor specific. The vendor is indicated in the vendor class identifier option. Servers not equipped to interpret the vendor specific information sent by a client must ignore the related data. Clients that do not receive desired vendor-specific information should attempt to operate without the related data. The clients must announce that they are working in a degraded mode.

Option Code	dhcpd.conf Key-word	dhcpd.conf example	Data type	Default Value	Description
44	netbios-name-servers	option netbios-name-servers 10.10.0.100;	ip_address_list	N/A	Specifies a list of RFC 1001/1002 NBNS name servers listed in order of preference. This is a NetBIOS name server (NBNS) or WINS server option.
45	netbios-dd-servers	option netbios-dd-servers 10.10.0.100;	ip_address_list	N/A	Specifies a list of RFC 1001/1002 NBDD servers listed in order of preference. This is a NetBIOS datagram distribution server (NBDD) option.
46	netbios-node-type	option netbios-node-type 1;		N/A	Allows NetBIOS over TCP/IP clients, which are configurable as described in RFC 1001/1002. The value is specified as a single octet, which identifies the client type, as follows:- ValueNode type 0x1B-node 0x2P-node 0x4M-node 0x8H-node
47	netbios-scope	option netbios-scope "xyz";	text	N/A	This NetBIOS scope option specifies the NetBIOS over TCP/IP scope parameter for the client, as specified in RFC 1001/1002.
48	font-servers	option font-servers 10.10.0.100;	ip_address_list	N/A	Specifies a list of X Window System Font servers available to the client. Servers should be listed in order of preference.
49	x-display-manager	option x-display-manager 10.10.0.100;	ip_address_list	N/A	Specifies a IP address list of systems that are running the X Window System Display Manager and are available to the client.
51	dhcp-lease-time	option dhcp-lease-time 4294967295;	time_interval	Unlimited	Used in a client request (DHCPDISCOVER or DHCPREQUEST) to allow the client to request a lease time for the IP address. In a server reply (DHCPOFFER), a DHCP server uses this option to specify the lease time offered. Selecting the Limited option allows you to set a lease time of up to 999 days, 999 hours, and 999 minutes.

Option Code	dhcpd.conf Key-word	dhcpd.conf example	Data type	Default Value	Description
52	dhcp-option-overload	option dhcp-option-overload 1;	1, 2 or 3	N/A	<p>Used to indicate that the DHCP server name or file fields are being overloaded by using them to carry DHCP options. A DHCP server inserts this option if the returned parameters exceed the usual space allotted for options. If this option is present, the client interprets the specified additional fields after it concludes the interpretation of the standard option fields. Legal values for this option are as follows:</p> <p>1 - The “file” field is used to hold options 2 - The “sname” field is used to hold options 3 - Both fields are used to hold options</p>
58	dhcp-renewal-time	option dhcp-renewal-time 10;	numeric	N/A	Specifies the time interval from address assignment until the client transitions to the renewing state. You can enter any value from 0 to 999,999,999 seconds.
59	dhcp-rebinding-time	option dhcp-rebinding-time 10;	numeric	N/A	Specifies the time interval from address assignment until the client transitions to the rebinding state. You can enter any value from 0 to 999,999,999 seconds.
61	dhcp-client-identifier	option dhcp-client-identifier xyz;	text	N/A	<p>Used by DHCP clients to specify their unique identifier. DHCP servers use this value to index their database of address bindings. It is unique for all clients in an administrative domain. The client identifier consists of type-value pairs.</p> <p>Ex: A hardware type and hardware address. In this case, the type field should be one of the Address Resolution Protocol (ARP) hardware types defined in RFC 1700. A hardware type - 0 indicates a domain name. Vendors and system administrators are responsible for choosing the unique client-identifiers.</p>

Option Code	dhcpd.conf Key-word	dhcpd.conf example	Data type	Default Value	Description
62	novell-netware-domain-name	option novell-netware-domain-name "xyz";	text	N/A	Used to convey the NetWare/IP domain name used by the NetWare/IP product. The NetWare/IP Domain in the option is a Network Virtual Terminal (NVT) ASCII text string. You can enter up to 255 characters.
63	novell-netware-info	option novell-netware-info [0100];	sub-option	N/A	This NetWare/IP option code is used to convey all the NetWare/IP related information except for the NetWare/IP domain name. If <code>NWIP_EXIST_IN_OPTIONS</code> <code>_AREA</code> sub-option is set, one or more of the other suboptions may be present.
64	dhcp-nis+-domain	option dhcp-nis+-domain "xyz";	text	Same as in Subnet profile	Specifies the NIS domain name. The domain is formatted as a character string from the NVT ASCII character set Network Information Service (NIS) support is provided on SunOS 4.1x, Solaris 2.x and HP_UX10 only.
65	dhcp-nis+-servers	option dhcp-nis+-servers 10.10.0.100;	ip_address_list	Same as in Subnet profile	Lists the IP addresses identifying the NIS servers available to the client in order of preference
66	dhcp-tftp-server	option dhcp-tftp-server "xyz";	text	N/A	Used to identify a Trivial File Transfer Protocol (TFTP) server when the server name field in the DHCP header has been used for DHCP options.
67	dhcp-bootfile-name	option dhcp-bootfile-name "xyz";	text	N/A	This option is used to identify a bootfile when the file field in the DHCP header has been used for DHCP options.
68	dhcp-mobile-ip-home-agent	option dhcp-mobile-ip-home-agent 10.10.0.100;	ip_address_list	N/A	This option specifies an IP address list indicating mobile IP home agents available to the client. Agents should be listed in order of preference.
69	dhcp-smtp-server	option dhcp-smtp-server 10.10.0.100;	ip_address_list	N/A	Specifies a list of SMTP servers available to the client. Servers should be listed in order of preference.
70	dhcp-pop3-server	option dhcp-pop3-server 10.10.0.100;	ip_address_list	N/A	Specifies a list of POP3 servers available to the client. Servers should be listed in order of preference.
71	dhcp-nntp-server	option dhcp-nntp-server 10.10.0.100;	ip_address_list	N/A	This Network News Transport Protocol (NNTP) server option specifies a list of NNTP servers available to the client. Servers should be listed in order of preference.

Option Code	dhcpd.conf Key-word	dhcpd.conf example	Data type	Default Value	Description
72	dhcp-www-server	option dhcp-www-server 10.10.0.100;	ip_address_ list	N/A	Specifies a list of WWW servers available to the client. Servers should be listed in order of preference.
73	dhcp-finger-server	option dhcp-finger-server 10.10.0.100;	ip_address_ list	N/A	Specifies a list of Finger servers available to the client. Servers should be listed in order of preference.
74	dhcp-irc-server	option dhcp-irc-server 10.10.0.100;	ip_address_ list	N/A	Specifies a list of IRC servers available to the client. Servers should be listed in order of preference.
75	dhcp-streettalk-server	option dhcp-streettalk-server 10.10.0.100;	ip_address_ list	N/A	Specifies a list of StreetTalk servers available to the client. Servers should be listed in order of preference.
76	dhcp-stda-server	option dhcp-stda-server 10.10.0.100;	ip_address_ list	N/A	Specifies a list of STDA (StreetTalk Directory Assistance) servers available to the client. Servers should be listed in order of preference.
78	slp-directory-agent	option slp-directory-agent [000a0a0064];	sub-option		Specifies the location of one or more SLP Directory Agents. The SLP Directory Agent option contains the following suboptions:
	Mandatory		boolean	False	This sub-option may be set to either True or False. If it is set to True, the SLP UserAgent or Service Agent so configured must not employ either active or passive multicast discovery of Directory Agents.
	Directory Agent Address		ip_address_ list	N/A	This sub-option allows a IP address list to be specified. The list must be in order of preference, if an order of preference is desired.
79	slp-service-scope	option slp-service-scope [0078797a];	sub-option		Specifies the scopes that a SLP Agent is configured to use. It contains the following suboptions: If set to False , static configuration takes precedence over the DHCP provided scope list. If set to True , the entries in the Scope List must be used by the SLP Agent.
	Scope Listtext			N/A	This sub-option is a comma-delimited list of scopes. The list is case insensitive.

Option Code	dhcpd.conf Key-word	dhcpd.conf example	Data type	Default Value	Description
	Mandatory		boolean	FALSE	This sub-option determines whether SLP Agents override their static configuration for scopes in the Scope List. This allows DHCP administrators to implement a policy of assigning a set of scopes to Agents for service provision.
85	novell-nds-servers	option novell-nds-servers 10.10.0.100;	ip_address_list	N/A	Specifies one or more NDS servers for the client to contact for access to the NDS database. Servers should be listed in order of preference.
86	novell-nds-tree-name	option novell-nds-tree-name "xyz" ;	text	N/A	Specifies the name of the NDS tree which the client can contact. Maximum 255 characters.
87	novell-nds-context	option novell-nds-context "xyz" ;	text	N/A	Specifies the initial NDS context the client should use. Maximum 255 characters.
88	broadcast-multicast-service-domain	option broadcast-multicast-service-domain [0378797a00];	name_list	N/A	Lists server names that host the Broadcast and Multicast services that are specified as domain names.
89	broadcast-multicast-service-address	option broadcast-multicast-service-address 10.10.0.100;	ip_address_list	N/A	Lists server names that host the Broadcast and Multicast services that are specified as IPV4 addresses.
98	user-authentication-protocol	option user-authentication-protocol [78797a];	text_list	N/A	Specifies a list of Uniform Resource Locators (URLs), each pointing to a user authentication service that is capable of processing authentication requests encapsulated in the UAP. UAP servers can accept either HTTP 1.1 or SSLv3 connections. If the list includes a URL that does not contain a port component, the normal default port is assumed (port 80 for http and port 443 for https). If the list includes a URL that does not contain a path component, the path /uap is assumed.
100	timezone-posix	option timezone-posix "xyz" ;	text	255	Specifies a DHCP client's timezone specified as a POSIX 1003.1 timezone string.
101	timezone-database	option timezone-database "xyz" ;	text	255	Specifies a DHCP client's timezone specified as a TZ database string.

Option Code	dhcpd.conf Key-word	dhcpd.conf example	Data type	Default Value	Description
116	ipv4-auto-configuration	option ipv4-auto-configuration false;	boolean	False	This option is used to check whether, and be notified if, autoconfiguration should be disabled on the local subnet. When a server responds with the value “AutoConfigure” (True), the client may generate a linklocal IP address if appropriate. However, if the server responds with “DoNotAutoConfigure” (False), the client must not generate a link-local IP address, possibly leaving it with no IP address.
119	domain-search	option domain-search [0378797a00];	text_list	N/A	Passes the domains in the search list from the DHCP Server to the DHCP Client to use when resolving hostnames using DNS.
120	sip-server	option sip-server [010a0a0064];	ip_address_list	N/A	Lists the SIP servers specified as IPV4
121	classless-static-route	option classless-static-route 16.10.10 10.10.0.200;	ip_mask_ip_list	N/A	Specifies one or more static routes, each of which consists of a destination descriptor (the subnet address and subnet mask) and the IP address of the router that should be used to reach that destination.
122	cablelabs-client-config	option cablelabs-client-config [01040a0a006402 040a0a0064040 c0000000a000000 0a0000000a050 c0000000a000000 0a0000000a060 50358595a000701 00080100]; option 177 [010378797a0203 78797a030378797 a040378797a0503 78797a060378797 a07010008010009 0378797a];	sub_option		The following table describes the CableLabs Client Configuration 122 sub-options, specified in RFC 3495:
123	TSP Primary DHCP Server Address		ip_address	N/A	Specifies the IP address of the TSP’s primary DHCP server from which an MTA is permitted to accept a DHCP OFFER.
124	TSP Secondary DHCP Server Address		ip_address	N/A	Specifies the IP address of the TSP’s secondary DHCP server from which an MTA is permitted to accept a DHCP OFFER.

Option Code	dhcpd.conf Key-word	dhcpd.conf example	Data type	Default Value	Description
125	TSP Provisioning Server Address			IP_address	MTAs communicate with the Provisioning server at various stages in their provisioning process. Enter either the IP address or the FQDN of the TSP's Provisioning server.
126	TSP ASREQ/AS-REP Backoff and Retry		sub-option	N/A	Configures an MTA's Kerberos ASREQ/AS-REP timeout, backoff, and retry mechanism. Enter a Nominal Timeout value in milliseconds, a Maximum Timeout value in seconds and a Maximum Retry value. All these values are unsigned.
127	TSP Kerberos Realm Name		text	N/A	The Packet Cable architecture requires an MTA to authenticate itself to the TSP's network through the Kerberos protocol. A Kerberos Realm name is required at the MTA to permit a DNS lookup for the address of the TSP's Kerberos Key Distribution Center (KDC) entity. Note: The realm name must be all capital letters and conform to domain name syntax (HOST.SUBDOMAIN.DOMAIN).
128	TSP Ticket Granting Server Utilization		boolean	False	Determines whether an MTA should use a Ticket Granting Ticket (TGT) when obtaining a service ticket for one of the PacketCable application servers. Select True to indicate that the MTA should get its TGT.
129	TSP Provisioning Timer		numeric	0	Defines the maximum time allowed for the MTA provisioning process to complete. If this timer expires before the MTA has completed the provisioning process, the MTA should reset the timer and re-start its provisioning process from the beginning. Enter a value from 0 to 255, where 0 means the timer is disabled.
130	ActiveLeaseExpiration	ActiveLeaseExpiration=On		On	Determines how expired leases are handled. The following values are available: Off - causes expired leases to not be actively deleted at expiration. Full_delete - causes the lease from DHCP database to be deleted.

Option Code	dhcpd.conf Key-word	dhcpd.conf example	Data type	Default Value	Description
131	CheckTransactionID	CheckTransactionID=True		False	This policy is used to configure the service to ignore multiple discover, request, and Bootp messages that have the same XID. Default lease duration in secs.
132	DefaultLease	DefaultLease=86400		7776000 (90 days)	Default lease duration in secs.
133	DropAllDhcpInformPackets	DropAllDhcpInformPackets=True		False	If you set this policy to True, the DHCP server precludes the processing of any DHCPINFORM packet, beyond the parsing of the incoming packet. This policy allows administrators to configure the DHCP server to ignore inform packets, when the processing of the same is not required.
134	DropZeroMacAddressPackets	DropZeroMacAddressPackets=False		True	When set to True, the server checks all incoming packets for a zero MAC address and drops the packet if found. Note: DHCPINFORM messages are processed regardless. Note: This option is not supported in AOS because Source Learning does not learn ZeroMac Address and packets will not reach the DHCP server at all as it will be dropped.
135	ForceClass	ForceClass=Vendor		None	Determines if the service verifies a client's request for a lease before issuing a lease. The values are as follows: None - allows the server to issue leases from any scope to any incoming client request. Both - forces the service to require a match for both user and vendor class against those defined for a particular scope. Vendor - causes the service to require a match on vendor class only. User - causes the service to require a match on user class only.
136	HonorRequestedLeaseTime	HonorRequestedLeaseTime=False		True	If this policy is True, the service honors requested lease times from the client. If set to False, the server offers the configured lease time.

Option Code	dhcpd.conf Key-word	dhcpd.conf example	Data type	Default Value	Description
137	LeaseExpirationSleepTime	LeaseExpirationSleepTime=120000		60000 msec	A specified time interval in msec at which lease expiration processing occurs. Note: This value cannot be less than 1 minute.
138	MaxPendingSeconds	MaxPendingSeconds=20		10	The number of seconds that an offered lease remains in a pending state. When the server responds to a client's DHCP Discover request with a DHCP Offer, the address is marked as pending. By default, the server waits 10 seconds for a DHCP Request for this address from the client before unmarking the address, and then making it available to offer to another client.
139	MaxUnavailableTime	MaxUnavailableTime=14000		86400	This policy determines the period of time that an IP address is considered unavailable following a DHCP DECLINE or ping before assign offer response. Beyond this time, the server considers this address as available.
140	NakUnknownClients	NakUnknownClients=False		True	This policy causes the server to NAK clients who request addresses that are not in the service's defined subnets. This policy should be set to False in environments where multiple DHCP services are servicing the same subnet(s) (not failover). When set to True, the service returns a NAK to these client requests, which causes the client to revert to INIT state. The client then obtains a lease from one of the configured scopes for the client's current subnet.
141	NackDhcpRequestsForDuplicates	NackDhcpRequestsForDuplicates=False		True	When set to True, sends a NAK if a RENEW/REBIND request or SELECTING request is received for an IP already owned by another hardware address. When set to False, the invalid request is merely dropped.
142	PingDelay	PingDelay=200		500	This value determines the amount of time in msec the DHCP Service waits for a response regarding the availability of an IP address. The positive response determines existence of IP address in the network already.

Option Code	dhcpd.conf Key-word	dhcpd.conf example	Data type	Default Value	Description
143	PingAttempts	PingAttempts=3		1	Number of attempts for ping before which DHCP Server determines the IP address is already in use or not.
144	PingSendDelay	PingSendDelay=100		0	The amount of msec between subsequent pings. Applicable only if the PingAttempts is greater than 1. When PingAttempts is greater than 1, the PingSendDelay will override the PingDelay policy.
145	PingRetention	PingRetention=20		0	This specifies amount of seconds a ping is "good for". If a ping is attempted and no response is returned, then the address is assumed available. If another request comes into the service that would cause it to attempt a ping on a previously pinged address, this ping does not take place if it is within defined seconds of the previous ping.
146	PingBeforeManualDhcp	PingBeforeManualDhcp=False		True	Perform a ping before assigning a Static DHCP address. If an ICMP_REPLY is received from the ping, no offer is sent to the client and the address is marked as unavailable.
147	PingBeforeManualBootp	PingBeforeManualBootp=True		False	Perform a ping before assigning a Static Bootp address. If an ICMP_REPLY is received from the ping, no Bootp reply is sent to the client, and the address is marked as unavailable.
148	RegisteredClientsOnly	RegisteredClientsOnly=True		False	This option is only used when MAC pool addresses are defined at either the global or the subnet level. If this value is set to False, the DHCP Service responds to clients with a MAC address that is unknown to the server. If this option is set to True when no MAC pool addresses are defined at either the global or the subnet level, no device will be given a DHCP lease

Option Code	dhcpd.conf Key-word	dhcpd.conf example	Data type	Default Value	Description
149	SendRequestedParamsOnly	SendRequestedParamsOnly=True		False	If set to True, this policy instructs the DHCP Service to send only the options requested by the client. If the client sends a DHCP parameter request list Option (55) in the Discover packet, then the service sends only the Options that are both configured and requested by the client. However, Options subnet-mask (1) and lease-time (51) are always sent to the client, in addition to the IP address. When False, the service sends all configured Options to the client.
150	SupportRelayAgentDeviceClasses	SupportRelayAgentDeviceClasses=True		False	When set to True, the server supports the assignment of DHCP options specifically by DOCSIS device class. Options are configured using the device class client class in VitalQIP, and will be assigned if the device class suboption of the relay agent option (option 82) matches the device class value specified in the client class. Set to True to enable the device class and make the Device Class Client Class useful.
151	ZeroCiAddr	ZeroCiAddr=True		False	This policy only affects the contents of the "ciaddr" field in outgoing packets. If this policy is set to True, the service fills in "ciaddr" with 0.0.0.0 on reply (ACK) packets.

Policy File Parameters and Syntax

Num	Policy	Usage	Default Value	Description
1	ActiveLease Expiration	ActiveLease Expiration = On	Off	<p>Determines how the expired leases are handled. The following values are available:</p> <p>Off - prevents expired leases from being automatically deleted after lease period is over.</p> <p>Full_delete - causes the lease from DHCP database to be deleted, and the Message Service to be notified of expired leases.</p>
2	Check TransactionID	Check Transaction ID=True	False	Configures the service to ignore multiple discover, request, and BootP messages that have the same XID.
3	DefaultLease	Default Lease=86400	7776000 (90 days)	Specifies the default lease period provided for the clients in seconds.
4	DropAll DhcpInform Packets	DropAll Dhcp Inform Packets = True	False	<p>Allows administrators to configure the DHCP server to ignore inform packets.</p> <p>If this policy is set to True, the DHCP server prevents the processing of DHCPINFORM packets. However, the incoming packets are parsed.</p>
4	DropZero MacAddress Packets	DropZero MacAddress Packets = False	True	<p>If this policy is set to True, the DHCP server checks all incoming packets for a zero MAC address and drops the packet if it is found.</p> <p>Note: DHCPINFORM messages are processed even if this process is set to true.</p>
5	ForceClass	ForceClass =VendorNone	True	<p>Determines if the service verifies the lease request from the client before issuing a lease.</p> <p>The values associated with this policy are as follows:</p> <ul style="list-style-type: none"> • None - Allows the server to issue leases from any IP address range to an incoming client request. • Both - Forces the service to match for both user and vendor class with the values defined for a particular IP address range. • Vendor - The service must match only on the vendor class. • User - The service must match only on user class.
6	Honor Requested LeaseTime	Honor Requested Lease Time = False	True	<p>If this policy is set to True, the DHCP server provides the requested lease time to the client.</p> <p>If this policy is set to False, the server offers the configured lease time.</p>

Num	Policy	Usage	Default Value	Description
7	Lease Expiration SleepTime	Lease Expiration SleepTime = 120000	60000 msec	Specifies the time interval in milli seconds after which the lease expiration processing occurs. Note: This value must not be less than 1 minute.
8	MaxPending Seconds	MaxPending Seconds = 20	10	Specifies the number of seconds that an offered lease remains in a pending state. When a client sends a DHCPDISCOVER request, the DHCP server responds with a DHCPOFFER and offers an IP address. The address is marked as pending for the specified period of time.
9	Max Unavailable Time	Max Unavailable Time = 14000	86400	Determines the period of time that an IP address is not available after a DHCPDECLINE or ping packet is sent as response. After this time period, the server considers this address as available.
10	Nak Unknown Clients	NakUnknown Clients = False	True	Prevents the DHCP server from providing DHCP addresses to clients which are not in the defined subnets of the DHCP server. This policy must be set to False in environments where multiple DHCP services are active in the same subnet or subnets.
11	NackDhcp RequestsFor Duplicates	NackDhcp RequestsFor Duplicates = False	True	If this value is set to True , the DHCP server sends a NAK if a RENEW/REBIND request or SELECTING request is received for an IP address already owned by another hardware interface. If this value is set to False , the invalid request is dropped.
12	PingAttempts	Ping Attempts = 3	1	Specifies the number of attempts to ping through which DHCP server determines if the IP address is already in use.
13	PingDelay	PingDelay = 200	N/A	Specifies the delay in milliseconds between two consecutive pings to check the IP address usage in the network.
14	PingSendDelay	PingSend Delay = 1000	500	Specifies the number of milliseconds between subsequent pings. This is applicable only if the ping attempts are greater than 1. If the value of PingAttempts is greater than 1, then the PingSendDelay overrides the PingDelay policy.
15	PingRetention	Ping Retention = 200	0	Specifies the number of seconds for which a ping is valid. If a ping is attempted and no response is returned, then the address is considered to be available. During the ping retention period, other ping requests are ignored.

Num	Policy	Usage	Default Value	Description
18	PingBeforeManualDhcp	PingBeforeManualDhcp = False	True	If this value is set to True , the DHCP server performs a ping before assigning a static DHCP address. If an ICMP_REPLY is received from the ping, then the DHCP offer is not sent to the client and the address is marked as unavailable.
19	PingBeforeManualBootp	PingBeforeManualBootp = True	False	If this value is set to True , the DHCP server performs a ping before assigning a static BootP address. If an ICMP_REPLY is received, the BootP reply is not sent to the client, and the BootP address is marked as unavailable.
20	RegisteredClientsOnly	RegisteredClientsOnly = True	False	This policy is used when the MAC pool addresses are defined at either the global or the subnet level. If this value is set to True , the DHCP information is provided to the clients that have a known MAC address (configured in a MAC pool). If MAC pool addresses are not defined at either the global or the subnet level, the none of the devices are provided a DHCP lease. If this value is set to False , the DHCP information is provided to all clients.
21	SendRequestedParamsOnly	SendRequestedParamsOnly = True	False	If this value is set to True , the DHCP server sends only the options requested by the client. For example, if the client sends a DHCP parameter request list - option (55) in the Discover packet, then the server sends only the options that are both configured and requested by the client. The subnet-mask (1) and lease-time (51) options are always sent to the client, in addition to the IP address. If this value is set to False , the service sends all the configured options to the client.
22	SupportRelayAgentDeviceClass	SupportRelayAgentDeviceClass = True	False	If this policy is set to True , the server supports the assignment of DHCP options by the DOCSIS device class.
23	ZeroCiAddr	ZeroCiAddr = True	False	This policy affects the contents of the "ciaddr" field in outgoing packets. If this policy is set to True , the service fills in "ciaddr" with 0.0.0.0 on reply (ACK) packets.

Num	Policy	Usage	Default Value	Description
24	DenyConnectionList	DenyConnectionList=IP addresses	None	This policy does not allow connections from listed IP addresses and networks. An example of listed IP addresses would be: DenyConnectionList=127.0.0.1,10.0.0.0/8. In this example, connections from the loopback address and the Class A 10 network are not allowed. If this policy is set to All , connections from all IP addresses and networks are not allowed. If AllowConnectionList and DenyConnectionList are set at the same time, AllowConnectionList takes precedence over the DenyConnectionList.
25	AllowConnectionList	AllowConnectionList=IP addresses	All	This policy allows connections from all listed IP addresses and networks. An example of listed IP addresses would be: AllowConnectionList=127.0.0.1,10.0.0.0/8. In this example, connections from the loopback address and the Class A 10 network are allowed. If this policy is set to All , connections from all IP addresses and networks are allowed. If AllowConnectionList and DenyConnectionList are set at the same time, AllowConnectionList takes precedence over the DenyConnectionList.
26	ListenPort	Any valid port number	Ephemeral	This policy specifies which port the service listens for messages. Ephemeral indicates that the service will use a port that is dynamically allocated by the operating system. It will register this port with the local message service. To accept messages from previous releases of VitalQIP, set this policy to the service name qip_ctl, or the port number 1096. Ports are usually less than 32,000.
27	ACKPeriod	Numeric	0	This policy specifies how often an ACK will be expected when leases are transmitted to the GUI. By default, only the last packet is ACKed.

24 Configuring VRRP

The Virtual Router Redundancy Protocol (VRRPv2/VRRPv3) is a standard router redundancy protocol supported in IPv4/IPv6, based on RFC 3768 and RFC 2787. It provides redundancy by eliminating the single point of failure inherent in a default route environment. The VRRPv2/VRRPv3 router, which controls the IPv4/IPv6 address associated with a virtual router is called the master router, and is responsible for forwarding virtual router advertisements. If the master router becomes unavailable, the highest priority backup router will transition to the master state. The Alcatel-Lucent implementation of VRRP also supports the collective management of virtual routers on a switch.

Notes.

- This VRRPv3 implementation is based on the latest Internet Draft, Virtual Router Redundancy Protocol for IPv6, September 2004.
 - RFC 3768, which obsoletes RFC 2338, does not include support for authentication types. As a result, configuring VRRP authentication is no longer supported in this release.
-

In This Chapter

This chapter describes VRRPv2/VRRPv3 and how to configure it through the Command Line Interface (CLI). CLI commands are used in the configuration examples; for more details about the syntax of commands, see the *OmniSwitch AOS Release 8 CLI Reference Guide*.

This chapter provides an overview of VRRP and includes information about the following:

- [“Creating/Deleting a Virtual Router” on page 24-10.](#)
- [“Specifying an IP Address for a Virtual Router” on page 24-11.](#)
- [“Configuring the Advertisement Interval” on page 24-12.](#)
- [“Configuring Virtual Router Priority” on page 24-12.](#)
- [“Setting Preemption for Virtual Routers” on page 24-13.](#)
- [“Setting VRRP Traps” on page 24-14.](#)
- [“Configuring Collective Management Functionality” on page 24-14](#)
- [“Verifying the VRRP Configuration” on page 24-18.](#)
- [“VRRPv3 Configuration Overview” on page 24-19.](#)
- [“Specifying an IPv6 Address for a VRRPv3 Virtual Router” on page 24-20.](#)
- [“Configuring the VRRPv3 Advertisement Interval” on page 24-21.](#)
- [“Configuring the VRRPv3 Advertisement Interval” on page 24-21.](#)

- “Configuring the VRRPv3 Virtual Router Priority” on page 24-21.
- “Setting Preemption for VRRPv3 Virtual Routers” on page 24-22.
- “Setting VRRPv3 Traps” on page 24-23.
- “Creating Tracking Policies” on page 24-25.
- “Creating Tracking Policies” on page 24-25.
- “Verifying the VRRPv3 Configuration” on page 24-24.

VRRP Specifications

Platforms Supported	OmniSwitch 6860, 6860E
RFCs Supported	RFC 3768–Virtual Router Redundancy Protocol RFC 2787–Definitions of Managed Objects for the Virtual Router Redundancy Protocol
Compatible with HSRP	No
Maximum number of VRRPv2 and VRRPv3 virtual routers	255
Maximum number of IP addresses per instance	16

VRRP Defaults

The following table lists the defaults for VRRP configuration through the **vrrp** command and the relevant command keywords:

Description	Keyword	Default
Virtual router enabled or disabled	enable disable	Virtual routers are disabled
Priority	priority	100
Preempt mode	preempt no preempt	Preempt mode is enabled
Advertising interval	advertising interval	1 second (100 centiseconds)

The following table lists the defaults for VRRP configuration using the VRRP collective management features and the relevant command:

Default advertising interval for all the virtual routers on the switch.	vrrp interval	1 second (100 centiseconds)
Default priority value for all the virtual routers on the switch.	vrrp priority	100
Default preempt mode for all the virtual routers on the switch.	vrrp preempt	preempt
Parameter value that is to be set and/or override with the new default value in all the virtual routers on the switch.	vrrp set	all
Default advertising interval for all the virtual routers in the group.	vrrp group	1
Default priority value for all the virtual routers in the group.	vrrp group	100

Default preempt mode for all the virtual routers in the group.	vrrp group	preempt
--	-------------------	----------------

Parameter value that is to be set and/or override with the new default value in all the virtual routers in the group.	vrrp group set	all
---	-----------------------	------------

In addition, other defaults for VRRP include:

Description	Command	Default
VRRP traps	vrrp trap	Enabled
VRRP delay	vrrp delay	45 seconds

Quick Steps for Creating a Virtual Router

- 1 Create a virtual router. Specify a virtual router ID (VRID) and a VLAN ID. For example:

```
-> vrrp 6 4
```

The VLAN must already be created on the switch. For information about creating VLANs, see [Chapter 4, “Configuring VLANs.”](#)

- 2 Configure an IP address for the virtual router.

```
-> vrrp 6 4 address 10.10.2.3
```

Note. IP can be used as an optional parameter instead of **Address** in the above example.

- 3 Repeat steps 1 through 2 on all of the physical switches that will participate in backing up the address(es) associated with the virtual router.

- 4 Enable VRRP on each switch.

```
-> vrrp 6 4 admin-state enable
```

Note. *Optional.* To verify the VRRP configuration, enter the [show vrrp](#) command. The display is similar to the one shown here:

```
VRRP trap generation: Enabled
VRRP startup delay: 45 (expired)
      IP      Admin
VRID  VLAN  Address(es)  Status      Priority  Preempt  Interval
-----+-----+-----+-----+-----+-----+-----
6     4     10.10.2.3   Enabled     100      yes      1
```

Note. For more information about this display, see the *OmniSwitch AOS Release 8 CLI Reference Guide*.

VRRP Overview

VRRP allows the routers on a LAN to backup a default route. VRRP dynamically assigns responsibility for a virtual router to a physical router (VRRP router) on the LAN. The virtual router is associated with an IP address (or set of IP addresses) on the LAN. A virtual router master is elected to forward packets for the virtual router's IP address. If the master router becomes unavailable, the highest priority backup router will transition to the master state.

Note. The IP address that is backed up may be the IP address of a physical router, or it may be a virtual IP address.

The example provided here is intended for understanding VRRP and does not show a configuration that would be used in an actual network.

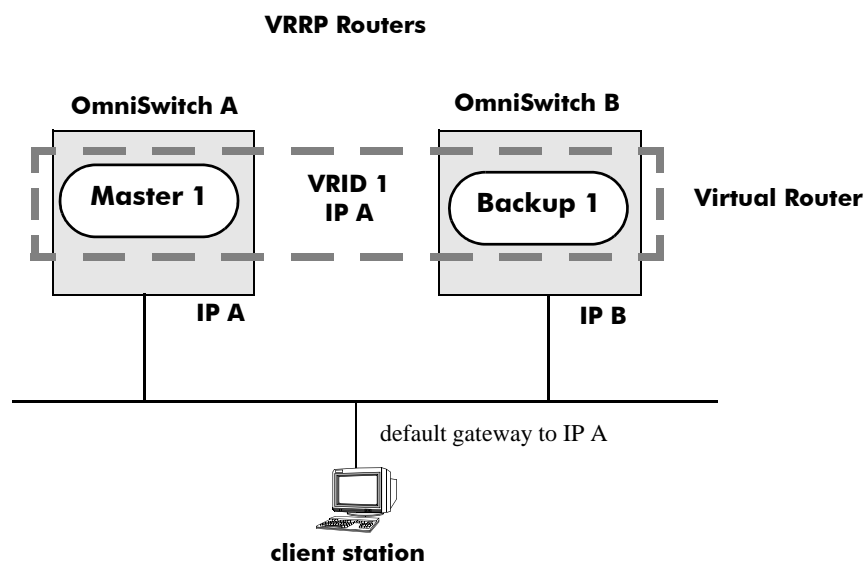

VRRP Redundancy Example

In this example, each physical router is configured with a virtual router, VRID 1 which is associated with IP address A. OmniSwitch A is the master router because it contains the physical interface to which IP address A is assigned. OmniSwitch B is the backup router. The client is configured with a gateway address of IP A.

When VRRP is configured on these switches, and both the switches are available, OmniSwitch A will respond to ARP requests for IP address A using the virtual router's MAC address (00:00:5E:00:01:01) instead of the physical MAC address assigned to the interface. OmniSwitch A will accept packets sent to the virtual MAC address and forward them as appropriate; it will also accept packets addressed to IP address A (such as ping requests).

Note. A ping request to the VRRP IP will not be replied to if the request is from the local CMM which is also acting as the VRRP Master. Only ping requests that originate from external routers will be replied to.

OmniSwitch B will respond to ARP requests for IP address B using the interface's physical MAC address. It will not respond to ARP requests for IP address A or to the virtual router MAC address.

If OmniSwitch A becomes unavailable, OmniSwitch B becomes the master router. OmniSwitch B will then respond to ARP requests for IP address A using the virtual router's MAC address (00:00:5E:00:01:01). It will also forward packets for IP address B and respond to ARP requests for IP address B using the OmniSwitch's physical MAC address.

OmniSwitch B uses IP address B to access the LAN. However, IP address B is not backed up. Therefore, when OmniSwitch B becomes unavailable, IP address B also becomes unavailable.

Why Use VRRP?

An end host may use dynamic routing or router discovery protocols to determine its first hop toward a particular IP destination. With dynamic routing, large timer values are required and may cause significant delay in the detection of a dead neighbor.

If an end host uses a static route to its default gateway, this creates a single point of failure if the route becomes unavailable. End hosts will not be able to detect alternate paths.

In either case, VRRP ensures that an alternate path is always available.

Definition of a Virtual Router

To backup an IP address or addresses using VRRP, a virtual router must be configured on VRRP routers on a common LAN. A VRRP router is a physical router running VRRP. A virtual router is defined by a virtual router identifier (VRID) and a set of associated IP addresses on the LAN.

Note. A single VRID may be associated with a VLAN.

Each VRRP router may backup one or more virtual routers. The VRRP router containing the physical interfaces to which the virtual router IP addresses are assigned is called the *IP address owner*. If it is available, the IP address owner will function as the master router. The master router assumes the responsibility of forwarding packets sent to the IP addresses associated with the virtual router and answering ARP requests for these addresses.

To minimize network traffic, only the master router sends VRRP advertisements on the LAN. The IP address assigned to the physical interface on the current master router is used as the source address in VRRP advertisements. The advertisements communicate the priority and state of the master router associated with the VRID to all VRRP routers. The advertisements are IP multicast datagrams sent to the VRRP multicast address 224.0.0.18 (as determined by the Internet Assigned Numbers Authority).

If a master router becomes unavailable, it stops sending VRRP advertisements on the LAN. The backup routers know that the master is unavailable based on the following algorithm:

$$\text{Master Down Interval} = (3 * \text{Advertisement Interval}) + \text{Skew Time}$$

where *Advertisement Interval* is the time interval between VRRP advertisements, and *Skew Time* is calculated based on the VRRP router's priority value as follows:

$$\text{Skew Time} = (256 - \text{Priority}) / 256$$

If the backup routers are configured with priority values that are close in value, there may be a timing conflict, and the first backup to take over may not be the one with the highest priority; and a backup with a higher priority will then preempt the new master. The virtual router may be configured to prohibit any preemption attempts, except by the IP address owner. An IP address owner, if it is available, will always become master of any virtual router associated with its IP addresses.

Note. Duplicate IP address/MAC address messages may display when a backup takes over for a master, depending on the timing of the takeover and the configured advertisement interval. This is particularly true if more than one backup is configured.

VRRP MAC Addresses

Each virtual router has a single well-known MAC address, which is used as the source in all periodic VRRP advertisements sent by the master router, as the MAC address in ARP replies sent by VRRPv2, and as the MAC address in neighbor advertisements sent by VRRPv3 (instead of the MAC address for the physical VRRP router).

The VRRPv2 (IPv4) address has the following format:

00-00-5E-00-01-[virtual router ID]

The VRRPv3 (IPv6) address has the following format:

00-00-5E-00-01-[virtual router ID]

Note. By default, in AOS Release 8.1.1, packets that originate from a switch with an address assigned to a VRRPv3 virtual router will use the physical MAC as their source, not the VRRP virtual MAC. The **ipv6 virtual-source-mac** command can be used to modify this behavior resulting in the VRRP virtual MAC being used as the source. This command has no effect on VRRP advertisements, which will always be sent using the VRRP virtual MAC as the source.

Note. In AOS Release 8.1.1, packets that originate from a switch with an address assigned to a VRRPv3 virtual router will always use the VRRP virtual MAC.

ARP Requests

Each virtual router has a single well-known MAC address, which is used as the MAC address in ARP instead of a VRRP router's physical MAC address. When an end host sends an ARP request to the master router's IP address, the master router responds to the ARP request using the virtual router MAC address. If a backup router takes over for the master, and an end host sends an ARP request, the backup will reply to the request using the virtual router MAC address.

Gratuitous ARP requests for the virtual router IP address or MAC address are broadcast when the OmniSwitch becomes the master router. For VRRP interfaces, gratuitous ARP requests are delayed at system boot until both the IP address and the virtual router MAC address are configured.

If an interface IP address is shared by a virtual router, the routing mechanism does not send a gratuitous ARP for the IP address (since the virtual router will send a gratuitous ARP). This prevents traffic from being forwarded to the router before the routing tables are stabilized.

ICMP Redirects

ICMP redirects are not sent out over VRRP interfaces.

VRRP Startup Delay

When a virtual router reboots and becomes master, it becomes master before its routing tables are populated. This could result in loss of connectivity to the router. To prevent the loss in connectivity, a delay is used to prevent the router from becoming master before the routing tables are stabilized.

The default startup delay value can be modified to allow more or less time for the router to stabilize its routing tables.

In addition to the startup delay, the switch has an ARP delay (which is not configurable).

VRRP Tracking

A virtual router priority can be conditionally modified to prevent another router from taking over as master. Tracking policies are used to conditionally modify the priority setting whenever a port, IP address and or IP interface associated with a virtual router goes down.

A tracking policy consists of a tracking ID, the value used to decrease the priority value, and the port number, IP address, or IP interface name to be monitored by the policy. The policy is then associated with one or more virtual routers.

Configuring Collective Management Functionality

This feature provides user with the flexibility to manage the virtual routers on the switch collectively and also the capability to group the virtual routers to a virtual router group which simplifies the configuration and management tasks.

You can change the default values of the parameters like advertising interval, priority, preempt mode and the administrative status of all the virtual routers on a switch or in a virtual router group using this collective management functionality feature. For more information about configuring collective management functionality, see [page 24-14](#).

Note. VRRP3 does not support the collective management functionality in this release.

Interaction With Other Features

- IP routing—IP routing must be enabled for the VRRP configuration to take effect.
- Router Discovery Protocol (RDP)—If RDP is enabled on the switch, and VRRP is enabled, RDP will advertise VLAN IP addresses of virtual routers depending on whether there are virtual routers active on the LAN, and whether those routers are backups or masters. When there are no virtual routers active on the VLAN (either acting as master or backup), RDP will advertise all VLAN IP addresses. However, if virtual routers are active, RDP will advertise IP addresses for any master routers; RDP will not advertise IP addresses for backup routers.

VRRP Configuration Overview

During startup, VRRP is loaded onto the switch and is enabled. Virtual routers must be configured and enabled as described in the following sections. Since VRRP is implemented on multiple switches in the network, some VRRP parameters must be identical across switches:

- **VRRP and ACLs**

If QoS filtering rules (Access Control Lists) are configured for Layer 3 traffic on a VRRP router, all of the VRRP routers on the LAN must be configured with the same filtering rules; otherwise the security of the network is compromised. For more information about filtering, see [Chapter 27, “Configuring QoS.”](#)

- **Conflicting VRRP Parameters Across Switches**

All virtual routers with the same VRID on the LAN must be configured with the same advertisement interval and IP addresses. If the virtual routers are configured differently, it may result in more than one virtual router acting as the master router. This in turn would result in duplicate IP and MAC address messages as well as multiple routers forwarding duplicate packets to the virtual router MAC address. Use the [show vrrp statistics](#) command to check for conflicting parameters. For information about configuring VRRP parameters, see the remaining sections of this chapter.

Basic Virtual Router Configuration

At least two virtual routers must be configured on the LAN—a master router and a backup router. The virtual router is identified by a number called the Virtual Router ID (VRID), the VLAN on which the virtual router is configured, and the IP address or addresses associated with the router. Multiple virtual routers may be configured on a single physical VRRP router.

Basic commands for setting up virtual routers include:

```
vrrp
vrrp address
```

The next sections describe how to use these commands.

Creating/Deleting a Virtual Router

To create a virtual router, enter the [vrrp](#) command with the desired VRID and the relevant VLAN ID. The VRID must be a unique number in the range from 1 to 255. The VLAN must already be created on the switch through the [vlan](#) command. For information about creating VLANs, see [Chapter 4, “Configuring VLANs.”](#) For example:

```
-> vrrp 6 4
```

This command creates VRID 6 on VLAN 4.

When you create a new virtual router, the VRID ID and a VLAN ID are *required*. Optionally, you may also specify:

- **Priority (vrrp priority)**: use the **priority** keyword to change the default priority value and set a desired value. Note that the IP address owner is automatically assigned a value of 255, which overrides any value that you may have already configured. See [“Configuring Virtual Router Priority” on page 24-12](#) for more information about how priority is used.

- **Preempt mode (vrrp preempt):** To change from the default preempt mode and to turn it off, use **no preempt**. Use **preempt** to turn it back on. For more information about the preempt mode, see “[Setting Preemption for Virtual Routers](#)” on page 24-13.
- **Advertising interval (vrrp interval):** Measured in seconds. Use the **interval** keyword with the desired number of seconds for the delay in sending VRRP advertisement packets. You can change the default interval value and set a desired value. See “[Configuring the Advertisement Interval](#)” on page 24-12.

The following example creates a virtual router (with VRID 7) on VLAN 2 with a priority of 75. The preempt mode of the router is enabled and VRRP advertisements will be sent at intervals of 2 seconds:

```
-> vrrp 7 2 priority 75 preempt interval 2
```

Note. All virtual routers with the same VRID on the same LAN must be configured with the same advertising interval; otherwise the network may produce duplicate IP or MAC address messages.

The **vrrp** command may also be used to specify whether the virtual router is enabled or disabled. *However, the virtual router must have an IP address assigned to it before it can be enabled.* Use the **vrrp address** command as described in the next section to specify an IP address or addresses.

To delete a virtual router, use the **no** form of the **vrrp** command with the relevant VRID and VLAN ID. For example:

```
-> no vrrp 7 3
```

Virtual router 7 on VLAN 3 is deleted from the configuration. (The virtual router does not have to be disabled before you delete it.)

For more information about the **vrrp** command syntax, see the *OmniSwitch AOS Release 8 CLI Reference Guide*.

Specifying an IP Address for a Virtual Router

An IP address must be specified before a virtual router may be enabled. To specify an IP address for a virtual router, use the **vrrp address** command and the relevant IP address. For example:

```
-> vrrp 6 4 address 10.10.2.3  
-> vrrp 6 4 admin-state enable
```

In this example, the **vrrp address** command specifies that virtual router 6 on VLAN 4 will be used to backup IP address 10.10.2.3. The virtual router is then enabled with the **vrrp** command.

Note that if a virtual router is to be the IP address owner, then all addresses on the virtual router must match an address on the switch interface.

To remove an IP address from a virtual router, use the **no** form of the **vrrp address** command. For example:

```
-> vrrp 6 4 admin-state disable  
-> vrrp 6 4 no address 10.10.2.3
```

In this example, virtual router 6 is disabled. (A virtual router must be disabled before IP addresses may be added/removed from the router.) IP address 10.10.2.3 is then removed from the virtual router with the **no** form of the **vrrp address** command.

Configuring the Advertisement Interval

The advertisement interval is configurable, but all virtual routers with the same VRID must be configured with the same value. If the advertisement interval is set differently for a master router and a backup router, VRRP packets may be dropped because the newly configured interval does not match the interval indicated in the packet. The backup router will then take over and send a gratuitous ARP, which includes the virtual router IP address and the virtual router MAC address. In addition to creating duplicate IP/MAC address messages, both routers will begin forwarding packets sent to the virtual router MAC address. This will result in forwarding duplicate packets.

To avoid duplicate addresses and packets, make sure the advertisement interval is configured the same on both the master and the backup router.

For more information about VRRP and ARP requests, see [“ARP Requests” on page 24-8](#).

To configure the advertisement interval, use the **vrrp** command with the **interval** keyword (**vrrp interval**). For example:

```
-> vrrp 6 4 admin-state disable
-> vrrp 6 4 interval 5
```

In this example, virtual router 6 is disabled. (If you are modifying an existing virtual router, the virtual router must be disabled before it may be modified.) The **vrrp** command is then used to set the advertising interval for virtual router 6 to 5 seconds. Optionally, you can also preface the **advertising** keyword before **interval**.

Configuring Virtual Router Priority

VRRP functions with one master virtual router and at least one backup virtual router. A priority value determines the role each router plays. It also decides the selection of backup routers for taking over as the master router, if the master router is unavailable.

Priority values range from 1 to 255. If a VRRP router owns the IP address of the virtual router and the IP address of the physical interface, this router will function as a virtual router master and its priority value will be 255. The value cannot be set to 255 if the router is not the IP address owner.

If there is more than one backup router, it is necessary to configure their priorities with different values. This is done so to elect the backup router with the highest value as the master. If the priority values are the same, the backup virtual router with the highest physical interface IP address is chosen as the master.

To set the priority, use the **vrrp** command with the **priority** keyword and the desired value (**vrrp priority**). For example:

```
-> vrrp 6 4 admin-state disable
-> vrrp 6 4 priority 50
```

In this example, virtual router 6 is disabled. (If you are modifying an existing virtual router, it must be disabled before it is modified.) The virtual router priority is then set to 50. Setting the value to 50 provides the router with a lower priority in the VRRP network.

Setting Preemption for Virtual Routers

When a master virtual router becomes unavailable (goes down for whatever reason), a backup router will take over. When there is more than one backup router and if their priority values are very nearly equal, the skew time may not be sufficient to overcome delays caused by network traffic loads. This may cause a lower priority backup to assume control before a higher priority backup. But when the preempt mode is enabled, the higher priority backup router will detect this and assume control.

Note. In certain cases, this may not be a desirable behavior, as when the original master comes back and immediately causes all the traffic to switch back to it.

If all virtual routers have the preempt mode enabled, the virtual router with the highest priority will become the master. If the master router goes down, the highest priority backup router will become the master. If the previous master or any other virtual router comes up with the preempt mode enabled and has a higher priority value, this router will become the new master.

To prevent a router with a higher priority value from automatically taking control from a master router with a lower priority value, disable the preempt mode for the higher priority router. This is done by using the **no preempt** keywords with the **vrrp** command (**vrrp preempt**). For example:

```
-> vrrp 6 4 admin-state disable
-> vrrp 6 4 no preempt
```

Note. The virtual router that owns the IP address(es) associated with the physical router always becomes the master router if it is available, regardless of the preempt mode setting and the priority values of the backup routers.

In the above example, the first command administratively disables virtual router 6. (If you are modifying an existing virtual router, it must be disabled before it is modified.). The second command disables the preempt mode for the same router. Henceforth, router 6 will not preempt another virtual router with a lower priority. For more information see [“Configuring Virtual Router Priority” on page 24-12](#).

Enabling/Disabling a Virtual Router

To enable a virtual router, use the **vrrp** command with the **enable** keyword. Note that at least one IP address must be configured for the virtual router through the **vrrp address** command. For example:

```
-> vrrp 7 3 priority 150
-> vrrp 7 3 address 10.10.2.3
-> vrrp 7 3 admin-state enable
```

In this example, a virtual router is created on VLAN 3 with a VRID of 7. An IP address is then assigned to the virtual router. The virtual router is then enabled on the switch.

To disable a virtual router, use the **disable** keyword.

```
-> vrrp 7 3 admin-state disable
```

A virtual router must be disabled before it may be modified. Use the **vrrp** command to disable the virtual router first; then use the command again to modify the parameters. For example:

```
-> vrrp 7 3 admin-state disable
-> vrrp 7 3 priority 200
-> vrrp 7 3 admin-state enable
```

In this example, virtual router 7 on VLAN 3 is disabled. The virtual router is then modified to change its priority setting. (For information about configuring the priority setting, see [“Configuring Virtual Router Priority” on page 24-12.](#)) The virtual router is then re-enabled and will be active on the switch.

Setting VRRP Traps

A VRRP router has the capability to generate VRRP SNMP traps for events defined in the VRRP SNMP MIB.

In order for VRRP traps to be generated correctly, traps in general must be enabled on the switch through the SNMP CLI. See the *OmniSwitch AOS Release 8 Switch Management Guide* for more information about enabling SNMP traps globally.

To disable VRRP traps, use the **no** form of the **vrrp trap** command.

```
-> no vrrp trap
```

To re-enable traps, enter the **vrrp trap** command.

```
-> vrrp trap
```

Setting VRRP Startup Delay

After a switch reboot, the delay which is a global value takes effect and all virtual routers remain in the **initialize** state. They will remain in this state until the timer expires, at which point they will negotiate to determine whether to become the master or a backup.

To set a delay to all the virtual routers from going active before their routing tables are set up, use the **vrrp delay** command. This command applies only when the switch reboots.

```
-> vrrp delay 75
```

The switch now waits 75 seconds after its reboot before it becomes available to take over as master for another router.

Note. This command applies only when the switch reboots.

Configuring Collective Management Functionality

Collective management simplifies the management and configuration tasks of either all the virtual routers on the switch or only the virtual routers in a particular virtual router group.

The following section describes the above mentioned collective management functionality in detail:

Changing Default Parameter Values for all Virtual Routers

You can change the default advertising interval value of all the virtual routers on a switch using the **vrrp interval** command. For example:

```
-> vrrp interval 50
```

You can change the default priority value of all the virtual routers on a switch using the **vrrp priority** command. For example:

```
-> vrrp priority 50
```

You can change the default preempt mode of all the virtual routers on a switch using the **vrrp preempt** command. For example:

```
-> vrrp no preempt
```

These commands will set the new default values only for the virtual routers that are newly created. However, you can apply the new default value to the existing virtual routers. To apply the new default value to the existing virtual routers; you must first disable the virtual routers, then apply the new default value using the **vrrp set** command and enable the virtual routers again.

For example, to change the default priority value to 50 on all the existing virtual routers on a switch, enter the following:

```
-> vrrp priority 50
-> vrrp admin-state disable
-> vrrp set priority
-> vrrp admin-state enable
```

The first command configures the default priority value as 50 for all the virtual routers on the switch. The next command disables all the virtual routers on the switch. The **vrrp set** command in this sequence applies the new default priority value to the existing virtual routers. This value will be applied only to the virtual routers that already have the default value and not the values configured either individually or through group. This is because the configured values take priority over the default values.

For the modified default values to effect the virtual routers which are configured with a value either individually or through group, you can use the **vrrp set** command along with the **override** option. For example:

```
-> vrrp set priority override
```

Note. You can specify a parameter such as interval, priority, preempt or all in the **vrrp set** command to set and/or override the existing value with the new default values. The **all** option resets and/or overrides the existing advertising interval value, priority value and preempt mode with the modified default values.

The next command enables all the virtual routers on the switch except the virtual routers that are disabled individually or through group. To enable all the virtual routers on the switch including those which are disabled individually or through group, you can use the **vrrp** command along with the **enable-all** option as follows:

```
-> vrrp admin-state enable-all
```

Note. This collective virtual routers management functionality will not affect the ability to change the administrative status and parameter values of an individual virtual router.

Changing Default Parameter Values for a Virtual Router Group

The virtual routers can also be grouped under a virtual router group as another way of simplifying the configuration and management tasks.

A virtual router group can be created using the **vrrp group** command as follows:

```
-> vrrp group 25
```

This command creates a virtual router group 25. Use the **no** form of the same command to delete a virtual router group. For example:

```
-> no vrrp group 25
```

Note. When a virtual router group is deleted, the virtual routers assigned to the group become unassigned. However, this does not have any impact on the virtual routers.

After creating a virtual router group, you have to add virtual routers to the group using the **vrrp group-association** command, as follows:

```
-> vrrp 10 1 group-association 25
```

The above command adds the virtual router 10 on VLAN 1 to the virtual router group 25. A virtual router need not be disabled in order to be added to a virtual router group. However, the virtual router will not adopt the group's default parameter values until those values are applied by re-enabling the virtual router.

To remove a virtual router from a virtual router group, use the **no** form of the same command as follows:

```
-> vrrp 10 1 no group-association 25
```

Note that a virtual router need not to be disabled to be removed from a group.

You can change the default values of the parameters like advertising interval, priority and preempt of all the virtual routers in a virtual router group using the **vrrp group** command, as follows:

```
-> vrrp group 25 advertising interval 50 priority 50 no preempt
```

The above command configures the default value for advertising interval as 50 seconds, priority as 150 and preempting mode as **no preempt**. These parameters can be modified at any time but will not have any effect on the virtual routers in the group until you disable, then apply the group default value using the **vrrp group set** command and enable the virtual router group again.

For the modified default values to be applied to the virtual routers in a group, you must disable the virtual router group, then apply the group default value using the **vrrp group set** command and enable the virtual router group again. For example:

```
-> vrrp group 25 interval 50
-> vrrp group 25 admin-state disable
-> vrrp group 25 set interval
-> vrrp group 25 admin-state enable
```

The first command configures the default interval value as 50 for all the virtual routers in the virtual router group 25. The next command disables all the virtual routers in the group. **The vrrp group set** command in this sequence applies the new default interval value to all the virtual routers in the group. This value will be applied only to the virtual routers in the group that already have the default value and not the values configured individually. This is because the configured values take priority over the default values.

For the modified default values to affect the virtual routers in the group, including the virtual routers that are configured with a value individually, you can use the **vrrp group set** command along with the **override** option. For example:

```
-> vrrp group set interval override
```

Note. You can specify a parameter such as interval, priority, preempt or all in the **vrrp group set** command to set and/or override the existing value with the new default values. The **all** option resets and/or overrides the existing advertising interval value, priority value and preempt mode with the modified default values.

The next command enables all the virtual routers in the group except the virtual routers that are disabled individually. To enable all the virtual routers in the group including those which are disabled individually, you can use the **vrrp group** command with the **enable-all** option as follows:

```
-> vrrp group 25 admin-state enable-all
```

Note. Even though a virtual router may be assigned to a group, its parameter values and administrative status can still be modified individually.

Verifying the VRRP Configuration

A summary of the **show** commands used for verifying the VRRP configuration is given here:

show vrrp	Displays the virtual router configuration for all virtual routers or for a particular virtual router.
show vrrp statistics	Displays statistics about VRRP packets for all virtual routers configured on the switch or for a particular virtual router.
show vrrp track	Displays information about tracking policies on the switch.
show vrrp track-association	Displays the tracking policies associated with virtual routers.
show vrrp group	Displays the default parameter values for all the virtual router groups or for a specific virtual router group.
show vrrp group-association	Displays the virtual routers that are associated with a group.

For more information about the displays that result from these commands, see the *OmniSwitch AOS Release 8 CLI Reference Guide*.

VRRPv3 Configuration Overview

During startup, VRRPv3 is loaded onto the switch and is enabled. Virtual routers must be configured first and enabled as described in the sections. Since VRRPv3 is implemented on multiple switches in the network, some VRRPv3 parameters must be identical across switches:

- **VRRPv3 and ACLs**

If QoS filtering rules (Access Control Lists) are configured for Layer 3 traffic on a VRRP router, all of the VRRP routers on the LAN must be configured with the same filtering rules; otherwise the security of the network will be compromised. For more information about filtering, see [Chapter 27, “Configuring QoS.”](#)

- **Conflicting VRRPv3 Parameters Across Switches**

All virtual routers with the same VRID on the LAN must be configured with the same advertisement interval and IP addresses. If the virtual routers are configured differently, it may result in more than one virtual router acting as the master router. This in turn would result in duplicate IP and MAC address messages as well as multiple routers forwarding duplicate packets to the virtual router MAC address. Use the [show vrrp statistics](#) command to check for conflicting parameters. For information about configuring VRRPv3 parameters, see the remaining sections of this chapter.

Basic VRRPv3 Virtual Router Configuration

At least two VRRPv3 virtual routers must be configured on the LAN—a master router and a backup router. The VRRPv3 virtual router is identified by a number called the Virtual Router ID (VRID), the VLAN on which the VRRPv3 virtual router is configured, and the IPv6 address or addresses associated with the router. Multiple VRRPv3 virtual routers may be configured on a single physical VRRP router.

Basic commands for setting up VRRPv3 virtual routers include:

```
vrrp3  
vrrp3 address
```

The next sections describe how to use these commands.

Creating/Deleting a VRRPv3 Virtual Router

To create a VRRPv3 virtual router, enter the [vrrp3](#) command with the desired VRID and the relevant VLAN ID. The VRID must be a unique number in the range from 1 to 255. The VLAN must already be created on the switch through the [vlan](#) command. For information about creating VLANs, see [Chapter 4, “Configuring VLANs.”](#) For example:

```
-> vrrp3 6 4
```

This command creates VRID 6 on VLAN 4.

When you create a new VRRPv3 virtual router, the VRID ID and a VLAN ID are *required*. Optionally, you may also specify:

- **Priority ([vrrp priority](#))**: use the **priority** keyword to change the default priority value and set a desired value. Note that the IP address owner is automatically assigned a value of 255, which overrides any value that you may have already configured. See [“Configuring the VRRPv3 Virtual Router Priority” on page 24-21](#) for more information about how priority is used.

- **Preempt mode (vrrp preempt):** To change from the default preempt mode and to turn it off, use **no preempt**. Use **preempt** to turn it back on. For more information about the preempt mode, see [“Setting Preemption for VRRPv3 Virtual Routers”](#) on page 24-22.
- **Accept mode:** The accept mode allows the master router to accept packets addressed to the IPv6 address owner as its own. Use the **no accept** mode to prevent the master router from accepting packets addressed to the IPv6 address owner.
- **Advertising interval (vrrp interval):** Measured in seconds. Use the **interval** keyword with the desired number of centiseconds for the delay in sending VRRPv3 advertisement packets. You can change the default interval value and set a desired value. See [“Configuring the VRRPv3 Advertisement Interval”](#) on page 24-21.

Notes.

- The maximum number of virtual routers supported is based on the 100 centisecond interval. A smaller interval will result in a relatively lesser number of virtual routers.
- The centisecond interval cannot be less than 10 centiseconds.

The following example creates a VRRPv3 virtual router (with VRID 7) on VLAN 2 with a priority of 75, and no preempt. VRRPv3 advertisements will be sent at intervals of 200 centiseconds:

```
-> vrrp3 7 2 priority 75 no preempt interval 200
```

Note. All VRRPv3 virtual routers with the same VRID on the same LAN must be configured with the same advertisement interval; otherwise the network may produce duplicate IPv6 or MAC address messages.

The **vrrp3** command may also be used to specify whether the VRRPv3 virtual router is enabled or disabled. For more information about the **vrrp3** command syntax, see the *OmniSwitch AOS Release 8 CLI Reference Guide*.

To delete a VRRPv3 virtual router, use the **no** form of the **vrrp3** command with the relevant VRID and VLAN ID. For example:

```
-> no vrrp3 7 3
```

VRRPv3 virtual router 7 on VLAN 3 is deleted from the configuration. (The virtual router does not have to be disabled before you delete it.)

Specifying an IPv6 Address for a VRRPv3 Virtual Router

A VRRPv3 virtual router must have a link local address. By default, the virtual router link local address is created based on the virtual router MAC address and it does not need to be configured. Additional IPv6 addresses can be configured for a virtual router and these addresses must be within the subnet of an address configured on the interface. To specify an IPv6 address for a VRRPv3 virtual router, use the **vrrp3 address** command and the relevant IPv6 address. For example:

```
-> vrrp3 6 4 address fe80::200:5eff:fe00:20a
-> vrrp3 6 4 admin-state enable
```

In the above example, the **vrrp3 address** command specifies that VRRPv3 virtual router 6 on VLAN 4 will be used to backup IPv6 address `fe80::200:5eff:fe00:20a`. The virtual router is then enabled with the **vrrp3** command.

If a virtual router is to be the IP address owner, then all addresses on the virtual router must match an address on the switch interface. This includes the virtual router's link local address. In other words, a virtual router can not be the IP address owner if its link local address does not match the interface link local address.

To remove an IPv6 address from a virtual router, use the **no** form of the **vrrp3 address** command. For example:

```
-> vrrp3 6 4 admin-state disable
-> vrrp3 6 4 no address fe80::200:5eff:fe00:20a
```

In this example, VRRPv3 virtual router 6 is disabled. (A VRRPv3 virtual router must be disabled before IPv6 addresses may be added/removed from the router.) IP address `fe80::200:5eff:fe00:20a` is then removed from the virtual router with the **no** form of the **vrrp3 address** command.

Configuring the VRRPv3 Advertisement Interval

The advertisement interval is configurable, but all virtual routers with the same VRID must be configured with the same value. If the advertisement interval is set differently for a master router and a backup router, VRRPv3 packets may be dropped because the newly configured interval does not match the interval indicated in the packet. The backup router will then take over and send a neighbor advertisement, which includes the virtual router IP address and the virtual router MAC address. In addition to creating duplicate IP/MAC address messages, both routers will begin forwarding packets sent to the virtual router MAC address. This will result in forwarding duplicate packets.

To avoid duplicate addresses and packets, make sure the advertisement interval is configured the same on both the master and the backup router.

To configure the advertisement interval, use the **vrrp3** command with the **interval** keyword. For example:

```
-> vrrp3 6 4 admin-state disable
-> vrrp3 6 4 interval 500
```

In this example, VRRPv3 virtual router 6 is disabled. (If you are modifying an existing virtual router, the virtual router must be disabled before it may be modified.) The **vrrp3** command is then used to set the advertising interval for virtual router 6 to 500 centiseconds.

Configuring the VRRPv3 Virtual Router Priority

VRRPv3 functions with one master virtual router and at least one backup virtual router. A priority value determines the role each router plays. It also decides the selection of backup routers for taking over as the master router, if the master router is unavailable.

Priority values range from 1 to 255. A value of 255 indicates that the virtual router owns the IPv6 address; that is, the router contains the real physical interface to which the IPv6 address is assigned. The switch can change the default value and set it to 255 if it detects that the router is the IPv6 address owner. The value cannot be set to 255 if the router is not the IPv6 address owner.

The IPv6 address owner will always be the master router if it is available. If more than one backup router is configured, their priority values must be configured with different values, so that the backup with the higher value will take over for the master. The priority parameter may be used to control the order in which backup routers will take over for the master. If priority values are the same, any backup will take over for master.

Note that the switch sets the priority value to zero in the last VRRPv3 advertisement packet before a master router is disabled (see [“Enabling/Disabling a VRRPv3 Virtual Router” on page 24-23](#)).

Also, if a router is the IPv6 address owner and the priority value is not set to 255, the switch will set its priority to 255 when the router is enabled.

To set the priority, use the **vrrp3** command with the **priority** keyword and the desired value. For example:

```
-> vrrp3 6 4 admin-state disable
-> vrrp3 6 4 priority 50
```

In this example, VRRPv3 virtual router 6 is disabled. (If you are modifying an existing virtual router, the virtual router must be disabled before it may be modified.) The virtual router priority is then set to 50. The priority value is relative to the priority value configured for other virtual routers backing up the same IPv6 address. Changing the default priority value and setting it to 50 would typically provide a router with lower priority in the VRRPv3 network.

Setting Preemption for VRRPv3 Virtual Routers

When a VRRPv3 master virtual router becomes unavailable (goes down for whatever reason), a backup router will take over. When there is more than one backup router and if the backup routers have priority values that are very nearly equal, the skew time may not be sufficient to overcome delays caused by network traffic loads and a lower priority backup may assume control before a higher priority backup. But when the preempt mode is enabled the higher priority backup router will detect this and assume control.

By default VRRPv3 virtual routers are allowed to preempt each other; that is, if the virtual router with the highest priority will take over if the master router becomes unavailable. The preempt mode may be disabled so that any backup router that takes over when the master is unavailable will not then be preempted by a backup with a higher priority.

Note. The VRRPv3 virtual router that owns the IPv6 address(es) associated with the physical router always becomes the master router if is available, regardless of the preempt mode setting and the priority values of the backup routers.

To disable preemption for a VRRPv3 virtual router, use the **vrrp3** command with the **no preempt** keywords. For example:

```
-> vrrp3 6 4 admin-state disable
-> vrrp3 6 4 no preempt
```

In this example, virtual router 6 is disabled. (If you are modifying an existing virtual router, the virtual router must be disabled before it may be modified.) The virtual router is then configured to disable preemption. If this virtual router takes over for an unavailable router, a router with a higher priority will not be able to preempt it. For more information about priority, see [“Configuring the VRRPv3 Virtual Router Priority” on page 24-21](#).

Enabling/Disabling a VRRPv3 Virtual Router

To change the default status of the VRRPv3 virtual router and to enable it, use the **vrrp3** command with the **enable** keyword. For example:

```
-> vrrp3 7 3
-> vrrp3 7 3 admin-state enable
```

In this example, a VRRPv3 virtual router is created on VLAN 3 with a VRID of 7. An IPv6 address is then assigned to the virtual router. The virtual router is then enabled on the switch.

To disable a VRRPv3 virtual router, use the **disable** keyword.

```
-> vrrp 7 3 admin-state disable
```

A VRRPv3 virtual router must be disabled before it may be modified. Use the **vrrp3** command to disable the virtual router first; then use the command again to modify the parameters. For example:

```
-> vrrp3 7 3 admin-state disable
-> vrrp3 7 3 priority 200
-> vrrp3 7 3 admin-state enable
```

In this example, VRRPv3 virtual router 7 on VLAN 3 is disabled. The VRRPv3 virtual router is then modified to change its priority setting. (For information about configuring the priority setting, see [“Configuring the VRRPv3 Virtual Router Priority” on page 24-21.](#)) The virtual router is then re-enabled and will be active on the switch.

Setting VRRPv3 Traps

A VRRPv3 router has the capability to generate VRRPv3 SNMP traps for events defined in the VRRPv3 SNMP MIB.

In order for VRRPv3 traps to be generated correctly, traps in general must be enabled on the switch through the SNMP CLI. See the *OmniSwitch AOS Release 8 Switch Management Guide* for more information about enabling SNMP traps globally.

To disable VRRPv3 traps, use the **no** form of the **vrrp3 trap** command.

```
-> no vrrp3 trap
```

To re-enable traps, enter the **vrrp3 trap** command:

```
-> vrrp3 trap
```

Verifying the VRRPv3 Configuration

A summary of the **show** commands used for verifying the VRRPv3 configuration is given here:

- | | |
|-------------------------------------|--|
| show vrrp3 | Displays the VRRPv3 virtual router configuration for all virtual routers or for a particular virtual router. |
| show vrrp3 statistics | Displays statistics about VRRPv3 packets for all VRRPv3 virtual routers configured on the switch or for a particular virtual router. |
| show vrrp3 track-association | Displays the tracking policies associated with VRRPv3 virtual routers. |

For more information about the displays that result from these commands, see the *OmniSwitch AOS Release 8 CLI Reference Guide*.

Creating Tracking Policies

To create a tracking policy, use the **vrrp track** command and specify the amount to decrease a virtual router's priority and the port, IP address, or IP interface name to be tracked. For example:

```
-> vrrp track 3 admin-state enable priority 50 address 20.1.1.3
```

In this example, a tracking policy ID (3) is created and enabled for IP address 20.1.1.3. If this address becomes unreachable, a virtual router associated with this track ID will have its priority decremented by 50. Note that the **enable** keyword administratively activates the tracking policy, but the policy does not take effect until it is associated with one or more virtual routers (see the next section).

Similarly, to create a tracking policy ID (3) for IPv6 address 213:100:1::56, use the following command:

```
-> vrrp track 3 admin-state enable priority 50 address 213:100:1::56
```

If this address becomes unreachable, a virtual router associated with this track ID will have its priority decremented by 50.

Note the following:

- A virtual router must be administratively disabled before a tracking policy for the virtual router can be added.
- VRRP tracking does not override IP address ownership (the IP address owner will always have priority to become master, if it is available).

Associating a Tracking Policy with a VRRPv2/VRRPv3 Virtual Router

To associate a tracking policy with a virtual router, use the **vrrp track-association** command with the tracking policy ID number. In this example, virtual router 6 on VLAN 4 is disabled first so that tracking policy 3 may be associated with it:

```
-> vrrp 6 4 admin-state disable  
-> vrrp 6 4 track-association 3
```

When the virtual router is re-enabled, tracking policy 3 will be used for that virtual router.

A tracking policy must not be associated with a virtual router on the same port or interface. For example:

```
-> ip interface vlan-4 address 10.1.1.1 vlan 4  
-> vrrp track 2 ipv4-interface vlan-4  
-> vrrp 5 4 track-association 2
```

This configuration is allowed but will not really have an effect. If the associated interface goes down, this virtual router goes down as well and the tracking policy is not applied.

Note. A master and a backup virtual router must not be tracking the same IP address; otherwise, when the IP address becomes unreachable, both virtual routers will have their priorities decremented, and the backup may temporarily take over if the master discovers that the IP address is unreachable before the backup.

Typically you must not configure the same IP address tracking policies on physical VRRP routers that backup each other; otherwise, the priority will be decremented for both master and backup when the entity being tracked goes down.

VRRP Application Example

In addition to providing redundancy, VRRP can assist in load balancing outgoing traffic. The figure below shows two virtual routers with their hosts splitting traffic between them. Half of the hosts are configured with a default route to virtual router 1's IP address (10.10.2.250), and the other half are configured with a default route to virtual router 2's IP address (10.10.2.245).

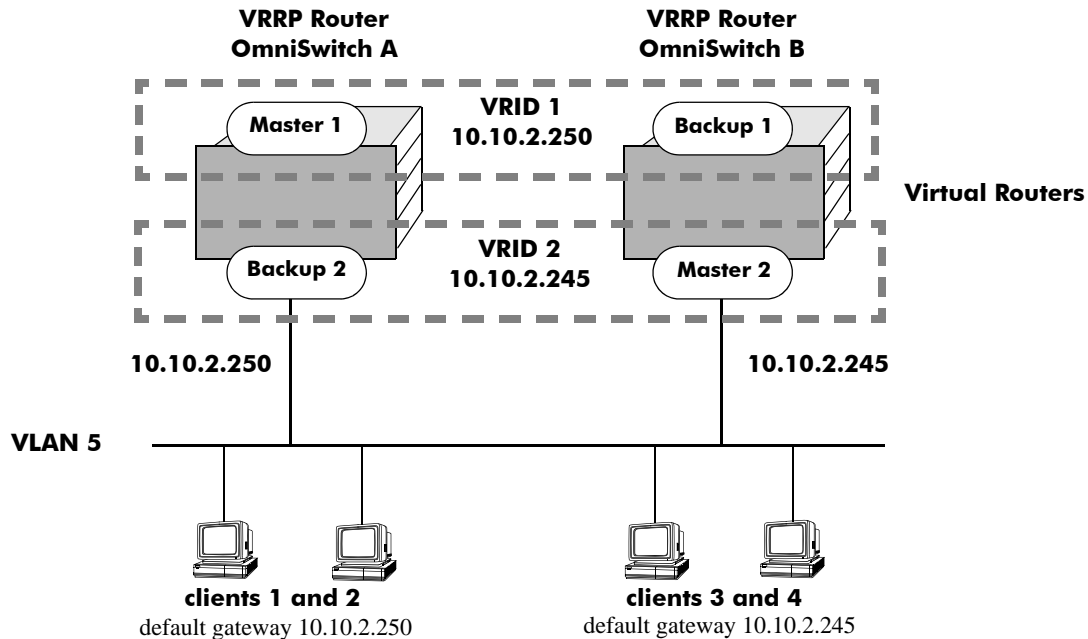

VRRP Redundancy and Load Balancing

The CLI commands used to configure this setup are as follows:

- 1 First, create two virtual routers for VLAN 5. (Note that VLAN 5 must already be created and available on the switch.)

```
-> vrrp 1 5
-> vrrp 2 5
```

- 2 Configure the IP addresses for each virtual router.

```
-> vrrp 1 5 ip 10.10.2.250
-> vrrp 2 5 ip 10.10.2.245
```

- 3 Enable the virtual routers.

```
-> vrrp 1 5 admin-state enable
-> vrrp 2 5 admin-state enable
```

Note. The same VRRP configuration must be set up on each switch. The VRRP router that contains, or owns, the IP address will automatically become the master for that virtual router. If the IP address is a virtual address, the virtual router with the highest priority will become the master router.

In this scenario, the master of VRID 1 will respond to ARP requests for IP address A using the virtual router MAC address for VRID 1 (00:00:5E:00:01:01). OmniSwitch 1 is the master for VRID 1 since it contains the physical interface to which 10.10.2.250 is assigned. If OmniSwitch A must become unavailable, OmniSwitch B will become master for VRID 1.

In the same way, the master of VRID 2 will respond to ARP requests for IP address B using the virtual router MAC address for VRID 2 (00:00:5E:00:01:02). OmniSwitch B is the master for VRID 2 since it contains the physical interface to which 10.10.2.245 is assigned. If OmniSwitch B must become unavailable, OmniSwitch A will become master for 10.10.2.245. This configuration provides uninterrupted service for the end hosts.

VRRP Tracking Example

The figure below shows two VRRP routers with two virtual routers backing up one IP address on each VRRP router respectively. Virtual router 1 serves as the default gateway on OmniSwitch A for clients 1 and 2 through IP address 10.10.2.250 and virtual router 2 serves as default gateway on OmniSwitch B for clients 3 and 4 through IP address 10.10.2.245. For example, if the port that provides access to the Internet on OmniSwitch A fails, virtual router 1 will continue to be the default router for clients 1 and 2, but clients 1 and 2 will not be able to access the Internet.

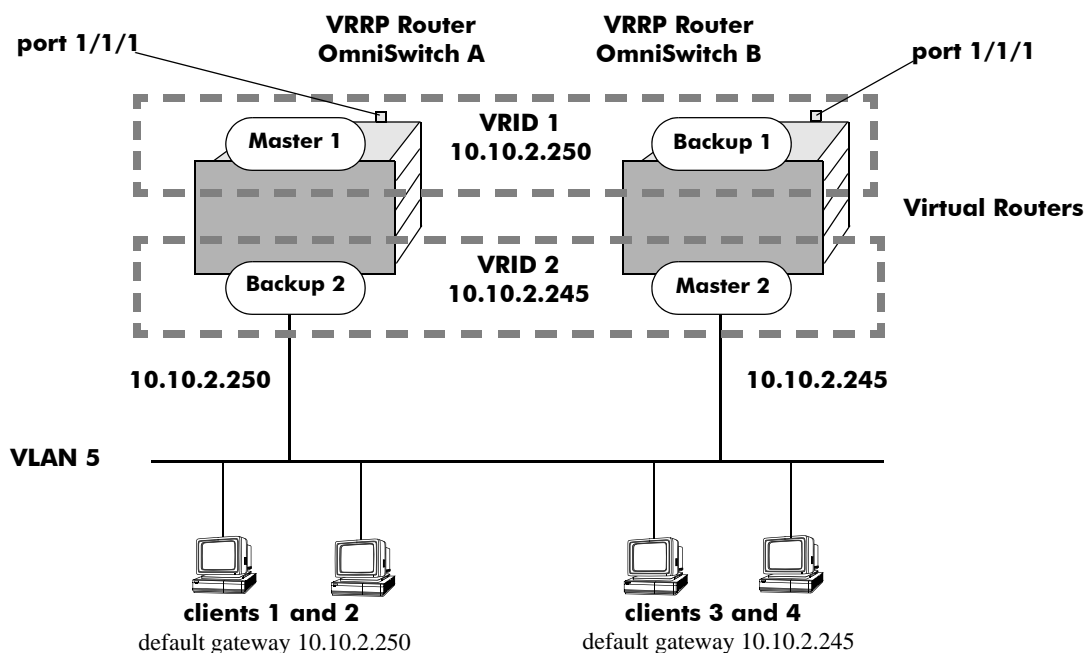

VRRP Tracking Example

In this example, the master for virtual router 1 has a priority of 100 and the backup for virtual router 1 has a priority of 75. The virtual router configuration for VRID 1 and 2 on VRRP router A is as follows:

```
-> vrrp 1 5 priority 100 preempt
-> vrrp 2 5 priority 75
```

The virtual router configuration for VRID 1 and 2 on VRRP router B is as follows:

```
-> vrrp 1 5 priority 75
-> vrrp 2 5 priority 100 preempt
```

To ensure workstation clients 1 and 2 have connectivity to the internet, configure a tracking policy on VRRP router A to monitor port 1/1/1 and associate the policy with VRID 1.

```
-> vrrp track 1 admin-state enable priority 50 port 1/1/1
-> vrrp 1 5 track-association 1
```

If port 1/1/1 on VRRP router A goes down, the master for virtual router A is still functioning but workstation clients 1 and 2 will not be able to get to the Internet. With this tracking policy enabled, however, master router 1's priority will be temporarily decremented to 50, allowing backup router 1 to take over and provide connectivity for those workstations. When port 1/1/1 on VRRP router A comes backup, master 1 will take over again.

Note. Preempt must be set on switch A virtual router 1, and switch B virtual router 2, in order for the correct master to assume control once their respective ports 1/1/1 return to viability. In our example, once port 1/1/1 on switch A is functioning again we want switch A to reestablish itself as the master. See [“Setting Preemption for Virtual Routers” on page 24-13](#) for more information about enabling preemption.

VRRPv3 Application Example

In addition to providing redundancy, VRRPv3 can assist in load balancing outgoing traffic. The figure below shows two virtual routers with their hosts splitting traffic between them. Half of the hosts are configured with a default route to virtual router 1's IPv6 address (213:100:1::56), and the other half are configured with a default route to virtual router 2's IPv6 address (213:100:1::57).

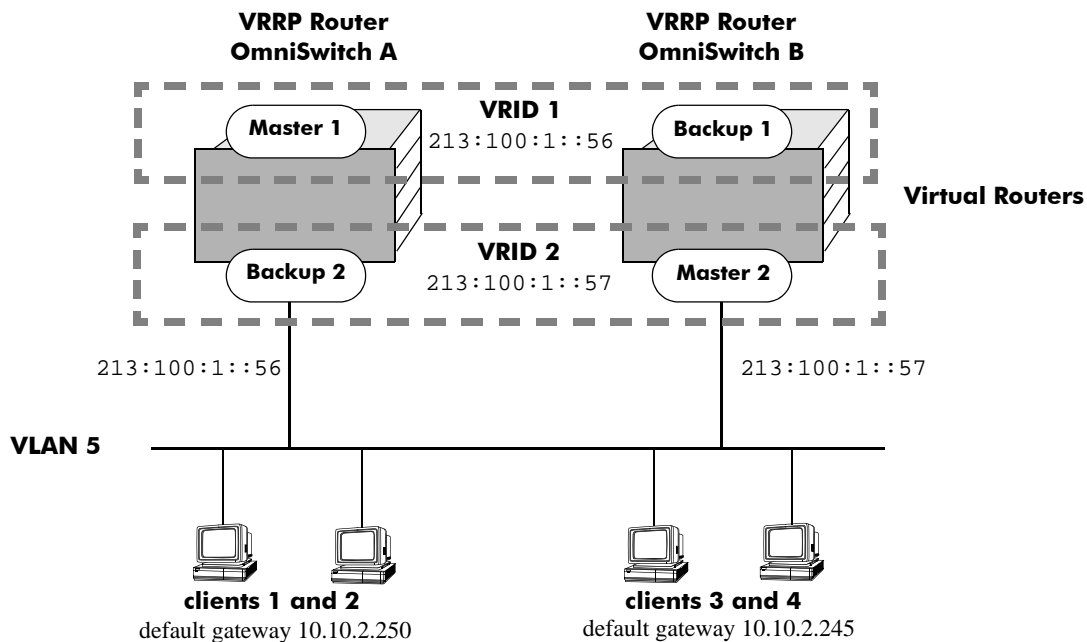

VRRPv3 Redundancy and Load Balancing

The CLI commands used to configure this setup are as follows:

- 1 First, create two VRRPv3 virtual routers for VLAN 5. (Note that VLAN 5 must already be created and available on the switch.)

```
-> vrrp3 1 5
-> vrrp3 2 5
```

- 2 Configure the IPv6 addresses for each VRRPv3 virtual router.

```
-> vrrp3 1 5 address 213:100:1::56
-> vrrp3 2 5 address 213:100:1::57
```

- 3 Enable the VRRPv3 virtual routers.

```
-> vrrp3 1 5 admin-state enable
-> vrrp3 2 5 admin-state enable
```

Note. The same VRRPv3 configuration must be set up on each switch. The VRRPv3 router that contains, or owns, the IPv6 address will automatically become the master for that virtual router. If the IPv6 address is a virtual address, the virtual router with the highest priority will become the master router.

In this scenario, the master of VRID 1 will respond to neighbor solicitation with a neighbor advertisement for IPv6 address A using the virtual router MAC address for VRID 1 (00:00:5E:00:02:01). OmniSwitch 1 is the master for VRID 1 since it contains the physical interface to which 213:100:1::56s assigned. If OmniSwitch A must become unavailable, OmniSwitch B will become master for VRID 1.

In the same way, the master of VRID 2 will respond to neighbor solicitation for IPv6 address B using the virtual router MAC address for VRID 2 (00:00:5E:00:02:02). OmniSwitch B is the master for VRID 2 since it contains the physical interface to which 213:100:1::57 is assigned. If OmniSwitch B must become unavailable, OmniSwitch A will become master for 213:100:1::57. This configuration provides uninterrupted service for the end hosts.

VRRPv3 Tracking Example

The figure below shows two VRRPv3 routers with two virtual routers backing up one IPv6 address on each VRRPv3 router respectively. Virtual router 1 serves as the default gateway on OmniSwitch A for clients 1 and 2 through IPv6 address 213:100:1::56. For example, if the port that provides access to the Internet on OmniSwitch A fails, virtual router 1 will continue to be the default router for clients 1 and 2, but clients 1 and 2 will not be able to access the Internet.

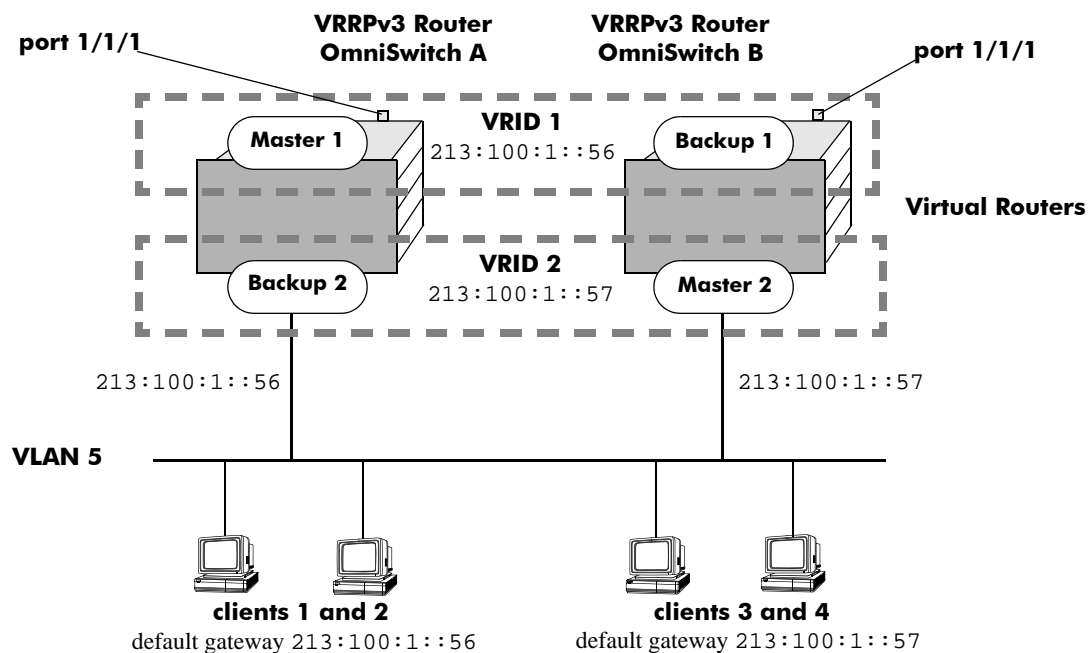

VRRPv3 Tracking Example

In this example, the master for virtual router 1 has a priority of 100 and the backup for virtual router 1 has a priority of 75. The virtual router configuration for VRID 1 and 2 on VRRPv3 router A is as follows:

```
-> vrrp3 1 5 priority 100 preempt
-> vrrp3 2 5 priority 75
```

The virtual router configuration for VRID 1 and 2 on VRRPv3 router B is as follows:

```
-> vrrp3 1 5 priority 75
-> vrrp3 2 5 priority 100 preempt
```

To ensure workstation clients 1 and 2 have connectivity to the internet, configure a tracking policy on VRRPv3 router A to monitor port 1/1/1 and associate the policy with VRID 1.

```
-> vrrp3 track 1 admin-state enable priority 50 port 1/1/1
-> vrrp3 1 5 track-association 1
```

If port 1/1/1 on VRR3 router A goes down, the master for virtual router A is still functioning, but workstation clients 1 and 2 will not be able to get to the Internet. With this tracking policy enabled, however, master router 1's priority will be temporarily decremented to 50, allowing backup router 1 to take over and provide connectivity for those workstations. When port 1/1/1 on VRRPv3 router A comes backup, master 1 will take over again.

Note. Preempt must be set on switch A virtual router 1, and switch B virtual router 2, in order for the correct master to assume control once their respective ports 1/1/1 return to viability. In our example, once port 1/1/1 on switch A is functioning again we want switch A to reestablish itself as the master. See [“Setting Preemption for Virtual Routers” on page 24-13](#) for more information about enabling preemption.

25 Configuring Server Load Balancing

Alcatel-Lucent's Server Load Balancing (SLB) software provides a method to logically manage a group of physical servers sharing the same content (known as a *server farm*) as one large virtual server (known as an *SLB cluster*). SLB clusters are identified and accessed using either a Virtual IP (VIP) address or a QoS policy condition. Traffic is always routed to VIP clusters and either bridged or routed to policy condition clusters. The OmniSwitch operates at wire speed to process client requests and then forward them to the physical servers within the cluster.

Using SLB clusters can provide cost savings (costly hardware upgrades can be delayed or avoided), scalability (as the demands on your server farm grow you can add additional physical servers), reliability (if one physical server goes down the remaining servers can handle the remaining workload), and flexibility (you can tailor workload requirements individually to servers within a cluster).

In This Chapter

This chapter describes the basic components of Server Load Balancing and how to configure them through the Command Line Interface (CLI). CLI commands are used in the configuration examples; for more details about the syntax of commands, see the *OmniSwitch AOS Release 8 CLI Reference Guide*.

Configuration procedures described in this chapter include:

- Procedures to configure SLB on a switch on [page 25-11](#).
- Procedures to configure logical SLB clusters on [page 25-12](#).
- Procedures to configure physical servers in SLB clusters on [page 25-14](#).
- Procedures to configure SLB probes on [page 25-18](#).
- Procedures for troubleshooting and maintenance on [page 25-17](#) and [page 25-22](#).

Note. You can also configure and monitor Server Load Balancing with WebView, Alcatel-Lucent's embedded web-based device management application. WebView is an interactive and easy-to-use GUI that can be launched from OmniVista or a web browser. Please refer to WebView online documentation for more information on configuring and monitoring Server Load Balancing with WebView.

Server Load Balancing Specifications

The table below lists specifications for Alcatel-Lucent's SLB software.

Platforms Supported	OmniSwitch 6860, 6860E
Maximum number of clusters	32
Maximum number of physical servers per cluster	32
Layer-3 classification	Destination IP address QoS policy condition
Layer-2 classification	QoS policy condition
Server health checking	Ping, link checks
Networking protocols supported	Virtual IP (VIP) addresses

Server Load Balancing Default Values

The following table lists default values for the SLB software:.

Parameter Description	Command	Default Value/Comments
Global SLB administrative status	ip slb admin-state	Disabled
Ping period	ip slb cluster ping period	60 seconds
Ping timeout	ip slb cluster ping timeout	3000 milliseconds
Ping retries	ip slb cluster ping retries	3
Administrative status of an SLB cluster	ip slb cluster admin-state	Enabled
Administrative status of physical servers in an SLB cluster	ip slb server ip cluster	Enabled
Relative weight of a physical server in an SLB cluster	ip slb server ip cluster	1
SLB probes configured	ip slb probe	None configured
SLB probe timeout	ip slb probe timeout	3000 seconds
SLB probe period	ip slb probe period	60 seconds
SLB probe port number	ip slb probe port	0
SLB probe retries	ip slb probe retries	3
SLB probe user name	ip slb probe username	None configured
SLB probe password	ip slb probe password	None configured
SLB probe URL	ip slb probe url	None configured
SLB probe expected status	ip slb probe status	200
SLB probe send string	ip slb probe send	None configured
SLB probe expect string	ip slb probe expect	None configured

Quick Steps for Configuring Server Load Balancing

Follow the steps below for a quick tutorial on configuring parameters for SLB. Additional information on how to configure each command is given in the subsections that follow. Note that this example configures a VIP cluster. See the tutorial on [page 25-5](#) for quick steps on configuring a QoS policy condition cluster.

- 1 Enable SLB globally with the **ip slb admin-state** command as shown below:

```
-> ip slb admin-state enable
```

- 2 Configure the SLB VIP cluster using the **ip slb cluster** command with the **vip** parameter. For example:

```
-> ip slb cluster WorldWideWeb vip 128.241.130.204
```

- 3 Assign physical servers to the SLB cluster and specify a relative weight for each server (default value for weight is 1) with the **ip slb server ip cluster** command. For example:

```
-> ip slb server ip 128.241.130.127 cluster WorldWideWeb
-> ip slb server ip 128.241.130.109 cluster WorldWideWeb weight 4
-> ip slb server ip 128.241.130.115 cluster WorldWideWeb weight 6
-> ip slb server ip 128.241.130.135 cluster WorldWideWeb admin-state disable
weight 8
```

As an option, you can verify your SLB settings by entering **show ip slb cluster** followed by the name of the SLB cluster. For example:

```
-> show ip slb cluster WorldWideWeb
```

```
Cluster WorldWideWeb
  VIP                : 128.241.130.204,
  Type                : L3,
  Admin status        : Enabled,
  Operational status  : In Service,
  Ping period (seconds) : 60,
  Ping timeout (milliseconds) : 3000,
  Ping retries        : 3,
  Probe               : None,
  Number of packets   : 3800,
  Number of servers   : 4
  Server 128.241.130.109
    Admin status = Enabled, Operational Status = In Service,
    Weight = 4, Availability (%) = 100
  Server 128.241.130.115
    Admin status = Enabled, Operational Status = In Service,
    Weight = 6, Availability (%) = 98
  Server 128.241.130.127
    Admin status = Enabled, Operational Status = Discovery,
    Weight = 1, Availability (%) = 0
  Server 128.241.130.135
    Admin status = Disabled, Operational Status = Disabled,
    Weight = 8, Availability (%) = 0
```

An example of what these configuration commands look like entered sequentially on the command line:

```
-> ip slb admin-state enable
-> ip slb cluster WorldWideWeb vip 128.241.130.204
-> ip slb server ip 128.241.130.127 cluster WorldWideWeb
```

```
-> ip slb server ip 128.241.130.109 cluster WorldWideWeb weight 4
-> ip slb server ip 128.241.130.115 cluster WorldWideWeb weight 6
-> ip slb server ip 128.241.130.135 cluster WorldWideWeb admin-state disable
weight 8
```

Quick Steps for Configuring a QoS Policy Condition Cluster

Follow the steps below for a quick tutorial on how to configure a QoS policy condition cluster:

1 Create the QoS policy condition that classifies traffic for the SLB cluster. For example:

```
-> policy network group SOURCE 100.0.0.1 100.0.0.2 100.0.0.3 100.0.0.4
-> policy condition c1 source network group SOURCE destination tcp-port 80
-> qos apply
```

2 Configure the SLB cluster using the **ip slb cluster** command with the **condition** parameter. For example:

```
-> ip slb cluster Intranet condition c1
```

3 Assign physical servers to the SLB condition cluster and specify a relative weight for each server (default value for weight is 1) with the **ip slb server ip cluster** command. For example:

```
-> ip slb server ip 103.10.50.1 cluster Intranet
-> ip slb server ip 103.10.50.2 cluster Intranet weight 4
-> ip slb server ip 103.10.50.3 cluster Intranet admin-state disable weight 2
```

Note. As an option, you can configure an SLB server as a backup server. See [“Configuring a Server in an SLB Cluster as a Backup Server”](#) on page 25-16 for more information.

As an option, you can verify your SLB settings by entering **show ip slb cluster** followed by the name of the SLB cluster. For example:

```
-> show ip slb cluster Intranet
```

```
Cluster Intranet
VIP                : 123.12.1.2,
Type               : L3
Admin status       : Enabled,
Operational status : In Service,
Ping period (seconds) = 60,
Ping timeout (milliseconds) = 3000,
Ping retries       : 3,
Probe              : None,
Number of packets  : 10000,
Number of servers  : 2
  Server 103.10.50.1
    Admin status = Enabled, Operational status = In Service,
    Weight = 1, Availability (%) = 100
  Server 103.10.50.2
    Admin status = Enabled, Operational status = In Service,
    Weight = 4, Availability (%) = 99
  Server 103.10.50.3
    Admin status = Disabled, Operational status = Disabled,
    Weight = 2, Availability (%) = 0
```

As an option, you can also display traffic statistics for an SLB condition cluster by entering **show ip slb cluster** followed by the cluster name and the **statistics** parameter. For example, the following command displays the packet count for traffic that is classified for the “Intranet” cluster:

```
-> show ip slb cluster Intranet statistics
```

Cluster Name	Admin Status	Operational Status	Count
Intranet	Enabled	In Service	2 Servers
Src IP 100.0.0.1/255.255.255.255			2500
IP Dst TCP Port 80			
Src IP 100.0.0.2/255.255.255.255			2500
IP Dst TCP Port 80			
Src IP 100.0.0.3/255.255.255.255			2500
IP Dst TCP Port 80			
Src IP 100.0.0.4/255.255.255.255			2500
IP Dst TCP Port 80			

An example of what the configuration commands look like entered sequentially on the command line:

```
-> policy network group SOURCE 100.0.0.1 100.0.0.2 100.0.0.3 100.0.0.4
-> policy condition c1 source network group SOURCE destination tcp-port 80
-> qos apply
-> ip slb cluster Intranet condition c1
-> ip slb server ip 103.10.50.1 cluster Intranet
-> ip slb server ip 103.10.50.2 cluster Intranet weight 4
-> ip slb server ip 103.10.50.3 cluster Intranet admin-state disable weight 2
```

You can verify your SLB settings by entering **show ip slb cluster server** followed by the name of the SLB cluster. For example:

```
-> show ip slb cluster Intranet server 103.10.50.3
```

```
Cluster Intranet
VIP 103.10.50.50
Server 103.10.50.3
Admin status           : Disabled,
Oper status            : In Service,
Probe                  = None,
Admin weight           = 2,
Availability time (%)  = 98,
Ping failures          = 0,
Last ping round trip time (milliseconds) = 1,
Probe status           = OK,
```

Note. Once a cluster is created, the Virtual IP or condition cannot be modified. To modify these values, delete the cluster and re-create the cluster with the different VIP and conditions.

Server Load Balancing Overview

The following sections describe SLB operational theory (see [“Server Load Balancing Cluster Identification” on page 25-7](#)), an SLB example ([“Server Load Balancing Example” on page 25-8](#)), and server health monitoring (see [“Server Health Monitoring” on page 25-10](#)).

Note. Alcatel-Lucent also offers link aggregation, which combines multiple Ethernet links into one virtual channel. Please refer to [Chapter 10, “Configuring Dynamic Link Aggregation,”](#) for more information on link aggregation and dynamic link aggregation, and to [Chapter 9, “Configuring Static Link Aggregation,”](#) for information on static (OmniChannel) link aggregation.

Server Load Balancing Cluster Identification

An SLB cluster consists of a group of physical servers, also known as a server farm. The SLB cluster appears as one large virtual server, which is identified using one of the following methods:

- **Virtual IP (VIP)**—An IP address is assigned to the cluster (virtual server). Client requests destined for this VIP are routed (Layer-3 mode) to the servers that are members of the VIP cluster. Note that it is necessary to configure cluster servers with a loopback interface.
- **Condition**—A QoS policy condition name is assigned to the cluster (virtual server). Client requests that meet the criteria of the policy condition are bridged (Layer-2 mode) or routed (Layer-3 mode) to the servers that are members of the condition cluster. Note that it is *not* necessary to configure cluster servers with a loopback interface.

Note. See [“Configuring and Deleting SLB Clusters” on page 25-12](#) for more information on configuring VIP and condition clusters.

Server Load Balancing Cluster Modes

The cluster mode refers to whether client requests are bridged (Layer-2 mode) or routed (Layer-3 mode) by the switch to the appropriate SLB cluster. A VIP cluster only supports Layer-3 mode, so request packets are always routed to the cluster. A condition cluster supports both Layer-2 *and* Layer-3 modes.

When the Layer-3 mode is active (VIP or condition clusters), routed packets are modified as follows:

- The source IP address is changed to the IP address for the switch router interface.
- The destination IP address is changed to the IP address of the destined server.
- The TTL value is decremented.

When the Layer-2 mode is active (condition clusters only), request packets are not modified and are only switched within the same VLAN domain. The Layer-2 or Layer-3 mode is selected when the condition cluster is configured on the switch. See [“Configuring an SLB Cluster with a QoS Policy Condition” on page 25-12](#) for more information.

Server Load Balancing Example

In the figure on the following page, an SLB cluster consisting of four (4) physical servers has been configured with a VIP of 128.241.130.204 and an SLB cluster name of “WorldWideWeb.” The switch processes requests sent by clients to the VIP of 128.241.130.204 and sends to the appropriate physical server, depending on configuration and the operational states of the physical servers. The switch then transmits the requested data from the physical server back to the client.

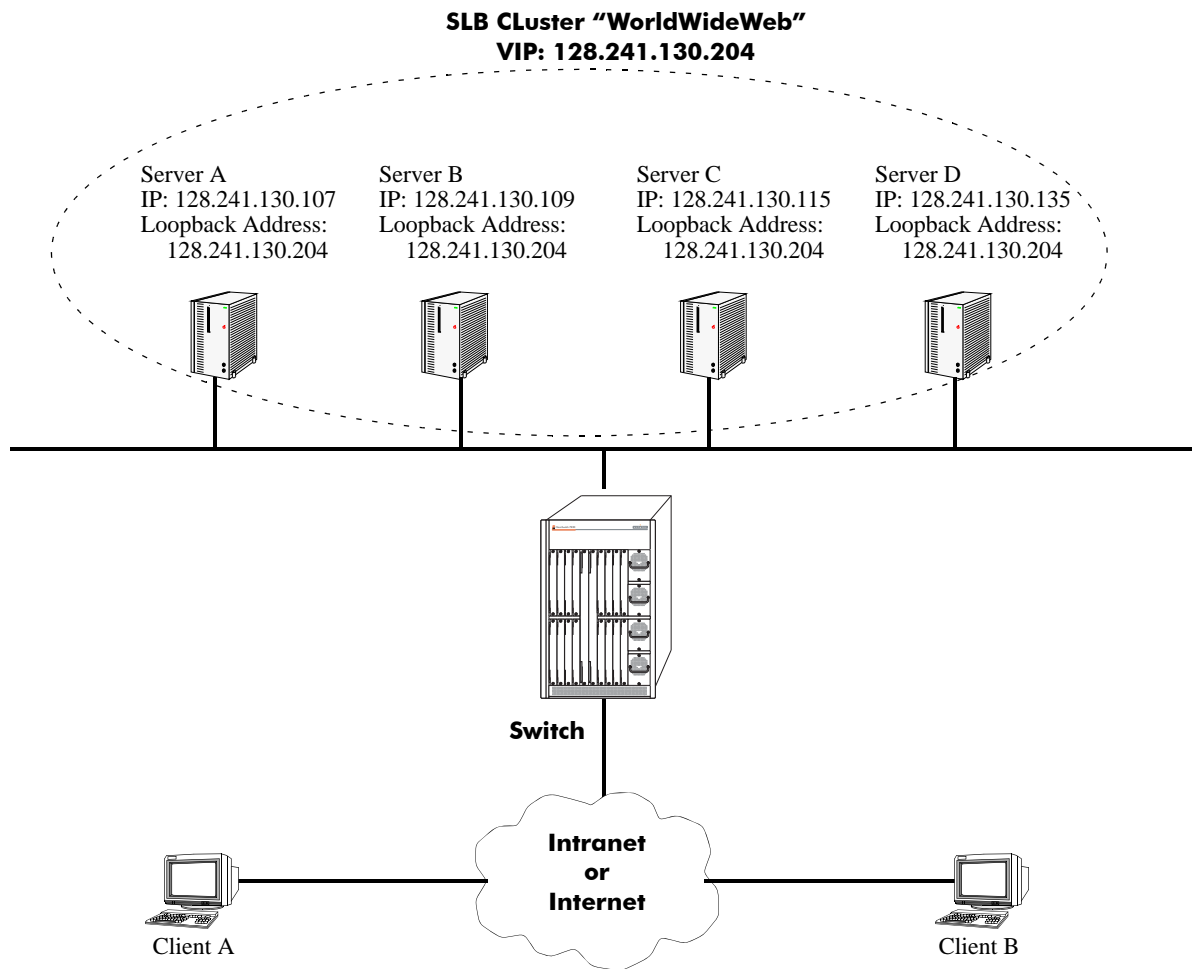

Example of a Server Load Balancing (SLB) Cluster

Weighted Round Robin Distribution Algorithm

In order to distribute traffic among operating servers, the SLB cluster must have a method of selecting a server among a pool (cluster) of operating servers (“in service” mode) depending on some criteria. This method is commonly called the SLB cluster *distribution algorithm*.

The distribution algorithm on an Alcatel-Lucent switch is weighted round robin, where the SLB cluster distributes traffic according to the relative “weight” a server has within an SLB cluster. In the figure below, for example, Server A has been assigned by the network administrator a relative weight of 30, which is the largest weight in the SLB cluster called “WorldWideWeb.” Server A handles twice as much traffic as Server C (which has a weight of 15), three times the traffic of Server D (which has a weight of 10), and six times the traffic of Server B (which has a weight of 5).

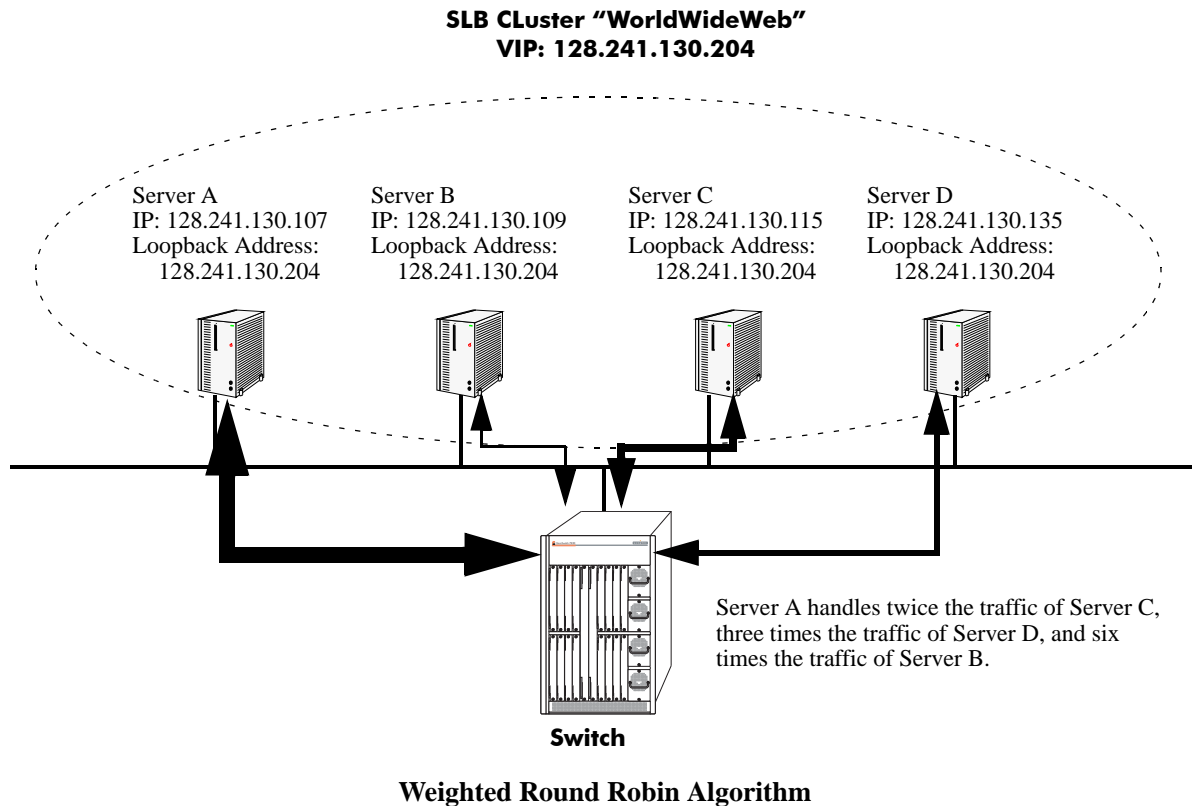

Note. See [“Modifying the Relative Weight of a Physical Server”](#) on page 25-16 for information on modifying the relative weights of servers in an SLB cluster.

Server Health Monitoring

Alcatel-Lucent's Server Load Balancing (SLB) software on the switch performs checks on the links from the switch to the servers. In addition, the SLB software also sends ICMP echo requests (ping packets) to the physical servers to determine their availability.

Note. You can use the [show ip slb cluster server](#) command, which is described in “[Displaying Server Load Balancing Status and Statistics](#)” on page 25-22, to display link and ping status of physical servers.

These health checks performed by the switch are used by the SLB software to determine the operational states of servers. The possible operational states are described in the table below:

Operational States

Disabled	The server has been administratively disabled by the user.
No Answer	The server has not responded to ping requests from the switch.
Link Down	There is a bad connection to the server.
Discovery	The switch is pinging a physical server.
In Service	The server can be used for client connections.
Retrying	The switch is making another attempt to bring up the server.

In Release 5.1.6 and later you can configure probes to monitor the health of clusters and servers. See “[Configuring SLB Probes](#)” on page 25-18 for more information.

Configuring Server Load Balancing on a Switch

This section describes how to use Alcatel-Lucent's Command Line Interface (CLI) commands to configure Server Load Balancing (SLB) on a switch.

Note. See [“Quick Steps for Configuring Server Load Balancing” on page 25-4](#) for a brief tutorial on configuring these mandatory parameters.

When configuring SLB parameters for an SLB cluster, you must perform the following steps:

- 1 Enable Server Load Balancing on Your Switch.** To enable Server Load Balancing (SLB) on a switch, use the **ip slb admin-state** command, which is described in [“Enabling and Disabling Server Load Balancing” on page 25-11](#).
- 2 Configure the Logical Server Load Balancing Cluster.** To configure a logical SLB cluster, use the **ip slb cluster** command, which is described in [“Configuring and Deleting SLB Clusters” on page 25-12](#).
- 3 Assign Physical Servers to the Logical Server Load Balancing Cluster.** To add physical servers to a logical SLB cluster, use the **ip slb server ip cluster** command, which is described in [“Assigning Servers to and Removing Servers from a Cluster” on page 25-14](#).

Note. Routing (which is enabled by default) must be enabled on a switch or Server Load Balancing will not operate.

Alcatel-Lucent's SLB software is preconfigured with the default values shown in the table in [“Server Load Balancing Default Values” on page 25-3](#). Depending on the requirements of your network and server farm, you may need to configure more parameters than the mandatory ones described in this section. See [“Modifying Optional Parameters” on page 25-15](#) for information on configuring additional SLB parameters.

Enabling and Disabling Server Load Balancing

By default, Server Load Balancing (SLB) is disabled on a switch. The following subsections describe how to enable and disable SLB on a switch with the **ip slb admin-state** command.

Note. You must enable or disable Server Load Balancing on an entire switch. You cannot enable SLB on a per port or per slot basis.

Enabling SLB

To enable SLB switch wide, use the **ip slb admin-state** command by entering:

```
-> ip slb admin-state enable
```

Disabling SLB

To disable SLB switch wide, use the **ip slb admin-state** command by entering:

```
-> ip slb admin-state disable
```

Configuring and Deleting SLB Clusters

The following subsections describe how to configure and delete SLB clusters with the **ip slb cluster** command.

Configuring an SLB Cluster with a VIP Address

Consider the following when configuring a VIP cluster:

- Specify a cluster name that is at least 1 character and less than or equal to 23 characters long.
- To use spaces in an SLB cluster name, enclose the entire name within quotation marks (for example, “web server”).
- The VIP address of the SLB cluster must be an address in the same subnet as the servers.
- VIP only supports the Layer-3 SLB mode, which is enabled by default.

To configure an SLB cluster that uses VIP classification to bridge or route client requests to the cluster servers, use the **ip slb cluster** command with the **vip** parameter. For example, to configure an SLB cluster called “Web_Server” with a VIP address of 10.123.11.14, you would enter:

```
-> ip slb cluster Web_Server vip 10.123.11.14
```

Configuring an SLB Cluster with a QoS Policy Condition

Consider the following when configuring a QoS policy condition cluster:

- Specify a cluster name that is at least 1 character and less than or equal to 23 characters long.
- To use spaces in an SLB cluster name, enclose the entire name within quotation marks (for example, “web server2”).
- The QoS policy condition name specified must be the switch configuration.

To configure an SLB cluster that uses a QoS policy condition to qualify client requests for bridging or routing to the cluster servers, use the **ip slb cluster** command with the **condition** parameter and either the **I2** or **I3** parameter. For example, to configure an SLB cluster called “Web_Server2” with the “cond1” policy condition and using the L2 mode, you would enter:

```
-> ip slb cluster Web_Server2 condition cond1 I2
```

How to Create a QoS Policy Condition

Use the **policy condition** command to create a QoS policy condition. For example, the following command creates a source port condition named “cond1”:

```
-> policy condition cond1 source port 1/1/24
```

The condition created in the above example, “cond1”, uses the source port value to classify traffic. When this same condition is associated with an SLB cluster, client requests received on the specified source port are then sent to a server that is a member of the associated cluster.

The following QoS policy conditions are supported individually and in combination with each other when used to configure SLB condition clusters:

QoS Policy Condition Keywords

source vlan	tos	ethertype
source port	dscp	protocol
destination port	802.1p	source tcp-port
source port group	source ip address	destination tcp-port
destination port group	destination ip address	source udp-port
source mac	source network group	destination udp-port
destination mac	destination network group	icmp type
source mac group	service	icmp code
destination mac group	service group	tcp flags

See [Chapter 27, “Configuring QoS,”](#) for more information about configuring and displaying QoS policy conditions.

Automatic Configuration of SLB Policy Rules

When you configure an SLB cluster, a Quality of Service (QoS) policy condition, action, and rule are automatically configured for it. In addition, the switch software automatically names the condition, action, and rule by adding the prefix **SLB-cond-**, **SLB-act-**, and **SLB-rule-**, respectively, to the name of the SLB cluster for each name.

For example, if you configured an SLB cluster called “Web_Server” a policy condition called “SLB-cond-Web_Server,” a policy action called “SLB-act-Web_Server,” and a policy rule called “SLB-rule-Web_Server” would be created.

Note that the user-configured policy condition associated with an SLB cluster is the condition used for the automatically configured SLB policy rule. For example, if you configured an SLB cluster called “Web_Server2” and associated it with the “cond1” condition, a policy rule called “SLB-rul-Web-Server2” would be created with the “cond1” condition and the “SLB-act-Web_Server2” action.

You can display QoS policy rules with the **show policy rule** command. To use this command, enter **show policy rule** followed by the name of the rule. For example, the following commands display the policy rule called “SLB-rul-Web_Server” and the policy rule called “SLB-rul-Web_Server2”:

```
-> show policy rule SLB-rul-Web-Server
Rule name           = SLB-rul-Web-Server ,
  From              = api ,
  Precedence        = 65000 ,
  Condition name    = SLB-cnd-Web-Server ,
  Action name       = SLB-act-Web-Server
```

You can also use the **show policy condition** command to display policy conditions and the **show policy action** command to display policy actions. See [Chapter 27, “Configuring QoS,”](#) for more information on configuring and displaying QoS policies.

Deleting an SLB Cluster

To delete an SLB cluster, use the **no** form of the **ip slb reset statistics** command by entering **no ip slb cluster** followed by the name of the cluster.

For example, to delete an SLB called “Web_Server”, you would enter:

```
-> no ip slb cluster Web_Server
```

Note. When you delete an SLB cluster you also delete the QoS policy, condition, and rule associated with the cluster.

Assigning Servers to and Removing Servers from a Cluster

The following subsections describe how to assign servers to an SLB cluster and how to remove servers from an SLB cluster with the **ip slb server ip cluster** command.

Note. You can also use the **ip slb server ip cluster** command to administratively disable or enable a server (see “Taking a Server On/Off Line” on page 25-17).

Assigning a Server to an SLB Cluster

You assign physical servers to an existing logical SLB cluster with the **ip slb server ip cluster** command by entering **ip slb server ip**, the IP address of the server in dotted decimal format, **cluster**, and the name of the SLB cluster.

For example, to assign a server with an IP address of 10.105.16.118 to an SLB cluster called “Web_Server”, you would enter:

```
-> ip slb server ip 10.105.16.118 cluster Web_Server
```

For example, to assign three physical servers with IP addresses of 10.105.16.121, 10.105.16.122, and 10.105.16.123, respectively, to an SLB cluster called “Web_Server”, enter the following CLI commands:

```
-> ip slb server ip 10.105.16.121 cluster Web_Server
-> ip slb server ip 10.105.16.122 cluster Web_Server
-> ip slb server ip 10.105.16.123 cluster Web_Server
```

Removing a Server from an SLB Cluster

To remove a physical server from an SLB cluster, use the **no** form of the **ip slb server ip cluster** command by entering **no ip slb server ip**, the IP address of the server you want to remove in dotted decimal format, **cluster**, and the name of the SLB cluster.

For example, to remove a server with an IP address of 10.105.16.121 from an SLB cluster called “Web_Server” you would enter:

```
-> no ip slb server ip 10.105.16.121 cluster Web_Server
```

Modifying Optional Parameters

As shown in the table on [page 25-3](#), Alcatel-Lucent's SLB software is preconfigured with default values for the SLB cluster's "sticky" time, ping timeout, ping period, ping retries, and relative weight (preference). The following subsections describe how to modify these parameters.

- **Modifying the Ping Period.** You can modify the ping period with the **ip slb cluster ping period** command, which is described in "Modifying the Ping Period" on [page 25-15](#).
- **Modifying the Ping Timeout.** You can modify the ping timeout with the **ip slb cluster ping timeout** command, which is described in "Modifying the Ping Timeout" on [page 25-15](#).
- **Modifying the Number of Ping Retries.** You can modify the number of ping retries with the **ip slb cluster ping retries** command, which is described in "Modifying the Ping Retries" on [page 25-16](#).
- **Modifying the Relative Weight of an SLB Cluster Server.** You can configure server preferences within a cluster by modifying the relative weight of each server with the **ip slb server ip cluster** command, which is described in "Modifying the Relative Weight of a Physical Server" on [page 25-16](#).

Modifying the Ping Period

You can modify this value with the **ip slb cluster ping period** command by entering **ip slb cluster**, the name of the SLB cluster, **ping period**, and the user-specified number of seconds. For default and range of values for the parameters, check the "Server Load Balancing Specifications" on [page 25-2](#) and "Server Load Balancing Default Values" on [page 25-3](#) tables.

For example, to set the ping period on an SLB cluster called "Web_Server" to 1200 seconds enter:

```
-> ip slb cluster Web_Server ping period 120
```

Note. If you set the ping period to any value other than 0, then the ping period must be greater than or equal to the ping timeout value divided by 1000. For example, if the ping timeout is 5000 milliseconds, the ping period must be at least 5 seconds. The ping timeout value can be modified with the **ip slb cluster ping timeout** command, which is described in "Modifying the Ping Timeout" on [page 25-15](#).

Modifying the Ping Timeout

You can modify the value of the ping period with the **ip slb cluster ping timeout** command by entering **ip slb cluster**, the name of the SLB cluster, **ping timeout**, and the user-specified number of milliseconds.

For example to set the ping timeout on an SLB cluster called "Web_Server" to 1000 milliseconds enter:

```
-> ip slb cluster Web_Server ping timeout 1000
```

Note. You can modify the ping period with the **ip slb cluster ping period** command, which is described in "Modifying the Ping Period" on [page 25-15](#).

Modifying the Ping Retries

You can modify the ping retry value with the **ip slb cluster ping retries** command by entering **ip slb cluster**, the name of the SLB cluster, **ping retries**, and the user-specified number of ping retries. For example:

```
-> ip slb cluster Web_Server ping retries 5
```

Modifying the Relative Weight of a Physical Server

To modify the relative weight of a server, use the **ip slb server ip cluster** command by entering **ip slb server**, the IP address of the physical server you want to modify, **cluster**, the name of the SLB cluster to which this server belongs, **weight**, and the value for the relative weight, (the switch prevents the physical server from being assigned any new connections), with 32 having the greatest relative weight.

For example, to set the relative weight of a server with an IP address of 10.105.16.121 that belongs to an SLB cluster called “Web_Server” to 5 enter:

```
-> ip slb server ip 10.105.16.121 cluster Web_Server weight 5
```

Server weights are relative. For example, if Servers A and B have respective weights of 5 and 10 within a cluster, Server A would get half the traffic of server B. Since weights are relative, assigning Servers A and B respective weights of 1 and 2, or 5 and 10, etc., would produce identical results.

Note. The **ip slb server ip cluster** command is also used to add or remove servers from an SLB cluster (see [“Assigning Servers to and Removing Servers from a Cluster” on page 25-14](#)) and for administratively enabling and disabling a server in an SLB cluster (see [“Taking a Server On/Off Line” on page 25-17](#)).

Configuring a Server in an SLB Cluster as a Backup Server

You can configure a server in a cluster as a backup server with the **ip slb server ip cluster weight** command by entering **ip slb server ip**, the IP address of the server, **cluster**, the name of the SLB cluster, **weight** and weight value as zero.

For example, to configure a server with an IP address of 10.105.16.118 in an SLB cluster called “Web_Server” as a backup server, enter:

```
-> ip slb server ip 10.105.16.118 cluster Web_Server weight 0
```

Assigning a weight of 0 (zero) to a server prevents this server from being assigned any new connections. This server becomes a backup server.

Taking Clusters and Servers On/Off Line

Alcatel-Lucent's Server Load Balancing (SLB) **show** commands provide tools to monitor traffic and troubleshoot problems. These commands are described in [“Displaying Server Load Balancing Status and Statistics” on page 25-22](#). If problems are identified, you can use the **ip slb cluster admin-state** command to administratively disable an entire SLB cluster or the **ip slb server ip cluster** command to administratively disable individual servers within an SLB cluster. These commands are described in the following sections.

Taking a Cluster On/Off Line

The following subsections describe how to bring an SLB cluster on line and how to take it off line with the **ip slb cluster admin-state** command.

Bringing an SLB Cluster On Line

You can bring an administratively disabled SLB cluster on line with the **ip slb cluster admin-state** command by entering **ip slb cluster**, the name of the SLB cluster, and **admin-state enable**.

For example, to bring an SLB cluster called “WorldWideWeb” on line, you would enter:

```
-> ip slb cluster WorldWideWeb admin-state enable
```

Taking an SLB Cluster Off Line

You can take a Server Load Balancing (SLB) cluster off line with the **ip slb cluster admin-state** command by entering **ip slb cluster**, the name of the SLB cluster, and **admin-state disable**.

For example, to take an SLB cluster called “WorldWideWeb” off line, you would enter:

```
-> ip slb cluster WorldWideWeb admin-state disable
```

Taking a Server On/Off Line

The following subsections describe how to bring a physical server on line and how to take it off line with the **ip slb server ip cluster** command.

Note. The **ip slb server ip cluster** command is also used to add or remove physical servers from an SLB cluster (see [“Assigning Servers to and Removing Servers from a Cluster” on page 25-14](#)).

Bringing a Server On Line

You bring an administratively disabled server in an SLB cluster on line with the **ip slb server ip cluster** command by entering **ip slb server**, the IP address of the server you want to enable in dotted decimal format, **cluster**, the name of the SLB cluster to which the server belongs, and **admin-state enable**.

For example, to administratively enable a server with an IP address of 10.105.16.121 that belongs to an SLB cluster called “Web_Server”, you would enter:

```
-> ip slb server ip 10.105.16.121 cluster Web_Server admin-state enable
```

Taking a Server Off Line

You can administratively disable a server in an SLB cluster and take it off line with the **ip slb server ip cluster** command by entering **ip slb server**, the IP address of the server you want to disable in dotted decimal format, **cluster**, the name of the SLB cluster to which the server belongs, and **admin-state disable**.

For example, to administratively disable a server with an IP address of 10.105.16.123 that belongs to an SLB cluster called “Web_Server”, you would enter:

```
-> ip slb server ip 10.105.16.123 cluster Web_Server admin-state disable
```

Configuring SLB Probes

Server Load Balancing (SLB) probes allow you to check the health of logical clusters and physical servers. Supported features include:

- Support for server health monitoring using Ethernet link state detection
- Support for server health monitoring using IPv4 ICMP ping
- Support for server health monitoring using a Content Verification Probe

Creating SLB Probes

To create an SLB probe use the **ip slb probe** command by entering the command followed by the user-configured probe name and the probe type, which can be any one of the following listed in the table below:

ip slb probe keywords

ftp	http	https
imap	imaps	nntp
ping	pop	pops
smtp	tcp	udp

For example, to create an HTTP SLB probe called “server_probe1”, enter:

```
-> ip slb probe server_probe1 http
```

You can configure up to 20 probes on a switch.

Deleting SLB Probes

To delete an SLB use the **no** form of the **ip slb probe** command by entering **no ip slb probe** followed by the probe name. For example, to delete an SLB probe called “server_probe1”, enter:

```
-> no ip slb probe server_probe1
```

Associating a Probe with a Cluster

To associate an existing SLB probe with a cluster use the **ip slb cluster probe** command by entering **ip slb cluster** followed by the user-configured cluster name, **probe**, and the user-configured probe name.

For example, to associate a probe called “cluster_probe1” with a cluster called “WorldWideWeb”, enter:

```
-> ip slb cluster WorldWideWeb probe cluster_probe1
```

Associating a Probe with a Server

To associate an existing SLB probe with a server use the **ip slb server ip cluster probe** command by entering **ip slb server ip** followed by IP address of the server, **cluster**, the user-configured cluster name, **probe**, and the user-configured probe name.

For example, to associate a probe called “server_probe1” with a server with an IP address of 10.255.11.127 that belongs to a cluster called “WorldWideWeb”, enter:

```
-> ip slb server ip 10.255.11.127 cluster WorldWideWeb probe server_probe1
```

Modifying SLB Probes

The following subsections describe how to modify existing SLB probes.

Modifying the Probe Timeout

To modify this value, use the **ip slb probe timeout** command by entering **ip slb probe** followed by the user-configured probe name, the probe type, **timeout**, and the user-specified timeout value.

Note. See “[Creating SLB Probes](#)” on page 25-18 for a list of valid probe types.

For example, to set the timeout for an HTTP SLB probe called “server_probe1” to 12000 seconds, enter:

```
-> ip slb probe server_probe1 http timeout 12000
```

Modifying the Probe Period

To modify this value, use the **ip slb probe period** command by entering **ip slb probe** followed by the user-configured probe name, the probe type, **period**, and the user-specified period value.

Note. See “[Creating SLB Probes](#)” on page 25-18 for a list of valid probe types.

For example, to set the period for an HTTP SLB probe called “server_probe1” to 120 seconds, enter:

```
-> ip slb probe server_probe1 http period 120
```

Modifying the Probe TCP/UDP Port

To modify this value, use the **ip slb probe port** command by entering **ip slb probe** followed by the user-configured probe name, the probe type, **port**, and the user-specified port number.

Note. See “Creating SLB Probes” on page 25-18 for a list of valid probe types.

For example, to set the TCP/UDP port for an HTTP SLB probe called “server_probe1” to 200 enter:

```
-> ip slb probe server_probe1 http port 200
```

Modifying the Probe Retries

By default, the number of SLB probe retries before deciding that a server is out of service is 3. To modify this value from 0 to 255 use the **ip slb probe retries** command by entering **ip slb probe** followed by the user-configured probe name, the probe type, **retries**, and the user-specified number of retries.

Note. See “Creating SLB Probes” on page 25-18 for a list of valid probe types.

For example, to set the number of retries for an HTTP SLB probe called “server_probe1” to 10, enter:

```
-> ip slb probe server_probe1 http retries 10
```

Configuring a Probe User Name

To configure a user name sent to a server as credentials for an HTTP GET operation to verify the health of the server use the **ip slb probe username** command by entering **ip slb probe** followed by the user-configured probe name, either **http** or **https**, **username**, and the user-specified user name.

For example, to set the user name for an HTTP SLB probe called “server_probe1” to “subnet1”, enter:

```
-> ip slb probe server_probe1 http username subnet1
```

Configuring a Probe Password

To configure a password sent to a server as credentials for an HTTP GET to verify the health of the server use the **ip slb probe password** command by entering **ip slb probe** followed by the user-configured probe name, either **http** or **https**, **password**, and the user-specified password.

For example, to set the password for an HTTP SLB probe called “server_probe1” to “h1f45xc” enter:

```
-> ip slb probe server_probe1 http password h1f45xc
```

Configuring a Probe URL

To configure a URL sent to a server for an HTTP GET to verify the health of the server use the **ip slb probe url** command by entering **ip slb probe** followed by the user-configured probe name, either **http** or **https**, **url**, and the user-specified URL.

Note. The URL must be the relative web page name to be retrieved.

For example, to set the URL for an HTTP SLB probe called “server_probe1” to “pub/index.html”, enter:

```
-> ip slb probe server_probe1 http url pub/index.html
```

Modifying the Probe Status

To modify this value, use the **ip slb probe status** command by entering **ip slb probe** followed by the user-configured probe name, either **http** or **https**, **status**, and the user-specified expected status.

For example, to set the expected status for an HTTP SLB probe called “server_probe1” to 404, enter:

```
-> ip slb probe server_probe1 http status 404
```

Configuring a Probe Send

To configure an ASCII string sent to a server to invoke a response from it and to verify its health use the **ip slb probe send** command by entering **ip slb probe** followed by the user-configured probe name, the valid probe type (**udp** or **tcp**), **send**, and the user-specified ASCII string.

For example, to set the TCP/UDP port for an TCP SLB probe called “server_probe1” to “test”, enter:

```
-> ip slb probe server_probe1 tcp send test
```

Configuring a Probe Expect

To configure an ASCII string used to compare a response from a server to verify the health of the server use the **ip slb probe expect** command by entering **ip slb probe** followed by the user-configured probe name, the valid probe type (**http**, **https**, **udp**, or **tcp**), **expect**, and the user-specified ASCII string.

For example, to set the TCP/UDP port for an HTTP SLB probe called “server_probe1” to “test”, enter:

```
-> ip slb probe server_probe1 http expect test
```

Displaying Server Load Balancing Status and Statistics

You can use CLI **show** commands to display the current configuration and statistics of Server Load Balancing on a switch. These commands include the following:

show ip slb	Displays the status of server load balancing on a switch.
show ip slb servers	Displays the status of all the physical servers belonging to server load balancing clusters on a switch.
show ip slb clusters	Displays the status and configuration of all server load balancing clusters on a switch. Also displays traffic statistics for all condition clusters.
show ip slb cluster	Displays detailed status and configuration information for a single server load balancing cluster on a switch. Also displays traffic statistics for a single condition cluster.
show ip slb cluster server	Displays detailed status and configuration information for a single physical server in a server load balancing cluster.
show ip slb probes	Display the configuration of Server Load Balancing (SLB) probes.

The **show ip slb**, **show ip slb servers**, and **show ip slb clusters** commands provide a “global” view of switch-wide SLB parameters. These commands are particularly helpful in fine-tuning configurations. For example, if you wanted to get a quick look at the status of all SLB clusters you would use the **show ip slb clusters** command as shown below:

```
-> show ip slb clusters
```

Cluster Name	VIP/COND	Admin Status	Operational Status	# Srv	% Avail
WorldWideWeb	128.241.130.204	Enabled	In Service	3	95
Intranet	128.241.130.210	Enabled	In Service	2	100
FileTransfer	128.241.130.206	Enabled	Out of Service	2	50

In the example above, two SLB clusters (“WorldWideWeb” and “Intranet”) are administratively enabled and are “in service” (at least one physical server is operational in the cluster). The third SLB cluster (“FileTransfer”) is administratively enabled but is “out of service” (no physical servers are operational in the cluster).

The **show ip slb cluster** command provides detailed configuration information and statistics for individual SLB clusters. To use the **show ip slb cluster** command, enter the command followed by the name of the SLB cluster, as shown below:

```
-> show ip slb cluster WorldWideWeb
```

A **statistics** parameter is available with both the **show ip slb clusters** and **show ip slb cluster** commands to provide a packet count of traffic that was qualified and sent to a QoS policy condition cluster. To use this parameter, enter either of these commands with their required parameters and optionally specify the statistics parameter, as shown below:

```
-> show ip slb clusters statistics
-> show ip slb cluster Intranet statistics
```

Note. See [page 25-4](#) and [page 25-6](#) for samples of the **show ip slb cluster** command output.

The **show ip slb cluster server** command provides detailed configuration information and statistics for individual SLB servers. To use the **show ip slb cluster server** command, enter the command, the name of the SLB cluster that the server belongs to, **server**, and the IP address of the server. For example, to display statistics and parameters for a server with an IP address of 10.123.11.14 that belongs to an SLB cluster called “Web_Server” you would enter:

```
-> show ip slb cluster Web_Server server 10.123.11.14
```

A screen similar to the following is displayed:

```
Cluster Web_Server
VIP: 10.123.11.14
  Server 10.123.11.4
    Admin weight           = 3,
    Admin status           : Enabled,
    Oper status            : In Service,
    Availability time (%)  = 95,
    Ping failures          = 0,
    Last ping round trip time (milliseconds)= 20,
    Probe status           = OK
```

In the example above, the server with an IP address of 10.123.11.4 is shown to be administratively enabled and “in service” (this means that, this server is being used for SLB cluster client connections) with the administrative weight assigned as 3.

The **show ip slb probes** command provides both a global view of SLB probes and a detailed configuration information and statistics for individual probes. For example, to view the status of all probes enter show ip slb probes as shown below:

```
-> show ip slb probes
```

Probe Name	Period	Retries	Timeout	Method
web_server	60000	3	12000	HTTP
mail_server	60000	3	3000	SMTP
mis_servers	3600000	5	24000	Ping

In the example above there are three probes configured on the switch.

To view detailed information on a single probe enter **show ip slb probes** followed by the probe name as shown in the example below:

```
-> show ip slb probes phttp
Probe phttp
  Type           = HTTP,
  Period (seconds) = 60,
  Timeout (milliseconds) = 3000,
  Retries        = 3,
  Port           = 0,
  Username       = ,
  Password       = ,
  Expect        = ,
  Status        = 200,
  URL           = /,
```

Note. See the “Server Load Balancing Commands” chapter in the *OmniSwitch AOS Release 8 CLI Reference Guide* for complete syntax information on SLB **show** commands.

26 Configuring IP Multicast Switching

IP Multicast Switching is a one-to-many communication technique employed by emerging applications, such as video distribution, news feeds, conferencing, netcasting, and resource discovery (OSPF, RIP2, and BOOTP). Unlike unicast, which sends one packet per destination, multicast sends one packet to all devices in any subnetwork that has at least one device requesting the multicast traffic. Multicast switching also requires much less bandwidth than unicast techniques and broadcast techniques, since the source hosts only send one data stream to the ports on which destination hosts that request it are attached.

Destination hosts signal their intent to receive a specific IP multicast stream by sending a request to do so to a nearby switch by using Internet Group Management Protocol (IGMP). This is referred to as IGMP Snooping. Destination hosts signal their intent to receive a specific IPv6 multicast stream by sending a request to do so to a nearby switch by using Multicast listener discovery protocol (MLD). This is referred to as MLD Snooping. The switch then learns on which ports multicast group subscribers are attached and can intelligently deliver traffic only to the respective ports. Alcatel-Lucent's implementation of IGMP snooping is called IP Multicast Switching (IPMS) and MLD snooping is called IP Multicast Switching version 6 (IPMSv6). IPMS/IPMSv6 allows switches to efficiently deliver multicast traffic in hardware at wire speed.

In This Chapter

This chapter describes the basic components of IPMS and how to configure them through the Command Line Interface (CLI). CLI commands are used in the configuration examples; for more details about the syntax of commands, see the *OmniSwitch AOS Release 8 CLI Reference Guide*.

Configuration procedures described in this chapter include:

- Enabling and disabling IP Multicast Switching and Routing on [page 26-9](#).
- Configuring and removing an IGMP static neighbor on [page 26-11](#).
- Configuring and removing an IGMP static querier on [page 26-12](#).
- Configuring and removing an IGMP static group on [page 26-12](#).
- Enabling and disabling Initial Multicast Packet Buffering on [page 26-13](#).
- Modifying IPMS parameters beginning on [page 26-15](#).
- Enabling and disabling IPv6 Multicast Switching and Routing on [page 26-25](#).
- Configuring and removing an MLD static neighbor on [page 26-27](#).
- Configuring and removing an MLD static querier on [page 26-27](#).
- Configuring and removing an MLD static group on [page 26-28](#).

- Modifying IPMSv6 parameters beginning on [page 26-29](#).

Note. You can also configure and monitor IPMS with WebView, Alcatel-Lucent's embedded Web-based device management application. WebView is an interactive and easy-to-use GUI that can be launched from OmniVista or a Web browser. Please refer to WebView's online documentation for more information on configuring and monitoring IPMS/IPMSv6 with WebView.

IPMS Specifications

The table below lists specifications for Alcatel-Lucent's IPMS software.

Platforms Supported	OmniSwitch 6860, 6860E
RFCs Supported	RFC 1112 — Host Extensions for IP Multicasting RFC 2236 — Internet Group Management Protocol, Version 2 RFC 2710 -- Multicast Listener Discovery (MLD) for IPv6 RFC 2933 — Internet Group Management Protocol MIB RFC 3019 -- IP Version 6 Management Information Base for The Multicast Listener Discovery Protocol RFC 3376 -- Internet Group Management Protocol, Version 3 RFC 3810 — Multicast Listener Discovery Version 2 (MLDv2) for IPv6 RFC 4541 — Considerations for Internet Group Management Protocol (IGMP) and Multicast Listener Discovery (MLD) Snooping Switches RFC 4604 — Using Internet Group Management Protocol Version 3 (IGMPv3) and Multicast Listener Discovery Protocol Version 2 (MLDv2) for Source-Specific Multicast
IGMP Versions Supported	IGMPv1, IGMPv2, IGMPv3
Maximum number of IPv4 multicast flows	12K
Maximum number of IPv4 multicast forwarding entries	8K

IPMSv6 Specifications

The table below lists specifications for Alcatel-Lucent's IPMSv6 software.

RFCs Supported	RFC 2710 — Multicast Listener Discovery for IPv6 RFC 3019 — IPv6 MIB for Multicast Listener Discovery Protocol 3306—Unicast-Prefix-based IPv6 Multicast Addresses RFC 3810 — Multicast Listener Discovery Version 2 for IPv6 RFC 4541 - Considerations for Internet Group Management Protocol (IGMP) and Multicast Listener Discovery (MLD) Snooping Switches RFC 4604 - Using Internet Group Management Protocol Version 3 (IGMPv3) and Multicast Listener Discovery Protocol Version 2 (MLDv2) for Source-Specific Multicast
Platforms Supported	OmniSwitch 6860, 6860E
MLD Versions Supported	MLDv1, MLDv2
MLD Query Interval	1 to 65535 in seconds
MLD Router Timeout	1 to 65535 in seconds
MLD Source Timeout	1 to 65535 in seconds
MLD Query Response Interval	1 to 65535 in milliseconds
MLD Last Member Query Interval	1 to 65535 in milliseconds
Maximum number of IPv6 multicast flows	6K

IPMS Default Values

The table below lists default values for Alcatel-Lucent's IPMS software.

Parameter Description	Command	Default Value/Comments
Administrative Status	ip multicast admin-state	disabled
IGMP Querier Forwarding	ip multicast querier-forwarding	disabled
IGMP Version	ip multicast version	version 2
IGMP Query Interval	ip multicast query-interval	125 seconds
IGMP Last Member Query Interval	ip multicast last-member-query-interval	10 tenths-of-seconds
IGMP Query Response Interval	ip multicast query-response-interval	100 tenths-of-seconds
IGMP Router Timeout	ip multicast router-timeout	90 seconds
Source Timeout	ip multicast source-timeout	30 seconds

Parameter Description	Command	Default Value/Comments
IGMP Querying	ip multicast querying	disabled
IGMP Robustness	ip multicast robustness	2
IGMP Spoofing	ip multicast spoofing	disabled
IGMP Zapping	ip multicast zapping	disabled

IPMSv6 Default Values

The table below lists default values for Alcatel-Lucent's IPMSv6 software.

Parameter Description	Command	Default Value/Comments
Administrative Status	ip multicast helper-address	disabled
MLD Querier Forwarding	ipv6 multicast querier-forwarding	disabled
MLD Version	ipv6 multicast flood-unknown	version 1
MLD Query Interval	ipv6 multicast query-interval	125 seconds
MLD Last Member Query Interval	ipv6 multicast last-member-query-interval	1000 milliseconds
MLD Query Response Interval	ipv6 multicast query-response-interval	10000 milliseconds
MLD Router Timeout	ipv6 multicast router-timeout	90 seconds
Source Timeout	ipv6 multicast source-timeout	30 seconds
MLD Querying	ipv6 multicast querying	disabled
MLD Robustness	ipv6 multicast robustness	2
MLD Spoofing	ipv6 multicast spoofing	disabled
MLD Zapping	ipv6 multicast zapping	disabled

IPMS Overview

A multicast group is defined by a multicast group address, which is a Class D IP address in the range 224.0.0.0 to 239.255.255.255. (Addresses in the range 239.0.0.0 to 239.255.255.255 are reserved for boundaries.) The multicast group address is indicated in the destination address field of the IP header. (See [“Reserved IP Multicast Addresses”](#) on page 26-7 for more information.)

IPMS tracks the source VLAN on which the Internet Group Management Protocol (IGMP) requests are received. The network interfaces verify that a multicast packet is received by the switch on the source (or expected) port.

IPMS Example

The figure on the following page shows an IPMS network where video content can be provided to clients that request it. A server is attached to the switch that provides the source (i.e., multicast) IP addresses. Clients from two different attached networks send IGMP reports to the switch to receive the video content.

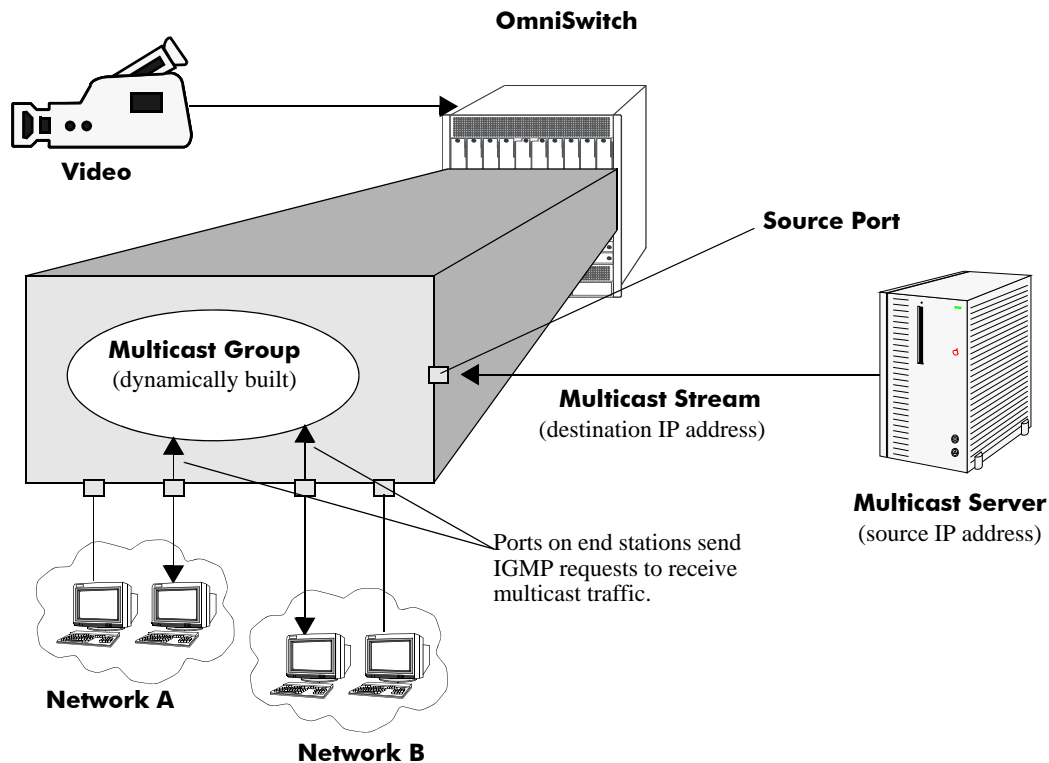

Reserved IP Multicast Addresses

The Internet Assigned Numbers Authority (IANA) created the range for multicast addresses, which is 224.0.0.0 to 239.255.255.255. However, as the table below shows, certain addresses are reserved and cannot be used.

Address or Address Range	Description
224.0.0.0 through 224.0.0.255	Routing protocols (for example, OSPF, RIP2)
224.0.1.0 through 224.0.1.255	Internetwork Control Block (for example, RSVP, DHCP, commercial servers)
224.0.2.0 through 224.0.255.0	AD-HOC Block (for example, commercial servers)
224.1.0.0 through 224.1.255.255	ST Multicast Groups
224.2.0.0 through 224.2.255.255	SDP/SAP Block
224.252.0.0 through 224.255.255.255	DIS Transient Groups
225.0.0.0 through 231.255.255.255	Reserved
232.0.0.0 through 232.255.255.255	Source Specific Multicast
233.0.0.0 through 233.255.255.255	GLOP Block
234.0.0.0 through 238.255.255.255	Reserved
239.0.0.0 through 239.255.255.255	Administratively Scoped

IP Multicast Routing

IP multicast routing can be used for IP Multicast Switching and Routing (IPMSR). IP multicast routing is a way of controlling multicast traffic across networks. The IP multicast router discovers which networks want to receive multicast traffic by sending out Internet Group Management Protocol (IGMP) queries and receiving IGMP reports from attached networks. The IGMP reports signal that users want to join a multicast group.

If there is more than one IP multicast router in the network, the router with the lowest IP address is elected as the querier router, which is responsible for querying the subnetwork for group members.

The IP multicast routing package provides the following two separate protocols:

- Protocol Independent Multicast — Sparse Mode (PIM-SM) and Dense Mode (PIM-DM), which is described in [“PIM” on page 26-8](#).
- Distance Vector Multicast Routing Protocol (DVMRP), which is described in [“DVMRP” on page 26-8](#).

The multicast routing protocols build and maintain a multicast routing database. The multicast routing protocols forward multicast traffic to *networks* that have requested group membership to a specific multicast group. IPMS uses decisions made by the routing protocols and forwards multicast traffic to *ports* that request group membership. See the *OmniSwitch AOS Release 8 Advanced Routing Configuration Guide* for more information on IP multicast routing protocols.

PIM

Protocol-Independent Multicast (PIM) is an IP multicast routing protocol that uses routing information provided by unicast routing protocols, such as RIP and OSPF. Sparse Mode PIM (PIM-SM) contrasts with flood-and-prune dense mode multicast protocols, such as DVMRP and PIM Dense Mode (PIM-DM), in that multicast forwarding in PIM-SM is initiated only through specific requests. Downstream routers must explicitly join PIM-SM distribution trees in order to receive multicast streams on behalf of directly-connected receivers or other downstream PIM-SM routers. This paradigm of receiver-initiated forwarding makes PIM-SM ideal for network environments where receiver groups are thinly populated and bandwidth conservation is a concern, such as in Wide Area Networks (WANs). PIM-DM packets are transmitted on the same socket as PIM-SM packets as both use the same protocol and message format. Unlike PIM-SM, in PIM-DM there are no periodic joins transmitted; only explicitly triggered prunes and grafts. In PIM-DM, unlike PIM-SM, there is no Rendezvous Point (RP).

DVMRP

Distance Vector Multicast Routing Protocol (DVMRP) is a distributed multicast routing protocol that dynamically generates per-source delivery trees based upon routing exchanges. When a multicast source begins to transmit, the multicast data is flooded down the delivery tree to all points in the network. DVMRP then *prunes* (i.e., removes branches from) the delivery tree where the traffic is unwanted. This is in contrast to PIM-SM, which uses receiver-initiated (i.e., forward path) multicasting.

IGMP Version 3

IGMP is used by IPv4 systems (hosts and routers) to report their IP multicast group memberships to any neighboring multicast routers. IGMP Version 2 (IGMPv2) handles forwarding by IP multicast destination address only. IGMP Version 3 (IGMPv3) handles forwarding by source IP address and IP multicast destination address. All three versions (IGMPv1, IGMPv2, and IGMPv3) are supported.

Note. See [“Configuring the IGMP Version” on page 26-11](#) for information on configuring the IGMP version.

In IGMPv2, each membership report contains only one multicast group. In IGMPv3, membership reports contain many multicast groups up to the Maximum Transmission Unit (MTU) size of the interface. IGMPv3 uses source filtering and reports multicast memberships to neighboring routers by sending membership reports. IGMPv3 also supports Source Specific Multicast (SSM) by allowing hosts to report interest in receiving packets only from specific source addresses or from all but specific source addresses.

Configuring IPMS on a Switch

This section describes how to use Command Line Interface (CLI) commands to enable and disable IP Multicast Switching and Routing (IPMSR) switch wide (see “[Enabling and Disabling IP Multicast Status](#)” on page 26-9), configure a port as a IGMP static neighbor (see “[Configuring and Removing an IGMP Static Neighbor](#)” on page 26-11), configure a port as a IGMP static querier (see “[Configuring and Removing an IGMP Static Querier](#)” on page 26-12), and configure a port as a IGMP static group (see “[Configuring and Removing an IGMP Static Group](#)” on page 26-12).

In addition, a tutorial is provided in “[IPMS Application Example](#)” on page 26-37 that shows how to use CLI commands to configure a sample network.

Note. See the “IP Multicast Switching Commands” chapter in the *OmniSwitch AOS Release 8 CLI Reference Guide* for complete documentation of IPMS CLI commands.

Enabling and Disabling IP Multicast Status

IP Multicast Switching and Routing is disabled by default on a switch. The following subsections describe how to enable and disable IP Multicast Switching and Routing with the **ip multicast admin-state** command.

Note. See If IP Multicast switching and routing is enabled on the system, the VLAN configuration overrides the configuration of the system.

Enabling IP Multicast Status

To enable IP Multicast switching and routing on the system if no VLAN is specified, use the **ip multicast admin-state** command as shown below:

```
-> ip multicast admin-state enable
```

You can also enable IP Multicast switching and routing on the specified VLAN by entering:

```
-> ip multicast vlan 2 admin-state enable
```

Disabling IP Multicast Status

To disable IP Multicast switching and routing on the system if no VLAN is specified, use the **ip multicast admin-state** command as shown below:

```
-> ip multicast admin-state disable
```

Or, as an alternative, enter:

```
-> ip multicast admin-state
```

To restore the IP Multicast status to its default setting.

You can also disable IP Multicast switching and routing on the specified VLAN by entering:

```
-> ip multicast vlan 2 admin-state disable
```

Or, as an alternative, enter:

```
-> ip multicast vlan 2 admin-state
```

To restore the IP Multicast status to its default setting.

Enabling and Disabling IGMP Querier-forwarding

By default, IGMP querier-forwarding is disabled. The following subsections describe how to enable and disable IGMP querier-forwarding by using the **ip multicast querier-forwarding** command.

Enabling the IGMP Querier-forwarding

You can enable the IGMP querier-forwarding by entering **ip multicast querier-forwarding** followed by the **enable** keyword. For example, to enable the IGMP querier-forwarding on the system if no VLAN is specified, you would enter:

```
-> ip multicast querier-forwarding enable
```

You can also enable the IGMP querier-forwarding on the specified VLAN by entering:

```
-> ip multicast vlan 2 querier-forwarding enable
```

Disabling the IGMP Querier-forwarding

You can disable the IGMP querier-forwarding by entering **ip multicast querier-forwarding** followed by the **disable** keyword. For example, to disable the IGMP querier-forwarding on the system if no VLAN is specified, you would enter:

```
-> ip multicast querier-forwarding disable
```

Or, as an alternative, enter:

```
-> ip multicast querier-forwarding
```

To restore the IGMP querier-forwarding to its default setting.

You can also disable the IGMP querier-forwarding on the specified VLAN by entering:

```
-> ip multicast vlan 2 querier-forwarding disable
```

Or, as an alternative, enter:

```
-> ip multicast vlan 2 querier-forwarding
```

To restore the IGMP querier-forwarding to its default setting.

You can remove an IGMP querier-forwarding entry on the specified VLAN and return to its default behavior by entering:

```
-> no ip multicast vlan 2 querier-forwarding
```

Configuring and Restoring the IGMP Version

By default, the version of Internet Group Management Protocol (IGMP) membership is Version 2. The following subsections describe how to configure IGMP protocol version ranging from 1 to 3 with the **ip multicast version** command.

Configuring the IGMP Version

To change the IGMP protocol version on the system if no VLAN is specified, use the **ip multicast version** command as shown below:

```
-> ip multicast version 3
```

You can also change the IGMP protocol version on the specified VLAN by entering:

```
-> ip multicast vlan 5 version 1
```

Restoring the IGMP Version

To restore the IGMP protocol version to its default version on the system if no VLAN is specified, use the **ip multicast version** command as shown below:

```
-> ip multicast version 0
```

Or, as an alternative, enter:

```
-> ip multicast version
```

To restore the IGMP version to its default version.

You can also restore the IGMP protocol version to version 2 on the specified VLAN by entering:

```
-> ip multicast vlan 2 version 0
```

Or, as an alternative, enter:

```
-> ip multicast vlan 2 version
```

To restore the IGMP version to its default version.

Configuring and Removing an IGMP Static Neighbor

IGMP static neighbor ports receive all multicast streams on the designated VLAN and also receive IGMP reports for the VLAN. The following subsections describe how to configure and remove a IGMP static neighbor port by using the **ip multicast static-neighbor** command.

Configuring an IGMP Static Neighbor

You can configure a port as an IGMP static neighbor port by entering **ip multicast static-neighbor** followed by the VLAN and port.

For example, to configure port 1/1/10 with designated VLAN 2 as an IGMP static neighbor you would enter:

```
-> ip multicast static-neighbor vlan 2 port 1/1/10
```

You can also configure a link aggregation group as an IGMP static neighbor port by entering **ip multicast static-neighbor** followed by the VLAN and link aggregation group number.

For example, to configure link aggregation group 7 with designated VLAN 2 as a static neighbor you would enter:

```
-> ip multicast static-neighbor vlan 2 linkagg 7
```

Removing an IGMP Static Neighbor

To reset the port so that it is no longer an IGMP static neighbor port, use the **no** form of the **ip multicast static-neighbor** command. For example:

```
-> no ip multicast static-neighbor vlan 2 port 1/1/10
```

Configuring and Removing an IGMP Static Querier

IGMP static querier ports receive IGMP reports generated on the designated VLAN. Unlike IPMS neighbor ports, they do not receive all multicast streams. The following subsections describe how to configure and remove a static querier by using the **ip multicast static-querier** command.

Configuring an IGMP Static Querier

You can configure a port as an IGMP static querier port by entering **ip multicast static-querier**, followed by the VLAN and port. For example:

```
-> ip multicast static-querier vlan 2 port 1/1/10
```

You can also configure a link aggregation group as an IGMP static querier port by entering **ip multicast static-querier** followed by the VLAN and link aggregate. For example:.

```
-> ip multicast static-querier vlan 2 linkagg 7
```

Removing an IGMP Static Querier

To reset the port so that it is no longer an IGMP static querier port, use the **no** form of the **ip multicast static-querier** command. For example:

```
-> no ip multicast static-querier vlan 2 port 1/1/10
```

Configuring and Removing an IGMP Static Group

IGMP static group ports receive all multicast streams (or data) from the specific group. The following subsections describe how to configure and remove a static group with the **ip multicast static-group** command.

Configuring an IGMP Static Group

You can configure a port as an IGMP static group by entering **ip multicast static-group**, followed by the VLAN and port. For example:

```
-> ip multicast static-group 225.0.0.1 vlan 3 port 1/1/10
```

You can also configure a link aggregation group as an IPMS static group by entering **ip multicast static-group**, followed by the VLAN and link aggregate. For example:

```
-> ip multicast static-group 225.0.0.2 vlan 2 linkagg 7
```

Removing an IGMP Static Group

To reset the port so that it is no longer an IGMP static group port, use the **no** form of the **ip multicast static-group** command. For example:

```
-> no ip multicast static-group 225.0.0.1 vlan 3 port 1/1/10
```

Initial Multicast Packet Buffering

Multicast is often used for audio/video streaming applications, where the first packet is dropped as it is used for learning the new flow. However, if multicast is used for signaling applications, the initial packets sent by the multicast source are important. The packet buffering functionality can be enabled to prevent loss of first multicast packets in a routing environment.

Enabling Packet Buffering

To enable buffering of IPv4 and IPv6 initial multicast packets and support first packet routing, use the **ip multicast initial-packet-buffer admin-state** and **ipv6 multicast initial-packet-buffer admin-state** commands, respectively.

For example,

```
-> ip multicast initial-packet-buffer admin-state enable
-> ipv6 multicast initial-packet-buffer admin-state enable
```

All the initial multicast packets sent by the multicast source are buffered. The following are the limitations:

- In a given instance, the IPMS system can buffer only a configurable number of multicast packets per flow that are trapped to the IPMS software for learning the multicast flow. If the number of packets buffered for a given flow reaches the maximum configured limit, then the IPMS system will not buffer any new multicast packets for that flow. The maximum number of initial multicast packets allowed to be buffered per multicast flow is configured using **ip multicast initial-packet-buffer max-packet** and **ipv6 multicast initial-packet-buffer max-packet** for IPv4 and IPv6, respectively.

For example:

```
-> ip multicast initial-packet-buffer max-packet 4
-> ipv6 multicast initial-packet-buffer max-packet 4
```

- In a given instance, the IPMS system can buffer initial multicast packets only for a configurable number of flows globally on the switch. If the number of flows that are being buffered reaches the maximum configured limit, then the IPMS will not buffer initial multicast packets for any new flows in the system. The maximum number of IPv4 and IPv6 multicast flows allowed for initial packet buffering is configured using **ip multicast initial-packet-buffer max-flow** and **ipv6 multicast initial-packet-buffer max-flow**, respectively.

For example:

```
-> ip multicast initial-packet-buffer max-flow 32
-> ipv6 multicast initial-packet-buffer max-flow 32
```

- The buffered initial multicast packets for a flow will not be retained in the IPMS system forever. If the buffered packets are not sent to the destination (multicast clients) within a specified time, then the buffered packets will be dropped in the IPMS system. The timeout value for the initial buffered IPv4 and IPv6 multicast packets is configured using **ip multicast initial-packet-buffer timeout** and **ipv6 multicast initial-packet-buffer timeout**, respectively.

For example:

```
-> ip multicast initial-packet-buffer timeout 2
-> ipv6 multicast initial-packet-buffer timeout 2
```

- There may be loss of a few initial multicast packets while programming the IPMS index and sending buffered packets;
 - When the multicast routing protocol has greater than 255 interfaces - In a given instance, if there are more than 255 interfaces, the IPMS system will initially send the buffered multicast packets to the clients connected to a maximum of 255 interfaces. Then the remaining route information will be processed. However, the IPMS system begins communicating with the NI without waiting for complete route information. This may cause a loss of buffered packets to the remaining interfaces.
 - When ingress and egress are on the same VLAN - In any instance, if local clients are present in the ingress VLAN, the IPMS system will immediately generate an IPMS index for the switching port and will send the buffered packets. However, there is a delay in receiving the response from the routed clients. This may cause a loss of buffered packets for the routed clients.

These limitations are overcome by delaying the IPMS index generation in the IPMS system. This delay is configured using **ip multicast initial-packet-buffer min-delay** and **ipv6 multicast initial-packet-buffer min-delay** for IPv4 and IPv6 multicast packets, respectively.

```
-> ip multicast initial-packet-buffer min-delay 200
```

```
-> ipv6 multicast initial-packet-buffer min-delay 200
```

- Flood-unknown and buffer packet features are mutually exclusive. Flood-unknown must be disabled for the packet buffering feature to function. Use **ip multicast flood-unknown** and **ipv6 multicast flood-unknown** commands to disable the flood-unknown feature for IPv4 and IPv6 multicast flow, respectively.

For example:

```
-> ip multicast flood-unknown disable
```

```
-> ipv6 multicast flood-unknown disable
```

- Use **show configuration snapshot ipms**, **show ip multicast initial-packet-buffer** and **show ipv6 multicast initial-packet-buffer** commands to view the status of the packet buffering functionality.

Disabling Packet Buffering

To disable buffering of IPv4 initial multicast packets in the IPMS NI, use the following command. For example,

```
-> ip multicast initial-packet-buffer admin-state disable
```

To disable buffering of IPv6 initial multicast packets in the IPMS NI, use the following command. For example,

```
-> ipv6 multicast initial-packet-buffer admin-state disable
```

Modifying IPMS Parameters

The table in “[IPMS Default Values](#)” on page 26-3 lists default values for IPMS parameters. The following sections describe how to use CLI commands to modify these parameters.

Modifying the IGMP Query Interval

The default IGMP query interval (i.e., the time between IGMP queries) is 125 in seconds. The following subsections describe how to configure a user-specified query interval value and restore it with the **ip multicast query-interval** command.

Configuring the IGMP Query Interval

You can modify the IGMP query interval from 1 to 65535 in seconds by entering **ip multicast query-interval** followed by the new value. For example, to set the query interval to 60 seconds on the system if no VLAN is specified, you would enter:

```
-> ip multicast query-interval 60
```

You can also modify the IGMP query interval on the specified VLAN by entering:

```
-> ip multicast vlan 2 query-interval 60
```

Restoring the IGMP Query Interval

To restore the IGMP query interval to its default value on the system if no VLAN is specified, use the **ip multicast query-interval** command by entering:

```
-> ip multicast query-interval 0
```

Or, as an alternative, enter:

```
-> ip multicast query-interval
```

To restore the IGMP query interval to its default value.

You can also restore the IGMP query interval to its default value on the specified VLAN by entering:

```
-> ip multicast vlan 2 query-interval 0
```

Or, as an alternative, enter:

```
-> ip multicast vlan 2 query-interval
```

To restore the IGMP query interval to its default value.

Modifying the IGMP Last Member Query Interval

The default IGMP last member query interval (i.e., the time period to reply to an IGMP query message sent in response to a leave group message) is 10 in tenths of seconds. The following subsections describe how to configure the IGMP last member query interval and restore it by using the **ip multicast last-member-query-interval** command.

Configuring the IGMP Last Member Query Interval

You can modify the IGMP last member query interval from 1 to 65535 in tenths of seconds by entering **ip multicast last-member-query-interval** followed by the new value. For example, to set the IGMP last member query interval to 60 tenths-of-seconds on the system if no VLAN is specified, you would enter:

```
-> ip multicast last-member-query-interval 60
```

You can also modify the IGMP last member query interval on the specified VLAN by entering:

```
-> ip multicast vlan 3 last-member-query-interval 60
```

Restoring the IGMP Last Member Query Interval

To restore the IGMP last member query interval to its default value on the system if no VLAN is specified, use the **ip multicast last-member-query-interval** command by entering:

```
-> ip multicast last-member-query-interval 0
```

Or, as an alternative, enter:

```
-> ip multicast last-member-query-interval
```

To restore the IGMP last member query interval to its default value.

You can also restore the IGMP last member query interval on the specified VLAN by entering:

```
-> ip multicast vlan 2 last-member-query-interval 0
```

Or, as an alternative, enter:

```
-> ip multicast vlan 2 last-member-query-interval
```

To restore the IGMP last member query interval to its default value.

Modifying the IGMP Query Response Interval

The default IGMP query response interval (i.e., the time period to reply to an IGMP query message) is 100 in tenths of seconds. The following subsections describe how to configure the query response interval and how to restore it with the **ip multicast query-response-interval** command.

Configuring the IGMP Query Response Interval

You can modify the IGMP query response interval from 1 to 65535 in tenths of seconds by entering **ip multicast query-response-interval** followed by the new value. For example, to set the IGMP query response interval to 6000 tenths-of-seconds you would enter:

```
-> ip multicast query-response-interval 6000
```

You can also modify the IGMP query response interval on the specified VLAN by entering:

```
-> ip multicast vlan 3 query-response-interval 6000
```

Restoring the IGMP Query Response Interval

To restore the IGMP query response interval to its default value on the system if no VLAN is specified, use the **ip multicast query-response-interval** command by entering:

```
-> ip multicast query-response-interval 0
```

Or, as an alternative, enter:

```
-> ip multicast query-response-interval
```

To restore the IGMP query response interval to its default value.

You can also restore the IGMP query response interval on the specified VLAN by entering:

```
-> ip multicast van 2 query-response-interval 0
```

Or, as an alternative, enter:

```
-> ip multicast vlan 2 query-response-interval
```

To restore the IGMP query response interval to its default value.

Modifying the IGMP Router Timeout

The default IGMP router timeout (i.e., expiry time of IP multicast routers) is 90 seconds. The following subsections describe how to configure a user-specified router timeout value and how to restore it with the **ip multicast router-timeout** command.

Configuring the IGMP Router Timeout

You can modify the IGMP router timeout from 1 to 65535 seconds by entering **ip multicast router-timeout** followed by the new value. For example, to set the IGMP router timeout to 360 seconds on the system if no VLAN is specified, you would enter:

```
-> ip multicast router-timeout 360
```

You can also modify the IGMP router timeout on the specified VLAN by entering:

```
-> ip multicast vlan 2 router-timeout 360
```

Restoring the IGMP Router Timeout

To restore the IGMP router timeout to its default value on the system if no VLAN is specified, use the **ip multicast router-timeout** command by entering:

```
-> ip multicast router-timeout 0
```

Or, as an alternative, enter:

```
-> ip multicast router-timeout
```

To restore the IGMP router timeout to its default value.

You can also restore the IGMP router timeout on the specified VLAN by entering:

```
-> ip multicast vlan 2 router-timeout 0
```

Or, as an alternative, enter:

```
-> ip multicast vlan 2 router-timeout
```

To restore the IGMP router timeout to its default value.

Modifying the Source Timeout

The default source timeout (i.e., the expiry time of IP multicast sources) is 30 seconds. The following subsections describe how to configure a user-specified source timeout value and restore it by using the **ip multicast router-timeout** command.

Configuring the Source Timeout

You can modify the source timeout from 1 to 65535 seconds by entering **ip multicast source-timeout** followed by the new value. For example, to set the source timeout to 360 seconds on the system if no VLAN is specified, you would enter:

```
-> ip multicast source-timeout 360
```

You can also modify the source timeout on the specified VLAN by entering:

```
-> ip multicast vlan 2 source-timeout 360
```

Restoring the Source Timeout

To restore the source timeout to its default value on the system if no VLAN is specified, use the **ip multicast source-timeout** command by entering:

```
-> ip multicast source-timeout 0
```

Or, as an alternative, enter:

```
-> ip multicast source-timeout
```

To restore the source timeout to its default value.

You can also restore the source timeout on the specified VLAN by entering:

```
-> ip multicast vlan 2 source-timeout 0
```

Or, as an alternative, enter:

```
-> ip multicast vlan 2 source-timeout
```

To restore the source timeout to its default value.

Enabling and Disabling IGMP Querying

By default, IGMP querying is disabled. The following subsections describe how to enable and disable IGMP querying by using the **ip multicast querying** command.

Enabling the IGMP Querying

You can enable the IGMP querying by entering **ip multicast querying** followed by the **enable** keyword. For example, to enable the IGMP querying on the system if no VLAN is specified, you would enter:

```
-> ip multicast querying enable
```

You can also enable the IGMP querying on the specified VLAN by entering:

```
-> ip multicast vlan 2 querying enable
```

Disabling the IGMP Querying

You can disable the IGMP querying by entering **ip multicast querying** followed by the **disable** keyword. For example, to disable the IGMP querying on the system if no VLAN is specified, you would enter:

```
-> ip multicast querying disable
```

Or, as an alternative, enter:

```
-> ip multicast querying
```

To restore the IGMP querying to its default setting.

You can also disable the IGMP querying on the specified VLAN by entering:

```
-> ip multicast vlan 2 querying disable
```

Or, as an alternative, enter:

```
-> ip multicast vlan 2 querying
```

To restore the IGMP querying to its default setting.

You can remove an IGMP querying entry on the specified VLAN and return to its default behavior by entering:

```
-> no ip multicast vlan 2 querying
```

Modifying the IGMP Robustness Variable

The default value of the IGMP robustness variable (i.e., the variable that allows fine-tuning on a network, where the expected packet loss is higher) is 2. The following subsections describe how to set the value of the robustness variable and restore it with the **ip multicast robustness** command.

Configuring the IGMP Robustness Variable

You can modify the IGMP robustness variable from 1 to 7 on the system if no VLAN is specified, by entering **ip multicast robustness** followed by the new value. For example, to set the value of IGMP robustness to 3 you would enter:

```
-> ip multicast robustness 3
```

Note. If the links are known to be lossy, then robustness variable can be set to a higher value (7).

You can also modify the IGMP robustness variable from 1 to 7 on the specified VLAN by entering:

```
-> ip multicast vlan 2 robustness 3
```

Restoring the IGMP Robustness Variable

You can restore the IGMP robustness variable to its default value on the system if no vlan is specified, by entering **ip multicast robustness** followed by the value 0 as shown below:

```
-> ip multicast robustness 0
```

Or, as an alternative, enter:

```
-> ip multicast robustness
```

To restore the IGMP robustness to its default value.

You can also restore the IGMP robustness variable to its default value on the specified VLAN, by entering **ip multicast robustness** followed by the value 0 as shown below:

```
-> ip multicast vlan 2 robustness 0
```

Or, as an alternative, enter:

```
-> ip multicast vlan 2 robustness
```

To restore the IGMP robustness to its default value.

Enabling and Disabling the IGMP Spoofing

By default, IGMP spoofing (i.e., replacing a client's MAC and IP address with the system's MAC and IP address, when proxying aggregated IGMP group membership information) is disabled on the switch. The following subsections describe how to enable and disable spoofing by using the **ip multicast spoofing** command.

Enabling the IGMP Spoofing

To enable IGMP spoofing on the system if no VLAN is specified, use the **ip multicast spoofing** command as shown below:

```
-> ip multicast spoofing enable
```

You can also enable IGMP spoofing on the specified VLAN by entering:

```
-> ip multicast vlan 2 spoofing enable
```

Disabling the IGMP Spoofing

To disable IGMP spoofing on the system if no VLAN is specified, use the **ip multicast spoofing** command as shown below:

```
-> ip multicast spoofing disable
```

Or, as an alternative, enter:

```
-> ip multicast spoofing
```

To restore the IGMP spoofing to its default setting.

You can also disable IGMP spoofing on the specified VLAN by entering:

```
-> ip multicast vlan 2 spoofing disable
```

Or, as an alternative, enter:

```
-> ip multicast vlan 2 spoofing
```

To restore the IGMP spoofing to its default setting.

You can remove an IGMP spoofing entry on the specified VLAN and return to its default behavior by entering:

```
-> no ip multicast vlan 2 spoofing
```

Enabling and Disabling the IGMP Zapping

By default, IGMP zapping (i.e., processing membership and source filter removals immediately without waiting for the specified time period for the protocol – this mode facilitates IP TV applications looking for quick changes between IP multicast groups) is disabled on a switch. The following subsections describe how to enable and disable IGMP zapping by using the **ip multicast zapping** command.

Enabling the IGMP Zapping

To enable IGMP zapping on the system if no VLAN is specified, use the **ip multicast zapping** command as shown below:

```
-> ip multicast zapping enable
```

You can also enable IGMP zapping on the specified VLAN by entering:

```
-> ip multicast vlan 2 zapping enable
```

Disabling the IGMP Zapping

To disable IGMP zapping on the system if no VLAN is specified, use the **ip multicast zapping** command as shown below:

```
-> ip multicast zapping disable
```

Or, as an alternative, enter:

```
-> ip multicast zapping
```

To restore the IGMP zapping to its default setting.

You can also disable IGMP zapping on the specified VLAN by entering:

```
-> ip multicast vlan 2 zapping disable
```

Or, as an alternative, enter:

```
-> ip multicast vlan 2 zapping
```

To restore the IGMP zapping to its default setting.

Limiting IGMP Multicast Groups

By default there is no limit on the number of IGMP groups that can be learned on a port/vlan instance. A maximum group limit can be set on a port, VLAN or on a global level to limit the number of IGMP groups that can be learned. Once the configured limit is reached, a configurable action decides whether the new IGMP report is dropped or replaces an existing IGMP membership.

The maximum group limit can be applied globally, per VLAN, or per port. Port settings override VLAN settings, which override global settings.

If the maximum number of groups is reached an action can be configured to either drop the new membership request or replace an existing group membership as show below.

Setting the IGMP Group Limit

To set the IGMP global group limit and drop any requests above the limit, use the **ip multicast max-group** command as shown below:

```
-> ip multicast max-group 25 action drop
```

To set the IGMP group limit for a VLAN and replace an existing session use the **ip multicast vlan max-group** command as shown below:

```
-> ip multicast vlan 10 max-group 25 action replace
```

To set the IGMP group limit for a port and drop any requests above the limit, use the **ip multicast port max-group** command as shown below:

```
-> ip multicast port 1/1/1 max-group 25 action drop
```



IPMSv6 Overview

An IPv6 multicast address identifies a group of nodes. A node can belong to any number of multicast groups. IPv6 multicast addresses are classified as fixed scope multicast addresses and variable scope multicast addresses. (See the “[Reserved IPv6 Multicast Addresses](#)” on page 26-24.)

IPMSv6 tracks the source VLAN on which the Multicast Listener Discovery Protocol (MLD) requests are received. The network interfaces verify that a multicast packet is received by the switch on the source (or expected) port.

IPMSv6 Example

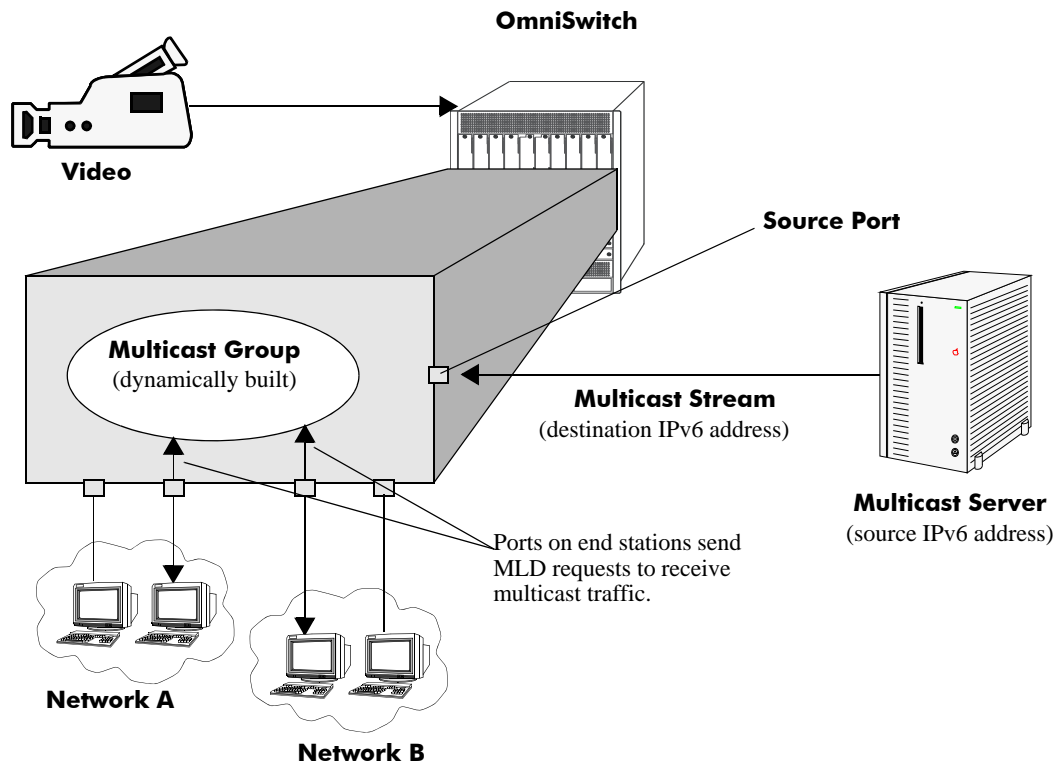
The figure on the following page shows an IPMSv6 network where video content can be provided to clients that request it. A server is attached to the switch that provides the source (i.e., multicast) IPv6 addresses. Clients from two different attached networks send MLD reports to the switch to receive the video content.



Reserved IPv6 Multicast Addresses

The Internet Assigned Numbers Authority (IANA) classified the scope for IPv6 multicast addresses as fixed scope multicast addresses and variable scope multicast addresses. However, as the table below shows only well-known addresses, which are reserved and cannot be assigned to any multicast group.

Address	Description
FF00:0:0:0:0:0:0:0	reserved
FF01:0:0:0:0:0:0:0	node-local scope address
FF02:0:0:0:0:0:0:0	link-local scope
FF03:0:0:0:0:0:0:0	unassigned
FF04:0:0:0:0:0:0:0	unassigned
FF05:0:0:0:0:0:0:0	site-local scope
FF06:0:0:0:0:0:0:0	unassigned
FF07:0:0:0:0:0:0:0	unassigned
FF08:0:0:0:0:0:0:0	organization-local scope
FF09:0:0:0:0:0:0:0	unassigned
FF0A:0:0:0:0:0:0:0	unassigned
FF0B:0:0:0:0:0:0:0	unassigned
FF0C:0:0:0:0:0:0:0	unassigned
FF0D:0:0:0:0:0:0:0	unassigned
FF0E:0:0:0:0:0:0:0	global scope
FF0F:0:0:0:0:0:0:0	reserved

MLD Version 2

MLD is used by IPv6 systems (hosts and routers) to report their IPv6 multicast group memberships to any neighboring multicast routers. MLD Version 1 (MLDv1) handles forwarding by IPv6 multicast destination addresses only. MLD Version 2 (MLDv2) handles forwarding by source IPv6 addresses and IPv6 multicast destination addresses. Both MLDv1 and MLDv2 are supported.

Note. See [“Configuring the MLD Version 2”](#) on page 26-26 for information on configuring the IGMP version.

MLDv2 uses source filtering and reports multicast memberships to neighboring routers by sending membership reports. MLDv2 also supports Source Specific Multicast (SSM) by allowing hosts to report interest in receiving packets only from specific source addresses or from all but specific source addresses.

Configuring IPMSv6 on a Switch

This section describes how to use Command Line Interface (CLI) commands to enable and disable IPv6 Multicast Switching (IPMSv6) switch wide (see “[Enabling and Disabling IPv6 Multicast Status](#)” on page 26-25), configure a port as an MLD static neighbor (see “[Configuring and Removing an MLD Static Neighbor](#)” on page 26-27), configure a port as an MLD static querier (see “[Configuring and Removing an MLD Static Querier](#)” on page 26-27), and configure a port as an MLD static group (see “[Configuring and Removing an MLD Static Group](#)” on page 26-28)

Note. See the “IP Multicast Switching Commands” chapter in the *OmniSwitch AOS Release 8 CLI Reference Guide* for complete documentation of IPMSv6 CLI commands.

Enabling and Disabling IPv6 Multicast Status

IPv6 Multicast is disabled by default on a switch. The following subsections describe how to enable and disable IPv6 Multicast by using the **ip multicast helper-address** command.

Note. If IPv6 Multicast switching and routing is enabled on the system, the VLAN configuration overrides the configuration of the system.

Enabling IPv6 Multicast Status

To enable IPv6 Multicast switching and routing on the system if no VLAN is specified, use the **ip multicast helper-address** command as shown below:

```
-> ipv6 multicast admin-state enable
```

You can also enable IPv6 Multicast switching and routing on the specified VLAN by entering:

```
-> ipv6 multicast vlan 2 admin-state enable
```

Disabling IPv6 Multicast Status

To disable IPv6 Multicast switching and routing on the system if no VLAN is specified, use the **ip multicast helper-address** command as shown below:

```
-> ipv6 multicast admin-state disable
```

Or, as an alternative, enter:

```
-> ipv6 multicast admin-state
```

To restore the IPv6 Multicast status to its default setting.

You can also disable IPv6 Multicast on the specified VLAN by entering:

```
-> ipv6 multicast vlan 2 admin-state disable
```

Or, as an alternative, enter:

```
-> ipv6 multicast vlan 2 admin-state
```

To restore the IPv6 Multicast status to its default setting.

Enabling and Disabling MLD Querier-forwarding

By default, MLD querier-forwarding is disabled. The following subsections describe how to enable and disable MLD querier-forwarding by using the **ipv6 multicast querier-forwarding** command.

Enabling the MLD Querier-forwarding

You can enable the MLD querier-forwarding by entering **ipv6 multicast querier-forwarding** followed by the **enable** keyword. For example, to enable the MLD querier-forwarding on the system if no VLAN is specified, you would enter:

```
-> ipv6 multicast querier-forwarding enable
```

You can also enable the MLD querier-forwarding on the specified VLAN by entering:

```
-> ipv6 multicast vlan 2 querier-forwarding enable
```

Disabling the MLD Querier-forwarding

You can disable the MLD querier-forwarding by entering **ipv6 multicast querier-forwarding** followed by the **disable** keyword. For example, to disable the MLD querier-forwarding on the system if no VLAN is specified, you would enter:

```
-> ipv6 multicast querier-forwarding disable
```

Or, as an alternative, enter:

```
-> ipv6 multicast querier-forwarding
```

To restore the MLD querier-forwarding to its default setting.

You can also disable the MLD querier-forwarding on the specified VLAN by entering:

```
-> ipv6 multicast vlan 2 querier-forwarding disable
```

Or, as an alternative, enter:

```
-> ipv6 multicast vlan 2 querier-forwarding
```

To restore the MLD querier-forwarding to its default setting.

You can remove an MLD querier-forwarding entry on the specified VLAN and return to its default behavior by entering:

```
-> no ipv6 multicast vlan 2 querier-forwarding
```

Configuring and Restoring the MLD Version

By default, the version of Multicast Listener Discovery (MLD) Protocol is Version 1. The following subsections describe how to configure the MLD version as Version 1 or Version 2 by using the **ipv6 multicast flood-unknown** command.

Configuring the MLD Version 2

To change the MLD version to Version 2 (MLDv2) on the system if no VLAN is specified, use the **ipv6 multicast flood-unknown** command as shown below:

```
-> ipv6 multicast version 2
```

Restoring the MLD Version 1

To restore the MLD version to Version 1 (MLDv1) on the system if no VLAN is specified, use the **ipv6 multicast flood-unknown** command by entering:

```
-> ipv6 multicast version 0
```

Or, as an alternative, enter:

```
-> ipv6 multicast version
```

To restore the MLD version to Version 1.

You can also restore the MLD version to Version 1 (MLDv1) on the specified VLAN by entering:

```
-> ipv6 multicast vlan 2 version 0
```

Or, as an alternative, enter:

```
-> ipv6 multicast vlan 2 version
```

To restore the MLD version to Version 1.

Configuring and Removing an MLD Static Neighbor

MLD static neighbor ports receive all multicast streams on the designated VLAN and also receive MLD reports for the VLAN. The following subsections describe how to configure and remove a static neighbor port by using the **ipv6 multicast static-neighbor** command.

Configuring an MLD Static Neighbor

You can configure a port as an MLD static neighbor port by entering **ipv6 multicast static-neighbor**, followed by the VLAN and port. For example:

```
-> ipv6 multicast static-neighbor vlan 2 port 1/1/10
```

You can also configure a link aggregation group as an MLD static neighbor port by entering **ipv6 multicast static-neighbor**, followed by the VLAN and link aggregate. For example:

```
-> ipv6 multicast static-neighbor vlan 2 linkagg 7
```

Removing an MLD Static Neighbor

To reset the port so that it is no longer an MLD static neighbor port, use the **no** form of the **ipv6 multicast max-group** command. For example:

```
-> no ipv6 multicast static-neighbor vlan 2 port 1/1/10
```

Configuring and Removing an MLD Static Querier

MLD static querier ports receive MLD reports generated on the designated VLAN. Unlike MLD neighbor ports, they do not receive all multicast streams. The following subsections describe how to configure and remove a static querier by using the **ipv6 multicast static-querier** command.

Configuring an MLD Static Querier

You can configure a port as an MLD static querier port by entering **ipv6 multicast static-querier**, followed by the VLAN and port. For example:

```
-> ipv6 multicast static-querier vlan 2 port 1/1/10
```

You can also configure a link aggregation group as an MLD static querier port by entering **ipv6 multicast static-querier**, followed by the VLAN and link aggregate. For example:

```
-> ipv6 multicast static-querier vlan 2 linkagg 7
```

Removing an MLD Static Querier

To reset the port, so that it is no longer an MLD static querier port, use the **no** form of the **ipv6 multicast static-querier** command. For example:

```
-> no ipv6 multicast static-querier vlan 2 port 1/1/10
```

Configuring and Removing an MLD Static Group

MLD static group ports receive MLD reports generated on the specified IPv6 Multicast group address. The following subsections describe how to configure and remove an MLD static group by using the **ipv6 multicast static-group** command.

Configuring an MLD Static Group

You can configure a port as an MLD static group by entering **ipv6 multicast static-group**, followed by the IPv6 address, VLAN and port. For example:

```
-> ipv6 multicast static-group ff05::5 vlan 3 port 1/1/10
```

You can also configure a link aggregation group as an MLD static group by entering **ipv6 multicast static-group**, followed by the IPv6 address, VLAN, and link aggregate. For example:

```
-> ipv6 multicast static-group ff05::6 vlan 2 linkagg 7
```

Removing an MLD Static Group

To reset the port so that it is no longer an MLD static group port, use the **no** form of the **ipv6 multicast static-group** command. For example:

```
-> no ipv6 multicast static-group ff05::5 vlan 3 port 1/1/10
```

Modifying IPMSv6 Parameters

The table in “[IPMSv6 Default Values](#)” on page 26-5 lists default values for IPMSv6 parameters. The following sections describe how to use CLI commands to modify these parameters.

Modifying the MLD Query Interval

The default IPMSv6 query interval (i.e., the time between MLD queries) is 125 in seconds. The following subsections describe how to configure a user-specified query interval value and restore it by using the **ipv6 multicast query-interval** command.

Configuring the MLD Query Interval

You can modify the MLD query interval from 1 to 65535 in seconds by entering **ipv6 multicast query-interval** followed by the new value. For example, to set the MLD query interval to 60 seconds on the system if no VLAN is specified, you would enter:

```
-> ipv6 multicast query-interval 160
```

You can also modify the MLD query interval on the specified VLAN by entering:

```
-> ipv6 multicast vlan 2 query-interval 160
```

Restoring the MLD Query Interval

To restore the MLD query interval to its default value on the system if no VLAN is specified, use the **ipv6 multicast query-interval** command by entering:

```
-> no ipv6 multicast query-interval
```

You can also restore the MLD query interval on the specified VLAN by entering:

```
-> no ipv6 multicast vlan 2 query-interval
```

Modifying the MLD Last Member Query Interval

The default MLD last member query interval (i.e., the time period to reply to an MLD query message sent in response to a leave group message) is 1000 in milliseconds. The following subsections describe how to configure the MLD last member query interval and restore it by using the **ipv6 multicast last-member-query-interval** command.

Configuring the MLD Last Member Query Interval

You can modify the MLD last member query interval from 1 to 65535 in milliseconds by entering **ipv6 multicast last-member-query-interval** followed by the new value. For example, to set the MLD last member query interval to 600 milliseconds on the system if no VLAN is specified, you would enter:

```
-> ipv6 multicast last-member-query-interval 2200
```

You can also modify the MLD last member query interval on the specified VLAN by entering:

```
-> ipv6 multicast vlan 3 last-member-query-interval 2200
```

Restoring the MLD Last Member Query Interval

To restore the MLD last member query interval to its default value on the system if no VLAN is specified, use the **ipv6 multicast last-member-query-interval** command by entering:

```
-> ipv6 multicast last-member-query-interval 0
```

Or, as an alternative, enter:

```
-> ipv6 multicast last-member-query-interval
```

To restore the MLD last member query interval to its default value.

You can also restore the MLD last member query interval on the specified VLAN by entering:

```
-> ipv6 multicast vlan 2 last-member-query-interval 0
```

Or, as an alternative, enter:

```
-> ipv6 multicast vlan 2 last-member-query-interval
```

To restore the MLD last member query interval to its default value.

Modifying the MLD Query Response Interval

The default MLD query response interval (i.e., the time period to reply to an MLD query message) is 10000 in milliseconds. The following subsections describe how to configure the MLD query response interval and restore it by using the **ipv6 multicast query-response-interval** command.

Configuring the MLD Query Response Interval

You can modify the MLD query response interval from 1 to 65535 in milliseconds by entering **ipv6 multicast last-member-query-interval** followed by the new value. For example, to set the MLD query response interval to 6000 milliseconds you would enter:

```
-> ipv6 multicast query-response-interval 20000
```

You can also modify the MLD query response interval on the specified VLAN by entering:

```
-> ipv6 multicast vlan 3 query-response-interval 20000
```

Restoring the MLD Query Response Interval

To restore the MLD query response interval to its default value on the system if no VLAN is specified, use the **ipv6 multicast query-response-interval** command by entering:

```
-> ipv6 multicast query-response-interval 0
```

Or, as an alternative, enter:

```
-> ipv6 multicast query-response-interval
```

To restore the MLD query response interval to its default value.

You can also restore the MLD query response interval on the specified VLAN by entering:

```
-> ipv6 multicast van 2 query-response-interval 0
```

Or, as an alternative, enter:

```
-> ipv6 multicast vlan 2 query-response-interval
```

To restore the MLD query response interval to its default value.

Modifying the MLD Router Timeout

The default MLD router timeout (i.e., expiry time of IPv6 multicast routers) is 90 seconds. The following subsections describe how to configure a user-specified router timeout value and restore it by using the [ipv6 multicast router-timeout](#) command.

Configuring the MLD Router Timeout

You can modify the MLD router timeout from 1 to 65535 seconds by entering [ipv6 multicast router-timeout](#) followed by the new value. For example, to set the MLD router timeout to 360 seconds on the system if no VLAN is specified, you would enter:

```
-> ipv6 multicast router-timeout 360
```

You can also modify the MLD router timeout on the specified VLAN by entering:

```
-> ipv6 multicast vlan 2 router-timeout 360
```

Restoring the MLD Router Timeout

To restore the MLD router timeout to its default value on the system if no VLAN is specified, use the [ipv6 multicast router-timeout](#) command by entering:

```
-> ipv6 multicast router-timeout 0
```

Or, as an alternative, enter:

```
-> ipv6 multicast router-timeout
```

To restore the MLD router timeout to its default value.

You can also restore the MLD router timeout on the specified VLAN by entering:

```
-> ipv6 multicast vlan 2 router-timeout 0
```

Or, as an alternative, enter:

```
-> ipv6 multicast vlan 2 router-timeout
```

To restore the MLD router timeout to its default value.

Modifying the Source Timeout

The default source timeout (i.e., expiry time of IPv6 multicast sources) is 30 seconds. The following subsections describe how to configure a user-specified source timeout value and restore it by using the [ipv6 multicast source-timeout](#) command.

Configuring the Source Timeout

You can modify the source timeout from 1 to 65535 seconds by entering **ipv6 multicast source-timeout** followed by the new value. For example, to set the source timeout to 360 seconds on the system if no VLAN is specified, you would enter:

```
-> ipv6 multicast source-timeout 60
```

You can also modify the source timeout on the specified VLAN by entering:

```
-> ipv6 multicast vlan 2 source-timeout 60
```

Restoring the Source Timeout

To restore the source timeout to its default value on the system if no VLAN is specified, use the **ipv6 multicast source-timeout** command by entering:

```
-> ipv6 multicast source-timeout 0
```

Or, as an alternative, enter:

```
-> ipv6 multicast source-timeout
```

To restore the source timeout to its default value.

You can also restore the source timeout on the specified VLAN by entering:

```
-> ipv6 multicast vlan 2 source-timeout 0
```

Or, as an alternative, enter:

```
-> ipv6 multicast vlan 2 source-timeout
```

To restore the source timeout to its default value.

Enabling and Disabling the MLD Querying

By default MLD querying is disabled. The following subsections describe how to enable and disable MLD querying by using the **ipv6 multicast querying** command.

Enabling the MLD Querying

You can enable the MLD querying by entering **ipv6 multicast querying** followed by the **enable** keyword. For example, to enable the MLD querying you would enter:

```
-> ipv6 multicast querying enable
```

You can also enable the MLD querying on the specified VLAN by entering:

```
-> ipv6 multicast vlan 2 querying enable
```

Disabling the MLD Querying

You can disable the MLD querying by entering **ipv6 multicast querying** followed by the **disable** keyword. For example, to disable the MLD querying you would enter:

```
-> ipv6 multicast querying disable
```

Or, as an alternative, enter:

```
-> ipv6 multicast querying
```

To restore the MLD querying to its default setting.

You can also disable the MLD querying on the specified VLAN by entering:

```
-> ipv6 multicast vlan 2 querying disable
```

Or, as an alternative, enter:

```
-> ipv6 multicast vlan 2 querying
```

To restore the MLD querying to its default setting.

You can remove an MLD querying entry on the specified VLAN and return to its default behavior by entering:

```
-> no ipv6 multicast vlan 2 querying
```

Modifying the MLD Robustness Variable

The default value of the robustness variable (i.e., the variable that allows fine-tuning on the network, where the expected packet loss is greater) is 2. The following subsections describe how to set the value of the MLD robustness variable and restore it by using the **ipv6 multicast robustness** command.

Configuring the MLD Robustness Variable

You can modify the MLD robustness variable from 1 to 7 on the system if no vlan is specified, by entering **ipv6 multicast robustness**, followed by the new value. For example, to set the value of robustness to 3 you would enter:

```
-> ipv6 multicast robustness 3
```

Note. If the links are known to be lossy, then robustness can be set to a higher value (7).

You can also modify the MLD robustness variable from 1 to 7 on the specified VLAN by entering:

```
-> ipv6 multicast vlan 2 robustness 3
```

Restoring the MLD Robustness Variable

You can restore the MLD robustness variable to its default value on the system if no vlan is specified by entering **ipv6 multicast robustness** followed by the value 0, as shown below:

```
-> ipv6 multicast robustness 0
```

Or, as an alternative, enter:

```
-> ipv6 multicast robustness
```

To restore the MLD robustness to its default value.

You can also modify the MLD robustness variable from 1 to 7 on the specified VLAN by entering:

```
-> ipv6 multicast vlan 2 robustness 0
```

Or, as an alternative, enter:

```
-> ipv6 multicast vlan 2 robustness
```

To restore the MLD robustness to its default value.

Enabling and Disabling the MLD Spoofing

By default, MLD spoofing (i.e., replacing a client's MAC and IPv6 address with the system's MAC and IPv6 address, when proxying aggregated MLD group membership information) is disabled on the switch. The following subsections describe how to enable and disable spoofing by using the **ipv6 multicast spoofing** command.

Enabling the MLD Spoofing

To enable MLD spoofing on the system if no VLAN is specified, you use the **ipv6 multicast spoofing** command as shown below:

```
-> ipv6 multicast spoofing enable
```

You can also enable MLD spoofing on the specified VLAN by entering:

```
-> ipv6 multicast vlan 2 spoofing enable
```

Disabling the MLD Spoofing

To disable MLD spoofing on the system if no VLAN is specified, you use the **ipv6 multicast spoofing** command as shown below:

```
-> ipv6 multicast spoofing disable
```

Or, as an alternative, enter:

```
-> ipv6 multicast spoofing
```

To restore the MLD spoofing to its default setting.

You can also disable MLD spoofing on the specified VLAN by entering:

```
-> ipv6 multicast vlan 2 spoofing disable
```

Or, as an alternative, enter:

```
-> ipv6 multicast vlan 2 spoofing
```

To restore the MLD spoofing to its default setting.

You can remove an MLD spoofing entry on the specified VLAN and return to its default behavior by entering:

```
-> no ipv6 multicast vlan 2 spoofing
```

Enabling and Disabling the MLD Zapping

By default MLD (i.e., processing membership and source filter removals immediately without waiting for the specified time period for the protocol– this mode facilitates IP TV applications looking for quick changes between IP multicast groups.) is disabled on a switch. The following subsections describe how to enable and disable zapping by using the **ipv6 multicast zapping** command.

Enabling the MLD Zapping

To enable MLD zapping on the system if no VLAN is specified, use the **ipv6 multicast zapping** command as shown below:

```
-> ipv6 multicast zapping enable
```

You can also enable MLD zapping on the specified VLAN by entering:

```
-> ipv6 multicast vlan 2 zapping enable
```

Disabling the MLD Zapping

To disable MLD zapping on the system if no VLAN is specified, use the **ipv6 multicast zapping** command as shown below:

```
-> ipv6 multicast zapping disable
```

Or, as an alternative, enter:

```
-> ipv6 multicast zapping
```

To restore the MLD zapping to its default setting.

You can also disable MLD zapping on the specified VLAN by entering:

```
-> ipv6 multicast vlan 2 zapping disable
```

Or, as an alternative, enter:

```
-> ipv6 multicast vlan 2 zapping
```

To restore the MLD zapping to its default setting.

Limiting MLD Multicast Groups

By default there is no limit on the number of MLD groups that can be learned on a port/vlan instance. A maximum group limit can be set on a port, VLAN or on a global level to limit the number of MLD groups that can be learned. Once the configured limit is reached, a configurable action decides whether the new MLD report is dropped or replaced an existing MLD membership.

The maximum group limit can be applied globally, per VLAN, or per port. Port settings override VLAN settings, which override global settings.

If the maximum number of groups is reached an action can be configured to either drop the new membership request or replace an existing group membership as show below.

Setting the MLD Group Limit

To set the MLD global group limit and drop any requests above the limit, use the **ip multicast max-group** command as shown below:

```
-> ipv6 multicast max-group 25 action drop
```

To set the MLD group limit for a VLAN and replace any requests above the limit, use the **ip multicast vlan max-group** command as shown below:

```
-> ipv6 multicast vlan 10 max-group 25 action replace
```

To set the MLD group limit for a port and drop any requests above the limit, use the **ip multicast port max-group** command as shown below:

```
-> ipv6 multicast port 1/1/1 max-group 25 action drop
```

IPMS Application Example

The figure below shows a sample network with the switch sending multicast video. A client attached to Port 5 needs to be configured as a static IGMP neighbor and another client attached to Port 2 needs to be configured as a static IGMP querier.

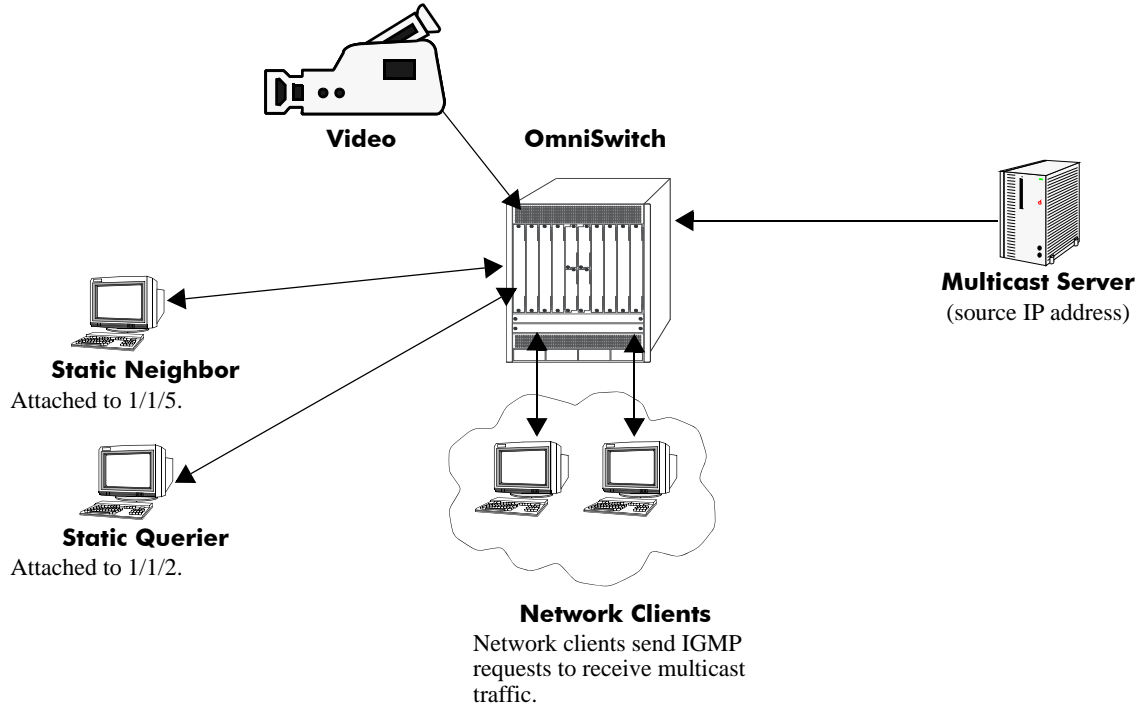

Example of IMPS Network

The network administrator has determined that the network is too lossy and therefore the robustness variable needs to be set to a higher (i.e., 7) value.

Follow the steps below to configure this network:

Note. All the steps following Step 1 (which must be executed first) can be entered in any order.

- 1** Enable IP Multicast Switching and Routing switch-wide, by entering:

```
-> ip multicast admin-state enable
```
- 2** Configure the client attached to Port 5 as a static neighbor belonging to VLAN 5 by entering:

```
-> ip multicast static-neighbor vlan 5 port 1/1/5
```
- 3** Configure the client attached to Port 2 as a static querier belonging to VLAN 5 by entering:

```
-> ip multicast static-querier vlan 5 port 1/1/2
```
- 4** Modify the robustness variable from its default value of 2 to 7 by entering:

```
-> ip multicast robustness 7
```

An example of what these commands look like entered sequentially on the command line:

```
-> ip multicast admin-state enable
-> ip multicast static-neighbor vlan 5 port 1/1/5
-> ip multicast static-querier vlan 5 port 1/1/2
-> ip multicast robustness 7
```

As an option, you can use the **ipv6 multicast initial-packet-buffer min-delay**, **show ip multicast neighbor**, and **show ip multicast querier** commands to confirm your settings as shown below:

```
-> show ip multicast
```

```
Status: = Enabled
Querying: = Disabled
Proxying: = Disabled
Spoofing: = Disabled
Zapping: = Disabled
Querier Forwarding: = Disabled
Version: = 1
Robustness: = 2
Query Interval (seconds): = 125
Query Response Interval (milliseconds): = 10000
Last Member Query Interval(milliseconds): = 1000
Unsolicited Report Interval (seconds) = 1,
Router Timeout (seconds): = 90
Source Timeout (seconds): = 30
```

```
-> show ip multicast neighbor
```

```
Total 1 Neighbors
Host Address      VLAN  Port  Static  Count  Life
-----+-----+-----+-----+-----
1.0.0.2           5    1/1/5  no      1      86
```

```
-> show ip multicast querier
```

```
Total 1 Queriers
Host Address      VLAN  Port  Static  Count  Life
-----+-----+-----+-----+-----
1.0.0.3           5    1/1/2  no      1     250
```

IPMSv6 Application Example

The figure below shows a sample network with the switch sending multicast video. A client attached to Port 5 needs to be configured as a static MLD neighbor and another client attached to Port 2 needs to be configured as a static MLD querier.

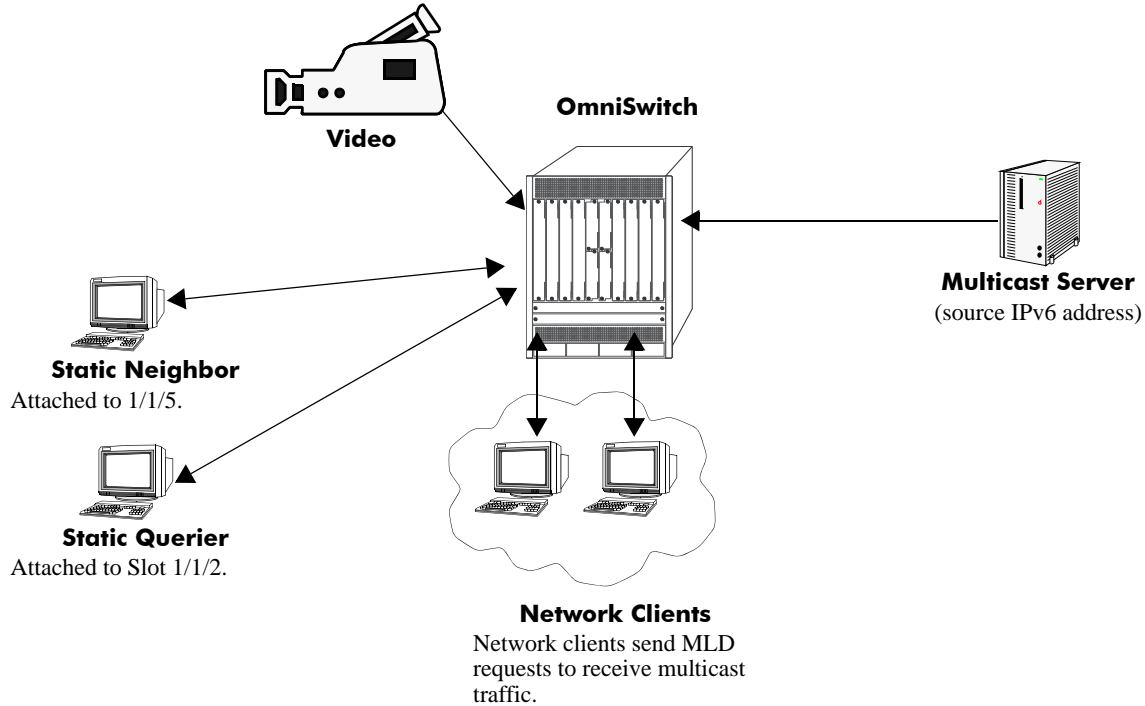

Example of IMPS Network

The network administrator has determined that the network is too lossy and therefore the robustness variable needs to be set to a higher (i.e., 7) value.

Follow the steps below to configure this network:

Note. All the steps following Step 1 (which must be executed first) can be entered in any order.

- 1** Enable IP Multicast Switching and Routing switch-wide, by entering:

```
-> ipv6 multicast admin-state enable
```
- 2** Configure the client attached to Port 5 as a static MLD neighbor belonging to VLAN 5 by entering:

```
-> ipv6 multicast static-neighbor vlan 5 port 1/1/5
```
- 3** Configure the client attached to Port 2 as a static MLD querier belonging to VLAN 5 by entering:

```
-> ipv6 multicast static-querier vlan 5 port 1/1/2
```
- 4** Modify the robustness variable from its default value of 2 to 7 by entering:

```
-> ipv6 multicast robustness 7
```

An example of what these commands look like entered sequentially on the command line:

```
-> ipv6 multicast admin-state enable
-> ipv6 multicast static-neighbor vlan 5 port 1/1/5
-> ipv6 multicast static-querier vlan 5 port 1/1/2
-> ipv6 multicast robustness 7
```

As an option, you can use the **show ipv6 multicast**, **show ipv6 multicast neighbor**, and **show ipv6 multicast querier** commands to confirm your settings as shown below:

```
-> show ipv6 multicast
```

```
Status: = Enabled
Querying: = Disabled
Proxying: = Disabled
Spoofing: = Disabled
Zapping: = Disabled
Querier Forwarding: = Disabled
Version: = 1
Robustness: = 2
Query Interval (seconds): = 125
Query Response Interval (milliseconds): = 10000
Last Member Query Interval(milliseconds): = 1000
Unsolicited Report Interval (seconds) = 1,
Router Timeout (seconds): = 90
Source Timeout (seconds): = 30
```

```
-> show ipv6 multicast neighbor
```

```
Total 1 Neighbors
Host Address          VLAN  Port  Static  Count  Life
-----+-----+-----+-----+-----
fe80::2a0:ccff:fed3:2853  5    1/1/5  no      1      6
```

```
-> show ipv6 multicast querier
```

```
Total 1 Queriers
Host Address          VLAN  Port  Static  Count  Life
-----+-----+-----+-----+-----
fe80::2a0:ccff:fed3:2854  5    1/1/2  no      1      6
```

Displaying IPMS Configurations and Statistics

Alcatel-Lucent's IP Multicast Switching (IPMS) **show** commands provide tools to monitor IPMS traffic and settings and to troubleshoot problems. These commands are described below:

ipv6 multicast initial-packet-buffer min-delay	Displays the general IP Multicast switching and routing configuration parameters on a switch.
show ip multicast group	Displays all detected multicast groups that have members. If you do not specify an IP address then all multicast groups on the switch is displayed.
show ip multicast neighbor	Displays all neighboring multicast routers.
show ip multicast querier	Displays all multicast queriers.
show ip multicast port	Displays the IPMS multicast forwarding table. If you do not specify a multicast group IP address, then the forwarding table for all multicast groups are displayed.
show ip multicast source	Displays the IPMS multicast source table. If you do not specify a multicast group IP address, then the source table for all multicast groups are displayed.
show ip multicast tunnel	Displays the IP multicast switch and routing tunneling table entries matching the specified IP multicast group address, or all the entries if no IP multicast address is specified.

If you are interested in a quick look at IPMS groups on your switch you could use the **show ip multicast group** command. For example:

```
-> show ip multicast group
```

```
Total 3 Groups
Group Address      Source Address  VLAN  Port  Mode      Static  Count  Life
-----+-----+-----+-----+-----+-----+-----+-----
231.0.0.3         1.0.0.5        1     1/1/1  exclude  no      1      257
234.0.0.4         0.0.0.0        1     1/1/1  exclude  no      1      218
229.0.0.1         0.0.0.0        1     1/1/13 exclude  yes     0       0
```

Note. See the “IP Multicast Switching Commands” chapter in the *OmniSwitch AOS Release 8 CLI Reference Guide* for complete documentation on IPMS **show** commands.

Displaying IPMSv6 Configurations and Statistics

Alcatel-Lucent's IPv6 Multicast Switching (IPMSv6) **show** commands provide tools to monitor IPMSv6 traffic and settings and to troubleshoot problems. These commands are described below:

show ipv6 multicast	Displays the general IPv6 Multicast switching and routing configuration parameters on a switch.
show ipv6 multicast group	Displays all detected multicast groups that have members. If you do not specify an IPv6 address, then all multicast groups on the switch are displayed.
show ipv6 multicast neighbor	Displays all neighboring IPv6 multicast routers.
show ipv6 multicast querier	Displays all IPv6 multicast queriers.
show ipv6 multicast port	Displays the IPMSv6 multicast forwarding table. If you do not specify a multicast group IPv6 address, then the forwarding table for all multicast groups are displayed.
show ipv6 multicast source	Displays the IPMSv6 multicast source table. If you do not specify a multicast group IPv6 address, then the source table for all multicast groups are displayed.
show ipv6 multicast tunnel	Display the IPv6 multicast switch and routing tunneling table entries matching the specified IPv6 multicast group address, or all the entries if no IPv6 multicast address is specified.

If you are interested in a quick look at IPMSv6 groups on your switch you could use the **show ipv6 multicast group** command. For example:

```
-> show ipv6 multicast group
```

```
Total 3 Groups
Group Address      Source Address  VLAN  Port  Mode      Static  Count  Life
-----+-----+-----+-----+-----+-----+-----+-----
ff05::5           ::              1     1/1/1  exclude  no      1     145
ff05::6           3333::1        1     1/1/1  exclude  no      1     242
ff05::9           ::              1     1/1/13 exclude  yes     0     0
```

Note. See the “IPv6 Multicast Switching Commands” chapter in the *OmniSwitch AOS Release 8 CLI Reference Guide* for complete documentation on IPMS **show** commands.

27 Configuring QoS

The OmniSwitch software and queue management architecture provide a way to identify traffic entering the network and manipulate flows coming through the switch. The flow manipulation (generally referred to as *Quality of Service* or *QoS*) can be as simple as configuring QoS policies to allow/deny traffic or as complicated as remapping 802.1p bits from a Layer 2 network to ToS values in a Layer 3 network.

The types of policies typically used include, but are not limited to, the following:

- **Basic QoS**—includes traffic prioritization and bandwidth shaping.
- **ICMP policies**—includes filtering, prioritizing, and/or rate limiting ICMP traffic for security.
- **802.1p/ToS/DSCP**—includes policies for marking and mapping.
- **Policy Based Routing (PBR)**—includes policies for redirecting routed traffic.
- **Policy Based Mirroring**—includes mirror-to-port (MTP) policies for mirroring ingress, egress, or both ingress and egress traffic.
- **Access Control Lists (ACLs)**—ACLs are a specific type of QoS policy that is used for Layer 2 and Layer 3/4 filtering. See [“Using Access Control Lists” on page 27-55](#).

This implementation of QoS integrates traffic management with QoS scheduling. Embedded profiles apply the QoS admission control and bandwidth management configurations to traffic flows.

In This Chapter

This chapter describes QoS in general and how policies, port-based QoS configuration, and queue management are used on the switch. It provides information about configuring QoS through the Command Line Interface (CLI). CLI commands are used in the configuration examples; for more details about the syntax of commands, see the *OmniSwitch AOS Release 8 CLI Reference Guide*.

The following topics and procedures are included in this chapter:

- [“QoS General Overview” on page 27-3](#).
- [“Classification” on page 27-4](#).
- [“Congestion Management” on page 27-9](#).
- [“Traffic Policing and Shaping” on page 27-13](#).
- [“QoS Defaults” on page 27-26](#).
- [“Configuring QoS” on page 27-30](#).
- [“Policy Applications” on page 27-66](#).

QoS Specifications

The QoS functionality described in this chapter is supported on the OmniSwitch 6860 switches, unless otherwise stated in the following QoS Specifications table or specifically noted within any other section of this chapter. Note that any maximum limits provided in the QoS Specifications table are subject to available system resources.

Maximum number of policy rules	3072
Maximum number of bandwidth rules	1536
Maximum number of validity periods	64
Maximum number of policy services	256
Maximum number of groups (network, MAC, service, port)	1024
Maximum number of group entries	1024 per group
Maximum number of Class of Service (CoS) queues per port.	8
Queue Set Profiles (QSP)	4
Weighted Random Early Detection profiles (WRP)	Not Supported
Maximum number of QoS policy lists per switch	32 (excludes the default list)
Maximum number of QoS policy lists per Universal Network Profile (UNP)	1
Port Default Trusted Mode	Untrusted

QoS General Overview

Quality of Service (QoS) refers to transmission quality and available service that is measured and sometimes guaranteed in advance for a particular type of traffic in a network. QoS lends itself to circuit-switched networks like ATM, which bundle traffic into cells of the same length and transmit the traffic over predefined virtual paths. In contrast, IP and other packet-switched networks operate on the concept of shared resources and *best effort* routing, using bandwidth as needed and reassembling packets at their destinations. Applying QoS to packet-switched networks requires different mechanisms than those used in circuit-switched networks.

QoS is often defined as a way to manage bandwidth. Another way to handle different types of flows and increased bandwidth requirements is to add more bandwidth. But bandwidth can be expensive, particularly at the WAN connection. If LAN links that connect to the WAN are not given more bandwidth, bottlenecks can still occur. Also, adding enough bandwidth to compensate for peak load periods mean that at times some bandwidth is unused. In addition, adding bandwidth does not guarantee any kind of control over network resources.

Using QoS, a network administrator can gain more control over networks where different types of traffic (or flows) are in use or where network congestion is high. Preferential treatment can be given to individual flows as required. Voice over IP (VoIP) traffic or mission-critical data can be marked as priority traffic and/or given more bandwidth on the link. QoS can also prevent large flows, such as a video stream, from consuming all the bandwidth on a link. Using QoS, a network administrator can decide which traffic needs preferential treatment and which traffic can be adequately served with best effort.

QoS is implemented on the switch through the use of user-defined policies, port-based QoS configuration, and integration with virtual output queuing to manage egress congestion. The following simplified illustration shows an example of how video traffic can receive priority over email traffic.

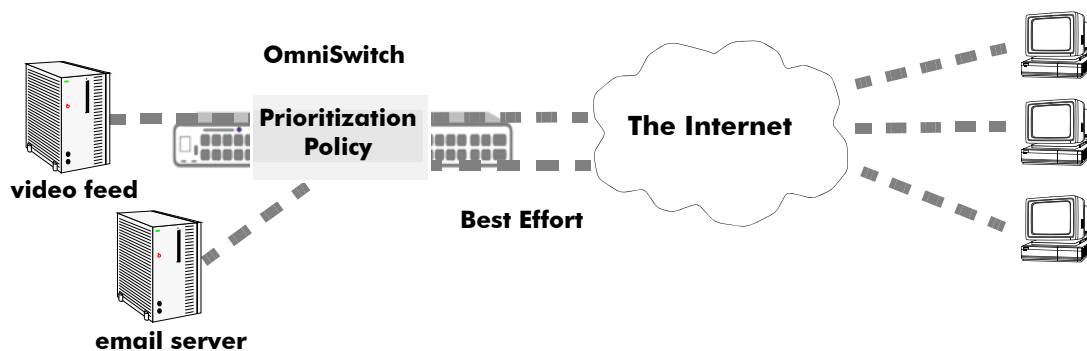

Sample QoS Setup

QoS sits in the ingress and egress software path. IP calls QoS to validate packets destined for the switch. IP also calls QoS to validate and/or prioritize packets originating from the switch.

The general order of events with respect to the OmniSwitch implementation of QoS are as follows:

- 1 Classification**—Packets are classified and marked according to policies and traffic behavior. This is accomplished on the ingress using technologies, such as 802.1p, IP precedence and Diffserv Code Point (DSCP). See [“Classification” on page 27-4](#) for more information.
- 2 Congestion Management**—Classified packets are prioritized and placed into queues based on Class of Service (CoS) markings to ensure preferential treatment to high priority traffic. See [“Congestion Management” on page 27-9](#).

3 Traffic Policing and Shaping—Packet flows are policed or shaped to limit the rate of traffic received or sent by the switch. See [“Traffic Policing and Shaping” on page 27-13](#).

Classification

Classification is the process of identifying certain types of network traffic (flows) and then, if necessary, marking a specific flow or group of flows with a priority (class of service) value. The class of service (CoS) value assigned is then used by other QoS features to determine how the flow is treated throughout the network.

The CoS value assigned to a specific flow is based on one of the following technologies:

- **IP Precedence**—Type of Service (ToS) or Differentiated Services (DiffServ).

ToS refers to using the three precedence bits of the ToS field in an IP packet to specify a priority value ranging from 0 (lowest) to 7 (highest).

DiffServ uses the DiffServ Code Point (DSCP) value specified in the first 6 bits of the ToS field. The DSCP determines the CoS by specifying a per-hop behavior (PHB) for a specific flow or group of flows. The PHB indicates the forwarding behavior of a flow by specifying bandwidth, queueing schemes, and criteria for dropping packets.

- **Layer 2 802.1p Priority**

The 802.1p priority value is specified in the Tag Control Info (TCI) field of an Ethernet frame. This value also ranges from 0 (lowest) to 7 (highest) and maps to the ToS precedence values.

The OmniSwitch output queuing capability uses these CoS values to determine the forwarding treatment by prioritizing flows based on application and network requirements. For more information about output queue (congestion) management, see [“Congestion Management” on page 27-9](#).

How Traffic is Classified and Marked

The OmniSwitch provides the following tools and techniques for classifying network traffic:

- **QoS Policy Rules**

A policy (or a *policy rule*) is made up of a condition and an action. The condition specifies parameters that the switch examines in incoming flows, such as destination address or Type of Service (ToS) bits. The action specifies what the switch does with a flow that matches the condition; for example, it can queue the flow with a higher priority, or reset the ToS bits. See [“QoS Policy Overview” on page 27-21](#) for more information.

- **Access Control Lists (ACLs)**

ACLs are QoS policies used to control whether or not packets are allowed or denied at the switch or router interface. ACLs are sometimes referred to as filtering lists and may also specify priority-setting actions. See [“Using Access Control Lists” on page 27-55](#) for more information.

- **Port-based QoS**

Individual ports are configured to either trust (recognize) or not trust (do not recognize) existing 802.1p or ToS/DSCP values within a packet or to apply a user-defined default classification value. Port-based QoS often works in conjunction with QoS policy rules to prioritize packet flows. By default, all switch ports are untrusted. See [“Configuring Trusted Ports” on page 27-7](#) for more information.

When packets ingress on a switch port, the packets are classified and marked as follows:

- If a packet matches a QoS policy rule that sets a new priority value (802.1p or ToS/DSCP), the egress priority for the packet is set using the value specified in the rule.
- If a packet ingresses on a *trusted* port and does not match any QoS policy that sets priority, then the existing 802.1p value (non-IP packets) or the ToS/DSCP value (IP packets) or the default classification priority configured for the port is used to determine priority for the packet.
- If a packet ingresses on an *untrusted* port and does not match any QoS policy that sets priority, then the the default 802.1p value configured for the port (tagged/untagged non-IP packets) or the default ToS/DSCP value configured for the port (IP packets) is used to determine priority for the packet.
- If the default classification value for the port is set to DSCP, the DSCP value of a tagged IP packet is mapped to the 802.1p value for that same packet. In other words, the 802.1p priority is overwritten with the precedence bits of the DSCP value. This does not apply to Layer 2 packets. See [“Maintaining the 802.1p Priority for IP Packets” on page 27-56](#) for more information.
- The egress priority for a packet ingressing on a VLAN Stacking port (a trusted port) is set using the existing 802.1p value or configured through an associated VLAN Stacking service.
- IP phone traffic is automatically trusted by default. See [“Automatic QoS Prioritization for IP Phone Traffic” on page 27-5](#) for more information.

Classifying Bridged Traffic as Layer 3

In some network configurations it is required to force the switch to classify bridged traffic as routed (Layer 3) traffic. Typically this option is used for QoS filtering. See [“Using Access Control Lists” on page 27-55](#) for more information about filtering.

The Layer 3 classification of bridged traffic is no different from the classification of normal Layer 3 routed traffic. Note that this implementation of QoS always performs Layer 3 classification of bridged traffic; it is not an option. As a result,

- Layer 3 ACLs are always effected on bridged traffic.
- The switch can bridge and route traffic to the same destination.
- All IP packets are prioritized based on ToS if the default classification on the port is set to DSCP. If DSCP is not the default classification, then the IP packets are prioritized based on 802.1p.

Note that Layer 3 ACLs are effected on bridged IP traffic and Layer 2 ACLs are effected on routed traffic.

Automatic QoS Prioritization for IP Phone Traffic

Automatic QoS prioritization refers to prioritizing certain subsets of switch traffic without having to configure a specific QoS policy to do the same for each type of traffic. This functionality is currently available for IP phone traffic.

The switch automatically trusts the priority of IP phone traffic by default. This means that the priority value contained in packets originating from IP phones is used for the ingress priority. The default priority value configured for the QoS port receiving such traffic is used for the egress priority of the packet.

IP phone traffic is detected by examining the source MAC address of the packet to determine if the address falls within the following ranges of IP phone MAC addresses:

00-80-9F-54-xx-xx to 00-80-9F-64-xx-xx
00-80-9F-66-xx-xx to 00-80-9F-6F-xx-xx.

In addition to prioritizing IP phone traffic, it is also possible to automatically prioritize non-IP phone traffic. This is done by adding up to four MAC addresses or four ranges of MAC addresses to the predefined QoS “alaPhone” MAC address group. See [“Creating MAC Groups” on page 27-49](#) for more information.

Configuring Automatic Prioritization for IP Phone Traffic

The switch trusts the priority of IP phone traffic by default. This means, when the IP phone traffic is trusted, the ingress priority on the packet is trusted. This implies that the priority value contained in packets originating from IP phones is used for the ingress priority. In addition to trusting, it is possible to opt prioritization of IP phone traffic. The default priority value configured for the QoS port receiving such traffic is used for the egress priority of the packet.

IP phone traffic is detected by examining the source MAC address of the packet, to determine if the address falls within the following ranges of IP phone MAC addresses:

```
00-80-9F-xx-xx-xx or 00-13-FA-xx-xx-xx
```

In addition to prioritizing IP phone traffic, it is also possible to automatically prioritize non-IP phone traffic. This is done by adding up to four MAC addresses or four ranges of MAC addresses to the predefined QoS “alaPhone” MAC address group. See [“Creating MAC Groups” on page 27-49](#) for more information.

The **qos phones** command is used to enable or disable automatic prioritization of IP phone traffic. In addition, this command also specifies whether to trust the IP phone traffic (the default) or apply a specified priority value to the traffic. For example, the following command specifies a priority value to apply for ingress IP phone traffic:

```
-> qos phones priority 1
```

To trust IP phone traffic, enter the following command:

```
-> qos phones trusted
```

To disable automatic IP phone traffic prioritization for the switch, enter the following command:

```
-> qos no phones
```

The QoS IP phone prioritization and Sip-Snooping features are mutually exclusive. The RTP/RTCP (Real-time Transfer Protocol/Real-time Transfer Control Protocol) packets are treated based on QoS IP phone FFP rule, because MAC addresses can be in 00-80-9F-xx-xx-xx range. If QoS IP phone prioritization feature is enabled when Sip-Snooping feature is enabled, an error message is displayed and vice versa. Hence, to enable QoS IP phone prioritization disable Sip-Snooping feature using **sip-snooping admin-state disable** command. Similarly, to enable Sip-Snooping feature disable QoS IP phone prioritization feature using **qos no phones** command.

Note. Notes:

- QoS IP phone prioritization is configured, by default, on initialization.
 - When automatic prioritization of IP phone traffic is enabled, QoS policies that specify priority are not applied to the IP phone traffic. Other QoS policies, however, are applied to this type of traffic as usual. If a policy specifies rate limiting, then the policy with the lowest rate limiting value is applied.
-

Prioritizing CPU Packets

In addition to physical switch ports, each NI has an internal CPU interface that handles traffic sent to or from the CPU (for example, BPDU and LAG PDUs). Such packets go directly to the CPU through a set of queues without traversing the switch fabric. In addition, packets from the CPU go directly to local ports without going through the fabric.

The QoS CPU priority policy action is used in a policy to assign a priority value to traffic destined for the CPU. See the [policy action cpu priority](#) command page in the *OmniSwitch AOS Release 8 CLI Reference Guide* for more information.

Configuring Trusted Ports

By default switch ports are *untrusted*; that is, they do not recognize 802.1p or ToS/DSCP settings in packets of incoming traffic. When a port is untrusted, the switch sets the 802.1p or ToS/DSCP bits in incoming packets to the default 802.1p or DSCP values configured for that port.

The [qos port default 802.1p](#) and [qos port default dscp](#) commands are used to specify the default 802.1p and ToS/DSCP values. If no default is specified, then these values are set to zero.

Ports must be *both trusted and configured for 802.1Q* traffic in order to accept 802.1p traffic.

The following applies to ports that are trusted:

- The 802.1p or ToS/DSCP value is preserved.
- If the incoming 802.1p or ToS/DSCP flow does not match a policy, the switch places the flow into a default queue and prioritizes the flow based on the 802.1p or ToS/DSCP value in the flow.
- If the incoming 802.1p or ToS/DSCP flow matches a policy, the switch queues the flow based on the policy action.

The port trust setting can be configured globally or on a per-port basis to override the global setting.

To configure the global setting on the switch, use the [qos trust-ports](#) command. For example:

```
-> qos trust ports
```

To configure individual ports as trusted, use the [qos port trusted](#) command with the desired chassis/slot/port number. For example:

```
-> qos port 1/3/2 trusted
```

The global setting is active immediately; however, the port setting requires **qos apply** to activate the change. See [“Applying the Configuration” on page 27-63](#) for more information.

To display information about QoS ports, such as whether or not the port is trusted, use the [show qos port](#) command. For example:

```
-> show qos port
Chassis
Slot/      Default   Default
Port  Active Trust P/DSCP Classification  Physical Ingress Egress  DEI      Type
-----+-----+-----+-----+-----+-----+-----+-----+-----+-----+-----
1/1/1    No      No  0/ 0          DSCP            0K          -      -    No / No  ethernet
1/1/2    Yes     No  0/ 0          DSCP            1.00G       -      -    No / No  ethernet-1G
1/1/3    No      No  0/ 0          DSCP            0K          -      -    No / No  ethernet
1/1/4    No      No  0/ 0          DSCP            0K          -      -    No / No  ethernet
1/1/5    No      No  0/ 0          DSCP            0K          -      -    No / No  ethernet
```

1/1/6	No	No	0/ 0	DSCP	0K	-	-	No / No	ethernet
1/1/7	No	No	0/ 0	DSCP	0K	-	-	No / No	ethernet
1/1/8	No	No	0/ 0	DSCP	0K	-	-	No / No	ethernet
1/1/9	No	No	0/ 0	DSCP	0K	-	-	No / No	ethernet
1/1/10	No	No	0/ 0	DSCP	0K	50K	-	No / No	ethernet
1/1/11	No	*Yes	0/ 0	*802.1P	0K	-	-	No / No	ethernet
1/1/12	No	*Yes	0/ 0	*802.1P	0K	-	-	No / No	ethernet

Using Trusted Ports With Policies

Whether or not the port is trusted is important if you want to classify traffic with 802.1p bits. If the policy condition specifies 802.1p, the switch must be able to recognize 802.1p bits. (Note that the trusted port must also be 802.1Q-tagged). The 802.1p bits can be set or mapped to a single value using the [policy action 802.1p](#) command.

In the following example, the **qos port** command specifies that port 2 on slot 3 are able to recognize 802.1p bits. A policy condition (**Traffic**) is then created to classify traffic containing 802.1p bits set to 4 and destined for port 2 on slot 3. The policy action (**SetBits**) specifies that the bits are reset to 7 when the traffic egresses the switch. A policy rule called **Rule2** puts the condition and the action together.

```
-> qos port 1/3/2 trusted
-> policy condition Traffic destination port 1/3/2 802.1p 4
-> policy action SetBits 802.1p 7
-> policy rule Rule2 condition Traffic action SetBits
```

To activate the configuration, enter the **qos apply** command. See [“Applying the Configuration” on page 27-63](#) for more information.

For actions that set 802.1p bits, note that a limited set of policy conditions are supported. See [“Condition and Action Combinations” on page 27-25](#) for more information.

Note. 802.1p mapping can also be set for Layer 3 traffic, which typically has the 802.1p bits set to zero.

Congestion Management

Queuing mechanisms are used to manage congestion on egress ports. When congestion occurs, packets are prioritized and placed into queues based on the CoS markings assigned to the packets during classification. If there is no congestion on the egress port, packets are sent out as soon as they are received.

There are eight egress queues allocated for each port on an OmniSwitch. Traffic management and QoS scheduling for these queues is done through the use of pre-defined Queue Set Profiles (QSPs). For more information, see [“Queue Sets” on page 27-9](#) and [“QSet Profiles” on page 27-10](#).

Queue Sets

The queue management and related QoS functions are implemented using a framework based on Queue Sets (QSets). A QSet is a set of eight egress port queues that are associated with each switch port.

The QSET framework involves the following elements:

- **QSet instance (QSI)**—A QSI is a logical entity that refers to a set of eight queues. Each port in the switch is automatically associated with a QSI.
- **QSet profile (QSP)**—a profile associated with each QSI that defines the output scheduling behavior for the queues associated with the QSet instance. There are four pre-defined QSPs, with QSP 1 serving as the default profile that is automatically assigned to each QSI. See [“QSet Profiles” on page 27-10](#).

When a physical switch port comes up, a QSet instance (a set of eight queues) is automatically associated with the port for unicast traffic. In addition, the default QSet profile (QSP 1) is automatically assigned to the QSI.

If a port attaches to a link aggregate (LAG), a QSI and default QSP 1 are automatically associated with the LAG ID. Each time a port joins the LAG, the QSI for the port is imported into the LAG. When this occurs, the LAG QSI becomes the parent and the member port QSI is the child. Note that when a member port leaves a LAG, the QSI and profile for the port reverts back to the default values.

The following example diagram demonstrates the relationship between switch ports, QSet instances, and profiles. See [“QSet Profiles” on page 27-10](#) for more information.

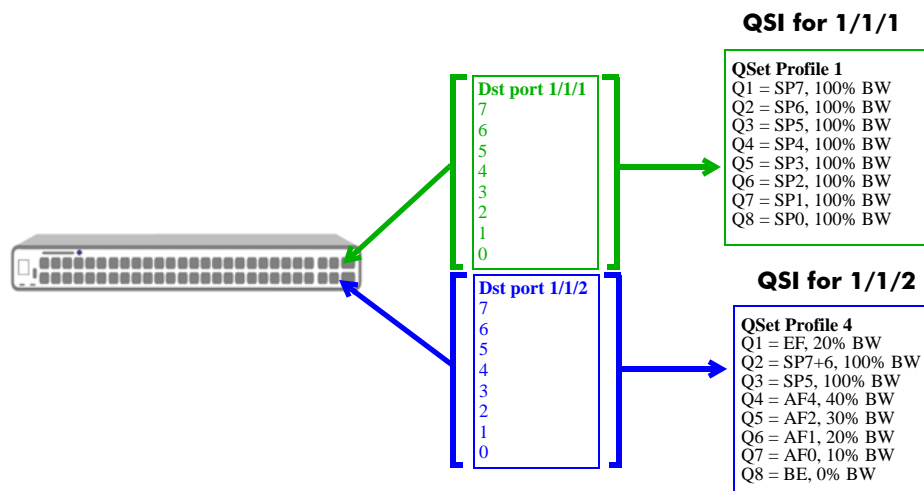

In this example illustration:

- Ingress packets destined for port 1/1/1 and port 1/1/2 are queued into CoS queues.
- The centralized scheduler maintains a QSI for port 1/1/1 and port 1/1/2.
- The QSP assigned to the QSI for port 1/1/1 and port 1/1/2 is applied by the scheduler to all flows destined for port 1/1/1 or port 1/1/2.
- There are four pre-defined QSPs supported. In this example, the default QSP 1 is associated with the QSI for port 1/1/1. However, QSP 4 was assigned to the QSI for port 1/1/2.

QSet Profiles

There are four pre-defined QSet profiles (QSP 1 - 4) supported. Each profile defines the following bandwidth management attributes that are applied to traffic destined for the port or link aggregate QSet instance associated with the profile:

- The percentage of bandwidth allocated for and shared by all of the QSet queues. This value is taken from the port to which the QSet profile is applied (either port speed or the user-defined bandwidth for the port is used).
- The administrative status of statistics collection for the QSet queues.
- The queue specific (QSpec) priority used for output scheduling on each of the eight QSet queues.

The following four pre-defined QSet profiles are supported:

QSP	Bandwidth	Queue Specific Priority
QSP 1	100%	8 SP
QSP 2	100%	1 EF, 7 SP
QSP 3	100%	1 EF, 7 WFQ
QSP 4	100%	1 EF, 2 SP, 4 AF, 1 BE

To determine how flows are mapped to the egress queues based on ingress priority markings, see the [“QSet Profile Mapping” on page 27-11](#). This section contains CoS priority mapping tables for each QSet profile.

Configuring QSet Profiles

The default QSet profile (QSP 1) is automatically assigned to each QSet instance when a port goes active or a port joins a LAG. It is only necessary to assign a different profile if QSP 1 attributes are not sufficient.

Consider the following when configuring a QSet profile:

- QSP 1, 2, 3, and 4 are predefined profiles that are not modifiable and cannot be deleted from the switch configuration.
- Creating a new profile is not supported; only the four pre-defined profiles are available at this time.
- There is only one QSP assigned to each QSet instance and only one QSet instance per port or link aggregate (LAG). However, a LAG may show multiple QSet instances, one for each port that is a member of the LAG.
- When a port leaves a LAG, the default QSP 1 profile is associated with the QSet instance for that port. In other words, if the QSet instance for a port was associated with QSP 4 when the port joined the LAG, the port is associated with QSP 1 when it leaves the LAG.

The **qos qsi qsp** command is used to change the QSP for a specific QSet instance (QSI). For example:

```
-> qos qsi port 1/1/2 qsp 2
-> qos qsi port 1/2/1-10 qsp 3
-> qos qsi linkagg 5 qsp 3
```

To view the QSet profile configuration for the switch, use the **show qos qsp** command.

See the *OmniSwitch AOS Release 8 CLI Reference Guide* for more information about the **qos qsi qsp** and related **show** commands.

QSet Profile Mapping

This section contains a unicast queue mapping table for each of the four pre-defined QSet profiles (QSPs). By default, each QSet port instance is associated with QSP 1. See [“Multicast and Unicast Traffic Distribution” on page 27-12](#) for more information.

Default QSet Profile 1 (8 SP)

Queue ID	Queue Type	Scheduling	Weight	802.1p	ToS	DSCP	Notes
8	SP7	SP	100%	7	7	7.x	Straight SP7
7	SP6	SP	100%	6	6	6.x	Straight SP6 with starvation
6	SP5	SP	100%	5	5	5.x, 5.6	Straight SP5 with starvation (“unprotected” EF)
5	SP4	SP	100%	4	4	4.x	Straight SP4 with starvation
4	SP3	SP	100%	3	3	3.x	Straight SP3 with starvation
3	SP2	SP	100%	2	2	2.x	Straight SP2 with starvation
2	SP1	SP	100%	1	1	1.x	Straight SP1 with starvation
1	SP0	SP	100%	0	0	0	Straight SP0 with starvation

QSet Profile 2 (1 EF + 7 SP)

Queue ID	Queue Type	Scheduling	Weight	802.1p	ToS	DSCP	Notes
8	EF	SP	20%	X(5)	X(5)	5.6	Protected EF
7	SP7+SP6	SP	100%	7, 6	7, 6	7.x, 6.x	Straight SP 7 and 6 max (effective CIR = PR minus EF PIR)
6	SP5	SP	100%	5	5	5.x	Straight SP5 with starvation
5	SP4	SP	100%	4	4	4.x	Straight SP4 with starvation
4	SP3	SP	100%	3	3	3.x	Straight SP3 with starvation
3	SP2	SP	100%	2	2	2.x	Straight SP2 with starvation
2	SP1	SP	100%	1	1	1.x	Straight SP1 with starvation
1	SP0	SP	100%	0	0	0	Straight SP0 with starvation

QSet Profile 3 (1 EF + 7 WFQ)

Queue ID	Queue Type	Scheduling	Weight	802.1p	ToS	DSCP	Notes
8	EF	SP	20%	X(5)	X(5)	5.6	Protected EF
7	WFQ7+6	WFQ	20%	7, 6	7, 6	7.x, 6.x	WFQ
6	WFQ5	WFQ	12%	5	5	5.x	WFQ
5	WFQ4	WFQ	12%	4	4	4.x	WFQ
4	WFQ3	WFQ	12%	3	3	3.x	WFQ
3	WFQ2	WFQ	38%	2	2	2.x	WFQ
2	WFQ1	WFQ	4%	1	1	1.x	WFQ
1	WFQ0	WFQ	2%	0	0	0	WFQ

QSet Profile 4 (1 EF + 2 SP + 4 AF + 1 BE)

Queue ID	Queue Type	Scheduling	Weight	802.1p	ToS	DSCP	Notes
8	EF	SP	20%	X(5)	X(5)	5.6	Protected EF
7	SP7+6	SP	100%	7, 6	7, 6	7.x, 6.x	SP 7 with effective CIR = PR minus EF PIR
6	SP5	SP	100%	5	5	5.x	SP 6 with effective CIR = PR minus EF PIR (starvable) "Mission Critical" data/video
5	AF4	WFQ	40%	x	x	4.1, 4.2, 4.3	AF4 WFQ (starvable)
4	AF3	WFQ	30%	x	x	3.1, 3.2, 3.3	AF3 WFQ (starvable)
3	AF2	WFQ	20%	x	x	2.1, 2.2, 2.3	AF2 WFQ (starvable)
2	AF1	WFQ	10%	x	x	1.1, 1.2, 1.3	AF1 WFQ (starvable)
1	BE	WFQ	0%	4, 3, 2, 1, 0	4, 3, 2, 1, 0	4.0, 3.0, 2.0, 1.0, 0.0	BE not guaranteed

Multicast and Unicast Traffic Distribution

The multicast and unicast queue mapping is as follows:

Queues	Priority	Precedence
UC7, MC7	7	Highest
UC6, MC6	6	
UC5, MC5	5	
UC4, MC4	4	
UC3, MC3	3	
UC2, MC2	2	
UC1, MC1	1	
UC0, MC0	0	Lowest

Traffic Policing and Shaping

Traffic policing and shaping mechanisms are used to limit the rate of traffic. The main difference between the two is how they handle traffic that violates the specified rate. Policing either drops or remarks traffic that exceeds a configured maximum rate. Shaping delays the transmission of packets that exceed configured rates by placing the packets in a queue and scheduling them to be sent at a later time.

The OmniSwitch provides the following techniques for policing and shaping traffic flows.

Policing

- **QoS Tri-Color Marking (TCM) policy.** A TCM policy consists of a policy action that specifies packet rates and burst sizes. The policy condition defines the type of traffic for TCM to meter and then color mark (green, yellow, or red) based on conformance with the rate limits defined in the policy action. See [“Tri-Color Marking” on page 27-14](#).
- **QoS bandwidth policy actions.** Maximum bandwidth and depth policy actions are used in QoS policy rules to specify a maximum ingress bandwidth rate and bucket size. See [“Configuring Policy Bandwidth Policing” on page 27-17](#) for more information.
- **E-Services bandwidth parameters.** The VLAN Stacking Service Access Point (SAP) profile defines an ingress and egress bandwidth rate limiting configuration for an Ethernet Service. See [Chapter 36, “Configuring VLAN Stacking,”](#) for more information.
- **Universal Network Profile (UNP) bandwidth parameters.** UNP Edge and VLAN profiles define an ingress and egress bandwidth rate limiting configuration for UNP ports that are assigned to the Edge or VLAN profile. See [Chapter 31, “Configuring Access Guardian,”](#) for more information.

Shaping

- **Port-based QoS bandwidth shaping.** The QoS CLI provides two commands for setting the maximum ingress and egress bandwidth for a specific port. These QoS port parameters define the rate at which traffic is received and sent on the specified port. See [“Configuring Policy Bandwidth Policing” on page 27-17](#).
- **Queue bandwidth shaping.** Queuing mechanisms are used to manage congestion on egress ports. There are eight egress queues allocated for each port on an OmniSwitch. Traffic management and QoS scheduling for these queues is done through the use of pre-defined Queue Set Profiles (QSPs). See [“Congestion Management” on page 27-9](#) for more information.

Tri-Color Marking

This implementation of a Tri-Color Marking (TCM) provides a mechanism for policing network traffic by limiting the rate at which traffic is sent or received on a switch interface. The TCM policier meters traffic based on user-configured packet rates and burst sizes and then marks the metered packets as green, yellow, or red based on the metering results.

The following diagram illustrates the basic operation of TCM:

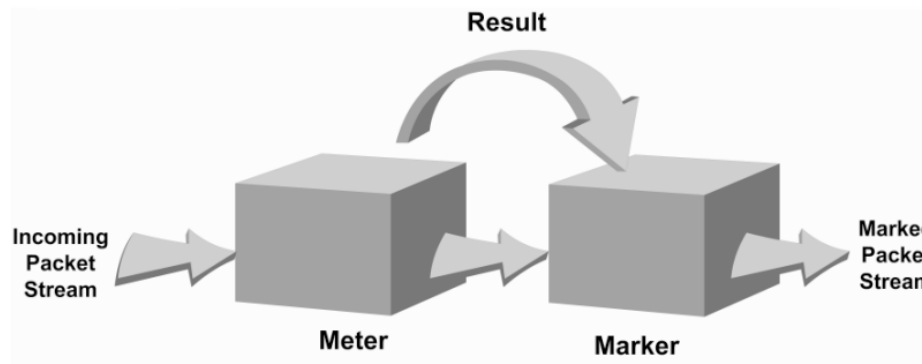

The TCM policier meters each packet and passes the metering result along with the packet to the Marker. Depending upon the result sent by the Meter, the packet is then marked with either the green, yellow, or red color. The marked packet stream is then transmitted on the egress based on the color-coded priority assigned.

The TCM Meter operates in Color-Blind mode (the Color-Aware mode is not supported). In the Color-Blind mode, the Meter assumes that the incoming packet stream is uncolored.

There are two types of TCM marking supported:

- Single-Rate TCM (srTCM)—Packets are marked based on a Committed Information Rate (CIR) value and two associated burst size values: Committed Burst Size (CBS) and Peak Burst Size (PBS).
- Two-Rate TCM (trTCM)—Packets are marked based on a CIR value *and* a Peak Information Rate (PIR) value and two associated burst size values: CBS and PBS.

Both srTCM and trTCM operate in the same basic manner, as shown in the above diagram. The main difference between the two types is that srTCM uses one rate limiting value (CIR) and trTCM uses two rate limiting values (CIR and PIR) to determine packet marking.

The type of TCM used is determined when the policier is configured; depending on which rates and burst size values are configured, TCM functions in either single-rate or two-rate mode. There is no explicit command to select the type of TCM. See [“Configuring Tri-Color Marking” on page 27-15](#) for more information.

Based on the TCM type used, packets are marked as follows:

TCM Type	Meter Compliance	Marker Color	Result
Single-Rate (srTCM)	Packet is CIR/CBS compliant.	GREEN	Packet is transmitted with the Drop Precedence set to LOW.
	Packet is not CIR/CBS compliant but is CIR/PBS compliant.	YELLOW	Packet is transmitted with the Drop Precedence set to HIGH (packet is dropped first when congestion occurs on the egress queue.
	Packet is neither CIR/CBS nor CIR/PBS compliant.	RED	Packet is dropped at the ingress.
Two-Rate (trTCM)	Packet is CIR/CBS compliant.	GREEN	Packet is transmitted with the Drop Precedence set to LOW.
	Packet is not CIR/CBS compliant but is PIR/PBS compliant.	YELLOW	Packet is transmitted with the Drop Precedence set to HIGH (packet is dropped first when congestion occurs on the egress queue.
	Packet is neither CIR/CBS nor PIR/PBS compliant.	RED	Packet is dropped at the ingress.

Configuring Tri-Color Marking

Tri-Color Marking (TCM) is a supported technique for policing traffic. See [“Tri-Color Marking” on page 27-14](#) for an overview of how this implementation of TCM works.

Configuring TCM is done by creating a TCM policy action using the following QoS **policy action** command parameters:

- **cir** (Committed Information Rate, in bits per second)
- **cbs** (Committed Burst Size, in bytes)
- **pir** (Peak Information Rate, in bits per second)
- **pbs** (Peak Burst Size, in bytes)
- **color-only** (mark packet color only)

Consider the following when configuring TCM policy actions:

- There is no explicit CLI command to specify the mode in which the TCM meter operates. This mode is determined by whether or not the PIR is configured for the policy action and if the value of the PIR is greater than the value of the specified CIR. In this case, the trTCM mode is triggered; otherwise, the srTCM mode is used.
- This implementation of TCM is in addition to the basic rate limiting capabilities provided through the maximum bandwidth and maximum depth parameters used in QoS policy actions and the ingress and egress bandwidth parameters used in VLAN Stacking Service Access Point (SAP) profiles. When these parameters are used, the TCM meter operates in the Single-Rate TCM mode by default.
- A srTCM policy action specifies both a CBS and PBS value. Default values for these burst sizes are used if one is not specified using the optional **cbs** and **pbs** parameters.
- Configure the PBS and CBS with a value that is greater than or equal to the size of the largest IP packet in the metered stream.

To configure a TCM QoS policy action, use the **policy action cir** command with one or more of the above parameters. Configuring the **cbs** and **pbs** parameters is optional. If a value is not specified for either one, the default value is used for both parameters. For example:

```
-> policy action A1 cir 10M
```

To specify one or both of the burst size values, use the **cbs** and **pbs** parameters. For example:

```
-> policy action A2 cir 10m cbs 4k
-> policy action A3 cir 10m cbs 4k pbs 10m
```

All of these command examples configure the TCM meter to operate in the Single-Rate TCM (srTCM) mode. To configure the meter to operate in the Two-Rate TCM (trTCM) mode, use the **pir** parameter and specify a peak information rate value that is greater than the committed information rate value. For example, the following commands configure the meter to use the trTCM mode:

```
-> policy action A4 cir 10m cbs 4k pir 20m
-> policy action A5 cir 10m cbs 4k pir 20m pbs 40m
```

Once a TCM policy action is configured, the action can be used in a policy rule to rate limit traffic according to the specified rates and burst sizes. Traffic that matches a TCM policy is marked green, red, or yellow based on the rate limiting results.

To remove the TCM configuration from a QoS policy action, use the **no** form of the **policy action cir** command. For example:

```
-> policy action A6 no cir
```

TCM Policy Example

Once configured, a TCM policy action is then available to use in a QoS policy rule to apply color marking to a specified traffic stream.

First, create a condition for the traffic. In this example, the condition is called **ip_traffic**. A policy action (**tcml**) is then created to enforce ingress rate limiting using TCM.

```
-> policy condition ip_traffic source ip 10.10.5.3
-> policy action tcml cir 5m cbs 4k pir 10m pbs 20m counter-color green-nongreen
-> policy rule rule1 condition ip_traffic action tcml
```

Note that the rates and burst sizes can be specified in abbreviated units, in this case, **10m**.

The rule is not active on the switch until the **qos apply** command is entered. When the rule is activated, any flows coming into the switch from source IP address 10.10.5.3 is metered and marked according to the TCM policier parameters specified in the **tcml** policy action.

Setting the DEI Bit

The Drop Eligible Indicator (DEI) bit setting is applied to packets marked yellow (non-conforming) as the result of Tri-Color Marking (TCM) rate limiting. The TCM policier meters traffic based on user-configured packet rates and burst sizes and then marks the metered packets as green, yellow, or red based on the metering results. See [“Configuring Tri-Color Marking” on page 27-15](#) for more information.

Yellow packets are assigned a high drop precedence, which means they are dropped first when the egress port queues become congested. If there is no congestion on the queues, however, yellow packets are retained and forwarded along to the next switch. When this occurs, the receiving switch does not know that the packet was marked yellow by the transmitting switch.

Setting the DEI bit for yellow egress packets ensures that the upstream switch is made aware that the packet was marked yellow. The upstream switch can then decide to drop the DEI marked packets first when the network is congested. When a switch receives a yellow packet with the DEI bit set and DEI mapping is enabled, the packet is mapped to an internal drop precedence or yellow color marking for the switch.

When the default QoS classification value is set to DSCP, the DEI bit is not relevant for DSCP packets. As a result, the color/congestion is derived from the values carried in the DSCP bit, not from the incoming DEI. However, if the default QoS classification is set to 802.1p, the DEI/CFI is honored for both Layer 2 and Layer 3 traffic.

The switch can be set globally so that DEI bit marking and mapping is enabled for all ports. Individual ports can be configured to override the global setting

Configuring the DEI Bit Setting

By default, DEI bit marking (egress) and mapping (ingress) is disabled on all switch ports. The DEI bit setting operation can be configured globally on the switch, or on a per-port basis.

To configure the global DEI bit setting operation to mark traffic egressing on QoS destination ports, use the **qos dei** command with the **egress** parameter option. For example:

```
->qos dei egress
```

To configure the switch to map ingress traffic marked with the DEI bit, use the **qos dei** command with the **ingress** parameter option. For example:

```
-> qos dei ingress
```

To configure the DEI bit operation for an individual port, use the **qos dei** with the **ingress** or **egress** parameter option. For example:

```
-> qos port 1/1/10 dei egress  
-> qos port 1/1/11 dei ingress
```

See the *OmniSwitch AOS Release 8 CLI Reference Guide* for more information about these commands.

Configuring Policy Bandwidth Policing

The **policy action maximum bandwidth** and **policy action maximum depth** commands are used to configure QoS policy actions. Both actions are typically used in combination; the bucket size (depth) determines how much over the maximum bandwidth the traffic can burst.

The maximum bandwidth and maximum depth actions are configured as part of a QoS policy in which the condition specifies the type of traffic to rate limit. Maximum bandwidth policies are applied to source (ingress) ports and/or flows. See the [“Bandwidth Policing Example” on page 27-67](#).

Port Groups and Maximum Bandwidth

If a port group condition (see [“Creating Port Groups” on page 27-50](#)) is used in a maximum bandwidth policy, the bandwidth value specified is shared across all ports in the group. This also applies to flows that involve more than one port. For example, if a policy specifies a maximum bandwidth value of 10M for a port group containing 4 ports, the total bandwidth limit enforced is 10M for all 4 ports.

Note the following when configuring ingress maximum bandwidth policies:

- If a policy condition applies to ports that are located on different slots, the maximum bandwidth limit specified is multiplied by the number of slots involved. For example, if a rule is configured to apply a maximum bandwidth limit of 10M to ports 1/1/1, 1/3/10, and 1/4/5, then the actual bandwidth limit enforced for all three ports is 30M.
- If a policy condition applies to ports that are all on the same slot, then the maximum bandwidth value specified in the rule is not increased.
- Ingress bandwidth limiting is done using a minimum granularity of an 8Kbps, depending on the port rate (for example, 1G, 10G, or 40G).
- The **show active policy rule** command displays green, yellow, and red packet and bytes counters based on the rate-limit policy action parameter.
- Rate limiting is done on a per-slot, per-chassis basis. So if a port group consists of multiple chassis or slot ports, then the configured rate-limit policy action is shared among the slot/chassis ports in the port group.
- Although bandwidth policies are applied to ingress ports, it is possible to specify a destination port or destination port group in a bandwidth policy as well. Doing so, effects egress rate limiting/egress policing on the ingress port itself. The limitation of bridged port traffic only on destination ports applies in this case as well.

The following subsections provide examples of ingress maximum bandwidth policies using both source and destination port groups.

Example 1: Source Port Group

In the following example, a port group (**pgroup**) is created with two ports and attached to a policy condition (**Ports**). A policy action with maximum bandwidth is created (**MaxBw**). The policy condition and policy action are combined in a policy rule called **PortRule**.

```
-> policy port group pgroup 1/1/1-2
-> policy condition Ports source port group pgroup
-> policy action MaxBw maximum bandwidth 10k
-> policy rule PortRule condition Ports action MaxBw
```

In this example, if both ports 1 and 2 are active ports, the 10000 bps maximum bandwidth is shared by both ports. In other words, maximum bandwidth policies for port groups define a maximum bandwidth value that is a total bandwidth amount for all ports, not an amount for each port.

Example 2: Destination Port Group

In the following example, a port group (**pgroup2**) is created with several ports and attached to a policy condition (**Ports2**). A policy action with maximum bandwidth is created (**MaxBw**). The policy condition and policy action are combined in a policy rule called **PortRule2**.

```
-> policy port group pgroup2 1/1/1 1/1/25 1/2/1
-> policy condition Ports2 destination port group pgroup2
-> policy action MaxBw maximum bandwidth 10k
-> policy rule PortRule2 condition Ports2 action MaxBw
```

The maximum traffic received by a destination port is dependent on how many slots are sending traffic to the destination port. However, each slot is restricted to sending only 10k.

In this example, the specified ports for **pgroup2** span across two slots. As a result, the maximum bandwidth limit specified by the policy action is increased to 20K for all of the ports. The bandwidth limit is increased by multiplying the number of slots by the specified bandwidth value.

Per-Port Rate Limiting with Source Port Groups

How the rate limiting actions are applied to group ports is determined by the type of source port group specified by the policy rule condition. There are two types of configurable source port group policy conditions: group and split-group. Both types of group conditions represent an aggregate of member ports. The difference between the two types is how rate limiting actions are applied to the member ports.

- **A regular source port group.** When this type of group is defined as a condition for a policy rule, any rate limiter actions in that rule are applied to the group as a whole. All ports in that group share the rate limiting values. For example, if a maximum bandwidth value of 10M is applied, the member ports of that group share the 10M maximum bandwidth value per-slot, per-chassis.
- **A source port split-group.** When this type of group is defined as a condition for a policy rule, any rate limiter actions in that rule are applied to each member port in that group. The rate limiting values are not shared between all the members of the group. For example, if a maximum bandwidth value of 10M is applied, each member port of the split-group is given a maximum bandwidth value of 10M.

The following subsections provide examples of configuring rate limiting policy rules with a source port group condition and with a source port split-group condition.

Configuring a Per-Port Rate Limiting Policy

In the following example, a policy rule (**PortRule**) is configured to rate limit incoming voice traffic on ports to a maximum of 200K bps. This rule uses a Tri-Color Marking (TCM) policy action to rate limit the voice traffic received on ports in the designated source port group (**PGroup**).

```
-> policy port group PGroup 1/1/1-24
-> policy service UDP source udp-port 32000-33000 destination udp port 32000-33000
-> policy network group IP 22.0.0.0 mask 255.0.0.0
-> policy condition SrcPorts source port group PGroup source network group IP destination network group IP dscp 46 service UDP
-> policy action RateLimDscp dscp 46 cir 200K cbs 8K
-> policy rule PortRule condition SrcPorts action RateLimDscp
```

In this example, the TCM rate limiting action (**RateLimDscp**) is applied to all the member ports of the **PGroup** (ports 1/1/1-24) that receive traffic that matches the **SrcPorts** condition parameters. The rate limiting value is shared between the qualifying **PGroup** ports.

If the goal is to apply the **RateLimDscp** action to each qualifying group port on an individual basis (ports do not share the rate limit value applied with other ports), then configuring a separate rule for each port is required. For example:

```
-> policy condition SrcPort1 source port 1/1 source network group IP destination network group IP dscp 46 service UDP
-> policy condition SrcPort2 source port 1/2 source network group IP destination network group IP dscp 46 service UDP
...
-> policy condition SrcPort24 source port 1/24 source network group IP destination network group IP dscp 46 service UDP
-> policy action RateLimDscp dscp 46 cir 20M cbs 8K
-> policy rule PortRule1 condition SrcPort1 action RateLimDscp
-> policy rule PortRule2 condition SrcPort2 action RateLimDscp
...
-> policy rule PortRule24 condition SrcPort24 action RateLimDsc
```

The above configuration is a tedious and time consuming process. However, if the source port group condition is configured as a split-group, then only one policy rule is required to apply rate limiting to each

individual port. For example, the following policy rule configures **SrcPorts** as a source port split-group policy condition:

```
-> policy port group PGroup 1/1/1-24
-> policy service UDP source udp-port 32000-33000 destination udp port 32000-33000
-> policy network group IP 22.0.0.0 mask 255.0.0.0
-> policy condition SrcPorts source port split-group PGroup source network group IP destination network group IP dscp 46 service UDP
-> policy action RateLimDscp dscp 46 cir 20M cbs 8K
-> policy rule PortRule condition SrcPorts action RateLimDscp
```

In this example, all of the qualifying ports in the **PGroup** are rate limited on an individual, per-port basis. This greatly simplifies the configuration process.

When configuring per-port rate limiting with a source port split-group, consider the following guidelines:

- A source port group is the only QoS group that supports the split-group option; other QoS groups (for example, a destination port group or network group) do not support the split-group option.
- A policy rule containing a source port split-group condition can only belong to the default policy list. Assigning this type of rule to other QoS policy lists is not allowed.
- Do not use a shared bandwidth policy action (**policy action shared**) in a policy rule that specifies a source port split-group condition. This type of action shares rate limiting resources with all other rules that contain the same shared policy action. Sharing these resources with rules that contain a split-group condition is not allowed.
- When a source port split-group condition is used, a sub-rule is created for each member port of the split-group. Each sub-rule is assigned a unique split rule ID. For example, if the source port group contains two ports (1/1/2 and 1/1/3) and is configured as a source port split-group condition for a rate limiting policy rule, then two sub-rules (Split Rule ID 1 for port 1/1/2 and Split rule ID 2 for port 1/1/3) are automatically created by the switch to accommodate the per-port rate limiting on each of these two ports.

Use the **show active policy rule** command with the **extended** parameter option to view the sub-rules and related statistics for a policy rule that contains a source port split-group policy condition.

Configuring Port Bandwidth Shaping

QoS supports configuring maximum bandwidth on ingress and egress ports through the **qos port maximum egress-bandwidth** and **qos port maximum ingress-bandwidth** CLI commands. For more information about these commands, see the *OmniSwitch AOS Release 8 CLI Reference Guide*.

Note the following when configuring the ingress or egress bandwidth limit for a port:

- Maximum bandwidth limiting is done using a granularity of 64Kbps. Any value specified that is not a multiple of 64K is rounded up to the next highest multiple of 64K.
- The maximum bandwidth value cannot exceed the maximum bandwidth of the interface type associated with the port.
- Modifying the maximum bandwidth is most useful for low-bandwidth links.
- The configured port-based egress bandwidth limit takes precedence over an egress queue limit configured on the same port.

QoS Policy Overview

A policy (or a *policy rule*) is made up of a condition and an action. The condition specifies parameters that the switch examines in incoming flows, such as destination address or Type of Service (ToS) bits. The action specifies what the switch does with a flow that matches the condition; for example, it can queue the flow with a higher priority, or reset the ToS bits.

Policies can be created directly on the switch through the CLI or WebView or policies can be created on an external LDAP server through the PolicyView application. The switch makes a distinction between policies created on the switch and policies created on an LDAP server.

Note. Note. Policies can only be modified using the same source used to create them. Policies configured through PolicyView can only be edited through PolicyView. Policies created directly on the switch through the CLI or WebView can only be edited on the switch. Policies are created through the CLI or WebView, however, to override policies created in PolicyView. And vice versa.

This section discusses policy configuration using the CLI. For information about using WebView to configure the switch, see the *OmniSwitch AOS Release 8 Switch Management Guide*. For information about configuring policies through PolicyView, see the PolicyView online help.

How Policies Are Used

When a flow comes into the switch, the QoS software in the switch checks to see if there are any policies with conditions that match the flow.

- ***If there are no policies that match the flow***, the flow is accepted and the default QoS port settings for priority are used to classify and mark the flow.
- ***If there is more than one policy that matches the flow***, the policy with the highest precedence is applied to the flow. For more information about policy precedence, see [“Rule Precedence” on page 27-40](#).
- ***Flows must also match all parameters configured in a policy condition***. A policy condition must have at least one classification parameter.

Once the flow is classified and matched to a policy, the switch enforces the policy by mapping each packet of the flow to the appropriate queue and scheduling it on the output port. There are a total of eight queues per port. Traffic is mapped to a queue based on policies, the ToS/802.1p value of the packet, and whether the port is trusted or untrusted. For more information about queues, see [“Congestion Management” on page 27-9](#).

Policy Lists

A QoS policy list provides a method for grouping multiple policy rules together and applying the group of rules to specific types of traffic. The type of traffic to which a policy list is applied is determined by the type of list that is configured. There are two types of policy lists:

- **Default**—All rules are associated with a default policy list when the rules are created. This list is not configurable, but it is possible to direct QoS to not assign a rule to this list.
- **User Network Profile (UNP)**—This type of policy list is associated with the Universal Network Profile (UNP) that is supported on the OmniSwitch 6860. The rules in this list are applied to device traffic that was classified into the profile.

For more information, see [“Creating Policy Lists” on page 27-42](#).

Interaction With Other Features

QoS policies are an integral part of configuring other switch features, such as Link Aggregation. In addition, QoS settings can affect other features in the switch; or QoS settings can require that other switch features be configured in a particular way.

A summary of related features is given here:

- **Dynamic Link Aggregates**—Policies can be used to prioritize dynamic link aggregation groups. For details, see [Chapter 10, “Configuring Dynamic Link Aggregation.”](#)
- **802.1Q**—Tagged ports are always untrusted by default. For information about configuring ports with 802.1Q, see [Chapter 4, “Configuring VLANs.”](#)
- **LDAP Policy Management**—Policies can also be configured through the PolicyView application and stored on an attached LDAP server. LDAP policies can only be modified through PolicyView. For information about setting up a policy server and managing LDAP policies, see [Chapter 28, “Managing Policy Servers.”](#)
- **VLAN Stacking Ethernet Service**—VLAN Stacking ports are always trusted and default classification is set to 802.1p. QoS policy conditions to match the inner VLAN tag and inner 802.1p tag are available for classifying customer information contained in VLAN Stacking frames. For information about VLAN Stacking see [Chapter 36, “Configuring VLAN Stacking.”](#)
- **User Network Profiles**—The Universal Network Profile (UNP) feature provides the ability to assign a list of QoS policy rules to a profile. The rules contained in the list are applied to any device that is assigned to the UNP. For more information about policy lists, see [“Policy Lists” on page 27-22](#) and [Chapter 30, “Configuring Universal Network Profiles.”](#)

Valid Policies

The switch does not allow you to create invalid condition/action combinations; if you enter an invalid combination, an error message is displayed. A list of valid condition and actions is given in [“Policy Conditions” on page 27-23](#) and [“Policy Actions” on page 27-24](#).

It is possible to configure a valid QoS rule that is active on the switch, however the switch is not able to enforce the rule because some other switch function (for example, routing) is disabled.

Policy Conditions

The following conditions are supported and can be combined with other conditions and/or actions:

Supported Policy Conditions Table

Layer 1	Layer 2	Layer 3
destination port destination port group source port source port group	source MAC source MAC group destination MAC destination MAC group 802.1p inner 802.1p ethertype source VLAN source VLAN group inner source VLAN inner source VLAN group destination VLAN (multicast rules only) destination VLAN group (multicast rules only)	IP protocol source IP multicast IP destination IP source network group destination network group multicast network group ToS, DSCP ICMP type, ICMP code source IPv6 destination IPv6 IPv6 traffic IPv6 next header (NH) IPv6 flow label (FL) app-mon-application-group app-mon-application-name
Layer 4	IP Multicast (IGMP)	
source TCP/UDP port destination TCP/UDP port service, service group TCP flags (ECN/CWR are not supported)	destination only	

The CLI prevents you from configuring invalid condition combinations that are never allowed; however, it does allow you to create combinations that are supported in some scenarios. For example, you might configure **source ip** and a **destination ip** for the same condition.

Consider the following guidelines when configuring policy conditions:

- IPv4 and IPv6 conditions cannot be combined.
- Source and destination MAC address conditions cannot be used in IPv6 policy rules.
- The destination VLAN condition is only supported in multicast policy rules.
- IP multicast traffic (not IGMP) is treated as regular traffic; QoS functionality works the same way with this type of traffic, with the exception that the destination port condition does not apply.
- The IP multicast condition works in combination with Layer 1, Layer 2, and Layer 3 destination conditions only if these conditions specify the device that sends the IGMP report packet.
- Source and destination parameters can be combined in Layer 2, Layer 3, and Layer 4 conditions.
- In a given rule, ToS or DSCP can be specified for a condition with priority specified for the action.
- Individual items and their corresponding groups cannot be combined in the same condition. For example, a source IP address cannot be included in a condition with a source IP network group.
- The Layer 1 destination port condition only applies to bridged traffic, not routed traffic.

- Layer 2 and Layer 3 rules are always effected on bridged and routed traffic. As a result, combining source or destination TCP/UDP port and IP protocol in a condition is allowed.
- While configuring an AppMon enforcement policy rule, multiple condition parameters (for example, source IP, destination IP, source VLAN and so on) cannot be defined in a single policy condition along with the application name or group.

For specific information about how to configure policy conditions and actions to create a policy rule, see [“Creating Policies” on page 27-35](#).

Policy Actions

The following actions are supported and can be combined with other actions.

Supported Policy Actions Table

-
- ACL (disposition accept, drop, deny)
 - Priority/CoS
 - 802.1p ToS/DCSP Stamping and Mapping (only applies to the outer 802.1p value; cannot modify the inner value)
 - Maximum Bandwidth
 - Maximum Depth
 - Tri-Color Marking (TCM) Rate Limiting
 - Shared (shares the bandwidth rate between rules that specify the same maximum bandwidth action)
 - Port Redirection
 - Link Aggregate Redirection
 - No Cache (disables the logging of rule entries to the hardware cache)
 - Port Disable
 - Permanent Gateway IPv4/IPv6
 - Mirror
-

The CLI prevents you from configuring invalid action combinations that are never allowed; however, it does allow you to create combinations that are supported in some scenarios. For example, an action specifying maximum bandwidth can be combined with an action specifying priority.

Use the following “Policy Action Combinations Table” together with the [“Supported Policy Actions Table”](#) as a guide when creating policy actions.

Policy Action Combinations Table

	Drop	Priority	Stamp/ Map	Max BW	Redirect Port	Redirect Linkagg	Port Disable	Permanent Gateway IP	Mirror
Drop	N/A	No	No	No	No	No	No	No	Yes
Priority	No	N/A	Yes	Yes	Yes	Yes	No	Yes	Yes
Stamp/Map	No	Yes	N/A	Yes	Yes	Yes	No	Yes	Yes
Max BW	No	Yes	Yes	N/A	Yes	Yes	No	Yes	Yes

Policy Action Combinations Table (continued)

	Drop	Priority	Stamp/ Map	Max BW	Redirect Port	Redirect Linkagg	Port Disable	Permanent Gateway IP Mirror	
Redirect Port	No	Yes	Yes	Yes	N/A	No	No	Yes	Yes
Redirect Linkagg	No	Yes	Yes	Yes	No	N/A	No	Yes	Yes
Port Disable	No	No	No	No	No	No	N/A	No	No
Permanent Gateway IP	No	Yes	Yes	Yes	Yes	Yes	No	N/A	Yes
Mirroring	Yes	Yes	Yes	Yes	Yes	Yes	No	Yes	N/A

For specific information about how to configure policy conditions and actions to create a policy rule, see [“Creating Policies” on page 27-35](#).

Condition and Action Combinations

Conditions and actions are combined in policy rules. The CLI prevents you from configuring invalid condition/action combinations that are never allowed; however, the following table provides a quick reference for determining which condition/action combinations are *not* valid. Each row represents a policy condition or conditions combined with the policy action or actions in the same row.

Policy Condition/Action Combinations

Conditions	Actions	Supported When?
multicast IP address <i>or</i> network group	all actions	never, except with disposition action
multicast IPv6 address	all actions	never, except with disposition and mirror actions
destination VLAN	all actions	never, except with disposition action in a multicast rule (a rule that uses the “multicast” keyword and only applies to IGMP traffic)
destination chassis/slot/port or port group	all actions	bridging only

QoS Defaults

The following tables list the defaults for global QoS parameters, individual port settings, policy rules, default policy rules, and queue management profiles.

Global QoS Defaults

Use the **qos reset** command is to reset global values to their defaults.

Description	Command	Default
QoS enabled or disabled	qos	enabled
Whether ports are globally trusted or untrusted	qos trust-ports	VLAN Stacking ports are always trusted; all other port types are untrusted
Statistics interval	qos stats interval	60 seconds
Level of log detail	qos log level	5
Number of lines in QoS log	qos log lines	10000
Whether log messages are sent to the console	qos log console	no
Whether log messages are available to OmniVista applications	qos forward log	no
Whether IP anti-spoofing is enabled on UserPorts.	qos user-port filter	yes
Whether a UserPorts port is administratively disabled when unwanted traffic is received.	qos user-port shutdown	no
Global default DEI bit setting for ports	qos dei	disabled
Priority for IP Phone connections.	qos phones	trusted Note: QoS reset command will not reset the automatic IP phone priority to the default value, if Sip-Snooping is configured.

QoS Port Defaults

Use the [qos port reset](#) command to reset port settings to the defaults.

Description	Command/keyword	Default
Whether the port is trusted or untrusted	qos port trusted	VLAN Stacking ports are always trusted; all other port types are untrusted.
The maximum egress bandwidth	qos port maximum egress-bandwidth	port bandwidth
The maximum ingress bandwidth	qos port maximum ingress-bandwidth	port bandwidth
The default 802.1p value inserted into packets received on untrusted ports.	qos port default 802.1p	0
The default DSCP value inserted into packets received on untrusted ports.	qos port default dscp	0
The default egress classification value inserted into packets received on trusted ports.	qos port default classification	DSCP (802.1p for VLAN Stacking ports).
The Drop Eligible Indicator (DEI) bit setting.	qos port dei	disabled

Queue Management Defaults

The queue management and related QoS functions are implemented using a Queue Set (QSet) framework. Each port and link aggregate is associated with a set of eight egress queues, referred to as a Queue Set Instance (QSI). Each QSI is associated with QSet profile 1 (QSP 1) by default.

A QSP defines both global parameters for the profile and individual queue profile parameters that are applied to the eight queues associated with the QSet instance. See [“Congestion Management” on page 27-9](#) for more information.

Queue Management Defaults

The following are the default QSet Instance (QSI) settings applied to each port or link aggregate on the:

Port QSI	Default
QSP 1 Admin Status	Enabled
Statistics Admin Status	Disabled
Statistics Interval	10 seconds
Bandwidth	100%

The following are the default QSet Profile (QSP 1) settings applied to each QSI:

QSP 1	Default
Bandwidth	100%
QP1–QP8 Queue Type	Strict Priority
QP1–QP8 CIR PIR	0%, 100%
WFQ Mode	WERR
WFQ Weight	1

Policy Rule Defaults

The following are defaults for the **policy rule** command:

Description	Keyword	Default
Policy rule enabled or disabled	enable disable	enabled
Determines the order in which rules are searched	precedence	0
Whether the rule is saved to flash immediately	save	yes
Whether messages about flows that match the rule are logged	log	no
How often to check for matching flow messages	log interval	60 seconds
Whether to count bytes or packets that match the rule.	count	packets
Whether to send a trap for the rule.	trap	yes (trap sent only on port disable action or UserPort shutdown operation)
Whether the rule is saved to the default list	default-list	yes (all policy rules belong to the default list unless otherwise specified at the time the rule is created)

Policy Action Defaults

The following are defaults for the **policy action** command:

Description	Keyword	Default
Whether the flow matching the rule must be accepted or denied	disposition	accept
Tri-Color Marking (TCM) mode		Single-rate TCM (srTCM) mode
- committed rate and burst size	cir cbs	CIR=0, CBS=10K
- peak rate and burst size	pir pbs	PIR=0, PBS=10K

Note that in the current software release, the **deny** and **drop** options produce the same effect that is, the traffic is silently dropped.

Note. There are no defaults for the **policy condition** command.

Default (Built-in) Policies

The switch includes some built-in policies, or default policies, for particular traffic types or situations where traffic does not match any policies. In all cases, the switch accepts the traffic and places it into default queues.

- *Other traffic*—Any traffic that does not match a policy is accepted.
- *The switch network group*—The switch has a default network group, called **switch**, that includes all IP addresses configured for the switch itself. This default network group can be used in policies. See [“Creating Network Groups” on page 27-46](#) for more information about network groups.

Configuring QoS

QoS configuration involves the following general steps:

1 Configuring Global Parameters. In addition to enabling/disabling QoS, global configuration includes settings such as global port parameters and various timeouts. The type of parameters you might want to configure globally depends on the types of policies you can configure. For example, if you want to set up policies for 802.1p or ToS/DSCP traffic, you can configure all ports as trusted ports.

Typically, you need not change any of the global defaults. See [“Global QoS Defaults” on page 27-26](#) for a list of the global defaults. See [“Configuring Global QoS Parameters” on page 27-31](#) for information about configuring global parameters.

2 Configuring QoS Port Parameters. This configuration includes setting up QoS parameters on a per port basis. Typically you do not need to change the port defaults. See [“QoS Port Defaults” on page 27-27](#) for a list of port defaults. See [“Classification” on page 27-4](#) and [“Traffic Policing and Shaping” on page 27-13](#) for information about configuring port parameters.

3 Configuring Queue Set (QSet) Profiles. The queue management configuration is applied using embedded QSet profiles. A default profile configuration is applied when the switch comes up. Selecting different profiles is only necessary if the default profile settings are not sufficient. See [“Queue Management Defaults” on page 27-27](#) for a list of default profile settings. See [“Congestion Management” on page 27-9](#) for information about configuring QSet profiles.

4 Setting Up Policies. Most QoS configuration involves setting up policies. In addition, policy lists are configurable for use with the Universal Network Profile (UNP) feature. See [“Creating Policies” on page 27-35](#).

5 Applying the Configuration. All policy rule configuration and some global parameters must be specifically applied through the `qos apply` command before they are active on the switch. See [“Applying the Configuration” on page 27-63](#).

Configuring Global QoS Parameters

This section describes the global QoS configuration, which includes enabling and disabling QoS, applying and activating the configuration, controlling the QoS log display, and configuring QoS port and queue parameters.

Enabling/Disabling QoS

By default QoS is enabled on the switch. If QoS policies are configured and applied, the switch attempts to classify traffic and apply relevant policy actions.

To disable the QoS, use the **qos** command. For example:

```
-> qos disable
```

QoS is immediately disabled. When QoS is disabled globally, any flows coming into the switch are not classified (matched to policies).

To re-enable QoS, enter the **qos** command with the **enable** option:

```
-> qos enable
```

QoS is immediately re-enabled. Any policies that are active on the switch are used to classify traffic coming into the switch.

Note that individual policy rules can be enabled or disabled with the **policy rule** command.

Using the QoS Log

The QoS software in the switch creates its own log for QoS-specific events. You can modify the number of lines in the log or change the level of detail given in the log. The PolicyView application, which is used to create QoS policies stored on an LDAP server, query the switch for log events; or log events can be immediately available to the PolicyView application through a CLI command. Log events can also be forwarded to the console in real time.

What Kind of Information Is Logged

The **debug qos** command controls what kind of information is displayed in the log. The **qos log level** command determines how specific the log messages are. See [“Log Detail Level” on page 27-32](#).

By default, only the most basic QoS information is logged. The types of information that can be logged includes rules, Layer 2 and Layer 3 information, etc. For a detailed explanation about the types of information that can be logged, see the **debug qos** command page in the *OmniSwitch AOS Release 8 CLI Reference Guide*. A brief summary of the available keywords is given here:

debug qos keywords

info	sl	classifier
config	mem	sem
rule	mapper	pm
main	slot	ingress
port	l2	egress
msg	l3	

To display information about any QoS rules on the switch, enter **debug qos rule**:

```
-> debug qos rule
```

To change the type of debugging, use **no** with the relevant type of information that you want to remove. For example:

```
-> debug qos no rule
```

To turn off debugging (which effectively turns off logging), enter the following:

```
-> no debug qos
```

Enter the **qos apply** command to activate the setting.

Number of Lines in the QoS Log

By default the QoS log displays a maximum of 10000 lines. To change the maximum number of lines that can display, use the **qos log lines** command and enter the number of lines. For example:

```
-> qos log lines 30
```

The number of lines in the log is changed. To activate the change, enter the **qos apply** command.

Note. If you change the number of log lines, the QoS log can be completely cleared. To change the log lines without clearing the log, set the log lines in the **vcboot.cfg** file; the log is set to the specified number of lines at the next reboot.

Log Detail Level

To change the level of detail in the QoS log, use the **qos log level** command. The log level determines the amount of detail that is given in the QoS log. The **qos log level** command is associated with the **qos debug** command, which determines what kind of information is included in the log.

The default log level is 5. The range of values is 1 (lowest level of detail) to 8 (highest level of detail). For example:

```
-> qos log level 7
```

The log level is changed immediately but the setting is not saved in flash. To activate the change, enter the **qos apply** command. For more information about the **qos apply** command, see [“Applying the Configuration” on page 27-63](#).

Note. A high log level value impacts the performance of the switch.

Forwarding Log Events

NMS applications query the switch for logged QoS events. Use the **qos forward log** command to make QoS log events available to these applications in real time. For example:

```
-> qos forward log
```

To disable log forwarding, enter the following command:

```
-> qos no forward log
```

To activate the change, enter the **qos apply** command. For more information about the **qos apply** command, see [“Applying the Configuration” on page 27-63](#).

If event forwarding is disabled, NMS applications can still query the QoS software for events, but the events are not sent in real time.

Forwarding Log Events to the Console

QoS log messages can be sent to the switch logging utility, which is an event logging application available on the OmniSwitch. The configuration of the switch logging utility then determines if QoS messages are sent to a log file in the switch's flash file system, displayed on the switch console, and/or sent to a remote syslog server.

To send log events to the switch logging utility, enter the following command:

```
-> qos log console
```

To disable immediate forwarding of events to switch logging, enter the following command:

```
-> qos no log console
```

To activate the change, enter the **qos apply** command. For more information about the **qos apply** command, see [“Applying the Configuration” on page 27-63](#).

Use the **swlog output** command to configure switch logging to output logging events to the console. Note that this is in addition to sending log events to a file in the flash file system of the switch. See the “Using Switch Logging” chapter in the *OmniSwitch AOS Release 8 Network Configuration Guide* for more information.

Displaying the QoS Log

To view the QoS log, use the **show qos log** command. The display is similar to the following:

```
**QOS Log**

Insert rule 0
Rule index at 0
Insert rule 1
Rule index at 1
Insert rule 2
Rule index at 2
Enable rule r1 (1) 1,1
Enable rule r2 (0) 1,1
Enable rule yubal (2) 1,1
Verify rule r1(1)
Enable rule r1 (1) 1,1
Really enable r1
Update condition c1 for rule 1 (1)
Verify rule r2(1)
Enable rule r2 (0) 1,1
Really enable r2
Update condition c2 for rule 0 (1)
Verify rule yubal(1)
Enable rule yubal (2) 1,1
Really enable yubal
Update condition yubamac for rule 2 (1)
QoS Manager started TUE MAR 10 13:46:50 2002

Match rule 2 to 1
Match rule 2 to 2
Match rule 2 to 3
```

The log display can be modified through the **qos log lines**, **qos log level**, and **debug qos** commands. The log display can also be output to the console through the **qos log console** command or sent to the policy software in the switch (which manages policies downloaded from an LDAP server) through the **qos forward log** command.

Clearing the QoS Log

The QoS log can get large if invalid rules are configured on the switch, or if a lot of QoS events have taken place. Clearing the log makes the file easier to manage.

To clear the QoS log, use the **clear qos log** command. For example:

```
-> clear qos log
```

All the current lines in the QoS log are deleted.

Setting the Statistics Interval

To change how often the switch polls the network interfaces for QoS statistics, use the **qos stats interval** command with the desired interval time in seconds. The default is 60 seconds. For example:

```
-> qos stats interval 30
```

Statistics are displayed through the **show qos statistics** command. For more information about this command, see the *OmniSwitch AOS Release 8 CLI Reference Guide*.

Returning the Global Configuration to Defaults

To return the global QoS configuration to its default settings, use the **qos reset** command. The defaults then become active on the switch. For a list of global defaults, see “QoS Defaults” on page 27-26.

Note. The **qos reset** command only affects the global configuration. It does not affect any policy configuration.

Verifying Global Settings

To display information about the global configuration, use the following **show** commands:

show qos config	Displays global information about the QoS configuration.
show qos statistics	Displays statistics about QoS events.

For more information about the syntax and displays of these commands, see the *OmniSwitch AOS Release 8 CLI Reference Guide*.

Creating Policies

This section describes how to create policies in general. For information about configuring specific types of policies, see [“Policy Applications” on page 27-66](#).

Basic commands for creating policies are as follows:

- policy condition**
- policy action**
- policy rule**

This section describes generally how to use these commands. For additional details about command syntax, see the *OmniSwitch AOS Release 8 CLI Reference Guide*.

Note. A policy rule can include a policy condition or a policy action that was created through PolicyView rather than the CLI. But a policy rule, policy action, or policy condition can only be modified through the source that created it. For example, if an action was created in PolicyView, it can be included in a policy rule configured through the CLI, but it cannot be modified through the CLI.

Policies are not used to classify traffic until the **qos apply** command is entered. See [“Applying the Configuration” on page 27-63](#).

Quick Steps for Creating Policies

Follow the steps below for a quick tutorial on creating policies. More information about how to configure each command is given in later sections of this chapter.

- 1 Create a policy condition with the **policy condition** command. For example:

```
-> policy condition cond3 source ip 10.10.2.3
```

- 2 Create a policy action with the **policy action** command. For example:

```
-> policy action action2 priority 7
```

- 3 Create a policy rule with the **policy rule** command. For example:

```
-> policy rule my_rule condition cond3 action action2
```

- 4 Use the **qos apply** command to apply the policy to the configuration. For example:

```
-> qos apply
```

Note. (Optional) To verify that the rule has been configured, use the **show policy rule** command. The display is similar to the following:

```
-> show policy rule
Rule name           : my_rule
Condition name      = cond3,
Action name         = action2,
```

An example of how the example configuration commands might display when entered sequentially on the command line is given here:

```
-> policy condition cond3 source ip 10.10.2.3
-> policy action action2 priority 7
-> policy rule my_rule condition cond3 action action2
-> qos apply
```

ASCII-File-Only Syntax

When the **policy rule**, **policy condition**, and **policy action** commands as well as any of the condition group commands are configured and saved in an ASCII file (typically through the **snapshot** command), the commands included in the file include syntax indicating the origin of the command. The origin specifies where the rule, condition, condition group, or action was created, either an LDAP server or the CLI (**from ldap** or **from cli**). For built-in QoS objects, the syntax displays as **from blt**. For example:

```
-> policy action A2 from ldap disposition accept
```

The **from** option is configurable (for LDAP or CLI only) on the command line; however, it is not recommended that origin of a QoS object be modified. The **blt** keyword indicates built-in; this keyword cannot be used on the command line. For information about built-in policies and QoS groups, see [“How Policies Are Used” on page 27-21](#).

Creating Policy Conditions

This section describes how to create policy conditions in general. Creating policy conditions for particular types of network situations is described later in this chapter.

Note. Policy condition configuration is not active until the **qos apply** command is entered. See [“Applying the Configuration” on page 27-63](#).

To create or modify a policy condition, use the **policy condition** command with the keyword for the type of traffic you want to classify, for example, an IP address or group of IP addresses. In this example, a condition (**c3**) is created for classifying traffic from source IP address 10.10.2.1:

```
-> policy condition c3 source ip 10.10.2.1
```

There are many options for configuring a condition, depending on how you want the switch to classify traffic for this policy. An overview of the options is given here. Later sections of this chapter describe how to use the options in particular network situations.

Note. The group options in this command refer to groups of addresses, services, or ports that you configure separately through policy group commands. Rather than create a separate condition for each address, service, or port, use groups and attach the group to a single condition. See [“Using Condition Groups in Policies” on page 27-45](#) for more information about setting up groups.

More than one condition parameter can be specified. Some condition parameters are mutually exclusive. For supported combinations of condition parameters, see [“Policy Conditions” on page 27-23](#).

policy condition keywords

source ip	service	source port
source ipv6	service group	source port group
destination ip	ip protocol	destination port
destination ipv6	icmptype	destination port group
source network group	icmpcode	
destination network group	802.1p	ipv6
source ip port	inner 802.1p	nh
destination ip port	tos	flow-label
source tcp port	dscp	app-mon-application-group
destination tcp port		app-mon-application-name
source udp port	source mac	
destination udp port	destination mac	
established	source mac group	
tcpflags	destination mac group	
	source vlan	
	source vlan group	
	inner source vlan	
	inner source vlan group	
	destination vlan (multicast only)	
	ethertype	

The condition is not activated on the switch until you enter the **qos apply** command.

Removing Condition Parameters

To remove a classification parameter from the condition, use **no** with the relevant keyword. For example:

```
-> policy condition c3 no source ip
```

The specified parameter (in this case, a source IP address) is removed from the condition (**c3**) at the next **qos apply**.

Note. You cannot remove all parameters from a policy condition. A condition must be configured with at least one parameter.

Deleting Policy Conditions

To remove a policy condition, use the **no** form of the command. For example:

```
-> no policy condition c3
```

The condition (**c3**) cannot be deleted if it is currently being used by a policy rule. If a rule is using the condition, the switch displays an error message. For example:

```
ERROR: c3 is being used by rule 'my_rule'
```

In this case, the condition is not deleted. The condition (**c3**) must first be removed from the policy rule (**my_rule**). See [“Creating Policy Rules” on page 27-39](#) for more information about setting up rules.

If **c3** is not used by a policy rule, it is deleted after the next **qos apply**.

Creating Policy Actions

This section describes how to configure policy actions in general. Creating policy actions for particular types of network situations is described later in this chapter.

To create or modify a policy action, use the **policy action** command with the desired action parameter. A policy action must specify the way traffic must be treated. For example, it might specify a priority for the flow, a source address to rewrite in the IP header, or it can specify that the flow is dropped. For example:

```
-> policy action Block disposition drop
```

In this example, the action (**Block**) has a disposition of **drop** (disposition determines whether a flow is allowed or dropped on the switch). This action can be used in a policy rule to deny a particular type of traffic specified by a policy condition.

Note. Policy action configuration is not active until the **qos apply** command is entered. See [“Applying the Configuration” on page 27-63](#).

More than one action parameter can be specified. Some parameters are mutually exclusive. In addition, some action parameters are only supported with particular condition parameters. For information about supported combinations of condition and action parameters, see [“Policy Conditions” on page 27-23](#) and [“Policy Actions” on page 27-24](#). See the *OmniSwitch AOS Release 8 CLI Reference Guide* for details about command syntax.

policy action keywords

disposition	dcsp
shared	map
priority	port-disable
maximum bandwidth	redirect port
maximum depth	redirect linkagg
cir cbs pir pbs	no-cache
tos	mirror
802.1p	

Note. If you combine **priority** with **802.1p**, **dscp**, **tos**, or **map**, in an action, the priority value is used to prioritize the flow.

Removing Action Parameters

To remove an action parameter or return the parameter to its default, use **no** with the relevant keyword.

```
-> policy action a6 no priority
```

This example removes the configured priority value from action **a6**. If any policy rule is using action **a6**, the default action is to allow the flow classified by the policy condition.

The specified parameter (in this case, priority) is removed from the action at the next **qos apply**.

Deleting a Policy Action

To remove a policy action, use the **no** form of the command.

```
-> no policy action a6
```

The action cannot be deleted if it is currently being used by a policy rule. If a rule is using the action, the switch displays an error message. For example:

```
ERROR: a6 is being used by rule 'my_rule'
```

In this case, the action is not deleted. The action (**a6**) must first be removed from the policy rule (**my_rule**). See [“Creating Policy Rules” on page 27-39](#) for more information about setting up rules.

If **a6** is not used by a policy rule, it is deleted after the next **qos apply**.

Creating Policy Rules

This section describes in general how to create or delete policy rules and rule parameters. See later sections of this chapter for more information about creating particular types of policy rules.

To create a policy rule, use the **policy rule** command and specify the name of the rule, the desired condition, and the desired action.

In this example, condition **c3** is created for traffic coming from IP address 10.10.8.9, and action **a7** is created to prioritize the flow. Policy rule **rule5** combines the condition and the action, so that traffic arriving on the switch from 10.10.8.9 is placed into the highest priority queue.

```
-> policy condition c3 source ip 10.10.8.9
-> policy action a7 priority 7
-> policy rule rule5 condition c3 action a7
```

The rule (**rule5**) only takes effect after the **qos apply** command is entered. For more information about the **qos apply** command, see [“Applying the Configuration” on page 27-63](#).

The **policy rule** command can specify the following keywords:

policy rule keywords

precedence
validity period
save
log
log interval
count
trap

In addition, a policy rule can be administratively disabled or re-enabled using the **policy rule** command. By default rules are enabled. For a list of rule defaults, see [“Policy Rule Defaults” on page 27-28](#).

Information about using the **policy rule** command options is given in the next sections.

Configuring a Rule Validity Period

A validity period specifies the days and times during which a rule is in effect. By default there is no validity period associated with a rule, which means the rule is always active.

To configure the days, months, times, and/or time intervals during which a rule is active, use the **policy validity-period** command. Once the validity period is defined, it is then associated with a rule using the **policy rule** command. For example, the following commands create a validity period named **vp01** and associate it with rule **r01**:

```
-> policy validity period vp01 hours 13:00 to 19:00 days monday friday
-> policy rule r01 validity period vp01
```

Note the following when using validity periods to restrict the times when a rule is active:

- Only one validity period is associated with a policy rule. Each time this command is entered with a validity period name specified, the existing period name is overwritten with the new one.
- A rule is only in effect when all the parameters of its validity period are true. In the above example, rule **r01** is only applied between 13:00 and 19:00 on Mondays and Fridays. During all other times and days, the rule is not applied.
- Software and hardware resources are allocated for rules associated with a validity period even if the validity period is not active. Pre-allocating the resources makes sure the rule can be enforced when the validity period becomes active.

Disabling Rules

By default, rules are enabled. Rules are disabled or re-enabled through the **policy rule** command using the **disable** and **enable** options. For example:

```
-> policy rule rule5 disable
```

This command prevents **rule5** from being used to classify traffic.

Note. If **qos disable** is entered, the rule is not used to classify traffic even if the rule is enabled. For more information about enabling/disabling QoS globally, see [“Enabling/Disabling QoS” on page 27-31](#).

Rule Precedence

The switch attempts to classify flows coming into the switch according to policy precedence. Only the rule with the highest precedence is applied to the flow. This is true even if the flow matches more than one rule.

Precedence is particularly important for Access Control Lists (ACLs). For more details about precedence and examples for using precedence, see [Chapter 27, “Configuring QoS.”](#)

How Precedence is Determined

When there is a conflict between rules, precedence is determined using one of the following methods:

- **Precedence value**—Each policy has a precedence value. The value is user-configured through the **policy rule** command in the range from 0 (lowest) to 65535 (highest). (The range 30000 to 65535 is typically reserved for PolicyView.) By default, a policy rule has a precedence of 0.
- **Configured rule order**—If a flow matches more than one rule and both rules have the same precedence value, the rule that was *configured first* in the list takes precedence.

Specifying Precedence for a Particular Rule

To specify a precedence value for a particular rule, use the **policy rule** command with the precedence keyword. For example:

```
-> policy rule r1 precedence 200 condition c1 action a1
```

Saving Rules

The **save** option marks the policy rule so that the rule is captured in an ASCII text file (using the **configuration snapshot** command) and saved to the working directory (using the **issu slot** command). By default, rules are saved.

If the **save** option is removed from a rule, the **qos apply** command activates the rule for the current session, but the rule is not saved over a reboot. Typically, the **no save** option is used for temporary policies that you do not want saved in the switch configuration file.

To remove the **save** option from a policy rule, use **no** with the **save** keyword. For example:

```
-> policy rule rule5 no save
```

To reconfigure the rule as saved, use the **policy rule** command with the **save** option. For example:

```
-> policy rule rule5 save
```

For more information about the **configuration snapshot**, **write memory**, and **copy running-config working** commands, see the *OmniSwitch AOS Release 8 Switch Management Guide* and the *OmniSwitch AOS Release 8 CLI Reference Guide*.

For more information about applying rules, see [“Applying the Configuration” on page 27-63](#).

Logging Rules

Logging a rule is useful for determining the source of firewall attacks. To specify that the switch must log information about flows that match the specified policy rule, use the **policy rule** command with the **log** option. For example:

```
-> policy rule rule5 log
```

To stop the switch from logging information about flows that match a particular rule, use **no** with the **log** keyword. For example:

```
-> policy rule rule5 no log
```

When logging is active for a policy rule, a logging interval is applied to specify how often to look for flows that match the policy rule. By default, the interval time is set to 30 seconds. To change the log interval time, use the optional **interval** keyword with the log option. For example:

```
-> policy rule rule5 log interval 1500
```

Note that setting the log interval time to 0 specifies to log as often as possible.

Deleting Rules

To remove a policy rule, use the **no** form of the command.

```
-> no policy rule rule1
```

The rule is deleted after the next **qos apply**.

Creating Policy Lists

A QoS policy list provides a method for grouping multiple policy rules together and applying the group of rules to specific types of traffic. The type of traffic to which a policy list is applied is determined by the type of list that is configured. There are two types of policy lists:

- **Default**—This list is always available on every switch and is not configurable. By default, a policy rule is associated with this list when the rule is created. All default list rules are applied to ingress traffic.
- **Universal Network Profile (UNP)**—This type of configurable policy list is associated with a Universal Network Profile (UNP). The rules in this list are applied to ingress traffic that is classified by the UNP. See [Chapter 30, “Configuring Universal Network Profiles,”](#) for more information.

To create a UNP policy list, use the **policy list** command to specify a list name and then use the **policy list rules** command to specify the names of one or more existing QoS policy rules to add to the list. For example, the following commands create two policy rules and associates these rules with the **unpl_rules** list:

```
-> policy condition c1 802.1p 5
-> policy action a1 disposition drop
-> policy rule r1 condition c1 action a1 no default-list
-> policy condition c2 source ip 10.5.5.0
-> policy action a2 disposition accept
-> policy rule r2 condition c2 action a2 no default-list
-> policy list unpl_rules type unip enable
-> policy list unpl_rules rules r1 r2
-> qos apply
```

Note that the **no default-list** option was used to create the rules. Using this option is recommended when creating a policy list for a UNP. See [“Guidelines for Configuring Policy Lists”](#) on page 27-43.

The following example creates a policy rule (**rule1**) that is automatically assigned to the default policy list.

```
-> policy condition cond1 source mac 00:11:22:33:44:55 source vlan 100
-> policy action act1 disposition drop
-> policy rule rule1 condition cond1 action act1
-> qos apply
```

In this example, the **no default-list** parameter is *not* used with the **policy rule** command, so the rule is automatically assigned to the default policy list. The default list always exists and is not configurable. As a result, the **policy list** command is not required to assign the rule to the default list.

By default, a policy list is enabled at the time the list is created. To disable or enable a policy list, use the following commands:

```
-> policy list unpl_rules disable
-> policy list unpl_rules enable
```

To remove an individual rule from a UNP policy list, use the following command:

```
-> policy list unpl_rules no rules r2
```

To remove an entire UNP policy list from the switch configuration, use the following command:

```
-> no policy list unpl_rules
```

Use the **show policy list** command to display the QoS policy rule configuration for the switch.

Guidelines for Configuring Policy Lists

Consider the following guidelines when configuring QoS policy rules and lists:

- Create policy rules first before attempting to create a list. The **policy list rules** command requires that the specified policy rules must already exist in the switch configuration. See “[Creating Policies](#)” on [page 27-35](#).
- A rule can belong to the default list and a Universal Network Profile (UNP) list at the same time. In addition, a rule can also belong to multiple UNP lists. Each time a rule is assigned to a policy list, however, an instance of that rule is created. Each instance is allocated system resources.
- By default, QoS assigns rules to the default policy list. To exclude a rule from this list, use the **no default-list** option of the **policy rule** command when the rule is created. See “[Using the Default Policy List](#)” on [page 27-43](#) for more information.
- If the rule is going to belong to a QoS policy list for a UNP, use the **no default-list** option when creating the rule. Doing so will give the rule precedence over default list rules when the policy list is applied to UNP device traffic.
- Only one policy list per UNP is allowed, but a single policy list can be associated with multiple profiles. See [Chapter 30, “Configuring Universal Network Profiles,”](#) for more information.
- Up to 32 policy lists (including the default list) are supported per switch.
- If a rule is a member of multiple policy lists but one or more of these lists are disabled, the rule is still active for those lists that are enabled.
- If the QoS status of an individual rule is disabled, then the rule is disabled for all policy lists, even if a list to which the policy belongs is enabled.
- Policy lists are not active on the switch until the **qos apply** command is issued.

Using the Default Policy List

A default policy list always exists in the switch configuration. By default, a policy rule is added to this list at the time the rule is created. A rule remains a member of the default list even when it is subsequently assigned to additional lists.

Each time a rule is assigned to a list, an instance of that rule is created and allocated system resources. As a result, rules that belong to multiple lists create multiple instances of the same rule. One way to conserve resources is to remove a rule from the default policy list.

To exclude a rule from the default policy list, use the **no default-list** option of the **policy rule** command when the rule is created. For example:

```
-> policy rule r1 condition c1 action a1 no default-list
```

The **no default-list** option can also remove an existing rule from the default list. For example, the **r2** rule already exists in the switch configuration but was not excluded from the default list at the time the rule was created. The following command removes the rule from the default list:

```
-> policy rule r2 condition c1 action a1 no default-list
```

To add an existing rule to the default list, use the **default-list** parameter option of the policy rule command. For example:

```
-> policy rule r2 condition c1 action a1 default-list
```

Rules associated with the default policy list are applied only to ingress traffic, unless the rule is also assigned to an egress policy list.

Verifying Policy Configuration

To view information about policy rules, conditions, and actions configured on the switch, use the following commands:

show policy condition	Displays information about all pending and applied policy conditions or a particular policy condition configured on the switch. Use the applied keyword to display information about applied conditions only.
show policy action	Displays information about all pending and applied policy actions or a particular policy action configured on the switch. Use the applied keyword to display information about applied actions only.
show policy rule	Displays information about all pending and applied policy rules or a particular policy rule. Use the applied keyword to display information about applied rules only.
show active policy rule	Displays applied policy rules that are active (enabled) on the switch.

Using Condition Groups in Policies

Condition groups are made up of multiple IPv4 addresses, MAC addresses, services, ports, or VLANs to which you want to apply the same action or policy rule. Instead of creating a separate condition for each address, etc., create a condition group and associate the group with a condition. Groups are especially useful when configuring filters, or Access Control Lists (ACLs); they reduce the number of conditions and rules that must be entered. For information about setting up ACLs, see [Chapter 27, “Configuring QoS.”](#)

Commands used for configuring condition groups include the following:

```

policy network group
policy service group
policy mac group
policy port group

```

Access Control Lists (ACLs) typically use condition groups in policy conditions to reduce the number of rules required to filter particular types of traffic. For more information about ACLs, see [“Using Access Control Lists” on page 27-55.](#)

Sample Group Configuration

1 Create the group and group entries. In this example, a network group is created:

```
-> policy network group netgroup1 10.10.5.1 10.10.5.2
```

2 Attach the group to a policy condition. For more information about configuring conditions, see [“Creating Policy Conditions” on page 27-36.](#)

```
-> policy condition cond3 source network group netgroup1
```

Note. (Optional) Use the **show policy network group** command to display information about the network group. Each type of condition group has a corresponding show command. For example:

```

-> show policy network group
Group Name:          From  Entries
Switch              blt   4.0.1.166
                   10.0.1.166

+netgroup1          cli   10.10.5.1/255.255.255.0
                   10.10.5.2/255/255/255.0

```

Note. See the *OmniSwitch AOS Release 8 CLI Reference Guide* for more information about the output of this display. See [“Verifying Condition Group Configuration” on page 27-51](#) for more information about using **show** commands to display information about condition groups.

3 Attach the condition to a policy rule. (For more information about configuring rules, see [“Creating Policy Rules” on page 27-39.](#)) In this example, action **act4** has already been configured. For example:

```
-> policy rule my_rule condition cond3 action act4
```

4 Apply the configuration. See [“Applying the Configuration” on page 27-63](#) for more information about this command.

```
-> qos apply
```

Creating Network Groups

Use network policy groups for policies based on IPv4 source or destination addresses. Note that IPv6 addresses are not supported with network groups at this time. The policy condition specifies whether the network group is a source network group, destination network group, or multicast network group.

- **Default switch group**—Note that by default the switch contains a network group called **switch** that includes all IPv4 addresses configured for the switch itself. This network group can also be used in policy conditions.
- **ACLs**—Typically network groups are used for Access Control Lists. For more information about ACLs, see [“Using Access Control Lists” on page 27-55](#).

To create a network policy group, use the **policy network group** command. Specify the name of the group and the IPv4 address(es) to be included in the group. Each IPv4 address must be separated by a space. A mask can also be specified for an address. If a mask is not specified, the address is assumed to be a host address.

Note. Network group configuration is not active until the **qos apply** command is entered.

In this example, a policy network group called **netgroup2** is created with two IPv4 addresses. No mask is specified, so the IPv4 addresses are assumed to be host addresses.

```
-> policy network group netgroup2 10.10.5.1 10.10.5.2
```

In the next example, a policy network group called **netgroup3** is created with two IPv4 addresses. The first address also specifies a mask.

```
-> policy network group netgroup3 173.21.4.39 mask 255.255.255.0 10.10.5.3
```

In this example, the 173.201.4.39 address is sub-netted, so that any address in the subnet is included in the network group. For the second address, 10.10.5.3, a mask is not specified; the address is assumed to be a host address.

The network group can then be associated with a condition through the **policy condition** command. The network group must be specified as a **source network group** or **destination network group**. In this example, **netgroup3** is configured for condition **c4** as source network group:

```
-> policy condition c4 source network group netgroup3
```

To remove addresses from a network group, use **no** and the relevant address(es). For example:

```
-> policy network group netgroup3 no 173.21.4.39
```

This command deletes the 173.21.4.39 address from **netgroup3** after the next **qos apply**.

To remove a network group from the configuration, use the **no** form of the **policy network group** command with the relevant network group name. The network group must not be associated with any policy condition or action. For example:

```
-> no policy network group netgroup3
```

If the network group is not currently associated with any condition or action, the network group **netgroup3** is deleted from the configuration after the next **qos apply**.

If a condition or an action is using **netgroup3**, the switch displays an error message similar to the following:

```
ERROR: netgroup3 is being used by condition 'c4'
```

In this case, remove the network group from the condition first, then enter the **no** form of the **policy network group** command. For example:

```
-> policy condition c4 no source network group
-> no policy network group netgroup3
```

The **policy condition** command removes the network group from the condition. (See “[Creating Policy Conditions](#)” on page 27-36 for more information about configuring policy conditions.) The network group is deleted at the next **qos apply**.

Creating Services

Policy services are made up of TCP or UDP ports or port ranges. They include source or destination ports, or both, but the ports must be the same type (TCP *or* UDP). Mixed port types cannot be included in the same service.

Policy services can be associated with policy service groups, which are then associated with policy conditions; or they can be directly associated with policy conditions.

To create a service, use the **policy service** command. With this command, there are two different methods for configuring a service. You can specify the protocol and the IP port; or you can use shortcut keywords. The following table lists the keyword combinations:

Procedure	Keywords	Notes
Basic procedure for either TCP or UDP service	protocol source ip port destination ip port	<i>The protocol must be specified with at least one source or destination port.</i>
Shortcut for TCP service	source tcp port destination tcp port	<i>Keywords can be used in combination.</i>
Shortcut for UDP service	source udp port destination udp port	<i>Keywords can be used in combination.</i>

An IP protocol (TCP or UDP), source IP port and/or destination IP port (or port range) must be associated with a service. IP port numbers are well-known port numbers defined by the IANA. For example, port numbers for FTP are 20 and 21; Telnet is 23.

In this example, a policy service called **telnet1** is created with the TCP protocol number (**6**) and the well-known Telnet destination port number (**23**).

```
-> policy service telnet1 protocol 6 destination ip port 23
```

A shortcut for this command replaces the **protocol** and **destination ip port** keywords with **destination tcp port**:

```
-> policy service telnet1 destination tcp port 23
```

In the next example, a policy service called **ftp2** is created with port numbers for FTP (20 and 21):

```
-> policy service ftp2 protocol 6 source ip port 20-21 destination ip port 20
```

A shortcut for this command replaces the **protocol**, **source ip port**, and **destination ip port** keywords with **source tcp port** and **destination tcp port**:

```
-> policy service ftp2 source tcp port 20-21 destination tcp port 20
```

Multiple services created through the **policy service** command can be associated with a policy service group; or, individual services can be configured for a policy condition. If you have multiple services to associate with a condition, configure a service group and attach it to a condition. Service groups are described in [“Creating Service Groups” on page 27-48](#).

Note. Service configuration is not active until the **qos apply** command is entered.

To remove a policy service, enter the **no** form of the command.

```
-> no policy service ftp2
```

The **ftp2** service is deleted from the configuration at the next **qos apply** if the service is not currently associated with a policy condition or a service group.

Creating Service Groups

Service groups are made up of policy services. First configure the policy service, then create the service group which includes the policy service(s).

Use the **policy service group** command. For example:

```
-> policy service group serv_group telnet1 ftp2
```

In this example, a policy service group called **serv_group** is created with two policy services (**telnet1** and **ftp2**). The policy services were created with the **policy service** command. (See [“Creating Services” on page 27-47](#) for information about configuring policy services.)

Note. The policy service group can include only services with all source ports, all destination ports, or all source and destination ports. For example, the group cannot include a service that specifies a source port and another service that specifies a destination port.

The service group can then be associated with a condition through the **policy condition** command. For example:

```
-> policy condition c6 service group serv_group
```

This command configures a condition called **c6** with service group **serv_group**. All of the services specified in the service group are included in the condition. (For more information about configuring conditions, see [“Creating Policy Conditions” on page 27-36](#).)

Note. Service group configuration must be specifically applied to the configuration with the **qos apply** command.

To delete a service from the service group, use **no** with the relevant service name. For example:

```
-> policy service group serv_group no telnet1
```

In this example, the service **telnet1** is removed from policy service group **serv_group**.

To delete a service group from the configuration, use the **no** form of the **policy service group** command. The service group must not be associated with any condition. For example:

```
-> no policy service group serv_group
```

Service group **serv_group** is deleted at the next **qos apply**. If **serv_group** is associated with a policy condition, an error message displays instead. For example:

```
ERROR: serv_group is being used by condition 'c6'
```

In this case, remove the service group from the condition first; then enter the **no policy service group** command. For example:

```
-> policy condition c6 no service group
-> no policy service group serv_group
```

The **policy condition** command removes the service group from the policy condition. (See [“Creating Policy Conditions” on page 27-36](#) for more information about configuring policy conditions.) The service group is deleted at the next **qos apply**.

Creating MAC Groups

MAC groups are made up of multiple MAC addresses that you want to attach to a condition.

To create a MAC group, use the **policy mac group** command.

For example:

```
-> policy mac group macgrp2 08:00:20:00:00:00 mask ff:ff:ff:00:00:00
00:20:DA:05:f6:23
```

This command creates MAC group **macgrp2** with two MAC addresses. The first address includes a MAC address mask, so that any MAC address starting with 08:00:20 is included in **macgrp2**.

The MAC group can then be associated with a condition through the **policy condition** command. Note that the policy condition specifies whether the group must be used for *source* or *destination*. For example:

```
-> policy condition cond3 source mac group macgrp2
```

This command creates a condition called **cond3** that can be used in a policy rule to classify traffic by source MAC addresses. The MAC addresses are specified in the MAC group. For more information about configuring conditions, see [“Creating Policy Conditions” on page 27-36](#).

Note. MAC group configuration is not active until the **qos apply** command is entered.

To delete addresses from a MAC group, use **no** and the relevant address(es):

```
-> policy mac group macgrp2 no 08:00:20:00:00:00
```

This command specifies that MAC address 08:00:20:00:00:00 is deleted from **macgrp2** at the next **qos apply**.

To delete a MAC group, use the **no** form of the **policy mac group** command with the relevant MAC group name. The group must not be associated with any policy condition. For example:

```
-> no policy mac group macgrp2
```

MAC group **macgrp2** is deleted at the next **qos apply**. If **macgrp2** is associated with a policy condition, an error message displays instead:

```
ERROR: macgrp2 is being used by condition 'cond3'
```

In this case, remove the MAC group from the condition first; then enter the **no policy mac group** command. For example:

```
-> policy condition cond3 no source mac group
-> no policy mac group macgrp2
```

The **policy condition** command removes the MAC group from the condition. See [“Creating Policy Conditions” on page 27-36](#) for more information about configuring policy conditions. The MAC group is deleted at the next **qos apply**.

Creating Port Groups

Port groups are made up of slot and port number combinations. Note that there are many built-in port groups, one for each slot on the switch. Built-in port groups are subdivided by slice. The built-in groups are named by slot (**Slot01**, **Slot02**, etc.). To view the built-in groups, use the **show policy port group** command.

To create a port group, use the **policy port group** command. For example:

```
-> policy port group techpubs 1/2/1 1/3/1 1/3/2 1/3/3
```

The port group can then be associated with a condition through the **policy condition** command. Note that the policy condition specifies whether the group must be used for *source* or *destination*. For example:

```
-> policy condition cond4 source port group techpubs
```

This command creates a condition called **cond4** that can be used in a policy rule to classify traffic by source port number. The port numbers are specified in the port group. For more information about configuring conditions, see [“Creating Policy Conditions” on page 27-36](#).

Note. Port group configuration is not active until the **qos apply** command is entered.

To delete ports from a port group, use **no** and the relevant port number.

```
-> policy port group techpubs no 1/2/1
```

This command specifies that port 2/1 is deleted from the **techpubs** port group at the next **qos apply**.

To delete a port group, use the **no** form of the **policy port group** command with the relevant port group name. The port group must not be associated with any policy condition. For example:

```
-> no policy port group techpubs
```

The port group **techpubs** are deleted at the next **qos apply**. If **techpubs** is associated with a policy condition, an error message displays instead:

```
ERROR: techpubs is being used by condition 'cond4'
```

In this case, remove the port group from the condition first; then enter the **no policy port group** command. For example:

```
-> policy condition cond4 no source port group
-> no policy port group techpubs
```

The **policy condition** command removes the port group from the policy condition. (See “[Creating Policy Conditions](#)” on page 27-36 for more information about configuring policy conditions.) The port group is deleted at the next **qos apply**.

Verifying Condition Group Configuration

To display information about condition groups, use the following **show** commands:

show policy network group	Displays information about all pending and applied policy network groups or a particular network group. Use the applied keyword to display information about applied groups only.
show policy service	Displays information about all pending and applied policy services or a particular policy service configured on the switch. Use the applied keyword to display information about applied services only.
show policy service group	Displays information about all pending and applied policy service groups or a particular service group. Use the applied keyword to display information about applied groups only.
show policy mac group	Displays information about all pending and applied MAC groups or a particular policy MAC group configured on the switch. Use the applied keyword to display information about applied groups only.
show policy port group	Displays information about all pending and applied policy port groups or a particular port group. Use the applied keyword to display information about applied groups only.

See the *OmniSwitch AOS Release 8 CLI Reference Guide* for more information about the syntax and output for these commands.

Using Map Groups

Map groups are used to map 802.1p, ToS, or DSCP values to different values. The following mapping scenarios are supported:

- 802.1p to 802.1p, based on Layer 2, Layer 3, and Layer 4 parameters and source/destination chassis/slot/port. In addition, 802.1p classification can trigger this action.
- ToS or DSCP to 802.1p, based on Layer 3 and Layer 4 parameters and source/destination chassis/slot/port. In addition ToS or DSCP classification can trigger this action.

Note. Map groups are associated with a policy *action*.

Commands used for creating map groups include the following:

policy map group
policy action map

Sample Map Group Configuration

1 Create the map group with mapping values. For detailed information about map groups and how to set them up, see [“How Map Groups Work” on page 27-53](#) and [“Creating Map Groups” on page 27-53](#).

```
-> policy map group tosGroup 1-2:5 4:5 5-6:7
```

2 Attach the map group to a policy action. See [“Creating Policy Actions” on page 27-38](#) for more information about creating policy actions.

```
-> policy action tosMap map tos to 802.1p using tosGroup
```

Note. (Optional) Use the **show policy map group** command to verify the map group.

```
-> show policy map group
Group Name          From  Entries
+tosGroup           cli  1-2:5
                   4:5
                   5-6:7
```

Note. For more information about this command, see [“Verifying Map Group Configuration” on page 27-54](#) and the *OmniSwitch AOS Release 8 CLI Reference Guide*.

3 Attach the action to a policy rule. In this example, the condition **Traffic** is already configured. For more information about configuring rules, see [“Creating Policy Rules” on page 27-39](#).

```
-> policy rule r3 condition Traffic action tosMap
```

4 Apply the configuration. For more information about this command, see [“Applying the Configuration” on page 27-63](#).

```
-> qos apply
```

How Map Groups Work

When mapping from 802.1p to 802.1p, the action results in remapping the specified values. Any values that are not specified in the map group are preserved. In this example, a map group is created for 802.1p bits.

```
-> policy map group Group2 1-2:5 4:5 5-6:7
-> policy action Map1 map 802.1p to 802.1p using Group2
```

The *to* and *from* values are separated by a colon (:). If traffic with 802.1p bits comes into the switch and matches a policy that specifies the **Map1** action, the bits are remapped according to **Group2**. If the incoming 802.1p value is 1 or 2, the value is mapped to 5. If the incoming 802.1p value is 3, the outgoing value is 3 (the map group does not specify any mapping for a value of 3). If the incoming 802.1p value is 4, the value is mapped to 5. If the incoming 802.1p value is 5 or 6, the value is mapped to 7.

When mapping to a different type of value, however (ToS/DSCP to 802.1p), any values in the incoming flow that matches the rule but that are not included in the map group is zeroed out. For example, the following action specifies the same map group but instead specifies mapping 802.1p to ToS:

```
-> policy action Map2 map tos to 802.1p using Group2
```

In this case, if ToS traffic comes into the switch and matches a policy that specifies the **Map2** action, the ToS value is mapped according to **Group2** if the value is specified in **Group2**. If the incoming ToS value is 2, the value is mapped to 5; however, if the incoming value is 3, the switch maps the value to zero because there is no mapping in **Group2** for a value of 3.

Note. Ports on which the flow is mapped must be a trusted port; otherwise the flow is dropped.

Creating Map Groups

To create a map group, use the **policy action map** command. For example, to create a map group called **tosGroup**, enter:

```
-> policy map group tosGroup 1-2:5 4:5 5-6:7
```

The *to* and *from* values are separated by a colon (:). For example, a value of 2 is mapped to 5.

Note. Map group configuration is not active until the **qos apply** command is entered.

The remapping group can then be associated with a rule through the **policy action** command. In this example, a policy condition called **Traffic** has already been configured.

```
-> policy action tosMap map tos to 802.1p using tosGroup
-> policy rule r3 condition Traffic action tosMap
```

To delete mapping values from a group, use **no** and the relevant values:

```
-> policy map group tosGroup no 1-2:4
```

The specified values are deleted from the map group at the next **qos apply**.

To delete a map group, use the **no** form of the **policy map group** command. The map group must not be associated with a policy action. For example:

```
-> no policy map group tosGroup
```

If **tosGroup** is currently associated with an action, an error message similar to the following displays:

```
ERROR: tosGroup is being used by action 'tosMap'
```

In this case, remove the map group from the action, then enter the **no policy map group** command:

```
-> policy action tosMap no map group  
-> no policy map group tosGroup
```

The map group is deleted at the next **qos apply**.

Note. For Layer 2 flows, you cannot have more than one action that maps DSCP.

Verifying Map Group Configuration

To display information about all map groups, including all pending and applied map groups, use the **show policy map group** command. To display only information about applied map groups, use the **applied** keyword with the command. For more information about the output of this command, see the *OmniSwitch AOS Release 8 CLI Reference Guide*.

Using Access Control Lists

Access Control Lists (ACLs) are QoS policies used to control whether or not packet flows are allowed or denied at the switch or router interface. ACLs are sometimes referred to as filtering lists.

ACLs are distinguished by the kind of traffic they filter. In a QoS policy rule, the type of traffic is specified in the policy condition. The policy action determines whether the traffic is allowed or denied. For detailed descriptions about configuring policy rules, see “[QoS Policy Overview](#)” on page 27-21 and “[Creating Policies](#)” on page 27-35.

In general, the types of ACLs include:

- *Layer 2 ACLs*—for filtering traffic at the MAC layer. Usually uses MAC addresses or MAC groups for filtering.
- *Layer 3/4 ACLs*—for filtering traffic at the network layer. Typically uses IP addresses or IP ports for filtering; note that IPX filtering is not supported.
- *Multicast ACLs*—for filtering IGMP traffic.
- *Security ACLs*—for improving network security. These ACLs utilize specific security features, such as **UserPorts** groups to prevent source IP address spoofing, ICMP drop rules and TCP connection rules.

Layer 2 ACLs

Layer 2 filtering filters traffic at the MAC layer. Layer 2 filtering can be done for both bridged and routed packets. As MAC addresses are learned on the switch, QoS classifies the traffic based on:

- MAC address or MAC group
- Source VLAN
- Physical chassis/slot/port or port group

The switch classifies the MAC address as both source *and* destination.

Layer 2 ACL: Example 1

In this example, the default bridged disposition is **accept** (the default). Since the default is **accept**, the **qos default bridged disposition** command would only need to be entered if the disposition had previously been set to **deny**. The command is shown here for completeness.

```
-> qos default bridged disposition accept
-> policy condition Address1 source mac 080020:112233 source vlan 5
-> policy action BlockTraffic disposition deny
-> policy rule FilterA condition Address1 action BlockTraffic
```

In this scenario, traffic with a source MAC address of 08:00:20:11:22:33 coming in on VLAN 5 would match condition **Address1**, which is a condition for a policy rule called **FilterA**. **FilterA** is then applied to the flow. Since **FilterA** has an action (**BlockTraffic**) that is set to deny traffic, the flow would be denied on the switch.

Note that although this example contains only Layer 2 conditions, it is possible to combine Layer 2 and Layer 3 conditions in the same policy.

Layer 2 ACL: Example 2

Maintaining the 802.1p Priority for IP Packets

When a tagged IP packet ingresses on a trusted port and the default classification priority for that port is set to DSCP (using the default DSCP value of 0), the DSCP value of the packet is mapped to the 802.1p value of the same packet. To avoid overwriting the 802.1p value in this scenario, configure an ACL as follows:

- 1 Create a port group to include all of the ports that QoS must trust.
- 2 Define policy conditions for the port group; one condition for each L2 priority (802.1p) value.
- 3 Define policy actions that stamp the IP traffic with the L2 priority value.
- 4 Define policy rules using the conditions and actions created in Steps 2 and 3.
- 5 Do not globally trust all switch ports.

For example:

```
-> policy port group VoIP 1/1/4-6 1/1/8 1/2/3-5
-> policy condition p0 destination port group VoIP
-> policy condition p1 destination port group VoIP
-> policy condition p2 destination port group VoIP
-> policy condition p3 destination port group VoIP
-> policy condition p4 destination port group VoIP
-> policy condition p5 destination port group VoIP
-> policy condition p6 destination port group VoIP
-> policy condition p7 destination port group VoIP
-> policy action p0 802.1p 0
-> policy action p1 802.1p 1
-> policy action p2 802.1p 2
-> policy action p3 802.1p 3
-> policy action p4 802.1p 4
-> policy action p5 802.1p 5
-> policy action p6 802.1p 6
-> policy action p7 802.1p 7
-> policy rule p0 condition p0 action p0
-> policy rule p1 condition p1 action p1
-> policy rule p2 condition p2 action p2
-> policy rule p3 condition p3 action p3
-> policy rule p4 condition p4 action p4
-> policy rule p5 condition p5 action p5
-> policy rule p6 condition p6 action p6
-> policy rule p7 condition p7 action p7
-> qos apply
```

Note. For pure Layer 2 packets, trusted ports retain the 802.1p value of the packet and queue the packets according to that priority value.

Layer 3 ACLs

The QoS software in the switch filters routed and bridged traffic at Layer 3.

For Layer 3 filtering, the QoS software in the switch classifies traffic based on:

- Source IP address or source network group
- Destination IP address or destination network group
- IP protocol
- ICMP code
- ICMP type
- Source TCP/UDP port
- Destination TCP/UDP port or service or service group

Layer 3 ACL: Example 1

In this example, the default routed disposition is **accept** (the default). Since the default is **accept**, the **qos default routed disposition** command would only need to be entered if the disposition had previously been set to **deny**. The command is shown here for completeness.

```
-> qos default routed disposition accept
-> policy condition addr2 source ip 192.68.82.0 source ip port 23 ip protocol 6
-> policy action Block disposition deny
-> policy rule FilterL31 condition addr2 action Block
```

Traffic with a source IP address of 192.68.82.0, a source IP port of 23, using protocol 6, matches condition **addr2**, which is part of **FilterL31**. The action for the filter (**Block**) is set to deny traffic. The flow is dropped on the switch.

Note that although this example contains only Layer 2 conditions, it is possible to combine Layer 2 and Layer 3 conditions in the same policy.

Layer 3 ACL: Example 2

This example uses condition groups to combine multiple IP addresses in a single condition. The default disposition is set to **deny**.

```
-> qos default routed disposition deny
-> policy network group GroupA 192.60.22.1 192.60.22.2 192.60.22.0
-> policy condition cond7 destination network group GroupA
-> policy action Ok disposition accept
-> policy rule FilterL32 condition cond7 action Ok
```

In this example, a network group, **GroupA**, is configured with three IP addresses. Condition **cond7** includes **GroupA** as a destination group. Flows coming into the switch destined for any of the specified IP addresses in the group matches rule **FilterL32**. **FilterL32** is configured with an action (**Ok**) to allow the traffic on the switch.

Note that although this example contains only Layer 2 conditions, it is possible to combine Layer 2 and Layer 3 conditions in the same policy.

IPv6 ACLs

An ACL is considered an IPv6 ACL if the **ipv6** keyword and/or any of the following specific policy condition keywords are used in the ACL to classify/filter IPv6 traffic:

IPv6 ACL Keywords

source ipv6	destination udp port
destination ipv6	ipv6
source tcp port	nh (next header)
destination port	flow-label
source udp port	

Note that IPv6 ACLs are effected only on IPv6 traffic. All other ACLs/policies with IP conditions that do not use the IPv6 keyword are effected only on IPv4 traffic. For example:

```
-> policy condition c1 tos 7
-> policy condition c2 tos 7 ipv6
```

In the above example, c1 is an IPv4 condition and c2 is an IPv6 condition. ACLs that use c1 are considered IPv4 policies; ACLs that use c2 are considered IPv6 policies. In addition, consider the following examples:

```
-> policy condition c3 source port 1/1/10
-> policy condition c4 source port 1/1/10 ipv6
```

Condition c3 applies to all traffic ingressing on port 1/10. However, condition c4 applies only to IPv6 traffic ingressing on port 1/10.

Note the following when configuring IPv6 ACLs:

- Trusted/untrusted behavior is the same for IPv6 traffic as it is for IPv4 traffic.
- IPv6 policies do not support the use of network groups, service groups, map groups, or MAC groups.
- IPv6 multicast policies are not supported.
- Anti-spoofing and other UserPorts profiles/filters do not support IPv6.
- The default (built-in) network group, “Switch”, only applies to IPv4 interfaces. There is no such group for IPv6 interfaces.

Multicast Filtering ACLs

Multicast filtering can be set up to filter clients requesting group membership through the Internet Group Management Protocol (IGMP). IGMP is used to track multicast group membership. The IP Multicast Switching (IPMS) function in the switch optimizes the delivery of IP multicast traffic by sending packets only to those stations that request it. Potential multicast group members can be filtered out so that IPMS does not send multicast packets to those stations.

For more information about IPMS, see [Chapter 26, “Configuring IP Multicast Switching.”](#)

Multicast traffic has its own global disposition. By default, the global disposition is **accept**. To change the default, use the **qos default multicast disposition** command.

For multicast filtering, the switch classifies traffic based on the multicast IP address or multicast network group and any destination parameters. Note that the destination parameters are used for the client from which the switch receives the IGMP request.

The **multicast ip** or **multicast network group** keyword is required in the condition configured for a multicast ACL.

The following keywords can be used in the condition to indicate the client parameters:

Multicast ACL Keywords

destination ip
destination vlan
destination port
destination port group
destination mac
destination mac group

If a destination group is specified, the corresponding single value keyword cannot be combined in the same condition. For example, if a destination port is specified, a destination port group cannot be specified in the same condition.

To filter multicast clients, specify the multicast IP address, which is the address of the multicast group or stream, and specify the client IP address, VLAN, MAC address, or chassis/slot/port. For example:

```
-> qos default multicast disposition deny
-> policy condition Mclient1 multicast ip 224.0.1.2 destination vlan 5
-> policy action ok disposition accept
-> policy rule Mrule condition Mclient1 action ok
```

In this example, any traffic coming in on VLAN 5 requesting membership to the 224.0.1.2 multicast group is allowed to pass through.

Using ACL Security Features

The following additional ACL features are available for improving network security and preventing malicious activity on the network:

- **UserPorts**—A port group that identifies its members as user ports to prevent source address spoofing of IP and ARP traffic (per RFC 2267). When a port is configured as a member of this group, packets received on the port are dropped if they contain a source IP address that does not match the IP subnet for the port. It is also possible to configure a UserPorts profile to specify other types of traffic to monitor on user ports. See [“Configuring a UserPorts Group” on page 27-60](#).
- **ICMP drop rules**—Allows condition combinations in policies that prevent user pings, thus reducing DoS exposure from pings. Two condition parameters are also available to provide more granular filtering of ICMP packets: **icmptype** and **icmrcode**. See [“Configuring ICMP Drop Rules” on page 27-61](#).
- **TCP connection rules**—Allows the determination of an *established* TCP connection by examining TCP flags found in the TCP header of the packet. Two condition parameters are available for defining a TCP connection ACL: **established** and **tcpflags**. See [“Configuring TCP Connection Rules” on page 27-61](#).
- **Early ARP discard**—ARP packets destined for other hosts are discarded to reduce processing overhead and exposure to ARP DoS attacks. No configuration is required to use this feature, it is

always available and active on the switch. Note that ARPs intended for use by a local subnet, AVLAN, VRRP, and Local Proxy ARP are *not* discarded.

- **ARP ACLs**—It is also possible to create an ACL that examines the source IP address in the header of ARP packets. This is done by specifying the ARP ethertype (0x0806) and source IP address.

Configuring a UserPorts Group

To prevent IP address spoofing and/or other types of traffic on specific ports, create a port group called **UserPorts** and add the ports to that group. For example, the following **policy port group** command adds ports 1/1/1-24, 1/2/1-24, 1/3/1, and 1/4/1 to the **UserPorts** group:

```
-> policy port group UserPorts 1/1/1-24 1/2/1-24 1/3/1 1/4/1
-> qos apply
```

Note that the UserPorts group applies to both bridged and routed traffic, and it is *not* necessary to include the UserPorts group in a condition and/or rule for the group to take effect. Once ports are designated as members of this group, IP spoofed traffic is blocked while normal traffic is still allowed on the port.

Configuring UserPort Traffic Types and Port Behavior

In addition to spoofed traffic, it is also possible to configure QoS to look for BPDU, RIP, OSPF, BGP, VRRP, and/or DHCP server packets on user ports. When the specified type of traffic is encountered, the user port can either filter the traffic or administratively shutdown to block all traffic.

By default spoofed traffic is filtered on user ports. To specify additional types of traffic to look for on these ports and select how the port deals with such traffic, use the **qos user-port** command to configure a UserPorts profile. For example, the following command specifies that user ports must filter BPDU packets:

```
-> qos user-port filter spoof
```

To specify multiple types of traffic on the same command line, enter each type separated by a space. For example:

```
-> qos user-port filter ospf bgp rip
```

Note that a slot and port is not required with the **qos user-port** command. This is because the command applies to all ports that are members of the UserPorts group.

The following **qos user-port** command example uses the **shutdown** option to administratively disable the user port if the specified type of traffic is received on that port:

```
-> qos user-port shutdown bpdu
```

Note that an SNMP trap is sent whenever a user port shutdown occurs. To enable a port disabled by a user port shutdown operation, use the **interfaces** command to administratively enable the port or disconnect and reconnect the port cable.

To disable the filter or shutdown function, use the **no** form of the **qos user-port** command. For example, the following command disables the filtering operation for all user ports:

```
-> qos no user-port filter
```

Note that any changes to the UserPorts profile (for example, adding or removing a traffic type) are not made until the **qos apply** command is performed.

Configuring ICMP Drop Rules

Combining a Layer 2 condition for source VLAN with a Layer 3 condition for IP protocol is supported. In addition, two new condition parameters are available to provide more granular filtering of ICMP packets: **icmptype** and **icmrcode**. Use these two conditions together in a policy to block ICMP echo request and reply packets without impacting switch performance.

The following example defines an ACL policy that prevents users from pinging by dropping echo request ICMP packets at the source port:

```
-> policy condition pingEchoRequest source vlan 10 icmptype 8
-> policy action drop disposition drop
-> policy rule noping10 condition pingEchoRequest action drop
-> qos apply
```

Note that the above policy only blocks ICMP echo traffic, all other ICMP traffic is still allowed.

Configuring TCP Connection Rules

Two condition parameters are available for defining a TCP connection ACL policy: **established** and **tcpflags**. An ACL can be defined using the **established** parameter to identify packets that are part of an established TCP connection and allow forwarding of the packets to continue. When this parameter is invoked, TCP header information is examined to determine if the **ack** or **rst** flag bit is set. If this condition is true, then the connection is considered established.

The following is an example ACL policy using the **established** condition parameter:

```
policy condition c destination ip 192.168.10.0 mask 255.255.255.0 established
policy condition c1 destination ip 192.168.10.0 mask 255.255.255.0
policy action drop disposition drop
policy action allow

policy rule r condition c action allow
policy rule r1 condition c1 action drop
qos apply
```

This example ACL policy prevents any TCP connection from being initiated to the 192.168.10.0 network and all other IP traffic to the 192.168.10.0 network. Only TCP connections initiated from the 192.168.10.0 network are allowed.

Note that the above example ACL would prevent FTP sessions. See the [policy condition established](#) command page in the *OmniSwitch AOS Release 8 CLI Reference Guide* for more information.

An ACL can also be defined using the **tcpflags** parameter to examine and qualify specific TCP flags individually or in combination with other flags. This parameter can be used to prevent specific DOS attacks, such as the *christmas tree*.

The following example use the **tcpflags** condition parameter to determine if the F (fin) and S (syn) TCP flag bits are set to one and the A (ack) bit is set to zero:

```
-> policy condition c1 tcpflags all f s mask f s a
```

In this example, a match must occur on all the flags or the packet is not allowed. If the optional command keyword **any** was used, then a match need only occur on any one of the flags. For example, the following condition specifies that either the A (ack) bit or the R (rst) bit must equal one:

```
-> policy condition c1 tcpflags any a r mask a r
```

Note that if a flag is specified on the command line after the **any** or **all** keyword, then the match value is one. If the flag only appears as part of the **mask**, then the match value is zero. See the **policy condition tcpflags** command page in the *OmniSwitch AOS Release 8 CLI Reference Guide* for more information.

Applying the Configuration

Configuration for policy rules and many global QoS parameters must specifically be applied to the configuration with the **qos apply** command. Any parameters configured without this command are maintained for the current session but are not yet activated. For example, if you configure a new policy rule through the **policy rule** command, the switch cannot use it to classify traffic and enforce the policy action until the **qos apply** command is entered. For example:

```
-> policy rule my_rule condition c4 action a5
-> qos apply
```

The **qos apply** command must be included in an ASCII text configuration file when QoS commands are included. The command must be included after the last QoS command.

When the configuration is not yet applied, it is referred to as the *pending configuration*.

Global Commands. Many global QoS commands are active immediately on the switch *without qos apply*. *The settings configured by these commands become active immediately*. Other global commands must specifically be applied. The commands are listed in the following table:

Global Commands That Take Effect Immediately	
qos	qos trust ports
qos forward log	qos stats interval
qos log console	qos revert
qos log lines	qos flush
qos log level	qos reset
debug qos	

Port and Policy Commands. All port parameters and policy parameters must be applied with the **qos apply** command.

Port and Policy Commands	
qos port	policy service
policy condition	policy service group
policy action	policy mac group
policy rule	policy port group
policy network group	policy map group

The pending configuration is useful for reviewing policy rules before actually applying them to the switch.

Applied policy rules can also be administratively disabled (inactive). If a rule is administratively disabled, the rule exists in the applied configuration but does not be used to classify flows. For more information about disabling/re-enabling a policy rule, see [“Creating Policy Rules” on page 27-39](#).

Deleting the Pending Configuration

Policy settings that have been configured but not applied through the **qos apply** command can be returned to the last applied settings through the **qos revert** command. For example:

```
-> qos revert
```

This command ignores any pending policies (any additions, modifications, or deletions to the policy configuration since the last **qos apply**) and writes the last applied policies to the pending configuration. At this point, the pending policies are the same as the last applied policies.

In this example, there are two new pending policies and three applied policies:

Pending Policies	Applied Policies
rule5	rule1
rule6	rule2
	rule3

If you enter **qos revert**, the configuration then looks like:

Pending Policies	Applied Policies
rule1	rule1
rule2	rule2
rule3	rule3

Flushing the Configuration

In some cases, when you need to remove all of your rules and start over again, erase the pending policies completely from the configuration, use the **qos flush** command. For example:

```
-> qos flush
```

If you then enter **qos apply**, all policy information is deleted.

In this example, there are two new pending policies and three applied policies:

Pending Policies	Applied Policies
rule5	rule1
rule6	rule2
	rule3

If you enter **qos flush**, the configuration then looks like:

Pending Policies	Applied Policies
	rule1
	rule2
	rule3

In this scenario, you can do one of two things. To write the applied policies back to the pending configuration, use **qos revert**. Or, to delete all policy rule configuration, enter **qos apply**. If **qos apply** is entered, the empty set of pending policies are written to the applied policies and all policy rule configuration is deleted.

Interaction With LDAP Policies

The **qos apply**, **qos revert**, and **qos flush** commands do not affect policies created through the PolicyView application. Separate commands are used for loading and flushing LDAP policies on the switch. See [Chapter 29, “Managing Authentication Servers,”](#) for information about managing LDAP policies.

Verifying the Applied Policy Configuration

The policy **show** commands have an optional keyword (**applied**) to display only applied policy objects. These commands include:

show policy condition	Displays information about all pending and applied policy conditions or a particular policy condition configured on the switch. Use the applied keyword to display information about applied conditions only.
show policy action	Displays information about all pending and applied policy actions or a particular policy action configured on the switch. Use the applied keyword to display information about applied actions only.
show policy rule	Displays information about all pending and applied policy rules or a particular policy rule. Use the applied keyword to display information about applied rules only.
show policy network group	Displays information about all pending and applied policy network groups or a particular network group. Use the applied keyword to display information about applied groups only.
show policy service	Displays information about all pending and applied policy services or a particular policy service configured on the switch. Use the applied keyword to display information about applied services only.
show policy service group	Displays information about all pending and applied policy service groups or a particular service group. Use the applied keyword to display information about applied groups only.
show policy mac group	Displays information about all pending and applied MAC groups or a particular policy MAC group configured on the switch. Use the applied keyword to display information about applied groups only.
show policy port group	Displays information about all pending and applied policy port groups or a particular port group. Use the applied keyword to display information about applied groups only.
show policy map group	Displays information about all pending and applied policy map groups or a particular map group. Use the applied keyword to display information about applied groups only.

For more information about these commands, see the *OmniSwitch AOS Release 8 CLI Reference Guide*.

Policy Applications

Policies are used to classify incoming flows and treat the relevant outgoing flows. There are many ways to classify the traffic and many ways to apply QoS parameters to the traffic.

Classifying traffic can be as simple as identifying a Layer 2 or Layer 3 address of an incoming flow. Treating the traffic might involve prioritizing the traffic or rewriting an IP address. How the traffic is treated (the *action* in the policy rule) typically defines the type of policy:

Type of Policy	Description	Action Parameters Used
Basic QoS policies	Prioritizes and polices particular flows.	maximum bandwidth maximum depth priority cir cbs pir pbs
Redirection policies	Redirects flows to a specific port or link aggregate ID.	redirect port redirect linkagg
Policy Based Mirroring	Mirrors ingress and egress packets to a specific port.	ingress mirror egress mirror ingress egress mirror
ICMP policies	Filters, prioritizes, and/or rate limits ICMP traffic	disposition priority maximum bandwidth
802.1p, ToS, and DSCP tagging or mapping policies	Sets or resets the egress 802.1p, ToS, or DSCP values	802.1p tos dscp map group
Policy Based Routing (PBR)	Redirects routed traffic.	permanent ip
Access Control Lists (ACLs)	Groups of policies rules used for filtering traffic (allow/deny)	disposition

This section describes how to configure basic QoS policies and 802.1p/ToS/DSCP marking and mapping policies. Policies used for Layer 2 and Layer 3/4 filters, are commonly referred to as Access Control Lists (ACLs). Filtering is discussed in [Chapter 27, “Configuring QoS.”](#)

Policies can also be used for prioritizing traffic in dynamic link aggregation groups. For more information about dynamic link aggregates, see [Chapter 10, “Configuring Dynamic Link Aggregation.”](#)

Basic QoS Policies

Traffic prioritization and bandwidth policing can be the most common types of QoS policies. For these policies, any condition can be created; the policy action indicates how the traffic must be prioritized or how the bandwidth must be shaped.

Note. If multiple addresses, services, or ports must be given the same priority, use a policy condition group to specify the group and associate the group with the condition. See [“Using Condition Groups in Policies” on page 27-45](#) for more information about groups.

Note that some condition parameters can be used in combination only under particular circumstances; also, there are restrictions on condition/action parameter combinations. See [“Policy Conditions” on page 27-23](#) and [“Policy Actions” on page 27-24](#).

Basic Commands

The following **policy action** commands are used for traffic prioritization or policing (rate limiting):

policy action priority
policy action maximum bandwidth
policy action maximum depth

To set up traffic prioritization and/or bandwidth policing, follow the steps in the next section. For more information about command syntax and options, see the *OmniSwitch AOS Release 8 CLI Reference Guide*.

Note that QoS ports can also be configured for bandwidth shaping through the **qos port maximum ingress-bandwidth** and **qos port maximum egress-bandwidth** commands.

Traffic Prioritization Example

In this example, IP traffic is routed from the 10.10.4.0 network through the OmniSwitch.

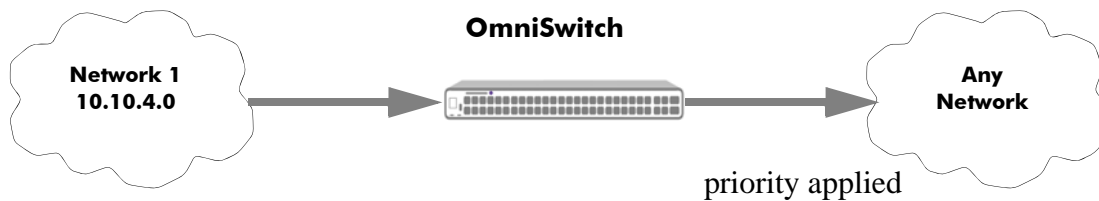

To create a policy rule to prioritize the traffic from Network 1, first create a condition for the traffic that you want to prioritize. In this example, the condition is called **ip_traffic**. Then create an action to prioritize the traffic as highest priority. In this example, the action is called **high**. Combine the condition and the action into a policy rule called **rule1**.

```

-> policy condition ip_traffic source ip 10.10.4.0 mask 255.255.255.0
-> policy action high priority 7
-> policy rule rule1 condition ip_traffic action high
  
```

The rule is not active on the switch until the **qos apply** command is entered on the command line. When the rule is activated, any flows coming into the switch from 10.10.4.0 is given the highest priority.

Bandwidth Policing Example

In this example, a maximum bandwidth rate is effected on flows from a specific source IP address.

First, create a condition for the traffic. In this example, the condition is called **ip_traffic2**. A policy action (**flowShape**) is then created to enforce a maximum bandwidth requirement for the flow.

```

-> policy condition ip_traffic2 source ip 10.10.5.3
-> policy action flowShape maximum bandwidth 10m
-> policy action burst maximum depth 1m
-> policy rule rule2 condition traffic2 action flowShape action burst
  
```

Note that the bandwidth can be specified in abbreviated units, in this case, **1k**. The rule is not active on the switch until the **qos apply** command is entered.

Redirection Policies

A redirection policy sends traffic that matches the policy to a specific port or link aggregate instead of the originally intended destination. This type of policy can use any condition; the policy action determines which port or link aggregate to which the traffic is sent.

The following **policy action** commands are used for port and link aggregate redirection:

policy action redirect port
policy action redirect linkagg

Note the following regarding the use and configuration of redirection policies:

- Redirection policies apply to both bridged and routed traffic.
- When redirecting routed traffic from VLAN A to VLAN B, the redirect port or link aggregate ID must belong to VLAN B (tagged or default VLAN).
- Routed packets (from VLAN A to VLAN B) are not modified after they are redirected; the source and MAC address remain the same. In addition, if the redirect port or link aggregate ID is tagged, the redirected packets have a tag from the ingress VLAN A.
- If a route exists for the redirected flow, then redirected packets are the final post-routing packets.
- If a route does not exist for the redirected flow, the flow is not redirected to the specified port or link aggregate ID and is “blackholed”. As soon as a route is available, the flow is then redirected as specified in the policy.
- In most cases, a redirected flow does *not* trigger an update to the routing and ARP tables. When the ARP table is cleared or timed out, port/link aggregate redirection cease until the ARP table is refreshed. If necessary, create a static route for the flow or assign the redirect port or link aggregate ID to the ingress VLAN (VLAN A) to send packets to the redirect port until a route is available.
- When redirecting bridged traffic on VLAN A, the redirect port or link aggregate ID must belong to VLAN A (tagged or default VLAN).

In the following example, flows destined for UDP port 80 is redirected to switch port 3/2:

```
-> policy condition L4PORTCOND destination udp port 80
-> policy action REDIRECTPORT redirect port 1/3/2
-> policy rule L4PORTRULE condition L4PORTCOND action REDIRECTPORT
```

In the following example, flows destined for IP address 40.2.70.200 are redirected to link aggregate 10:

```
-> policy condition L4LACOND destination IP 40.2.70.200
-> policy action REDIRECTLA redirect linkagg 10
-> policy rule L4LARULE condition L4LACOND action REDIRECTLA
```

Note that in both examples above, the rules are not active on the switch until the **qos apply** command is entered on the command line.

Policy Based Mirroring

A mirroring policy sends a copy of ingress, egress, or both ingress and egress packets that match the policy condition to a specific port. This type of policy can use any condition; the mirror policy action determines the type of traffic to mirror and the port on which the mirrored traffic is received.

The **policy action mirror** command is used to configure mirror-to-port (MTP) action for the policy. For example, the following policy mirrors ingress packets to port 1/1/10:

```
-> policy condition c1 source ip 192.168.20.1
-> policy action a1 mirror ingress 1/1/10
-> policy rule r1 condition c1 action a1
-> qos apply
```

When the above rule is activated, any flows coming into the switch from source IP address 192.168.20.1 are mirrored to port 1/1/10. It is also possible to combine the MTP action with other actions. For example:

```
-> policy condition c1 source ip 192.168.20.1
-> policy action a1 mirror ingress 1/1/10 disposition drop
-> policy rule r1 condition c1 action a1
-> qos apply
```

This policy rule example combines the MTP action with the drop action. As a result, this rule drops ingress traffic with a source IP of 192.168.20.1, but the mirrored traffic from this source is not dropped and is forwarded to port 1/1/10.

Note the following regarding the use and configuration of mirroring policies:

- Only one policy-based MTP session is supported at any given time. As a result, all mirroring policies must specify the same destination port.
- In addition to one policy-based MTP session, the switch can support one port-based mirroring session, one remote port mirroring session, and one port monitoring session all running at the same time.
- Policy based mirroring and the port-based mirroring feature can run simultaneously on the same port.
- Rule precedence is applied to all mirroring policies that are configured for the same switch ASIC. If traffic matches a mirror rule on one ASIC with a lower precedence than a non-mirroring rule on a different ASIC, the traffic is mirrored in addition to the actions specified by the higher precedence rule.

ICMP Policy Example

Policies can be configured for ICMP on a global basis on the switch. ICMP policies can be used for security (for example, to drop traffic from the ICMP blaster virus).

In the following example, a condition called **icmpCondition** is created with no other condition parameters:

```
-> policy condition icmpCondition ip protocol 1
-> policy action icmpAction disposition deny
-> policy rule icmpRule condition icmpCondition action icmpAction
```

This policy (**icmpRule**) drops all ICMP traffic. To limit the dropped traffic to ICMP echo requests (pings) and/or replies, use the **policy condition icmpType** to specify the appropriate condition. For example,

```
-> policy condition echo icmpType 8
-> policy condition reply icmpType 0
```

802.1p and ToS/DSCP Marking and Mapping

802.1p values can be mapped to different 802.1p values on an individual basis or by using a map group. In addition, ToS or DSCP values can be mapped to 802.1p on a case-by-case basis or through a map group. (Note that any other mapping combination is not supported.)

Marking is accomplished with the following commands:

```
policy action 802.1p  
policy action tos  
policy action dscp
```

Mapping is accomplished through the following commands:

```
policy map group  
policy action map
```

Note the following:

- Priority for the flow is based on the policy action. The value specified for 802.1p, ToS, DSCP, or the map group determines how the flow is queued.
- The port on which the flow arrives (the ingress port) must be a trusted port. For more information about trusted ports, see [“Configuring Trusted Ports” on page 27-7](#).

In this example, a policy rule (**marking**) is set up to mark flows from 10.10.3.0 with an 802.1p value of 5:

```
-> policy condition my_condition source ip 10.10.3.0 mask 255.255.255.0  
-> policy action my_action 802.1p 5  
-> policy rule marking condition my_condition action my_action
```

In the next example, the **policy map group** command specifies a group of values that must be mapped; the **policy action map** command specifies what must be mapped (802.1p to 802.1p, ToS/DSCP to 802.1p) and the mapping group that must be used. For more details about creating map groups, see [“Creating Map Groups” on page 27-53](#).

Here, traffic from two different subnets must be mapped to 802.1p values in a network called Network C. A map group (**tosGroup**) is created with mapping values.

```
-> policy map group tos_group 1-4:4 5-7:7  
-> policy condition SubnetA source ip 10.10.5.0 mask 255.255.255.0  
-> policy condition SubnetB source ip 12.12.2.0 mask 255.255.255.0  
-> policy action map_action map tos to 802.1p using tos_group
```

The **map_action** specifies that ToS values is mapped to 802.1p with the values specified in **tos_group**. With these conditions and action set up, two policy rules can be configured for mapping Subnet A and Subnet B to the ToS network:

```
-> policy rule RuleA condition SubnetA action map_action  
-> policy rule RuleB condition SubnetB action map_action
```

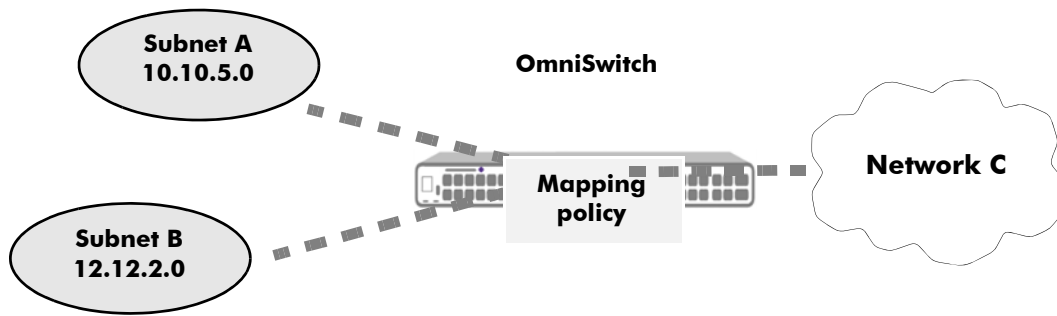

Mapping Application

Policy Based Routing

Policy Based Routing (PBR) allows a network administrator to define QoS policies that override the normal routing mechanism for traffic matching the policy condition.

Note. Note. When a PBR QoS rule is applied to the configuration, it is applied to the entire switch, unless you specify a built-in port group in the policy condition.

Policy Based Routing can be used to redirect traffic to a particular gateway based on source or destination IP address, source or destination network group, source or destination TCP/UDP port, a service or service group, IP protocol, or built-in source port group.

Traffic can be redirected to a particular gateway regardless of what routes are listed in the routing table. Note that the gateway address does not have to be on a directly connected VLAN; the address can be on any network that is learned by the switch.

Note. Note. the routing table has a default route of 0.0.0.0, traffic matching a PBR policy is redirected to the route specified in the policy. For information about viewing the routing table, see [Chapter 16, “Configuring IP.”](#)

Policy Based Routing can be used to redirect untrusted traffic to a firewall. In this case, note that reply packets are not allowed back through the firewall.

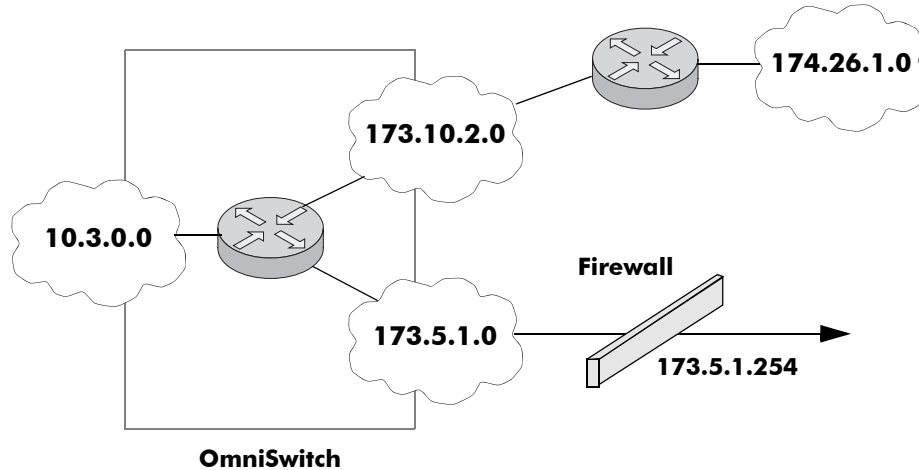

Routing all IP source traffic through a firewall

In this example, all traffic originating in the 10.3 network is routed through the firewall, regardless of whether or not a route exists.

```
-> policy condition Traffic3 source ip 10.3.0.0 mask 255.255.0.0
-> policy action Firewall permanent gateway ip 173.5.1.254
-> policy rule Redirect_All condition Traffic3 action Firewall
```

Note that the functionality of the firewall is important. In the example, the firewall is sending the traffic to be routed remotely. If you instead set up a firewall to send the traffic back to the switch to be routed, you must set up the policy condition with a built-in source port group so that traffic coming back from the firewall does not get looped and sent back out to the firewall. For example:

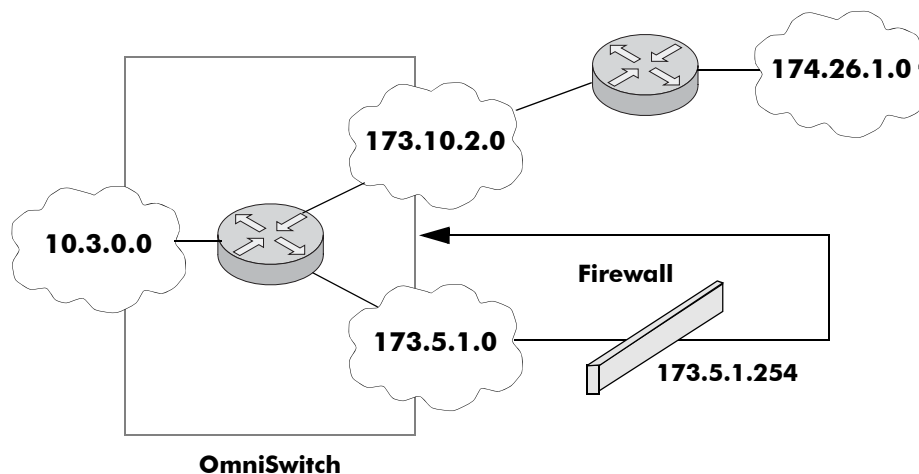

Using a Built-In Port Group

In this scenario, traffic from the firewall is sent back to the switch to be re-routed. But because the traffic re-enters the switch through a port that is not in the Slot01 port group, the traffic does not match the Redirect_All policy and is routed normally through the switch.

```

-> policy condition Traffic3 source ip 10.3.0.0 mask 255.255.0.0 source port
group Slot01
-> policy action Firewall permanent gateway ip 173.5.1.254
-> policy rule Redirect_All condition Traffic3 action Firewall

```

Make sure to enter the **qos apply** command to activate the policy rule on the switch. Otherwise the rule is saved as part of the pending configuration, but is not active.

Non-Contiguous Masks

Non-contiguous masks expand the accepted inputs for the Access Control List (ACL) netmask to facilitate load distribution through Policy Based Routing (PBR). The feature allows masks consisting of any combination of zeros (0) and ones (1). Previously only traditional netmasks were supported and only allowed up to eight bits of zeros to be sparsely distributed in the mask. Traditional netmasks begin with ones followed by a contiguous sequence of zeros (for example, 255.255.255.0). The non-contiguous mask feature supports IPv4 and IPv6 address masks in policy condition statements that contain any sequence of zeros and ones.

The following example illustrates how ACLs can be used to select a subset of the source IP address to be matched and then routed to various gateway-IP addresses using conditions, actions, and rules. The next-hop gateway-IP address must be on a subnet that the router has a directly connected interface for.

Non-contiguous mask examples

A network administrator wishes to distribute IPv4 traffic from the 12.0.0.0 network to a group of servers. In this example there are eight servers that can perform the requested service and the traffic can be distributed depending on the source IP address. These servers reside at addresses 10.0.0.1, 10.0.0.2, 10.0.0.3, 10.0.0.4, 10.0.0.5, 10.0.0.6, 10.0.0.7 and 10.0.0.8.

The policy condition commands define a condition that will match one of eight large sets of source IPv4 addresses. The zeros in the mask define don't care or any value matches. The ones in the mask define the care bits that must match the portion of the address defined by the source IP portion of the command. The first condition command matches the source IP address set described as follows:

- 12.any.any.0
- 12.any.any.8
- 12.any.any.16
- 12.any.any.(0+(n*8))

The policy action commands direct the set of source addresses to a specific IP address. The policy rule commands combine the condition and action to form the specific behavior.

```

-> policy condition c1 source ip 12.0.0.0 mask 255.0.0.7
-> policy action a1 permanent gateway-ip 10.0.0.1
-> policy rule r1 condition c1 action a1

! route 1,9,17,33,(1+(n*8))
-> policy condition c2 source ip 12.0.0.1 mask 255.0.0.7
-> policy action a2 permanent gateway-ip 10.0.0.2
-> policy rule r2 condition c2 action a2

! route 2,10,18,34,(2+(n*8))
-> policy condition c3 source ip 12.0.0.2 mask 255.0.0.7
-> policy action a3 permanent gateway-ip 10.0.0.3
-> policy rule r3 condition c3 action a3

! route 3,11,19,35,(3+(n*8))
-> policy condition c4 source ip 12.0.0.3 mask 255.0.0.7

```

```

-> policy action a4 permanent gateway-ip 10.0.0.4
-> policy rule r4 condition c4 action a4

! route 4,12,20,36,(4+(n*8))
-> policy condition c5 source ip 12.0.0.4 mask 255.0.0.7
-> policy action a5 permanent gateway-ip 10.0.0.5
-> policy rule r5 condition c5 action a5

! route 5,13,21,37,(5+(n*8))
-> policy condition c6 source ip 12.0.0.5 mask 255.0.0.7
-> policy action a6 permanent gateway-ip 10.0.0.6
-> policy rule r6 condition c6 action a6

! route 6,14,22,38,(6+(n*8))
-> policy condition c7 source ip 12.0.0.6 mask 255.0.0.7
-> policy action a7 permanent gateway-ip 10.0.0.7
-> policy rule r7 condition c7 action a7

! route 7,15,23,39,(7+(n*8))
-> policy condition c8 source ip 12.0.0.7 mask 255.0.0.7
-> policy action a8 permanent gateway-ip 10.0.0.8
-> policy rule r8 condition c8 action a8
-> qos apply

```

Note the following regarding the use and configuration of IPv4 non-contiguous masks.

- Automatic resolution through Address Resolution Protocol (ARP) for next-hop (permanent gateway-IP) addresses is not supported if a mask contains more than 8-bits of non-contiguous zeros. As a result, other mechanisms have to be used to resolve the MAC addresses such as server load balancing ping probing or static ARP entries.
- A Server Load Balancing (SLB) configuration can be used to probe IPv4 addresses. This allows for dynamic resolution of the IPv4 next hop policy based route. For example:

```

-> vlan 14 admin-state enable
-> vlan 14 members port 1/1/14 untagged
-> ip interface "v4_v14" vlan 14 admin-state enable
-> ip address 10.0.0.254
-> ip slb cluster pbr_servers vip 1.2.3.4
-> ip slb server ip 10.0.0.1 cluster pbr_servers
-> ip slb server ip 10.0.0.2 cluster pbr_servers
-> ip slb server ip 10.0.0.3 cluster pbr_servers
-> ip slb server ip 10.0.0.3 cluster pbr_servers
-> ip slb server ip 10.0.0.4 cluster pbr_servers
-> ip slb server ip 10.0.0.5 cluster pbr_servers
-> ip slb server ip 10.0.0.6 cluster pbr_servers
-> ip slb server ip 10.0.0.7 cluster pbr_servers

-> ip slb cluster pbr_servers ping period 1
-> ip slb cluster pbr_servers ping timeout 1000

```

IPv6 example using an IPv6 gateway address

```

-> policy condition c9 source ipv6 2000::1 mask e000::7
-> policy action a9 permanent gateway-ipv6 2607:f0d0:2001:000a:0000:0000:0010
-> policy rule r9 condition c9 action a9
-> qos apply

```

28 Managing Policy Servers

Quality of Service (QoS) policies that are configured through Alcatel-Lucent's PolicyView network management application are stored on a Lightweight Directory Access Protocol (LDAP) server. PolicyView is an OmniVista application that runs on an attached workstation.

In This Chapter

This chapter describes how LDAP directory servers are used with the switch for policy management. There is no required configuration on the switch. When policies are created on the directory server through PolicyView, the PolicyView application automatically configures the switch to communicate with the server. This chapter includes information about modifying configuration parameters through the Command Line Interface (CLI) if manual reconfiguration is necessary. For more details about the syntax of commands, see the *OmniSwitch AOS Release 8 CLI Reference Guide*.

Throughout this chapter the term *policy server* is used to refer to LDAP directory servers used to store policies. Procedures described in this chapter include:

- [“Installing the LDAP Policy Server” on page 28-3](#)
- [“Modifying Policy Servers” on page 28-4](#)
- [“Verifying the Policy Server Configuration” on page 28-7](#)

Policy Server Specifications

The following table lists important information about LDAP policy servers:

Platforms Supported	OmniSwitch 6860, 6860E
LDAP Policy Servers RFCs Supported	RFC 2251–Lightweight Directory Access Protocol (v3) RFC 3060–Policy Core Information Model—Version 1 Specification
Maximum number of policy servers (supported on the switch)	5
Maximum number of policy servers (supported by PolicyView)	1

Policy Server Defaults

Defaults for the **policy server** command are as follows:

Description	Keyword	Default
The port number for the server	port	389 (SSL disabled) 636 (SSL enabled)
Priority value assigned to a server, used to determine search order	preference	0 (lowest)
Whether a Secure Socket Layer is configured for the server	ssl no ssl	no ssl

Policy Server Overview

The Lightweight Directory Access Protocol (LDAP) is a standard directory server protocol. The LDAP policy server client in the switch is based on RFC 2251. Currently, only LDAP servers are supported for policy management.

When the policy server is connected to the switch, the switch is automatically configured to communicate with the server to download and manage policies created by the PolicyView application. There is no required user configuration. (Note that the LDAP policy server is automatically installed when the PolicyView application is installed.)

Note. The switch has separate mechanisms for managing QoS policies stored on an LDAP server and QoS policies configured directly on the switch. For more information about creating policies directly on the switch, see [Chapter 27, “Configuring QoS.”](#)

Information about installing the LDAP policy server is included in this chapter. Consult the server manufacturer documentation for detailed information about configuring the server.

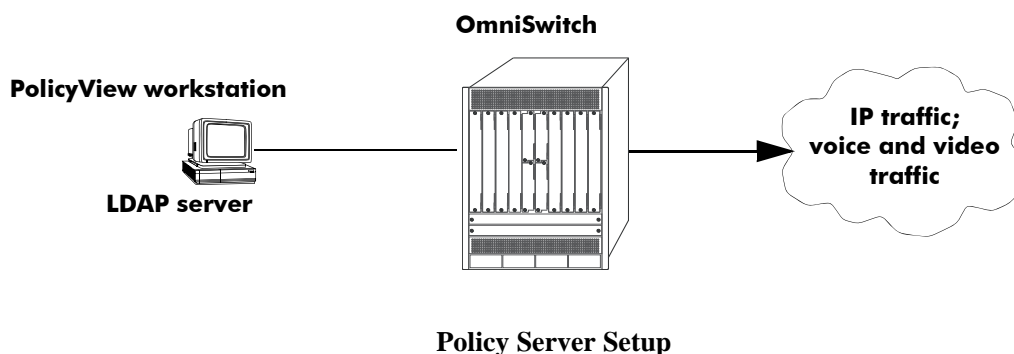

Installing the LDAP Policy Server

Currently Netscape Directory Server 4.15 is supported. The server software is bundled with the PolicyView NMS application.

- 1 Install the directory server software on the server.
- 2 Install the Java Runtime Environment on the server.

See your server documentation for additional details on setting up the server.

See the next sections of this chapter for information about modifying policy server parameters or viewing information about policy servers.

Modifying Policy Servers

Policy servers are automatically configured when the server is installed; however, policy server parameters can be modified if necessary.

Note. SSL configuration must be done manually through the **policy server** command.

Modifying LDAP Policy Server Parameters

Use the **policy server** command to modify parameters for an LDAP policy server.

Keywords for the command are listed here:

Policy server keywords

port	password
admin	searchbase
preference	ssl
user	

For information about policy server parameter defaults, see [“Policy Server Defaults” on page 28-2](#).

Disabling the Policy Server From Downloading Policies

Policy servers can be prevented from downloading policies to the switch. By default, policy servers are enabled to download policies.

To disable a server, use the **policy server** command with the **admin-state** keyword and **disable** option.

```
-> policy server 10.10.2.3 admin-state disable
```

In this example, an LDAP server with an IP address of 10.10.2.3 is not used to download policies. Any policies already downloaded to the switch are not affected by disabling the server.

To re-enable the server, specify **enable**.

```
-> policy server 10.10.2.3 admin-state enable
```

The server is now available for downloading policies.

To delete a policy server from the configuration, use the **no** form of the command with the relevant IP address:

```
-> no policy server 10.10.2.3
```

If the policy server is not created on the default port, the **no** form of the command must include the port number. For example:

```
-> no policy server 10.10.2.4 5000
```

Modifying the Port Number

To modify the port, enter the **policy server** command with the **port** keyword and the relevant port number.

```
-> policy server 10.10.2.3 port 5000
```

Note that the port number must match the port number configured on the policy server.

If the port number is modified, any existing entry for that policy server is not removed. Another entry is simply added to the policy server table.

Note. If you enable SSL, the port number is automatically set to 636. (This does not create another entry in the port table.)

For example, if you configure a policy server with port 389 (the default), and then configure another policy server with the same IP address but port number 5000, two entries display on the **show policy server** screen.

```
-> policy server 10.10.2.3
-> policy server 10.10.2.3 port number 5000
-> show policy server
```

Server	IP Address	port	enabled	status	primary
1	10.10.2.3	389	Yes	Up	X
2	10.10.2.3	5000	No	Down	-

To remove an entry, use the **no** form of the **policy server** command. For example:

```
-> no policy server 10.10.2.3 port number 389
```

The first entry is removed from the policy server table.

Modifying the Policy Server Username and Password

A user name and password can be specified so that only specific users can access the policy server.

```
-> policy server 10.10.2.3 user kandinsky password blue
```

If this command is entered, a user with a username of **kandinsky** and a password of **blue** is able to access the LDAP server to modify parameters on the server itself.

Modifying the Searchbase

The searchbase name is "o=alcatel.com" by default. To modify the searchbase name, enter the **policy server** command with the **searchbase** keyword. For example:

```
-> policy server 10.10.2.3 searchbase "ou=qo,o=company,c=us"
```

Note that the search-base path must be a valid path in the server directory structure.

Configuring a Secure Socket Layer for a Policy Server

A Secure Socket Layer (SSL) can be configured between the policy server and the switch. If SSL is enabled, the PolicyView application can no longer write policies to the LDAP directory server.

By default, SSL is disabled. To enable SSL, use the **policy server** command with the **ssl** option. For example:

```
-> policy server 10.10.2.3 ssl
```

SSL is now enabled between the specified server and the switch. The port number in the switch configuration is automatically set to 636, which is the port number typically used for SSL; however, the port number must be configured with whatever port number is set on the server. For information about configuring the port number, see [“Modifying the Port Number” on page 28-5](#).

To disable SSL, use **no ssl** with the command:

```
-> policy server 10.10.2.3 no ssl
```

SSL is disabled for the 10.10.2.3 policy server. No additional policies can be saved to the directory server from the PolicyView application.

Loading Policies From an LDAP Server

To download policies (or rules) from an LDAP server to the switch, use the **policy server load** command. Before a server can download policies, it must also be set up and operational (able to bind).

To download policies from the server, enter the following:

```
-> policy server load
```

Use the **show policy server long** command to display the last load time. For example:

```
-> show policy server long
LDAP server 0
  IP address           : 10.10.2.3,
  TCP port             : 16652,
  Enabled              : Yes,
  Operational Status   : Down,
  Preference           : 99,
  Authentication       : password,
  SSL                  : Disabled,
  login DN             : cn=DirMgr
  searchbase           : o=company
  Last load time       : 02/14/12 16:38:18
```

Removing LDAP Policies From the Switch

To flush LDAP policies from the switch, use the **policy server flush** command. Note that any policies configured directly on the switch through the CLI *are not affected* by this command.

```
-> policy server flush
```

Interaction With CLI Policies

Policies configured through PolicyView can only be modified through PolicyView. They cannot be modified through the CLI. Any policy management done through the CLI only affects policies configured through the CLI. For example, the **qos flush** command only removes CLI policies; LDAP policies are not affected.

Also, the **policy server flush** command removes only LDAP policies; CLI policies are not affected.

Note. If policies are applied from PolicyView or vice versa, it activates all current configuration.

For more information about configuring policies through the CLI, see [Chapter 27, “Configuring QoS.”](#)

Verifying the Policy Server Configuration

To display information about authentication and policy servers, use the following commands:

show policy server	Displays information about servers from which policies can be downloaded to the switch.
show policy server long	Displays detailed information about an LDAP policy server.
show policy server statistics	Displays statistics about policy directory servers.
show policy server rules	Displays the names of policies originating on a directory server that have been downloaded to the switch.
show policy server events	Displays any events related to a directory server.

29 Managing Authentication Servers

This chapter describes authentication servers and how they are used with the switch. The types of servers described include Remote Authentication Dial-In User Service (RADIUS), Lightweight Directory Access Protocol (LDAP), Terminal Access Controller Access Control System (TACACS+), and SecurID ACE/Server.

In This Chapter

The chapter includes some information about attributes that must be configured on the servers, but it primarily addresses configuring the switch through the Command Line Interface (CLI) to communicate with the servers to retrieve authentication information about users.

Configuration procedures described include:

- **Configuring a RADIUS Server.** This procedure is described in [“RADIUS Servers”](#) on page 29-7.
- **Configuring a TACACS+ Server.** This procedure is described in [“TACACS+ Server”](#) on page 29-12.
- **Configuring an LDAP Server.** This procedure is described in [“LDAP Servers”](#) on page 29-14.

For information about using servers for authenticating users to manage the switch, see the “Switch Security” chapter in the *OmniSwitch AOS Release 8 Switch Management Guide*.

Authentication Server Specifications

Platforms Supported	OmniSwitch 6860, 6860E
RADIUS RFCs Supported	<p>RFC 2865–Remote Authentication Dial In User Service (RADIUS)</p> <p>RFC 2866–RADIUS Accounting</p> <p>RFC 2867–RADIUS Accounting Modifications for Tunnel Protocol Support</p> <p>RFC 2868–RADIUS Attributes for Tunnel Protocol Support</p> <p>RFC 2809–Implementation of L2TP Compulsory Tunneling through RADIUS</p> <p>RFC 2869–RADIUS Extensions</p> <p>RFC 2548–Microsoft Vendor-specific RADIUS Attributes</p> <p>RFC 2882–Network Access Servers Requirements: Extended RADIUS Practices</p>
TACACS+ RFCs Supported	RFC 1492–An Access Control Protocol
LDAP RFCs Supported	<p>RFC 1789–Connectionless Lightweight X.5000 Directory Access Protocol</p> <p>RFC 2247–Using Domains in LDAP/X.500 Distinguished Names</p> <p>RFC 2251–Lightweight Directory Access Protocol (v3)</p> <p>RFC 2252–Lightweight Directory Access Protocol (v3): Attribute Syntax Definitions</p> <p>RFC 2253–Lightweight Directory Access Protocol (v3): UTF-8 String Representation of Distinguished Names</p> <p>RFC 2254–The String Representation of LDAP Search Filters</p> <p>RFC 2256–A Summary of the X.500(96) User Schema for Use with LDAPv3</p>
Other RFCs	<p>RFC 2574–User-based Security Model (USM) for version 3 of the Simple Network Management Protocol (SNMPv3)</p> <p>RFC 2924–Accounting Attributes and Record Formats</p> <p>RFC 2975–Introduction to Accounting Management</p> <p>RFC 2989–Criteria for Evaluating AAA Protocols for Network Access</p>
Maximum number of authentication servers in single authority mode	8
Maximum number of authentication servers in multiple authority mode	8
Maximum number of servers per Authenticated Switch Access type	8

Server Defaults

The defaults for authentication server configuration on the switch are listed in the tables in the next sections.

RADIUS Authentication Servers

Defaults for the [aaa radius-server](#) command are as follows:

Description	Keyword	Default
Number of retries on the server before the switch tries a backup server	retransmit	3
Timeout for server replies to authentication requests	timeout	2
UDP destination port for authentication	auth-port	1645*
UDP destination port for accounting	acct-port	1646*

* The port defaults are based on the older RADIUS standards; some servers are set up with port numbers based on the newer standards (ports 1812 and 1813, respectively).

TACACS+ Authentication Servers

Defaults for the [aaa tacacs+-server](#) command are as follows:

Description	Keyword	Default
Timeout for server replies to authentication requests	timeout	2
The port number for the server	port	49

LDAP Authentication Servers

Defaults for the [aaa ldap-server](#) command are as follows:

Description	Keyword	Default
The port number for the server	port	389 (SSL disabled) 636 (SSL enabled)
Number of retries on the server before the switch tries a backup server	retransmit	3
Timeout for server replies to authentication requests	timeout	2
Whether a Secure Socket Layer is configured for the server	ssl no ssl	no ssl

Quick Steps For Configuring Authentication Servers

- 1 For RADIUS, TACACS+, or LDAP servers, configure user attribute information on the servers. See [“RADIUS Servers” on page 29-7](#), [“TACACS+ Server” on page 29-12](#), and [“LDAP Servers” on page 29-14](#).
- 2 Use the **aaa radius-server**, **aaa tacacs+-server**, and/or the **aaa ldap-server** command to configure the authentication server(s). For example:

```
-> aaa radius-server rad1 host 10.10.2.1 10.10.3.5 key amadeus
-> aaa tacacs+-server tac3 host 10.10.4.2 key otna timeout 10
-> aaa ldap-server ldap2 host 10.10.3.4 dn cn=manager password tpub base c=us
```

Note. (Optional) Verify the server configuration by entering the **show aaa server** command. For example:

```
-> show aaa server
Server name = rad1
  Server type           = RADIUS,
  IP Address 1         = 10.10.2.1,
  IP Address 2         = 10.10.3.5
  Retry number         = 3,
  Timeout (in sec)     = 2,
  Authentication port  = 1645,
  Accounting port      = 1646
Server name = ldap2
  Server type           = LDAP,
  IP Address 1         = 10.10.3.4,
  Port                 = 389,
  Domain name          = cn=manager,
  Search base          = c=us,
  Retry number         = 3,
  Timeout (in sec)     = 2,
Server name = Tacacs1
  ServerIp             = 1.1.1.1
  ServerPort           = 49
  Encryption           = MD5
  Timeout              = 5 seconds
  Status               = UP
```

See the *CLI Reference Guide* for information about the fields in this display.

- 3 If you are using ACE/Server, there is no required switch configuration; however, you must FTP the **sdconf.rec** file from the server to the **/network** directory of the switch.
- 4 Configure authentication on the switch. This step is described in other chapters. For a quick overview of using the configured authentication servers with Authenticated Switch Access, see the *OmniSwitch AOS Release 8 Switch Management Guide*.

Server Overview

Authentication servers are sometimes referred to as AAA servers (authentication, authorization, and accounting). These servers are used for storing information about users who want to manage the switch (Authenticated Switch Access) and users who need access to a particular VLAN or VLANs (Authenticated VLANs).

RADIUS, TACACS +, or LDAP servers can be used for Authenticated Switch Access and/or Authenticated VLANs. Another type of server, SecurID ACE/Server, can be used for authenticated switch access only; the ACE/Server is an authentication-only server (no authorization or accounting). Only RADIUS servers are supported for 802.1X Port-based Network Access Control.

The following table describes how each type of server can be used with the switch:

Server Type	Authenticated Switch Access	Authenticated VLANs	802.1X Port-Based Network Access Control
ACE/Server	yes (except SNMP)	no	no
RADIUS	yes (except SNMP)	yes	yes
TACACS+	yes (including SNMP)	yes	no
LDAP	yes (including SNMP)	yes	no

Backup Authentication Servers

Each RADIUS, TACACS+, and LDAP server can have one backup host (of the same type) configured through the [aaa radius-server](#), [aaa tacacs+-server](#), and [aaa ldap-server](#) commands, respectively. In addition, each authentication method (Authenticated Switch Access, Authenticated VLANs, or 802.1X) can specify a list of backup authentication servers that includes servers of different types (if supported on the feature).

The switch uses the first available authentication server to attempt to authenticate users. If user information is not found on the first available server, the authentication attempts fails.

Authenticated Switch Access

When RADIUS, TACACS+, and/or LDAP servers are set up for Authenticated Switch Access, the switch polls the server for user login information. The switch also polls the server for privilege information (authorization) if it has been configured on the server; otherwise, the local user database is polled for the privileges.

For RADIUS, TACACS+, and LDAP, additional servers can be configured as backups.

A RADIUS server supporting the challenge and response mechanism as defined in RADIUS RFC 2865 can access an ACE/Server for authentication purposes. The ACE/Server is then used for user authentication, and the RADIUS server is used for user authorization.

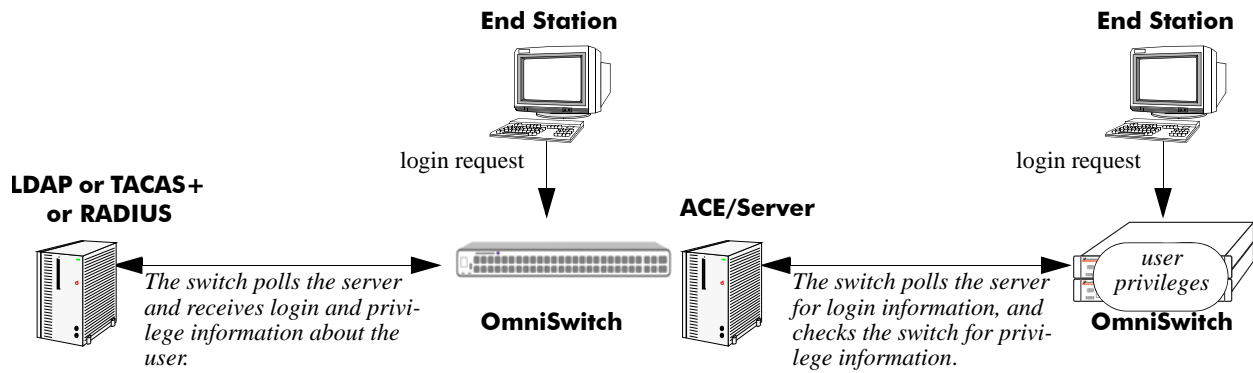

Servers Used for Authenticated Switch

RADIUS Servers

RADIUS is a standard authentication and accounting protocol defined in RFC 2865 and RFC 2866. A built-in RADIUS client is available in the switch. A RADIUS server that supports Vendor Specific Attributes (VSAs) is required. The Alcatel-Lucent attributes can include VLAN information, time-of-day, or slot/port restrictions.

RADIUS Server Attributes

RADIUS servers and RADIUS accounting servers are configured with particular attributes defined in RFC 2138 and RFC 2139, respectively. These attributes carry specific authentication, authorization, and configuration details about RADIUS requests to and replies from the server. This section describes the attributes and how to configure them on the server.

Standard Attributes

The following tables list RADIUS server attributes 1–39 and 60–63, their descriptions, and whether the Alcatel-Lucent RADIUS client in the switch supports them. Attribute 26 is for vendor-specific information and is discussed in [“Vendor-Specific Attributes for RADIUS” on page 29-9](#). Attributes 40–59 are used for RADIUS accounting servers and are listed in [“RADIUS Accounting Server Attributes” on page 29-10](#).

Num.	Standard Attribute	Notes
1	User-Name	Used in access-request and account-request packets.
2	User-Password	—
3	CHAP-Password	<i>Not supported.</i>
4	NAS-IP-Address	Sent with every access-request. Specifies which switches a user can have access to. More than one of these attributes is allowed per user.
5	NAS-Port	Virtual port number sent with access-request and account-request packets. Slot/port information is supplied in attribute 26 (vendor-specific).
6	Service-Type	Framed-User (2) if authentication request type is: <ul style="list-style-type: none"> - supplicant/802.1x authentication - captive-portal authentication - ASA authentication Call-Check (10) if authentication request type is: <ul style="list-style-type: none"> - MAC based authentication

Num.	Standard Attribute	Notes
7	Framed-Protocol	<i>Not supported. These attributes are used for dial-up sessions; not applicable to the RADIUS client in the switch.</i>
8	Framed-IP-Address	
9	Framed-IP-Netmask	
10	Framed-Routing	
11	Filter-Id	
12	Framed-MTU	
13	Framed-Compression	
14	Login-IP-Host	<i>Not supported. These attributes are used for dial-up sessions; not applicable to the RADIUS client in the switch.</i>
15	Login-Service	
16	Login-TCP-Port	
17	Unassigned	
18	Reply-Message	Multiple reply messages are supported, but the length of all the reply messages returned in one access-accept or access-reject packet cannot exceed 256 characters.
19	Callback-Number	<i>Not supported. These attributes are used for dial-up sessions; not applicable to the RADIUS client in the switch.</i>
20	Callback-Id	
21	Unassigned	
22	Frame-Route	
23	Framed-IPX-Network	
24	State	Sent in challenge/response packets.
25	Class	Used to pass information from the server to the client and passed unchanged to the accounting server as part of the accounting-request packet.
26	Vendor-Specific	See “Vendor-Specific Attributes for RADIUS” on page 29-9.
27	Session-Timeout	<i>Not supported.</i>
28	Idle-Timeout	<i>Not supported.</i>
29	Termination-Action	<i>Not supported. These attributes are used for dial-up sessions; not applicable to the RADIUS client in the switch.</i>
30	Called-Station-Id	
31	Calling-Station-Id	
32	NAS-Identifier	
33	Proxy-State	
34	Login-LAT-Service	
35	Login-LAT-Node	
36	Login-LAT-Group	
37	Framed-AppleTalk-Link	
38	Framed-AppleTalk-Network	
39	Framed-AppleTalk-Zone	
60	CHAP-Challenge	
61	NAS-Port-Type	
62	Port-Limit	
63	Login-LAT-Port	

Vendor-Specific Attributes for RADIUS

The Alcatel-Lucent RADIUS client supports attribute 26, which includes a vendor ID and some additional sub-attributes called subtypes. The vendor ID and the subtypes collectively are called Vendor Specific Attributes (VSAs). Alcatel-Lucent, through partnering arrangements, has included these VSAs in some vendors' RADIUS server configurations.

The attribute subtypes are defined in the dictionary file of the server. If you are using single authority mode, the first VSA subtype, Alcatel-Lucent-Auth-Vlan, must be defined on the server for each authenticated VLAN. Alcatel-Lucent's vendor ID is 800 (SMI Network Management Private Enterprise Code).

The following are VSAs for RADIUS servers:

Num.	RADIUS VSA	Type	Description
1	Alcatel-Lucent-Auth-Group	integer	The authenticated VLAN number. The only protocol associated with this attribute is Ethernet II. If other protocols are required, use the protocol attribute instead.
2	Alcatel-Lucent-Slot-Port	string	Slot(s)/port(s) valid for the user.
3	Alcatel-Lucent-Time-of-Day	string	The time of day valid for the user to authenticate.
4	Alcatel-Lucent-Client-IP-Addr	address	The IP address used for Telnet only.
5	Alcatel-Lucent-Group-Desc	string	Description of the authenticated VLAN.
6	Alcatel-Lucent-Port-Desc	string	Description of the port.
8	Alcatel-Lucent-Auth-Group-Protocol	string	The protocol associated with the VLAN. must be configured for access to other protocols. Values include: IP_E2 , IP_SNAP , IPX_E2 , IPX_NOV , IPX_LLC , IPX_SNAP .
9	Alcatel-Lucent-Asa-Access	string	Specifies that the user has access to the switch. The only valid value is all .
39	Alcatel-Lucent-Acce-Priv-F-R1	hex.	Configures functional read privileges for the user.
40	Alcatel-Lucent-Acce-Priv-F-R2	hex.	Configures functional read privileges for the user.
41	Alcatel-Lucent-Acce-Priv-F-W1	hex.	Configures functional write privileges for the user.
42	Alcatel-Lucent-Acce-Priv-F-W2	hex.	Configures functional write privileges for the user.

The Alcatel-Lucent-Auth-Group attribute is used for Ethernet II only. If a different protocol, or more than one protocol is required, use the Alcatel-Lucent-Auth-Group-Protocol attribute instead. For example:

```
Alcatel-Lucent-Auth-Group-Protocol 23: IP_E2 IP_SNAP
Alcatel-Lucent-Auth-Group-Protocol 24: IPX_E2
```

In this example, authenticated users on VLAN 23 can use Ethernet II or SNAP encapsulation. Authenticated users on VLAN 24 can use IPX with Ethernet II.

RADIUS Accounting Server Attributes

The following table lists the standard attributes supported for RADIUS accounting servers. The attributes in the **radius.ini** file can be modified if necessary.

Num.	Standard Attribute	Description
1	User-Name	Used in access-request and account-request packets.
4	NAS-IP-Address	Sent with every access-request. Specifies which switches a user can have access to. More than one of these attributes is allowed per user.
5	NAS-Port	Virtual port number sent with access-request and account-request packets. Slot/port information is supplied in attribute 26 (vendor-specific).
25	Class	Used to pass information from the server to the client and passed unchanged to the accounting server as part of the accounting-request packet.
40	Acct-Status-Type	Four values must be included in the dictionary file: 1 (acct-start), 2 (acct-stop), 6 (failure), and 7 (acct-on). Start and stop correspond to login/logout. The accounting-on message is sent when the RADIUS client is started. This attribute also includes an accounting-off value, which is not supported.
42	Acct-Input-Octets	(Authenticated VLANs only) Tracked per port.
43	Acct-Output-Octets	(Authenticated VLANs only) Tracked per port.
44	Acct-Session	Unique accounting ID. (For authenticated VLAN users, Alcatel-Lucent uses the MAC address of the client.)
45	Acct-Authentic	Indicates how the client is authenticated; standard values (1–3) are not used. Vendor specific values must be used instead: AUTH-AVCLIENT (4) AUTH-TELNET (5) AUTH-HTTP (6) AUTH-NONE (0)
46	Acct-Session	The start and stop time for a user session can be determined from the accounting log.
47	Acct-Input-Packets	(Authenticated VLANs only) Tracked per port.
48	Acct-Output-Packets	(Authenticated VLANs only) Tracked per port.
49	Acct-Terminal-Cause	Indicates how the session was terminated: NAS-ERROR USER-ERROR LOST CARRIER USER-REQUEST STATUS-FAIL

The following table lists the VSAs supported for RADIUS accounting servers. The attributes in the **radius.ini** file can be modified if necessary.

Num.	Accounting VSA	Type	Description
1	Alcatel-Lucent-Auth-Group	integer	The authenticated VLAN number. The only protocol associated with this attribute is Ethernet II. If other protocols are required, use the protocol attribute instead.
2	Alcatel-Lucent-Slot-Port	string	Slot(s)/port(s) valid for the user.
4	Alcatel-Lucent-Client-IP-Addr	dotted decimal	The IP address used for Telnet only.
5	Alcatel-Lucent-Group-Desc	string	Description of the authenticated VLAN.

Configuring the RADIUS Client

Use the **aaa radius-server** command to configure RADIUS parameters on the switch.

RADIUS server keywords

key	timeout
host	auth-port
retransmit	acct-port

When creating a new server, at least one host name or IP address (specified by the **host** keyword) is required as well as the shared secret (specified by the **key** keyword).

In this example, the server name is **rad1**, the host address is 10.10.2.1, the backup address is 10.10.3.5, and the shared secret is **amadeus**. Note that the shared secret must be configured exactly the same as on the server.

```
-> aaa radius-server rad1 host 10.10.2.1 10.10.3.5 key amadeus
```

To modify a RADIUS server, enter the server name and the desired parameter to be modified.

```
-> aaa radius-server rad1 key mozart
```

If you are modifying the server and have just entered the **aaa radius-server** command to create or modify the server, you can use command prefix recognition. For example:

```
-> aaa radius-server rad1 retransmit 5
-> timeout 5
```

For information about server defaults, see [“Server Defaults” on page 29-3](#).

To remove a RADIUS server, use the **no** form of the command:

```
-> no aaa radius-server rad1
```

Note that only one server can be deleted at a time.

TACACS+ Server

Terminal Access Controller Access Control System (TACACS+) is a standard authentication and accounting protocol defined in RFC 1321 that employs TCP for reliable transport. A built-in TACACS+ client is available in the switch. A TACACS+ server allows access control for routers, network access servers, and other networked devices through one or more centralized servers. The protocol also allows separate authentication, authorization, and accounting services. By allowing arbitrary length and content authentication exchanges, it allows clients to use any authentication mechanism.

The TACACS+ client offers the ability to configure multiple TACACS+ servers. This can be done by the user. When the primary server fails, the client tries the subsequent servers. Multiple server configurations are applicable only for backup and not for server chaining.

In the TACACS+ protocol, the client queries the TACACS+ server by sending TACACS+ requests. The server responds with reply packets indicating the status of the request.

- **Authentication.** TACACS+ protocol provides authentication between the client and the server. It also ensures confidentiality because all the exchanges are encrypted. The protocol supports fixed passwords, one-time passwords, and challenge-response queries. Authentication is not a mandatory feature, and it can be enabled without authorization and accounting. During authentication if a user is not found on the primary TACACS+ server, the authentication fails. The client does not try to authenticate with the other servers in a multiple server configuration. If the authentication succeeds, then Authorization is performed.
- **Authorization.** Enabling authorization determines if the user has the authority to execute a specified command. TACACS+ authorization cannot be enabled independently. The TACACS+ authorization is enabled automatically when the TACACS+ authentication is enabled.
- **Accounting.** The process of recording what the user is attempting to do or what the user has done is Accounting. The TACACS+ accounting must be enabled on the switches for accounting to succeed. Accounting can be enabled irrespective of authentication and authorization. TACACS+ supports three types of accounting:

Start Records—Indicate the service is about to begin.

Stop Records—Indicates the services has just terminated.

Update Records—Indicates the services are still being performed.

TACACS+ Client Limitations

The following limitation apply to this implementation of the TACACS+ client application:

- TACACS+ supports Authenticated Switch Access and cannot be used for user authentication.
- Authentication and Authorization are combined together and cannot be performed independently.
- On the fly, command authorization is not supported. Authorization is similar to the AOS partition management families.
- Only inbound ASCII logins are supported.
- A maximum of 50 simultaneous TACACS+ sessions can be supported when no other authentication mechanism is activated.
- Accounting of commands performed by the user on the remote TACACS+ process is not supported in the **boot.cfg** file at boot up time.

Configuring the TACACS+ Client

Use the `aaa tacacs+-server` command to configure TACACS+ parameters on the switch.

TACACS+ server keywords

key	timeout
host	port

When creating a new server, at least one host name or IP address (specified by the **host** keyword) is required as well as the shared secret (specified by the **key** keyword).

In this example, the server name is **tacl**, the host address is 10.10.5.2, the backup address is 10.10.5.5, and the shared secret is **otna**. Note that the shared secret must be configured exactly the same as on the server.

```
-> aaa tacacs+-server tacl host 10.10.5.2 10.10.5.5 key otna
```

To modify a TACACS+ server, enter the server name and the desired parameter to be modified.

```
-> aaa tacacs+-server tacl key tnmelc
```

If you are modifying the server and have just entered the `aaa tacacs+-server` command to create or modify the server, you can use command prefix recognition. For example:

```
-> aaa tacacs+-server tacl timeout 5
```

For information about server defaults, see [“Server Defaults” on page 29-3](#).

To remove a TACACS+ server, use the **no** form of the command:

```
-> no aaa tacacs+-server tacl
```

Note that only one server can be deleted at a time.

LDAP Servers

Lightweight Directory Access Protocol (LDAP) is a standard directory server protocol. The LDAP client in the switch is based on several RFCs: 1798, 2247, 2251, 2252, 2253, 2254, 2255, and 2256. The protocol was developed as a way to use directory services over TCP/IP and to simplify the directory access protocol (DAP) defined as part of the Open Systems Interconnection (OSI) effort. Originally it was a front-end for X.500 DAP.

The protocol synchronizes and governs the communications between the LDAP client and the LDAP server. The protocol also dictates how its databases of information, which are normally stored in hierarchical form, are searched, from the root directory down to distinct entries.

In addition, LDAP has its own format that permits LDAP-enabled Web browsers to perform directory searches over TCP/IP.

Setting Up the LDAP Authentication Server

- 1 Install the directory server software on the server.
- 2 Copy the relevant schema LDIF files from the Alcatel-Lucent software CD to the configuration directory on the server. (Each server type has a command line tool or a GUI tool for importing LDIF files.) Database LDIF files can also be copied and used as templates. The schema files and the database files are specific to the server type. The files available on the Alcatel-Lucent software CD include the following:

```
aaa_schema.microsoft.ldif
aaa_schema.netscape.ldif
aaa_schema.novell.ldif
aaa_schema.openldap.schema
aaa_schema.sun.ldif

aaa_database.microsoft.ldif
aaa_database.netscape.ldif
aaa_database.novell.ldif
aaa_database.openldap.ldif
aaa_database.sun.ldif
```

- 3 After the server files have been imported, restart the server.

Note. Schema checking must be enabled on the server.

Information in the server files must match information configured on the switch through the **aaa ldap-server** command. For example, the port number configured on the server must be the same as the port number configured on the switch. See [“Configuring the LDAP Authentication Client” on page 29-25](#) for information about using this command.

LDAP Server Details

LDAP servers must be configured with the properly defined LDAP schema and correct database suffix, including well-populated data. LDAP schema is extensible, permitting entry of user-defined schema as needed.

LDAP servers are also able to import and export directory databases using LDIF (LDAP Data Interchange Format).

LDIF File Structure

LDIF is used to transfer data to LDAP servers in order to build directories or modify LDAP databases. LDIF files specify multiple directory entries or changes to multiple entries, but not both. The file is in simple text format and can be created or modified in any text editor. In addition, LDIF files import and export binary data encoded according to the base 64 convention used with MIME (Multipurpose Internet Mail Extensions) to send various media file types, such as JPEG graphics, through electronic mail.

An LDIF file entry used to define an organizational unit would look like this:

```
dn: <distinguished name>
objectClass: top
objectClass: organizationalUnit
ou: <organizational unit name>
<list of optional attributes>
```

Below are definitions of some LDIF file entries:

entries	definition
dn: <distinguished name>	Defines the DN (required).
objectClass: top	Defines top object class (at least one is required). Object class defines the list of attributes required and allowed in directory server entries.
objectClass: organizationalUnit	Specifies that organizational unit must be part of the object class.
ou: <organizationalUnit name>	Defines the name of the organizational unit.
<list of attritbutes>	Defines the list of optional entry attributes.

Common Entries

The most common LDIF entries describe people in companies and organizations. The structure for such an entry might look like the following:

```
dn: <distinguished name>
objectClass: top
objectClass: person
objectClass: organizational Person
cn: <common name>
sn: <surname>
<list of optional attributes>
```

This is how the entry would appear with actual data in it.

```
dn: uid=yname, ou=people, o=yourcompany  
objectClass: top  
objectClass: person  
objectClass: organizational Person  
cn: your name  
sn: last name  
givenname: first name  
uid: yname  
ou: people  
description:  
<list of optional attributes>  
...
```

Directory Entries

Directory entries are used to store data in directory servers. LDAP-enabled directory entries contain information about an object (person, place, or thing) in the form of a Distinguished Name (DN) that must be created in compliance with the LDAP protocol naming conventions.

Distinguished names are constructed from Relative Distinguished Names (RDNs), related entries that share no more than one attribute value with a DN. RDNs are the components of DNs, and DNs are string representations of entry names in directory servers.

Distinguished names typically consist of descriptive information about the entries they name, and frequently include the full names of individuals in a network, their email addresses, TCP/IP addresses, with related attributes such as a department name, used to further distinguish the DN. Entries include one or more object classes, and often a number of attributes that are defined by values.

Object classes define all required and optional attributes (a set of object classes is referred to as a “schema”). As a minimum, every entry must include the DN and one defined object class, like the name of an organization. Attributes required by a particular object class must also be defined. Some commonly used attributes that comprise a DN include the following:

**Country (c), State or Province (st), Locality (l),
Organization (o), Organization Unit (ou),
and Common Name (cn)**

Although each attribute would necessarily have its own values, the attribute syntax determines what kind of values are allowed for a particular attribute, for example, (c=US), where country is the attribute and US is the value. Extra consideration for attribute language codes is required if entries are made in more than one language.

Entries are usually based on physical locations and established policies in a Directory Information Tree (DIT); the DN locates an entry in the hierarchy of the tree. Alias entries pointing to other entries can also be used to circumvent the hierarchy during searches for entries.

Once a directory is set up, DN attributes must thereafter be specified in the same order to keep the directory paths consistent. DN attributes are separated by commas as shown in this example:

cn=your name, ou=your function, o= your company, c=US

As there are other conventions used, please refer to the appropriate RFC specification for further details.

In addition to managing attributes in directory entries, LDAP makes the descriptive information stored in the entries accessible to other applications. The general structure of entries in a directory tree is shown in the following illustration. It also includes example entries at various branches in the tree.

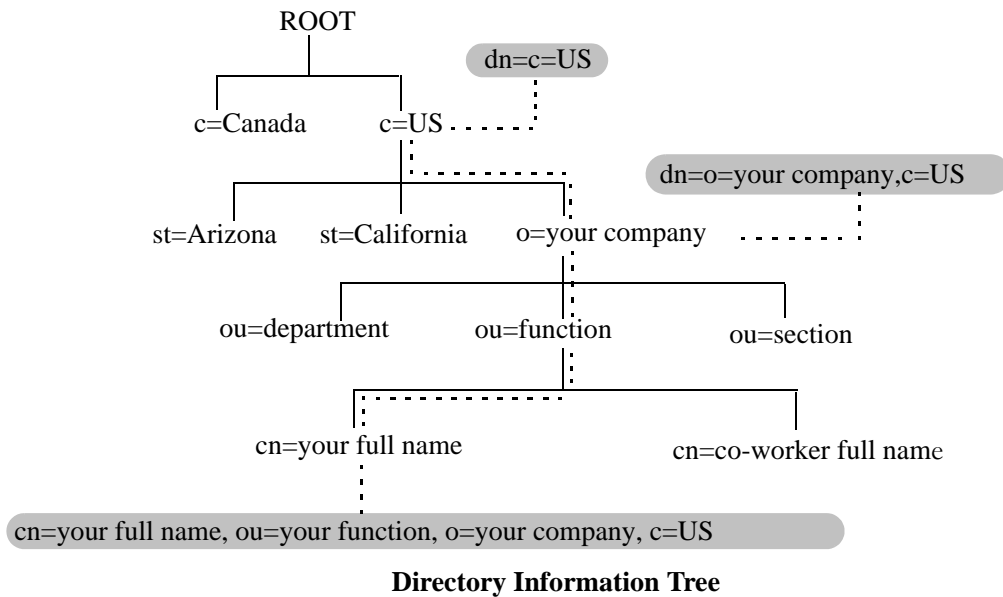

Directory Searches

DNs are always the starting point for searches unless indicated otherwise in the directory schema.

Searches involve the use of various criteria including scopes and filters which must be predefined, and utility routines, such as Sort. Searches must be limited in scope to specific durations and areas of the directory. Some other parameters used to control LDAP searches include the size of the search and whether to include attributes associated with name searches.

Base objects and scopes are specified in the searches, and indicate where to search in the directory. Filters are used to specify entries to select in a given scope. The filters are used to test the existence of object class attributes, and enable LDAP to emulate a “read” of entry listings during the searches. All search preferences are implemented by means of a filter in the search. Filtered searches are based on some component of the DN.

Retrieving Directory Search Results

Results of directory searches are individually delivered to the LDAP client. LDAP referrals to other servers are not returned to the LDAP client, only results or errors. If referrals are issued, the server is responsible for them, although the LDAP client retrieves results of asynchronous operations.

Directory Modifications

Modifications to directory entries contain changes to DN entry attribute values, and are submitted to the server by an LDAP client application. The LDAP-enabled directory server uses the DNs to find the entries to either add or modify their attribute values.

Attributes are automatically created for requests to add values if the attributes are not already contained in the entries.

All attributes are automatically deleted when requests to delete the last value of an attribute are submitted. Attributes can also be deleted by specifying delete value operations without attaching any values.

Modified attribute values are replaced with other given values by submitting replace requests to the server, which then translates and performs the requests.

Directory Compare and Sort

LDAP compares directory entries with given attribute values to find the information it needs. The Compare function in LDAP uses a DN as the identity of an entry, and searches the directory with the type and value of an attribute. Compare is similar to the Search function, but simpler.

LDAP also sorts entries by their types and attributes. For the Sort function, there are essentially two methods of sorting through directory entries. One is to sort by entries where the DN (Distinguished Name) is the sort key. The other is to sort by attributes with multiple values.

The LDAP URL

LDAP URLs are used to send search requests to directory servers over TCP/IP on the internet, using the protocol prefix: **ldap://**. (Searches over SSL would use the same prefix with an “s” at the end, i.e., **ldaps://**.)

LDAP URLs are entered in the command line of any web browser, just as HTTP or FTP URLs are entered. When LDAP searches are initiated LDAP checks the validity of the LDAP URLs, parsing the various components contained within the URLs to process the searches. LDAP URLs can specify and implement complex or simple searches of a directory depending on what is submitted in the URLs. Searches performed directly with LDAP URLs are affected by the LDAP session parameters described above.

In the case of multiple directory servers, LDAP URLs are also used for referrals to other directory servers when a particular directory server does not contain any portion of requested IP address information. Search requests generated through LDAP URLs are not authenticated.

Searches are based on entries for attribute data pairs.

The syntax for TCP/IP LDAP URLs is as follows:

ldap://<hostname>:<port>/<base_dn>?attributes?<scope>?<filter>

An example might be:

ldap://ldap.company name.xxx/o=company name%inc./,c=US>
(base search including all attributes/object classes in scope).

LDAP URLs use the percent symbol to represent commas in the DN. The following table shows the basic components of LDAP URLs.

components	description
<ldap>	Specifies TCP/IP connection for LDAP protocol. (The <ldaps> prefix specifies SSL connection for LDAP protocol.)
<hostname>	Host name of directory server or computer, or its IP address (in dotted decimal format).
<port>	TCP/IP port number for directory server. If using TCP/IP and default port number (389), port need not be specified in the URL. SSL port number for directory server (default is 636).

components	description
<base_dn>	DN of directory entry where search is initiated.
<attributes>	Attributes to be returned for entry search results. All attributes are returned if search attributes are not specified.
<scope>	Different results are retrieved depending on the scopes associated with entry searches. “base” search: retrieves information about distinguished name as specified in URL. This is a <base_dn> search. Base searches are assumed when the scope is not designated. “one” (one-level) search: retrieves information about entries one level under distinguished name (<base_dn> as specified in the URL, excluding the base entry. “sub” (subtree) search: retrieves information about entries from all levels under the distinguished name (<base_dn>) as specified in the URL, including the base entry.
<filter>	Search filters are applied to entries within specified search scopes. Default filter objectClass=* is used when filters are not designated. (Automatic search filtering not yet available.)

Password Policies and Directory Servers

Password policies applied to user accounts vary slightly from one directory server to another. Normally, only the password changing policies can be set by users through the directory server graphical user interface (GUI). Other policies accessible only to Network Administrators through the directory server GUI can include one or more of the following operational parameters.

- Log-in Restrictions
- Change Password
- Check Password Syntax
- Password Minimum Length
- Send Expiration Warnings
- Password History
- Account Lockout
- Reset Password Failure Count
- LDAP Error Messages (for example, Invalid Username/Password, Server Data Error, etc.)

For instructions on installing LDAP-enabled directory servers, refer to the vendor-specific instructions.

Directory Server Schema for LDAP Authentication

Object classes and attributes need to be modified accordingly to include LDAP authentication in the network (object classes and attributes are used specifically here to map user account information contained in the directory servers).

- All LDAP-enabled directory servers require entry of an auxiliary objectClass:passwordObject for user password policy information.
- Another auxiliary objectClass: password policy is used by the directory server to apply the password policy for the entire server. There is only one entry of this object for the database server.

Note. Server schema extensions must be configured before the **aaa ldap-server** command is configured.

Vendor-Specific Attributes for LDAP Servers

The following are Vendor Specific Attributes (VSAs) for Authenticated Switch Access and/or Layer 2 Authentication:

attribute	description
bop-asa-func-priv-read-1	Read privileges for the user.
bop-asa-func-priv-read-2	Read privileges for the user.
bop-asa-func-priv-write-1	Write privileges for the user.
bop-asa-func-priv-write-2	Write privileges for the user.
bop-asa-allowed-access	Whether the user has access to configure the switch.
bop-asa-snmp-level-security	Whether the user can have SNMP access, and the type of SNMP protocol used.
bop-shakey	A key computed from the user password with the alp2key tool.
bop-md5key	A key computed from the user password with the alp2key tool.
allowedtime	The periods of time the user is allowed to log into the switch.
switchgroups	The VLAN ID and protocol (IP_E2 , IP_SNAP , IPX-E2 , IPX_NOV , IPX_LLC , IPX_SNAP).

Setting the SNMP Security Level

Use the table below to set the appropriate **bop-asa-snmp-level-security** attribute.

Level	LDAP snmp-level-security	Definition
no	1	No SNMP access allowed
no auth	2	SNMP access allowed without any SNMP authentication and encryption
sha	3	SHA authentication algorithm needed for authenticating SNMP
md5	4	MD5 authentication algorithm needed for authenticating SNMP
sha+des	5	SHA authentication algorithm and DES encryption needed for authentication SNMP
md5+des	6	MD5 authentication algorithm and DES encryption needed for authentication SNMP

Configuring Functional Privileges on the Server

Configuring the functional privileges attributes (**bop-asa-func-priv-read-1**, **bop-asa-func-priv-read-2**, **bop-asa-func-priv-write-1**, **bop-asa-func-priv-write-2**) requires using read and write bitmasks for command families on the switch.

- 1 To display the functional bitmasks of the desired command families, use the **show aaa priv hexa** command.
- 2 On the LDAP server, configure the functional privilege attributes with the bitmask values.

For more information about configuring users on the switch, see the Switch Security chapter of the *OmniSwitch AOS Release 8 Switch Management Guide*.

Configuring Authentication Key Attributes

The alp2key tool is provided on the Alcatel-Lucent software CD for computing SNMP authentication keys. The alp2key application is supplied in two versions, one for Unix (Solaris 2.5.1 or higher) and one for Windows (NT 4.0 and higher).

To configure the bop-shakey or bop-md5key attributes on the server:

- 1 Use the alp2key application to calculate the authentication key from the password of the user. The switch automatically computes the authentication key, but for security reasons the key is never displayed in the CLI.
- 2 Cut and paste the key to the relevant attribute on the server.

An example using the alp2key tool to compute the SHA and MD5 keys for **mypassword**:

```
ors40595{}128: alp2key mypassword
bop-shakey: 0xb1112e3472ae836ec2b4d3f453023b9853d9d07c
bop-md5key: 0xeb3ad6ba929441a0ff64083d021c07f1
ors40595{}129:
```

Note. The bop-shakey and bop-md5key values must be recomputed and copied to the server any time a user password is changed.

LDAP Accounting Attributes

Logging and accounting features include Account Start, Stop and Fail Times, and Dynamic Log. Typically, the Login and Logout logs can be accessed from the directory server software. Additional third-party software is required to retrieve and reset the log information to the directory servers for billing purposes.

The following sections describe accounting server attributes.

AccountStartTime

User account start times are tracked in the AccountStartTime attribute of the directory entry of the user that keeps the time stamp and accounting information of user log-ins. The following fields (separated by carriage returns “\n”) are contained in the Login log. Some fields are only used for Layer 2 Authentication.

Fields Included For Any Type of Authentication

- User account ID or username client entered to log-in: variable length digits.
- Time Stamp (YYYYMMDDHHMMSS (YYYY:year, MM:month, DD:day, HH:hour, MM:minute, SS:second))
- Switch serial number: Alcatel-Lucent.BOP.<switch name>.<MAC address>
- Client IP address: variable length digits.

Fields Included for Layer 2 Authentication Only

- Client MAC address: xx:xx:xx:xx:xx:xx:xx (alphanumeric).
- Switch VLAN number client joins in multiple authority mode (0=single authority; 2=multiple authority); variable-length digits.
- Switch slot number to which client connects: nn
- Switch port number to which client connects: nn
- Switch virtual interface to which client connects: nn

AccountStopTime

User account stop times are tracked in the AccountStopTime attribute that keeps the time stamp and accounting information of successful user log-outs. The same fields as above (separated by carriage returns “\n”) are contained in the Logout log. A different carriage return such as the # sign can be used in some situations. Additionally, these fields are included but apply only to the Logout log:

Fields For Any Type of Authentication

- Log-out reason code, for example LOGOFF(18) or DISCONNECTED BY ADMIN(19)
- User account ID or username client entered to log-in: variable length digits.

Fields For Layer 2 Authentication Only

- Number of bytes received on the port during the client session from log-in to log-out: variable length digits.
- Number of bytes sent on the port during the client session from log-in to log-out: variable length digits.
- Number of frames received on the port during the client session from log-in to log-out: variable length digits.
- Number of frames sent on the port during the client session from log-in to log-out: variable length digits.

AccountFailTime

The AccountFailTime attribute log records the time stamp and accounting information of unsuccessful user log-ins. The same fields in the Login Log—which are also part of the Logout log (separated by carriage returns “[”)—are contained in the Login Fail log. A different carriage return such as the # sign can be used in some situations. Additionally, these fields are included but apply only to the Login Fail log.

- User account ID or username client entered to log-in: variable length digits.
- Log-in fail error code: nn. For error code descriptions refer to the vendor-specific listing for the specific directory server in use.
- Log-out reason code, for example PASSWORD EXPIRED(7) or AUTHENTICATION FAILURE(21).

Dynamic Logging

Dynamic logging can be performed by an LDAP-enabled directory server if an LDAP server is configured **first** in the list of authentication servers configured through the **aaa accounting session** command. Any other servers configured are used for accounting (storing history records) only. For example:

```
-> aaa accounting session ldap2 rad1 rad2
```

In this example, server **ldap2** is used for dynamic logging, and servers **rad1** and **rad2** is used for accounting.

If you specify a RADIUS server first, all of the servers specified is used for recording history records (not logging). For example:

```
-> aaa accounting session rad1 ldap2
```

In this example, both the **rad1** and **ldap2** servers is used for history only. Dynamic logging does not take place on the LDAP server.

Dynamic entries are stored in the LDAP-enabled directory server database from the time the user successfully logs in until the user logs out. The entries are removed when the user logs out.

- Entries are associated with the switch the user is logged into.
- Each dynamic entry contains information about the user connection. The related attribute in the server is bop-loggedusers.

A specific object class called **alcatelBopSwitchLogging** contains three attributes as follows:

Attribute	Description
bop-basemac	MAC range, which uniquely identifies the switch.
bop-switchname	Host name of the switch.
bop-loggedusers	Current activity records for every user logged onto the switch identified by bop-basemac.

Each switch that is connected to the LDAP-enabled directory server has a DN starting with bop-basemac-xxxxx, ou=bop-logging. If the organizational unit ou=bop.logging exists somewhere in the tree under searchbase, logging records are written on the server. See the documentation of the server manufacturer for more information about setting up the server.

The bop-loggedusers attribute is a formatted string with the following syntax:

loggingMode : accessType ipAddress port macAddress vlanList userName

The fields are defined here:

Field	Possible Values
loggingMode	ASA <i>x</i> —for an authenticated user session, where <i>x</i> is the number of the session AVLAN —for Authenticated VLAN session in single authority mode AVLAN <i>y</i> —for Authenticated VLAN session in multiple authority mode, where <i>y</i> is relevant VLAN
accessType	Any one of the following: CONSOLE, MODEM, TELNET, HTTP, FTP, XCAP
ipAddress	The string IP followed by the IP address of the user.
port	(For Authenticated VLAN users only.) The string PORT followed by the slot/port number.
macAddress	(For Authenticated VLAN users only.) The string MAC followed by the MAC address of the user.
vlanList	(For Authenticated VLAN users only.) The string VLAN followed by the list of VLANs the user is authorized (for single-mode authority).
userName	The login name of the user.

For example:

```
"ASA      0      :  CONSOLE IP 65.97.233.108  Jones"
```

Configuring the LDAP Authentication Client

Use the `aaa ldap-server` command to configure LDAP authentication parameters on the switch. The server name, host name or IP address, distinguished name, password, and the search base name are required for setting up the server. Optionally, a backup host name or IP address can be configured, as well as the number of retransmit tries, the timeout for authentication requests, and whether or not a secure Socket Layer (SSL) is enabled between the switch and the server.

Note. The server must be configured with the appropriate schema before the `aaa ldap-server` command is configured.

The keywords for the `aaa ldap-server` command are listed here:

Required for creating:	optional:
host	type
dn	retransmit
password	timeout
base	port
	ssl

Creating an LDAP Authentication Server

An example of creating an LDAP server:

```
-> aaa ldap-server ldap2 host 10.10.3.4 dn cn=manager password tpub base c=us
```

In this example, the switch can communicate with an LDAP server (called **ldap2**) that has an IP address of 10.10.3.4, a domain name of cn=manager, a password of tpub, and a searchbase of c=us. These parameters must match the same parameters configured on the server itself.

Note. The distinguished name must be different from the searchbase name.

Modifying an LDAP Authentication Server

To modify an LDAP authentication server, use the `aaa ldap-server` command with the server name; or, if you have just entered the `aaa ldap-server` command to create or modify the server, you can use command prefix recognition. For example:

```
-> aaa ldap-server ldap2 password my_pass
-> timeout 4
```

In this example, an existing LDAP server is modified with a different password, and then the timeout is modified on a separate line. These two command lines are equivalent to:

```
-> aaa ldap-server ldap2 password my_pass timeout 4
```

Setting Up SSL for an LDAP Authentication Server

A Secure Socket Layer (SSL) can be set up on the server for additional security. When SSL is enabled, the server identity is authenticated. The authentication requires a certificate from a Certification Authority (CA). If the CA providing the certificate is well-known, the certificate is automatically extracted from the **Kbase.img** file on the switch (**certs.pem**). If the CA is not well-known, the CA certificate must be

transferred to the switch through FTP to the /flash/certified or /flash/working directory and must be named **optcerts.pem**. The switch merges either or both of these files into a file called **ldapcerts.pem**.

To set up SSL on the server, specify **ssl** with the **aaa ldap-server** command:

```
-> aaa ldap-server ldap2 ssl
```

The switch automatically sets the port number to 636 when SSL is enabled. The 636 port number is typically used on LDAP servers for SSL. The port number on the switch must match the port number configured on the server. If the port number on the server is different from the default, use the **aaa ldap-server** command with the **port** keyword to configure the port number. For example, if the server port number is 635, enter the following:

```
-> aaa ldap-server ldap2 port 635
```

The switch can now communicate with the server on port 635.

To remove SSL from the server, use **no** with the **ssl** keyword. For example:

```
-> aaa ldap-server ldap2 no ssl
```

SSL is now disabled for the server.

Removing an LDAP Authentication Server

To delete an LDAP server from the switch configuration, use the **no** form of the command with the relevant server name.

```
-> no aaa ldap-server topanga5
```

The topanga5 server is removed from the configuration.

Verifying the Authentication Server Configuration

To display information about authentication servers, use the following command:

show aaa server Displays information about a particular AAA server or AAA servers.

An example of the output for this command is given in [“Quick Steps For Configuring Authentication Servers” on page 29-4](#). For more information about the output of this command, see the *OmniSwitch CLI Reference Guide*.

30 Configuring Universal Network Profiles

The Universal Network Profile (UNP) feature provides network administrators with the ability to define and apply network access control to specific types of devices by grouping such devices according to specific matching profile criteria. This allows network administrators to create virtual machine network profiles (vNPs) *and* user network profiles from a unified framework of operation and administration.

UNP is not limited to creating profiles for only certain types of devices. However, the following classification methods implemented through UNP functionality and profile criteria provide the ability to tailor profiles for specific devices (physical or virtual):

- MAC-based and 802.1X-based authentication using a RADIUS-capable server.
- Redirection for Captive Portal authentication.
- Redirection to ClearPass Policy Manager (CPPM) for Bring Your Own Devices (BYOD) user device registration, integrity check, UNP assignment, and policy list assignment.
- Switch-wide classification rules to classify users based on port and device attributes (for example, source MAC, Group ID, IP address). No authentication required.
- VLAN tag classification to create VLAN port or Service Access Point (SAP) associations based on the VLAN ID contained in device packets.
- Default UNP classification for traffic not classified through other methods.

Basically, UNP functionality is used to define profile-based VLANs or Shortest Path Bridging (SPB) services to which network devices are assigned. The profile can allow, deny, or require actions by users or machines on the network. Because membership to a VLAN or service is based on UNP profile criteria, devices assigned to the VLAN or service are not tied to a specific port or switch. This flexibility allows device mobility within the network while maintaining network security.

In This Chapter

This chapter provides an overview of the UNP feature and describes how to configure the port-based functionality and profile attributes through the Command Line Interface (CLI). CLI commands are used in the configuration examples; for more details about the syntax of commands, see the *OmniSwitch AOS Release 8 CLI Reference Guide*.

The following information and procedures are included in this chapter:

- [“Quick Steps for Configuring UNP” on page 30-7](#)
- [“UNP Overview” on page 30-20](#).
- [“Interaction With Other Features” on page 30-29](#).
- [“UNP Configuration Overview” on page 30-32](#).
- [“Configuring UNP Port-Based Access Control” on page 30-33](#).
- [“Configuring Profiles” on page 30-43](#).
- [“UNP Application Example” on page 30-54](#)
- [“Verifying the UNP Configuration” on page 30-57](#).

UNP Specifications

Platforms supported	OmniSwitch 6860, 6860E
Number of UNPs per switch	1K
Number of UNP users per switch	256
Authentication type	802.1X and MAC-based authentication
Profile type	Edge, VLAN, and SPB service
UNP port type	Edge, bridge, and SPB access
UNP classification rules	MAC address, MAC OUI, MAC address range, IP address, VLAN tag, Port, Group ID, authentication type, and LLDP (IP Phones TLV).
Number of QoS policy lists per switch	32 (includes the default list)
Number of QoS policy lists per UNP	1

UNP Defaults

The following default settings are applied when the Universal Network Profile (UNP) feature is enabled on a switch port.

UNP Port Configuration Defaults

By default, UNP functionality is disabled on all switch ports and link aggregates. When UNP is enabled on a port or link aggregate without specifying a port type, the following default parameter values for UNP edge ports are applied:

Description	Command	Default
UNP port type	unp port	Edge
MAC authentication	unp mac-authentication	Disabled
Alternate UNP for MAC authenticated traffic.	unp mac-authentication pass-alternate	None
Port bounce for MAC authenticated (non-supplicant) devices.	unp redirect port-bounce	Enabled
802.1X authentication	unp 802.1x-authentication	Disabled
Alternate UNP Edge profile for 802.1X authenticated traffic.	unp 802.1x-authentication pass-alternate	None
Attempt MAC authentication or classification when 802.1X authentication fails.	unp 802.1x-authentication failure-policy	Classification
Bypass the 802.1x authentication process for supplicants.	unp 802.1x-authentication bypass	Disabled
Attempt 802.1X authentication after MAC authentication when 802.1X bypass is enabled.	unp mac-authentication allow-eap	None
Rule-based classification	unp classification	Disabled
Default UNP Edge profile	unp default-edge-profile	None
Group ID assignment.	unp port group-id	0
AAA configuration profile assignment.	unp aaa-profile	None
Edge port template assignment.	unp port edge-template	None
Allow flooding of egress broadcast, unknown unicast, or multicast traffic.	unp direction	Both (blocked)
Trust the VLAN ID of a tagged packet to determine how the packet is classified.	unp trust-tag	Disabled
The amount of time before an EAP Request Identity is retransmitted.	unp 802.1x-authentication tx-period	30 seconds

Description	Command	Default
The amount of time before the switch times out an 802.1X user attempting to authenticate.	unp 802.1x-authentication supp-timeout	30 seconds
The maximum number of requests retransmitted before the session times out.	unp 802.1x-authentication max-req	2

UNP Global Configuration Defaults

The following global default values are applied to traffic received on all UNP ports or link aggregates:

Description	Keyword	Default
Authentication server down UNP	unp auth-server-down	None
Authentication server down timer	unp auth-server-down timeout	60 seconds
Port bounce for MAC authenticated (non-supplicant) devices	unp redirect port-bounce	Enabled
The amount of time to filter MAC addresses to trigger authentication	unp redirect pause-timer	0 (timer disabled)
HTTP proxy port number	unp redirect proxy-server-port	80, 8080, and 443
IP address to which HTTP traffic is redirected	unp redirect-server	None
Additional IP addresses to which a user can be redirected, other than the redirect server.	unp redirect allowed-name	None
Dynamic VLAN configuration for VLAN profiles.	unp dynamic-vlan-configuration	Disabled
Dynamic VLAN profile configuration.	unp dynamic-profile-configuration	Disabled
UNP Group ID	unp group-id	All edge ports belong to group 0.
UNP Customer Domain ID	unp customer-domain	All bridge and SPB access ports belong to domain 0.

UNP Profile Defaults

There are three types of UNP supported: Edge, VLAN, and SPB. This section provides the default values for all three types of profiles.

UNP Edge Profile Defaults

When a UNP Edge profile is created with the **unp edge-profile** command, the following default configuration is defined for the profile:

Description	Command	Default
QoS policy list.	unp edge-profile qos-policy-list	No list assigned
Location-based policy	unp edge-profile location-policy	No policy assigned
Time-based policy.	unp edge-profile period-policy	No policy assigned
Internal Captive Portal redirect.	unp edge-profile captive-portal-authentication	Disabled
Captive Portal configuration profile.	unp edge-profile captive-portal-profile	No profile assigned
The authentication flag status for successful authentication.	unp edge-profile authentication-flag	Disabled
Create a tagged VLAN-port-association between a UNP port and the VLAN associated with the Edge profile.	unp edge-profile mobile-tag	Disabled
OmniSwitch BYOD redirect.	unp edge-profile redirect	Disabled
Maximum bandwidth value for traffic received on UNP ports assigned to the Edge profile.	unp edge-profile maximum-ingress-bandwidth	No limit set
Maximum bandwidth value for traffic sent on UNP ports assigned to the Edge profile.	unp edge-profile maximum-egress-bandwidth	No limit set
How much the traffic can burst over the maximum ingress bandwidth rate applied to Edge profile ports.	unp edge-profile maximum-ingress-depth	Ingress bandwidth value divided by 25 or 2K (if calculation equals 0 or 1)
How much the traffic can burst over the maximum egress bandwidth rate applied to Edge profile ports.	unp edge-profile maximum-egress-depth	Egress bandwidth value divided by 25 or 2K (if calculation equals 0 or 1)
VLAN-to-profile mapping.	unp vlan-mapping edge-profile	None

See [“Configuring a UNP Edge Profile”](#) on page 30-43 for more information about Edge profiles.

UNP VLAN Profile Defaults

When a UNP VLAN profile is created with the **unp vlan-profile** command, the following default configuration is defined for the profile:

Description	Command	Default
QoS policy list.	unp vlan-profile qos-policy-list	No list assigned
Create a tagged VLAN-port-association between a UNP port and the VLAN associated with VLAN the profile.	unp vlan-profile mobile-tag	Disabled

Description	Command	Default
Maximum bandwidth value applied to traffic received on VLAN profile ports.	unp vlan-profile maximum-ingress-bandwidth	None
Maximum bandwidth value applied to traffic sent on VLAN profile ports.	unp vlan-profile maximum-egress-bandwidth	No limit set
How much the ingress traffic can burst over the maximum bandwidth rate applied to VLAN profile ports.	unp vlan-profile maximum-ingress-depth	No limit set
How much the egress traffic can burst over the maximum ingress bandwidth rate applied to VLAN profile ports.	unp vlan-profile maximum-ingress-depth	Ingress bandwidth value divided by 25 or 2K (if calculation equals 0 or 1)
How much the egress traffic can burst over the maximum egress bandwidth rate applied to VLAN profile ports.	unp vlan-profile maximum-egress-depth	Egress bandwidth value divided by 25 or 2K (if calculation equals 0 or 1)

See “[Configuring a UNP VLAN Profile](#)” on page 30-45 for more information about VLAN profiles.

UNP SPB Service Profile Defaults

When a UNP Shortest Path Bridging (SPB) service profile is created with the **unp spb-profile** command, the following default configuration is defined for the profile:

Description	Command	Default
QoS policy list.	unp spb-profile qos-policy-list	No list assigned
The replication mode for the service associated with the SPB profile.	unp spb-profile multicast-mode	head-end
Egress VLAN translation for Service Access Points (SAPs) associated with the SPB profile service.	unp spb-profile vlan-xlation	Disabled
Create a tagged VLAN-port-association between a UNP port and the BVLAN associated with the SPB profile service.	unp spb-profile mobile-tag	Disabled

See “[Configuring a UNP SPB Profile](#)” on page 30-48 for more information about SPB service profiles.

See [Chapter 7, “Configuring Shortest Path Bridging,”](#) for more information about SPB services.

Quick Steps for Configuring UNP

Configuring UNP involves defining profiles and setting UNP global and port-based parameters. The following quick steps provide a brief tutorial for configuring a UNP to authenticate and classify network devices:

Quick Steps for Configuring Profiles

There are three profile types supported: Edge, VLAN, and SPB. This section provides quick steps for configuring each type of supported profile.

Quick Steps for Configuring Edge Profiles

When a UNP Edge (VLAN-based) profile is created, default values are applied for the profile parameters described in this section (see [“UNP Edge Profile Defaults” on page 30-4](#)). Configuring these parameters is optional based on the functionality needed for the profile.

1 Use the **unp edge-profile** command to create a profile. For example, the following command creates the “EP-1” profile:

```
-> unp edge-profile EP-1
```

2 Use the **unp vlan-mapping edge-profile** command to assign a VLAN ID to a profile. When traffic received on a port is classified into the UNP, the port on which the traffic is received is assigned to the VLAN associated with the profile. For example, the following command assigns VLAN ID 500 to the “EP-1” profile:

```
-> unp vlan-mapping edge-profile EP-1 vlan 500
```

3 Use the **unp edge-profile qos-policy-list** command to optionally assign a list of QoS policy rules to a UNP (see [“Quick Steps for Configuring QoS Policy Lists” on page 30-18](#)). For example:

```
-> unp edge-profile EP-1 qos-policy-list qlist1
```

4 Use the **unp edge-profile location-policy** command to optionally assign an existing location-based policy to the profile. For example:

```
-> unp edge-profile EP-1 location-policy ale-na
```

5 Use the **unp edge-profile period-policy** command to optionally assign an existing time-based policy to the profile. For example:

```
-> unp edge-profile EP-1 period-policy plist1
```

6 Use the **unp edge-profile captive-portal-authentication** command to optionally enable or disable Captive Portal authentication for the profile. When enabled, a user undergoes a second stage of authentication through Captive Portal after the user is classified into the profile. For example:

```
-> unp edge-profile EP-1 captive-portal-authentication enable
```

7 Use the **unp edge-profile captive-portal-profile** command to optionally assign an existing Captive Portal configuration profile to the UNP Edge profile. For example:

```
-> unp edge-profile EP-1 captive-portal-profile CP1
```

8 Use the **unp edge-profile authentication-flag** command to optionally enable or disable the authentication flag for the profile. When enabled, only authenticated users are allowed into the profile. For example:

```
-> unp edge-profile EP-1 authentication-flag enable
```

9 Use the **unp edge-profile mobile-tag** command to optionally enable or disable the mobile tagging for the profile. When enabled, a tagged VLAN association is created when the user port moves into the profile VLAN. When disabled, VLAN association is untagged. For example:

```
-> unp edge-profile EP-1 mobile-tag enable
```

10 Use the **unp edge-profile redirect** command to optionally enable or disable the redirect status for the profile. When enabled, the profile can interact with the ClearPass Policy Manager (CPPM) server, as part of the OmniSwitch Bring Your Own Device (BYOD) solution. For example:

```
-> unp edge-profile EP-1 redirect enable
```

11 Use the **unp edge-profile** bandwidth commands to optionally configure the maximum ingress, egress, and depth bandwidth values that are applied to UNP ports that are assigned to the Edge profile. For example:

```
-> unp edge-profile EP-1 maximum-ingress-bandwidth 10M
-> unp edge-profile EP-1 maximum-egress-bandwidth 10M
-> unp edge-profile EP-1 maximum-ingress-depth 10000
-> unp edge-profile EP-1 maximum-egress-depth 10000
```

Note. Verify the profile configuration using the **show unp edge-profile** command. For example:

```
-> show unp edge-profile
Profile QoS      Location Period CP      Redirect CP      Authen Mobile Ingrs Egrs  Ingrs Egrs
Name   Policy Policy  Policy Profile State  State      Tag    BW    BW    Depth Depth
-----+-----+-----+-----+-----+-----+-----+-----+-----+-----+-----+-----+-----
EP-1   qlist1 ale-na  plist1 CP1    Ena    Ena    Ena    Ena    10M  10M  10000 10000
EP-2   qlist2 llist2  plist2 CP2    Dis    Dis    Dis    Dis
Total Edge-Profile Count: 2
```

Verify the VLAN mapping for each profile using the **show unp edge-profile vlan-mapping** command. For example:

```
-> show unp edge-profile vlan-mapping
Edge Profile Name      Vlan
-----+-----
EP-1                   500
Guest                  501
Total Edge-Profile Vlan-Map Count: 2
```

See the *OmniSwitch AOS Release 8 CLI Reference Guide* for information about the fields in this display.

For more information about defining Edge profile parameters, see “Configuring Profiles” on page 30-43.

Quick Steps for Configuring VLAN Profiles

When a UNP VLAN profile is created, default values are applied for the profile parameters described in this section (see “UNP VLAN Profile Defaults” on page 30-5). Configuring these parameters is optional based on the functionality needed for the profile.

1 Use the **unp vlan-profile** command to create a profile. For example, the following command creates the “unp4” profile:

```
-> unp vlan-profile unp4 vlan 200
```

2 Use the **unp vlan-profile qos-policy-list** command to optionally assign a list of QoS policy rules to a UNP (see “Quick Steps for Configuring QoS Policy Lists” on page 30-18). For example:

```
-> unp vlan-profile unp4 vlan 200 qos-policy-list unp4_list
```

3 Use the **unp vlan-profile mobile-tag** command to optionally enable or disable the mobile tagging for the profile. When enabled, a tagged VLAN association is created when the user port moves into the profile VLAN. When disabled, the VLAN association is untagged. For example:

```
-> unp vlan-profile unp4 vlan 200 mobile-tag enable
```

4 Use the **unp vlan-profile** bandwidth commands to optionally configure the maximum ingress, egress, and depth bandwidth values that are applied to UNP ports that are assigned to the VLAN profile. For example:

```
-> unp vlan-profile unp4 vlan 200 maximum-ingress-bandwidth 10M
-> unp vlan-profile unp4 vlan 200 maximum-egress-bandwidth 10M
-> unp vlan-profile unp4 vlan 200 maximum-ingress-depth 10000
-> unp vlan-profile unp4 vlan 200 maximum-egress-depth 10000
```

Note. Verify the profile configuration using the **show unp vlan-profile** command. For example:

```
-> show unp vlan-profile
Name  Vlan Policy   Saa      Status  Mobile MC Conf Ingrs  Egrs  Ingrs  Egrs
      List Name Profile Name      Tag    Status BW    BW    Depth Depth
-----+-----+-----+-----+-----+-----+-----+-----+-----+-----+-----+
unp1  500
unp2  501 unp2_list
unp3  100 unp3_list
unp4  200 unp4_list
      Active Dis   Local  10M  10M  10000 10000
      Active Dis   Local  10M  10M  10000 10000
      Active Dis   Local  10M  10M  10000 10000
      Active Ena   Local  10M  10M  10000 10000
```

See the *OmniSwitch AOS Release 8 CLI Reference Guide* for information about the fields in this display.

For more information about defining VLAN profile parameters, see “Configuring Profiles” on page 30-43.

Quick Steps for Configuring SPB Profiles

When a UNP SPB profile is created, default values are applied for the profile parameters described in this section (see [“UNP SPB Service Profile Defaults” on page 30-6](#)). Configuring these parameters is optional based on the functionality needed for the profile.

- 1 Use the **unp spb-profile** command to create a profile. For example, the following command creates the “spb1” profile:

```
-> unp spb-profile spb1 tag-value 10 isid 1525 bvlan 4001
```

The **tag-value**, **isid**, and **bvlan** parameters are used to define an SPB Service Access Point (SAP) for devices classified into the “spb1” profile.

- 2 Use the **unp spb-profile qos-policy-list** command to optionally assign a list of QoS policy rules to a UNP (see [“Quick Steps for Configuring QoS Policy Lists” on page 30-18](#)). For example:

```
-> unp spb-profile spb1 tag-value 10 isid 1525 bvlan 4001 qos-policy-list
spb1_list
```

- 3 Use the **unp spb-profile multicast-mode** command to change the multicast replication mode for the SPB service associated with the profile SAP. For example:

```
-> unp spb-profile spb1 tag-value 10 isid 1525 bvlan 4001 multicast-mode tandem
```

- 4 Use the **unp spb-profile vlan-xlation** command to change the VLAN translation status for the profile. For example:

```
-> unp spb-profile spb1 tag-value 10 isid 1525 bvlan 4001 vlan-xlation enable
```

- 5 Use the **unp spb-profile mobile-tag** command to optionally enable or disable the mobile tagging for the profile. When enabled, a tagged VLAN association is created when the user port moves into the profile SAP. When disabled, the VLAN association is untagged. For example:

```
-> unp spb-profile spb1 tag-value 10 isid 1525 bvlan 4001 mobile-tag enable
```

Note. Verify the profile configuration using the **show unp spb-profile** command. For example:

```
-> show unp spb-profile
Profile      Tag      Mcast  VLAN  QOS      Mobile
Name        Value    ISID/bVlan  Mode  Xlate  Policy List Name  Tag
-----+-----+-----+-----+-----+-----+-----
spb1         10      1525/4001  Tandem  Ena    spb1_list         Ena
spb2        10:500   2000/4001  Head-end  Dis
```

See the *OmniSwitch AOS Release 8 CLI Reference Guide* for information about the fields in this display.

For more information about defining SPB profile parameters, see [“Configuring Profiles” on page 30-43](#).

Quick Steps for Configuring Global UNP Parameters

Default values are applied for the global UNP parameters described in this section (see “UNP Global Configuration Defaults” on page 30-4). Configuring these parameters is optional based on the need for the functionality these parameters provide.

1 Use the **unp auth-server-down** command to specify the name of a temporary UNP to which a device is assigned if the RADIUS server is unreachable. For example:

```
-> unp auth-server-down edge-profile UNP-temp
```

2 Use the **unp auth-server-down timeout** command to configure how long a device remains in the authentication server down UNP. The timer is set to 60 seconds by default and is triggered when a device is learned in the authentication server down UNP. For example:

```
-> unp auth-server-down edge-profile timeout 60
```

3 Use the **unp redirect port-bounce** command to optionally enable or disable the port bounce action on UNP ports. For example:

```
-> unp redirect port-bounce enable
```

4 Use the **unp redirect pause-timer** command to configure how long, in seconds, the switch will filter traffic to trigger re-authentication. When the timer value is set to zero, the timer is disabled. For example:

```
-> unp redirect pause-timer 180
```

5 Use the **unp redirect proxy-server-port** command to configure the HTTP proxy server port number to use for redirection to a ClearPass Policy Manager (CPPM) server. For example:

```
-> unp redirect proxy-server-port 8887
```

6 Use the **unp redirect-server** command to configure an IP network address to allow redirection of HTTP traffic to a CPPM server. For example:

```
-> unp redirect-server 10.255.95.250
```

7 Use the **unp redirect allowed-name** command to configure additional IP network addresses to which a user can access (these are in addition to the CPPM server IP address). For example:

```
-> unp redirect allowed-name DomainController ip-address 10.255.95.210 ip-mask  
255.255.255.255
```

8 Use the **unp dynamic-vlan-configuration** command to enable the switch to automatically create a VLAN if the VLAN ID specified for a UNP VLAN profile does not already exist.

```
-> unp dynamic-vlan-configuration enable
```

Note. Dynamic UNP VLANs are not saved in the switch configuration file (**boot.cfg**). When the next switch reboot occurs, the device ages out, or the UNP is deleted, the dynamic VLAN configuration is removed.

9 Use the **unp dynamic-profile-configuration** command to enable the switch to automatically create a UNP VLAN profile. The profile is dynamically created when the trust VLAN tag is enabled for the UNP port and the VLAN tag of an ingress packet matches an MVRP VLAN that is not assigned to a profile, or the VLAN ID of the tag does not exist on the switch.

```
-> unp dynamic-profile-configuration enable
```

Note. Verify the UNP global parameter configuration using the **show unp global configuration** command. For example:

```
-> show unp global configuration
Mode : Bridge
  Dynamic Vlan Configuration      = Enabled,
  Dynamic Profile Configuration   = Disabled,
  Auth Server Down UNP           = UNP-temp,
  Auth Server Down Timeout       = 120,

Mode : Edge
  Auth Server Down UNP           = UNP-temp,
  Auth Server Down Timeout       = 60,
  Redirect Port Bounce           = Enabled,
  Redirect Pause Timer           = 180
  Redirect http proxy-port       = 8080
  Redirect Server IP             = 10.255.95.250
  Allowed IP                     = DomainController,
                                10.255.95.241/255.255.255.255,
```

See the *OmniSwitch AOS Release 8 CLI Reference Guide* for information about the fields in this display.

Quick Steps for Configuring UNP Port Parameters

By default UNP functionality is disabled on all switch ports. When UNP is enabled on a port or link aggregate, default values for the port parameters described in this section are applied to the UNP port or link aggregate (see “UNP Port Configuration Defaults” on page 30-3). Configuring these parameters is optional based on the UNP functionality needed on the port.

1 Use the **unp port** command to enable UNP functionality on switch ports or link aggregates. Once enabled, the port becomes eligible for dynamic assignment based on the UNP authentication and classification configuration for the switch.

```
-> unp port 1/1/1-5 port-type spb-access
-> unp linkagg 4 port-type bridge
-> unp port 1/1/10-20 port-type edge
```

2 Use the **unp port edge-template** command to assign a pre-defined edge port configuration to a UNP edge port. An Edge port template can be used to apply pre-defined values for the port parameters described in this section.

```
-> unp port 1/1/10 edge-template classify-template
```

3 Use the **unp port group-id** command to assign a UNP edge port to a numerical Group ID.

```
-> unp port 1/1/1-3 group-id 2
```

4 Use the **unp unp-customer-domain** command to assign UNP bridge and SPB access ports to a numerical customer domain ID.

```
-> unp port 1/1/1-3 customer-domain 1
```

5 Use the **unp default-edge-profile** command to designate an existing UNP Edge profile as the default profile for an edge port. Devices are assigned to the default profile when UNP authentication and/or classification is not available or is unsuccessful.

```
-> unp port 1/1/10 default-edge-profile def_unp1
```

6 Use the **unp default-vlan-profile** command to designate an existing UNP VLAN profile as the default profile for a bridge port. Devices are assigned to the default profile when UNP authentication and/or classification is not available or is unsuccessful.

```
-> unp port 1/1/11 default-vlan-profile def_vlan_unp1
```

7 Use the **unp default-spb-profile** command to designate an existing UNP SPB profile as the default profile for an SPB access port. Devices are assigned to the default profile when UNP authentication and/or classification is not available or is unsuccessful.

```
-> unp port 1/1/11 default-spb-profile def_spb_unp1
```

8 Use the **unp aaa-profile** command to assign an existing AAA configuration profile to a UNP edge port.

```
-> unp port 1/1/10 aaa-profile A1
```

9 Use the **unp mac-authentication** command to enable MAC authentication on the UNP port.

```
-> unp port 1/1/10 mac-authentication enable
```

10 Use the **unp mac-authentication pass-alternate** command to designate an existing profile to which a device is assigned if successful MAC authentication does not return a UNP name.

```
-> unp port 1/1/10 mac-authentication pass-alternate-unp MacPass
```

11 Use the **unp 802.1x-authentication** command to enable 802.1X authentication on the UNP port.

```
-> unp port 1/1/10 802.1x-authentication enable
```

12 Use the **unp 802.1x-authentication pass-alternate** command to designate an existing profile to which a device is assigned if successful 802.1x authentication does not return a UNP name.

```
-> unp port 1/1/10 802.1x-authentication pass-alternate-unp 1xPass
```

13 Use the **unp 802.1x-authentication tx-period** command to configure the amount of time to wait (in seconds) between transmissions of 802.1X EAP Request Identity packets on the UNP port.

```
-> unp port 1/1/10 802.1x-authentication tx-period 60
```

14 Use the **unp 802.1x-authentication supp-timeout** command to configure the amount of time to wait before timing out 802.1X users attempting to authenticate on the UNP port.

```
-> unp port 1/1/10 802.1x-authentication supp-timeout 120
```

15 Use the **unp 802.1x-authentication max-req** command to configure the maximum number of times to requests for authentication information are transmitted to the 802.1X users on the UNP port.

```
-> unp port 1/1/10 802.1x-authentication max-req 10
```

16 Use the **unp 802.1x-authentication bypass** command to configure whether 802.1X authentication is skipped on the UNP port.

```
-> unp port 1/1/10 802.1x-authentication bypass enable
```

Configuring the bypass option is not allowed if an 802.1x authentication failure policy is configured for the UNP port.

17 Use the **unp mac-authentication allow-eap** command to configure whether 802.1X authentication is attempted after MAC authentication on a UNP port that has 802.1X authentication bypass enabled.

```
-> unp port 1/1/10 mac-authentication allow-eap pass
```

In this example, 802.1X authentication is attempted only when MAC authentication passes.

18 Use the **unp 802.1x-authentication failure-policy** command to configure whether or not MAC authentication is attempted after the initial 802.1X authentication attempt fails.

```
-> unp port 1/1/10 802.1x-authentication failure-policy mac-authentication
```

Configuring an 802.1X failure policy is not allowed if the 802.1X bypass operation is enabled on the UNP port.

19 Use the **unp classification** command to enable classification on the UNP port. When enabled, UNP classification rules are applied to device traffic received on the port when 802.1X or MAC authentication is not available or is unsuccessful. See [“Quick Steps for Configuring UNP Classification Rules” on page 30-16](#).

```
-> unp port 1/1/10 classification enable
```

20 Use the **unp trust-tag** command to configure the trust VLAN ID tag status for the UNP port. When enabled, the VLAN ID of a tagged packet is used to determine how the packet is classified.

```
-> unp port 1/1/10 trust-tag enable
```

21 Use the **unp direction** command to configure whether network access control is applied to both incoming and outgoing traffic or only applied to incoming traffic on a UNP edge or bridge port.

```
-> unp port 1/1/10 direction in
```

The **unp direction** command options are **in** and **both** (the default). When the direction is set to **both**, then egress broadcast, unknown unicast, and multicast traffic is blocked on the UNP port. When the direction is set to **in**, these same traffic types are not blocked.

Note. Verify the UNP port configuration using the **show unp port** command with the **config** option. For example:

```
-> show unp port 1/1/11 config
Port 1/1/11
  Port-Type                : Edge,
  Redirect Port Bounce     : Enabled,
  802.1x authentication    : Enabled,
  802.1x Pass Alternate Profile : 1xPass,
  802.1x Bypass            : Disabled,
  802.1x failure-policy    : default,
  Mac-auth allow-eap       : none,
  Mac authentication       : Enabled,
  Mac Pass Alternate Profile : -,
  Classification           : Disabled,
  Default Profile          : -,
  Group-ID                 : 0,
  AAA Profile              : -,
  Edge Template            : AG-With-Auth,
  Port Control Direction   : Both,
  Egress Flooding          : Not Allowed,
  Trust-tag Status         = Disabled,
  802.1x Parameters:
    Tx-Period              : 30,
    Supp-Timeout           : 30,
    Max-req                 : 2
```

To display summary information about the UNP port configuration, use the **show unp port** command. For example:

```
-> show unp port
Port  Grp-ID/ Type      802.1x  Mac      Class.  Default  802.1X  MAC
      CDomain  Auth    Auth     Disabled  EdgeDef-1  Pass-Alt Pass-Alt
-----+-----+-----+-----+-----+-----+-----+-----+-----+
1/1/6  0      Edge    Disabled Disabled Enabled  EdgeDef-1  -      -
1/1/7  0      Edge    Enabled  Disabled Disabled EdgeDef-1  -      -
1/1/8  0      Bridge  Enabled  Disabled Disabled -          -      -
1/1/9  0      SPB Access Enabled  Enabled  Disabled -          1xPass  MacPass
1/1/15 0      Edge    Disabled Disabled Disabled EdgeDef-1  -      -
```

To display information about device MAC addresses learned on a UNP port, use the **show unp user** command. For example:

```
--> show unp user
Port  Username          Mac address          User
      Username      Mac address          IP      Vlan Profile  Type  Status Source
-----+-----+-----+-----+-----+-----+-----+-----+
0/100 00:00:00:00:00:03 00:00:00:00:00:03 1.1.1.3 12 Profile3 Bridge Active Local
1/1/1 00:00:00:00:00:01 00:00:00:00:00:01 1.1.1.1 10 Profile1 Access Active Local
1/1/2 00:00:00:00:00:02 00:00:00:00:00:02 1.1.1.2 11 Profile2 Bridge Active Local

Total users : 3
```

See the *OmniSwitch AOS Release 8 CLI Reference Guide* for information about the fields in this display.

Quick Steps for Configuring UNP Classification Rules

When classification is enabled for a UNP port, UNP classification rules are applied to traffic received on that port to determine the UNP VLAN or SPB service assignment for the traffic. The following quick steps provide a brief tutorial for configuring some of the types of classification rules available:

- 1 Use the **unp classification port** command to classify a device based on the port to which the device is connected. This rule is only available to classify a device into a UNP Edge profile.

```
-> unp classification port 1/1/5 edge-profile myProfile1
```

- 2 Use the **unp classification group-id** command to classify a device based on the Group ID associated with the UNP edge port to which the device is connected. This rule is only available to classify a device into a UNP Edge profile.

```
-> unp classification group-id GRP1 edge-profile myProfile1
```

- 3 Use the **unp classification mac-address** command to classify a device based on the source MAC address of the device.

```
-> unp classification mac-address 00:00:2a:33:44:01 edge-profile serverA
```

- 4 Use the **unp classification mac-oui** command to classify a device based on the Organizationally Unique Identifier (OUI) of the source MAC address associated with a device. This rule is only available to classify a device into a UNP Edge profile.

```
-> unp classification mac-oui 00:11:22 edge-profile myProfile1
```

- 5 Use the **unp classification mac-address-range** command to classify device MAC addresses that fall within a range of MAC addresses.

```
-> unp classification mac-address-range 00:00:2a:33:44:01 00:00:2a:33:44:10  
edge-profile name serverB
```

- 6 Use the **unp classification lldp med-endpoint ip-phone** command to classify an IP phone when the LLDP TLVs from the phone are detected. This rule is only available to classify a device into a UNP Edge profile.

```
-> unp classification lldp med-endpoint ip-phone edge-profile myProfile1
```

7 Use the **unp classification authentication-type** command to classify a device based on the type of authentication the device successfully completed. This rule is only available to classify a device into a UNP Edge profile.

```
-> unp classification authentication-type 802.1X edge-profile myProfile1
```

8 Use the **unp classification ip-address** command to classify a device based on the source IP address of the device.

```
-> unp classification ip-address 198.4.21.1 255.255.0.0 edge-profile marketing
```

9 Use the **unp classification vlan-tag** command to classify a device based on the VLAN ID tag of the device traffic.

```
-> unp classification vlan-tag 10 edge-profile marketing
```

Quick Steps for Configuring Binding Rules

The Port and Group ID classification rules can be combined with other individual rules to create a binding rule. A device must match all the rules defined in a binding rule. This capability is only available when configuring binding rules for UNP Edge profiles. The following quick steps provide a brief tutorial for how to configure a binding rule combination.

1 To configure a MAC address and port binding rule combination, use the **unp classification mac-address** command with the **mac-address** and **port** parameter options.

```
-> unp classification mac-address 00:11:22:33:44:55 port 1/1/10 edge-profile Pr1
```

2 To configure a MAC address and Group ID binding rule combination, use the **unp classification mac-address** command with the **mac-address** and **group-id** parameter options.

```
-> unp classification mac-address 00:11:22:33:44:55 group-id GRP1 edge-profile Pr1
```

3 To configure a MAC address, IP address, and port binding rule combination, use the **unp classification mac-address** command with the **mac-address**, **ip-address**, and **port** parameter options.

```
-> unp classification mac-address 00:11:22:33:44:55 ip-address 10.0.0.20 mask 255.255.0.0 port 1/1/1 edge-profile Pr3
```

4 To configure a MAC address, IP address, port, and VLAN tag binding rule combination, use the **unp classification mac-address** command with the **mac-address**, **ip-address**, **port**, and **vlan-tag** parameter options.

```
-> unp classification mac-address 00:11:22:33:44:55 ip-address 10.0.0.20 255.255.0.0 port 1/1/1 vlan-tag 10 edge-profile Pr3
```

Note. Verify the UNP classification rule configuration using the `show unp classification` command. For example:

```
-> show unp classification mac-rule
Customer
Domain  MAC Address          Vlan Profile          SPB Profile          Vlan
Name    Name                      Name                  Name                  Tag
-----+-----+-----+-----+-----
0       00:00:5e:2a:95:11  VNP-10                -                    0
1       00:0f:b5:46:d7:56  -                      SLA-20               20
2       00:2a:95:57:e1:67  ServerA-VMs          -                    0
```

```
-> show unp classification edge-profile mac-rule
MAC Address          VLAN Tag  Edge Profile Name
-----+-----+-----
00:11:22:33:44:11  -        Sales1
00:11:22:33:44:22  100     Sales2
00:11:22:33:44:55  -        Sales3
```

Total Mac Rule Count: 3

```
-> show unp classification edge-profile ip-group-rule
Group-ID  IP          VLAN Tag  Edge-Profile
-----+-----+-----+-----
1         10.255.1.4  -        CustA
```

Total IP-Group-ID Binding Rule Count: 1

```
-> show unp classification vlan-profile mac-rule
Customer
Domain  Mac Address          Vlan Profile          VLAN Tag
-----+-----+-----+-----
0       00:00:5e:2a:95:11  VNP-10                0
```

```
-> show unp classification spb-profile vlan-tag-rule
Customer Domain VLAN Tag SPB-Profile          Tag Position
-----+-----+-----+-----+-----
0         2         SLA-2                Inner
```

See the *OmniSwitch AOS Release 8 CLI Reference Guide* for information about the fields in this display.

Quick Steps for Configuring QoS Policy Lists

Assigning a QoS policy list to a UNP is done to enforce device access to network resources. A policy list consists of one or more QoS policy rules; the list is assigned a name that is used to associate the list with the UNP. The following quick steps provide a brief tutorial for configuring a QoS policy list:

- 1 Create one or more QoS policy rules using the `policy rule` command.

```
-> policy condition any source ip any destination ip any
-> policy action allow
-> policy rule allow_all condition any action allow
```

- 2 Create a QoS policy list using the `policy list` command.

```
-> policy list type unp Employee-role
```

- 3** Assign one or more QoS policy rules to the policy list using the **policy list rules** command.

```
-> policy list employee-role rules allow_all
```

- 4** Assign the QoS policy list to a UNP using the **unp edge-profile**, **unp vlan-profile**, or **unp spb-profile** command.

```
-> unp edge-profile Employee vlan 500 qos-policy-list logon-role
-> unp vlan-profile un1 vlan 200 qos-policy-list employee-role
-> unp spb-profile spb2 tag-value 20:100 isid 1525 bvlan 4001 qos-policy-list
service-user
```

Note. Verify the QoS policy list configuration using the **show policy list** command. For example:

```
-> show policy list
Group Name                               From  Type   Enabled  Entries
-----+-----+-----+-----+-----
Employee-role                            cli   unp     Yes      allow_all
logon-role                                cli   unp     Yes      allow-cppm-server
                                             redirect-to-cppm-server
```

Verify the UNP association for the policy list using the **show unp edge-profile** command. For example:

```
-> show unp edge-profile
Profile  QoS      Location  Period    CP          Redirect CP   Authen Mobile
Name     Policy   Policy    Policy    Profile     State  State  State  Tag
-----+-----+-----+-----+-----+-----+-----+-----+-----
Employee Employee-role alu-na  office-time CP1        Dis    Ena    Ena    Ena
Guest   logon-role  --      --        --         Ena    Dis    Dis    Dis
```

See the *OmniSwitch AOS Release 8 CLI Reference Guide* for information about the fields in this display.

UNP Overview

A Universal Network Profile (UNP) provides a method for dynamically assigning network devices to a VLAN domain. A profile consists of configurable attributes that help to define a group of users or devices that have similar requirements for access to network resources. A device sending traffic that matches such attributes is then assigned to a VLAN that is associated with the UNP. The UNP may also specify a QoS policy list that is subsequently applied to device traffic associated with the UNP.

Dynamic assignment of devices using UNPs is achieved through port-based functionality that provides the ability to authenticate and classify device traffic. Authentication verifies the device identity and provides a UNP name. In the event authentication is not available or is unsuccessful, classification rules associated with the UNPs, as well as the UNP port configuration attributes, are applied to the traffic to determine the UNP assignment.

Profile Types

UNP supports three types of classification profiles:

- **VLAN profile.** This type of profile creates a VLAN-port association (VPA) for device traffic that is classified into the profile. The VPA represents an association between the UNP port on which the device traffic was received and the VLAN ID specified by the profile. Once classified into a specific profile, device traffic is tagged to forward on the UNP VLAN.
- **Edge profile.** This type of profile also creates a VPA between the UNP port on which device traffic was received and the VLAN ID associated with the profile. Device traffic is then forwarded on the VLAN ID associated with the profile. Specifically designed to offer network access control to edge devices, Edge profiles offer additional attributes to redirect devices for internal Captive Portal authentication and integration with the OmniSwitch Bring Your Own Device (BYOD) solution.
- **SPB profile.** The OmniSwitch supports Shortest Path Bridging (SPB) service profiles. This type of profile creates an association between device traffic that is classified into the profile and a Service Access Point (SAP). Once classified into a specific profile, device traffic is then forwarded on the SPB service associated with the SAP.

The OmniSwitch supports two separate traffic domains: VLAN and service. The availability of two VLAN-based profiles (Edge and VLAN) and an SPB service profile provides an efficient method for network access control and dynamic assignment of device traffic to one of these domains.

Using the VLAN and Edge profiles, an administrator can implement the same UNP name across the entire network infrastructure, as the VLAN association is kept locally on each switch. For example, the administrator can deploy the UNP named “Engineering” in one building using VLAN 10, while the same UNP deployed in another building can use VLAN 20. The same UNP access controls are applied to all profile devices in each building, even though they belong to different VLANs.

The SPB service profile is particularly useful in the Alcatel-Lucent Data Center solution to facilitate virtual machine (VM) discovery and movement. UNP service profiles used for such purposes are also referred to as virtual network profiles (vNPs).

The following table provides a list of configurable profile attributes and the profile type (VLAN, Edge, or SPB) that supports each attribute. For example:

- Classification rules are configurable for a UNP Edge, VLAN, and SPB profile, so the “Supported Profile” field contains “All profiles” for this attribute.

- The VLAN mapping is only configurable for a UNP Edge and VLAN profile, so the “Supported Profile” field contains “Edge and VLAN profiles” for this attribute.

Profile Attribute	Supported Profile
Classification Rules. A UNP can specify classification rules that are used to assign devices to a profile based on the source MAC address, source IP address, or VLAN tag of device packets. UNP rules are applied based on the outcome of authentication.	All profiles
QoS policy list name. Specifies the name of an existing list of QoS policy rules. The rules within the list are applied to all members of the profile group to enforce access to network resources. Only one policy list is allowed per profile, but multiple profiles may use the same policy list. See “Configuring QoS Policy Lists” on page 30-50 for more information.	All profiles
Mobile tag. The mobile tag status for the profile. When enabled, the UNP port to which a device is connected is tagged with the VLAN mapped to the profile when the device is classified into that profile.	All profiles
VLAN ID (VLAN mapping). All members of the profile group are assigned to the VLAN ID specified by the profile (also referred to as the UNP VLAN).	Edge and VLAN profiles
Maximum ingress and egress bandwidth. The maximum bandwidth limit allocated for ingress and egress traffic on UNP ports assigned to the profile.	Edge and VLAN profiles
Maximum ingress and egress depth. Specifies how much ingress and egress traffic can burst over the maximum ingress and egress bandwidth rate.	Edge and VLAN profiles
Tag value. A VLAN tag value that UNP uses to determine the Service Access Point (SAP) to which classified traffic is mapped. If this value is set to zero, untagged traffic is classified to this profile creating an untagged SAP.	SPB profile
Service Instance Identifier (I-SID). A service instance identifier that is used to identify an SPB service in a provider backbone bridge (PBB) network. The specified I-SID is bound to the SPB BVLAN for the profile.	SPB profile
Backbone VLAN (BVLAN). The SPB BVLAN on which classified profile traffic is forwarded. The BVLAN ID specified must already exist in the switch configuration.	SPB profile
Location-based policy. Defines criteria (such as the slot/port, system name and location) to determine if a device is accessing the network from a valid location. If a device violates this policy, the device is placed into an unauthorized state, even though it is still assigned to the profile.	Edge profile
Time-based policy. Specifies the days and times during which a device can access the network. If a device violates this policy, the device is placed into an unauthorized state, even though it is still assigned to the profile.	Edge profile
Captive Portal authentication. Configures the Captive Portal status for the profile. When enabled, the internal Captive Portal authentication process is triggered when a user device is assigned to the profile.	Edge profile

Profile Attribute	Supported Profile
Captive Portal profile. Specifies the name of a Captive Portal configuration profile to apply to user devices when Captive Portal authentication is enabled for the UNP. The configuration defined in the Captive Portal profile overrides the global Captive Portal configuration for the switch.	Edge profile
Redirect flag. Configures the redirect status for the profile. When enabled, the profile will interact with the ClearPass Policy Manager (CPPM) as part of the OmniSwitch Bring Your Own Devices (BYOD) solution	Edge profile

UNP Dynamic VLANs

When a UNP VLAN profile is created, specifying a VLAN ID is required. Traffic that is classified with the UNP is assigned to the associated VLAN. There are two methods for creating this type of VLAN:

- Using standard VLAN management commands, create the VLAN then assign the VLAN to the UNP at the time the profile is created.
- Enabling the UNP dynamic VLAN configuration option to automatically create the VLAN, if it does not exist, at the time the UNP is created.

VLANs that are automatically created at the time the profile is created are referred to as UNP dynamic VLANs. These VLANs carry many of the same attributes as standard VLANs, such as:

- The VLAN status (enabled or disabled) is configurable.
- Additional ports (tagged and untagged) can be assigned to dynamic VLANs.
- The STP status is configurable and is enabled by default for dynamic VLANs. This STP instance is included in the maximum number of 1x1 STP instances allowed when the switch is running in the 1x1 STP mode.

However, UNP dynamic VLANs differ from standard VLANs as follows:

- A dynamic VLAN cannot be deleted using standard VLAN commands. The VLAN is only removed when the UNP to which the VLAN is assigned is deleted.
- UNP dynamic VLANs are identified as a separate type of VLAN. The **vlan show** commands will display this type of VLAN with the default name of “UNP-DYN-VLAN” and the designated type as “UNP Dynamic Vlan”.
- Dynamic VLANs are not saved in the “! VLAN:” section of the switch configuration file (**boot.cfg**). However, the **unp** commands to enable dynamic VLAN configuration and create the UNP are saved in the “! DA-UNP:” section of the **boot.cfg** file. As a result, the VLAN is created again on the next switch bootup.

For more information, see [“Enabling Dynamic VLAN Configuration” on page 30-46](#).

Dynamic VLAN Profiles

UNP functionality provides the ability to dynamically create VLAN classification profiles based on very specific traffic conditions. A UNP profile is dynamically created when the trust VLAN tag option is enabled on the UNP port or link aggregate and one of the following conditions occurs:

- A tagged packet received on the UNP port contains a VLAN tag that matches an existing MVRP VLAN in the switch configuration that is not assigned to a profile.

- There is no matching VLAN in the switch configuration.

Dynamic profiles are saved in the switch configuration, and profile attributes are configurable in the same manner as manually created profiles.

SPB Service Access Point

The SPB service profile attributes are used to define a Service Access Point (SAP) for traffic that is classified by the service profile.

- The VLAN tag attribute value combined with a local UNP SPB access port, on which matching profile traffic is received, specifies the encapsulation value for the SAP.
- The I-SID and BVLAN ID attribute values specify a backbone service for the SAP and is the service that will forward the matching profile traffic through the network.

The VLAN tag, I-SID, and BVLAN attributes define the SAP components that are used to service device traffic mapped to the SPB profile.

For more information about the OmniSwitch implementation of SPB, see [Chapter 7, “Configuring Shortest Path Bridging,”](#) in the *OmniSwitch AOS Release 8 Network Configuration Guide*.

Dynamic SAP Configuration

When device traffic is assigned to a service profile, UNP first checks the switch configuration to see if a SAP already exists for the VLAN tag and other service profile attribute values that are specific to the type of service profile (SPB or VXLAN). If a SAP already exists with these values, the device traffic is classified into that SAP. If the SAP does not exist, the switch dynamically creates one based on the service profile attribute values.

- If the I-SID value specified in an SPB service profile does not exist, the switch will dynamically create the expected service with the specified I-SID and then the SAP. This is similar to functionality in the VLAN domain, where UNP will dynamically create a VLAN based on the 802.1Q-tag of the device traffic.
- If the BVLAN ID specified in the SPB service profile does not exist, the dynamic SAP is not created.
- If the VNID value specified in a VXLAN service profile does not exist, the switch will dynamically create the expected service with the specified VNID and then the SAP.

Dynamically creating services and related SAPs is subject to available switch resources. If an attempt to dynamically create a service or SAP fails, for any reason, the MAC addresses classified for the service profile are learned as filtering.

Note. Dynamically created SAPs are not saved to the switch configuration file.

System Default Profiles

To further automate SAP configuration, UNP also supports dynamically creating a “System Default” service profile for traffic received on UNP access ports that is *not* classified into a user-defined UNP service profile. A Service Default profile specifies the attributes used to dynamically create a SAP for the traffic. The attributes specified through the System Default profile are derived using the system parameter values and calculations described in the following sections.

UNP derives the System Default profile attributes as follows to dynamically create a SAP for SBP traffic:

- **BVLAN**—The SPB control BVLAN configured for the switch serves as the BVLAN for the dynamic SAP.
- **I-SID number**—The system default I-SID number (10,000,000) plus the customer domain ID number (zero by default) multiplied by 10,000. For example, if the UNP access port on which traffic is received belongs to customer domain 200, then the calculation to determine the I-SID is as follows:

$$10,000,000 + (200 * 10,000) = 12,000,000$$

- **SPB Service ID number**—A reserved service ID (32768) that represents the association between the default system I-SID and the control BVLAN. This value increments by 1 for each additional dynamic service (SPB or VXLAN) that is created and only has local significance.

UNP Port Types

By default, all switch ports are non-UNP (fixed) ports that are statically assigned to a specific VLAN. Once UNP is enabled on a port, traffic from each device connected to that port is classified using the UNP port and profile configuration to determine the VLAN or service assignment for the device.

There are three types of UNP ports supported: edge, bridge, and SPB access. The port type is specified when UNP functionality is enabled on the port and determines how traffic received on the port is classified. For example:

- UNP edge port traffic is classified using Edge-based profiles.
- UNP bridge port traffic is classified using VLAN-based profiles.
- UNP service access port traffic is classified using service-based SPB profiles.

When a UNP bridge port is dynamically assigned to a VLAN that is associated with an Edge or VLAN profile, a VLAN port association (VPA) is created and tracked by VLAN management software on each switch. Because the UNP configuration is applied to each device connected or forwarded through a UNP port, the UNP port can associate with more than one VLAN.

UNP access ports are not dynamically assigned to VLANs. Instead, traffic received on the port is classified to a Service Access Point (SAP). A SAP is a virtual port that maps classified device traffic to a service.

UNP Port Domains

UNP port domains provide an additional method for segregating device traffic. A domain is identified by a numerical ID, which can be assigned to UNP ports and profile classification rules. By default, all UNP ports and profile rules are assigned to domain 0.

The main benefit of UNP port domains is that they provide the ability to group physical UNP ports or link aggregates into one logical domain. Once a UNP port is assigned to a specific domain ID, only classification rules associated with the same domain ID are applied to that port.

An example of using domains would be to group all UNP ports carrying traffic for a specific customer into the same domain (all Customer A ports assigned to domain 2). Then assign profiles tailored for that customer to the same domain ID (all profiles for Customer A assigned to domain 2).

There are two methods for defining UNP port domains: assigning ports to a group ID or assigning ports to a customer domain ID. The method to use is determined by the port type. For example, UNP edge ports are assigned to a group ID, but UNP bridge and SPB access ports are assigned to a customer domain ID. Both the group ID and customer domain ID serve the same purpose: to group UNP ports into a logical domain for authentication and classification purposes.

Device Authentication and Classification

Authentication is one method for classifying device traffic into a UNP VLAN or service. If the authentication process is successful and returns a UNP name, the authenticated device is assigned to the VLAN associated with that UNP name.

This implementation of UNP supports 802.1X-based and MAC-based RADIUS device authentication. This type of authentication does not require an agent or special protocol on the device; the source MAC address of the device is verified through a remote RADIUS server.

Successful device authentication can result in a UNP profile assignment for the user device. However, if authentication is not available or does not return a profile name for whatever reason, the following additional UNP device classification methods are available to classify a user device into a profile:

- **UNP classification rules.** Switch-wide classification rules to classify users based on port and device attributes (for example, source MAC, Group ID, IP address). Classification rules are associated with profiles and are applied to traffic received on all UNP-enabled ports. When any of the traffic matches one of the UNP rules, the user device is dynamically assigned to the matching profile.
- **Alternate pass UNP.** A UNP associated with a UNP port to which traffic is assigned when successful 802.1X or MAC authentication does not return a UNP name.
- **Default UNP.** A UNP associated with a UNP port to which traffic is assigned when other authentication or classification attempts fail to provide a profile name.
- **Trust VLAN tag.** Configured on a UNP port to specify whether or not to trust the VLAN tag of the packets received on the port. If this option is enabled and the VLAN tag matches an existing VLAN in the switch configuration, the traffic is assigned to that VLAN when other authentication or classification attempts fail to provide a profile name.
- **Authentication server down UNP.** A global VLAN UNP that provides a temporary profile for devices unable to authenticate because the RADIUS server is unreachable. This profile is associated with a timer that determines how long the device remains in the temporary profile before authentication is attempted again.

Enabling 802.1X and/or MAC authentication is optional with UNP; an administrator may decide to use UNP classification rules instead. When enabled, however, the authentication method takes precedence over classification rules.

UNP Classification Rules

Classifying devices with UNP classification rules allows the administrator to assign users to a profile group based on port and device attributes, such as the source IP address, source MAC address, port, or group ID, of the device. For example:

- Classification is enabled on UNP port 1/1/10.
- A MAC address range classification rule is associated with a UNP Edge profile named “Engineering”. This rule defines a MAC address range of “00:11:22:33:44:55 through 00:11:22:33:44:66”.
- A device connecting to port 1/1/10 with a source MAC address that falls within the specified MAC address range is assigned to the “Engineering” profile. The device and port on which the device was learned are also dynamically assigned to the VLAN associated with the profile.

Enabling classification and defining classification rules is optional with UNP. When enabled, however, classification rules are only applied to UNP ports when one of the following occurs:

- 802.1X and MAC authentication are disabled on the port.
- 802.1X and/or MAC authentication is enabled but the RADIUS server is not configured.
- 802.1X and/or MAC authentication is enabled but RADIUS authentication did not return a UNP name or failed.

If classification is disabled on a UNP port, classification rules are not applied to traffic received on that port. If both authentication and classification are disabled on a UNP port, traffic received on that port is blocked, unless a default UNP is configured for that port.

UNP Rule Types

A classification rule specifies the criteria that a device must match and the name of a UNP Edge, VLAN, or SPB profile that is applied to the device when the match occurs. The following table lists all the UNP classification rules and the type of UNP profile that supports each rule. For example:

- The MAC address rule is configurable for a UNP Edge, VLAN, and SPB profile, so the “Supported Profile” field contains “All profiles” for the MAC address rule type.
- The Port rule is only configurable for a UNP Edge profile, so the “Supported Profile” field contains “Edge profile” for the Port rule type.

The rules are listed in the order of precedence (highest to lowest).

Precedence Step/Rule	Matching Condition	Supported Profile
1. Port + VLAN tag	Packet is learned on a matching port or link aggregate <i>and</i> the packet contains a matching VLAN ID tag.	Edge profile
2. Port	Packet is learned on a matching port or link aggregate.	Edge profile
3. Group ID + VLAN tag	Packet is learned on a port or link aggregate that is assigned to a matching group ID <i>and</i> the packet contains a matching VLAN ID tag.	Edge profile
4. Group ID	Packet is learned on a port or link aggregate that is assigned to a matching group ID.	Edge profile
5. MAC address + VLAN tag	Packet contains a matching source MAC address <i>and</i> a matching VLAN ID tag.	All profiles
6. MAC address	Packet contains a matching source MAC address.	All profiles
7. MAC OUI + VLAN tag	Packet contains a source MAC address with a matching OUI and a matching VLAN ID tag.	Edge profile
8. MAC OUI	Packet contains a source MAC address with a matching OUI.	Edge profile
9. MAC address range + VLAN tag	Packet contains a source MAC address that falls within a specified range of MAC addresses <i>and</i> a matching VLAN ID tag.	All profiles
10. MAC address range	Packet contains a source MAC address that falls within a specified range of MAC addresses.	All profiles
11. LLDP for IP Phones	LLDP TLVs from an IP phone are detected.	Edge profile

Precedence Step/Rule	Matching Condition	Supported Profile
12. Authentication Type + VLAN tag	Packet received from a device authenticated through the matching authentication type <i>and</i> the packet contains a matching VLAN ID tag.	Edge profile
13. Authentication Type	Packet received from a device authenticated through the matching authentication type.	Edge profile
14. IP address + VLAN tag	Packet contains a matching source IP address <i>and</i> a matching VLAN ID tag.	All profiles
15. IP address	Packet contains a matching source IP address.	All profile
16. VLAN tag	Packet contains a matching VLAN ID tag.	All profiles

Binding Classification Rules for UNP Edge Profiles

Individual classification rules can be combined with other classification rules to create a binding rule. The following binding rule combinations are supported only with UNP Edge profiles and are listed in the order of precedence:

- 1 Port + MAC address + IP address + VLAN tag
- 2 Port + MAC address + VLAN tag
- 3 Port + IP address + VLAN tag
- 4 Group ID + MAC address + IP address + VLAN tag
- 5 Group ID + MAC address + VLAN tag
- 6 Group ID + IP address + VLAN tag

A device must match all the rules specified in the binding rule combination. For example, if a binding rule specifies a Port, MAC address, and IP address, then the device must have a matching port, source MAC address, *and* source IP address.

Note. Binding classification rules are only associated with UNP Edge profiles and take precedence over individual classification rules.

Extended Classification Rules for UNP Edge Profiles

An Extended classification rule defines a list of individual rules and assigns the list a name and a precedence value. A device must match all of the rules specified in the extended rule list.

The precedence value assigned to the extended rule's name is used to determine precedence among other extended classification rules configured on the switch. If a device matches all the criteria in two different extended rules, the rule with the highest precedence is applied to the device.

Although some individual classification rules can be combined to form a binding rule, a binding rule is not assigned a rule name and does not have a configurable precedence value. In addition, extended classification rules offer more rule combinations than binding rules.

Note. Extended classification rules are only associated with UNP Edge profiles and take precedence over all other UNP classification rule types (individual rules and binding rules).

For more information, see [“Configuring UNP Classification Rules”](#) on page 30-51.

How it Works

There is no global switch setting to invoke the UNP functionality. Instead, UNP is enabled on individual switch ports and profiles are defined to determine the dynamic VLAN assignment for devices connected through the UNP ports. When UNP is enabled on a switch port, the following device classification process is triggered when the port receives traffic.

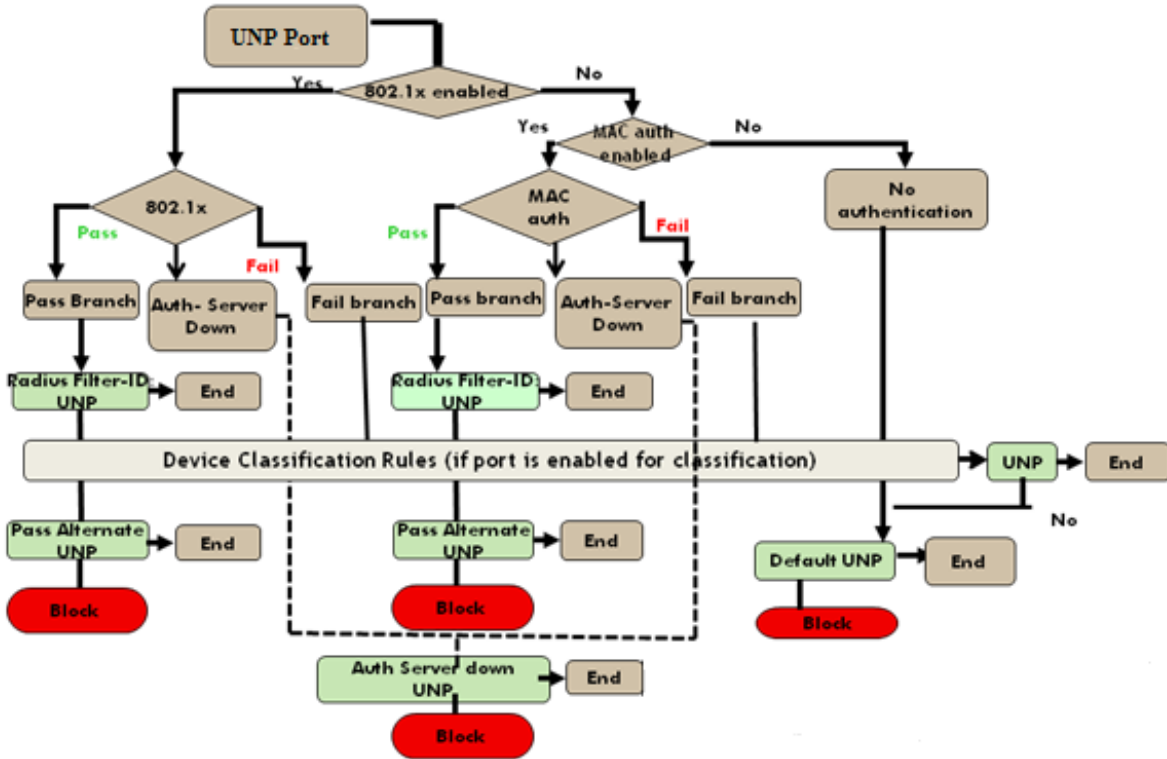

Interaction With Other Features

This section contains important information about how Universal Network Profile (UNP) functionality interacts with other OmniSwitch features. Refer to the specific chapter for each feature to get more detailed information about how to configure and use the feature.

Access Guardian

Access Guardian is a combination of authentication, device compliance, and access control functions that provide a *proactive* solution for network security. Implemented through the switch hardware and software, Access Guardian helps administrators:

- Determine who is on the network.
- Check if end users are compliant.
- Direct what end users can access within the network.

The OmniSwitch Access Guardian feature is configured and applied through the framework of the UNP feature. UNP is enabled on switch ports to activate the following Access Guardian functionality:

- Network access control and Quality of Service (QoS) on a per-user basis.
- Authentication and classification of devices into UNP Edge, VLAN, or Shortest Path Bridging (SPB) profiles.
- MAC-based and 802.1X-based authentication using a RADIUS-capable server.
- Switch-wide classification rules to classify users based on port and device attributes (for example, source MAC, Group ID, IP address). No authentication required.
- Default UNP classification for traffic not classified through other methods.
- Internal Captive Portal for Web-based authentication. Provides dynamic role change for the user device.
- Integration with ClearPass Policy Manager (CPPM) as part of the OmniSwitch Bring Your Own Device (BYOD) network access solution.

See [Chapter 31, “Configuring Access Guardian,”](#) for more information.

Learned Port Security

The UNP and Learned Port Security (LPS) features are supported on the same port with the following conditions:

- LPS is not supported on link aggregates.
- The LPS learning window is set globally but not on a per-port basis. So the window is applied to all UNP ports.
- When LPS is enabled or disabled on a UNP edge or bridge port (LPS is not supported on UNP access ports), MAC addresses already learned on that port are flushed.
- Configuring a static MAC address is not allowed on a UNP port unless LPS is also enabled on the same port.

- When both LPS and UNP are enabled on the same port,
 - UNP first authenticates and classifies any MAC addresses received, then LPS rules are applied.
 - If a MAC address violates any of the LPS rules for the port, the address may get filtered or the port violated even if UNP initially determined the address was valid. In other words, LPS rules take precedence over UNP to determine if a MAC address is bridged or filtered on the port.
- If UNP classifies a MAC address as learning but LPS learns the address as filtering, an untagged packet will show as filtering in the default VLAN for the port and a tagged packet MAC will show as filtering in the specific tagged VLAN.
- When a MAC address is filtered by LPS, the **show unip edge-user** command will display “LPS-Blocked” as the classification source for that MAC address.

See [Chapter 34, “Configuring Learned Port Security,”](#) for more information.

Quality of Service (QoS)

The Universal Network Profile (UNP) feature provides the ability to assign a list of QoS policy rules to a profile. The rules contained in the list are applied to any device that is assigned to the UNP. Consider the following guidelines when configuring policy lists for user profiles:

- QoS policy rules and policy lists are configured using the QoS switch feature. Configuration of these items is required before the list is assigned to a UNP.
- Configuring QoS policy lists is not allowed if VLAN Stacking Services or if QoS inner VLAN or inner 802.1Q tag policies are configured for the switch.
- Only one QoS policy list per UNP is allowed, but multiple profiles can use the same UNP. Up to 32 policy lists (including the default list) are allowed per switch.
- A default QoS policy list always exists in the switch configuration. Any QoS policies that are not assigned to a profile belong to the default list, unless specified otherwise when the policy is created.
- If a QoS policy list is configured for a profile, only the policy rules in the list are applied to traffic from devices to which the profile was applied. Any default list policy rules are not applied in this case.
- If a QoS policy list is not specified for a profile, then any policies from the default list are applied to profile devices.
- If a policy rule is enabled, it is active for all policy lists to which it belongs. If one of the policy lists is disabled, the rule is still active for all the other lists.
- If a policy rule is disabled, it is no longer active in any policy list to which it belongs, even if the list is still enabled.

UNP Port Interaction with Other Features

Feature	UNP Port
802.1q	Not supported. Supported on untagged ports.
Ethernet OAM	Not supported.
Ethernet Services (VLAN Stacking)	Not supported.
ERP	Not supported.
Edge Virtual Bridging (EVB)	Not supported.
IPv6	Not supported.
Learned Port Security (LPS)	Supported (UNP is applied first then LPS if UNP classifies the MAC address in a forwarding state).
Link Aggregation	Supported.
Multiple VLAN Registration Protocol (MVRP)	Not supported.
Port Mirroring	Not supported on destination ports (MTP). Supported on source ports.
Port Monitoring	Supported
Port Mapping	Not supported on network ports. Supported on user ports.
Service Manager access and network ports.	Not supported.
Source Learning	Not supported on ports on which dynamic source learning or VLAN-level is disabled and disabling VLAN-level source learning is not recommended.
STP port enable or disable	Not supported.
Static MAC addresses	Supported only when LPS is also enabled on the port.

UNP Configuration Overview

There is no overall switch setting to invoke the UNP feature. Instead, UNP is enabled on individual switch ports and profiles are created with specific attributes to determine which UNP is applied to specific traffic received on that port.

Configuring the UNP feature consists of both profile-based and port-based configuration tasks. The profile-based tasks define profile attributes that enforce network access control for devices classified into the profile. The port-based tasks enable UNP functionality on individual ports. By default, UNP is disabled on all ports even if profiles exist in the switch configuration.

Profile Configuration Tasks

- Create an Edge, VLAN, or Shortest Path Bridging (SPB) profile. See [“Configuring Profiles” on page 30-43](#).
- Optionally assign a QoS policy list to the profile. See [“Configuring QoS Policy Lists” on page 30-50](#).
- Optionally configure classification rules for the profile. When classification is enabled on a UNP port, these rules are applied to traffic received on the port to determine which UNP is applied to the traffic. See [“Configuring UNP Classification Rules” on page 30-51](#).
- Enable or disable dynamic VLAN configuration of the VLANs associated with a VLAN classification profile. The status of dynamic VLAN configuration is applied to all VLAN profiles. See [“Enabling Dynamic VLAN Configuration” on page 30-46](#).
- Enable or disable dynamic configuration of VLAN classification profiles. A dynamic profile is created only when specific traffic conditions occur on UNP bridge ports. See [“Enabling Dynamic VLAN Profile Configuration” on page 30-47](#).
- Define a temporary UNP to which devices classified on UNP edge or bridge ports are assigned in the event the authentication server is down or unreachable. A configurable timer is also available to specify how long a device remains in this temporary UNP. See [“Configuring an Authentication Server Down UNP” on page 30-34](#).

Port Configuration Tasks

- Enable or disable UNP functionality on one or more switch ports. When UNP is enabled for a port, traffic received on that port is then subject to the UNP authentication and classification configuration. See [“Enabling UNP on Ports” on page 30-34](#).
- Configure UNP port parameters, such as the following:
 - 802.1X-based or MAC-based authentication.
 - An alternative UNP for 802.1X or MAC authentication. When authentication is successful but the RADIUS server does not return a UNP name, the alternate pass UNP is applied to the device traffic.
 - Rule-based classification. When classification is enabled, UNP rules are applied to device traffic if authentication fails or is not available.
 - A default profile. The default UNP is applied to traffic when other classification methods do not provide a profile name.
 - The trust tag option. Specifies whether the VLAN ID in the device packet is trusted. When enabled, packets carrying a VLAN ID tag that matches a VLAN configured on the switch are dynamically assigned to that VLAN.

See [“Configuring UNP Port Parameters” on page 30-35](#) for more information about configuring UNP port functionality.

Configuring UNP Port-Based Access Control

For port-based network access control, the switch must know which servers to use for authenticating supplicant (802.1X) and non-supplicant (non-802.1X) user devices.

In addition, UNP must be enabled on each port that is connected to a supplicant or non-supplicant device. Optional parameters can be set for each UNP port. Edge, VLAN, and SPB profiles define attributes used to enforce network access control on devices classified into the profile.

Enabling Authentication for the Switch

Use the **aaa device-authentication** command to specify which servers the switch will use for 802.1X, MAC, and Captive Portal authentication. The servers must already be configured through the **aaa radius-server** command. An example of setting the switch to use specific servers for 802.1X authentication:

```
-> aaa device-authentication 802.1x rad1 rad2
```

In this example, the **rad1** server is used for authenticating user devices connected to UNP ports on which 802.1X authentication is enabled. If **rad1** becomes unavailable, the switch then uses **rad2** for 802.1X authentication.

To set the switch to use specific servers for MAC authentication, use the **aaa device-authentication** command with the **mac** parameter. For example:

```
-> aaa device-authentication mac rad1 rad2
```

In this example, the **rad1** server is used for authenticating user devices connected to UNP ports on which MAC authentication is enabled. As in the 802.1X authentication example, if **rad1** becomes unavailable, the switch will then use **rad2** for MAC authentication.

To set the switch to use specific servers for internal Captive Portal authentication, use the **aaa device-authentication** command with the **captive-portal** parameter. For example:

```
-> aaa device-authentication captive-portal rad1 rad2
```

In this example, the **rad1** server is used for authenticating user devices connected to UNP ports that are classified into an Edge profile that has Captive Portal authentication enabled. As in the 802.1X and MAC authentication example, if **rad1** becomes unavailable, the switch will then use **rad2** for internal Captive Portal authentication.

Note. The same RADIUS servers can be used for 802.1x, MAC, and Captive Portal authentication. Using different servers for each type of authentication is allowed but not required. For more information about configuring authentication servers, see [Chapter 35, “AAA Commands.”](#)

For more information about authenticating and classifying devices on UNP ports, see [“Device Authentication and Classification” on page 30-25](#).

Configuring an Authentication Server Down UNP

An authentication server down UNP is used to classify devices attempting to authenticate through UNP ports when the RADIUS server is unreachable. By default, there is no such profile configured for the switch. To create this type of UNP, use the **unp auth-server-down** command.

```
-> unp auth-server-down edge-profile down_unp
```

After a device is classified into the VLAN for this UNP, an attempt to re-authenticate the device is made after a specific period of time (60 seconds by default). To change this time value, use the **unp auth-server-down timeout** command.

```
-> unp auth-server-down edge-profile timeout 120
```

Configuring an authentication server down UNP is highly recommended when MAC or 802.1X authentication is enabled on any UNP port or link aggregate. This is because after a switch reload, the traffic from devices connected to UNP ports and link aggregates reaches the switch and triggers the authentication process before route convergence has completed and the server can be reached.

- If an authentication server down UNP is configured, devices are temporarily learned in that profile and authentication is automatically attempted again after the timeout period expires. This allows time for the server to become reachable from the switch after a reload.
- If an authentication server down UNP is not configured, devices are learned as filtering and will remain in that state. There is no further attempt to authenticate these devices again.

The authentication down UNP and related timer value are applied to all traffic received on all UNP ports in the event the RADIUS server becomes unreachable. To verify if this setting is enabled or disabled, use the **show unp global configuration** command.

Note. When device authentication fails due to an unreachable RADIUS server, an event message is sent to the switch logging utility (swlog). See [Chapter 37, “Using Switch Logging,”](#) for more information.

Enabling UNP on Ports

By default, UNP is disabled on all switch ports and link aggregates. To enable UNP functionality on a port or link aggregate, use the **unp port** command.

```
-> unp port 1/1/3
-> unp linkagg 10
```

There are three UNP port types supported: edge, bridge, and SPB access. When UNP is initially enabled, the port type is set to “edge” by default. To enable UNP and specify a port type, use the **unp port** command with the **port-type** parameter. For example:

```
-> unp port 1/1/12 port-type bridge
-> unp linkagg 5 port-type bridge
-> unp port 1/1/13 port-type spb-access
```

To remove the UNP configuration from a port or link aggregate, use the **no** form of the **unp port** command. For example:

```
-> no unp port 1/1/3
-> no unp linkagg 10
```

To change the port type of an existing UNP port, remove the current UNP configuration using the **no unport** or **no unport linkagg** command then use the **unport port-type** command to set the new port type. For example:

```
-> no unport 1/12
-> unport 1/12 port-type bridge
-> no unport linkagg 5
-> unport linkagg 5 port-type bridge
```

Configuring UNP Port Parameters

Enabling UNP functionality on a switch port does not automatically enable authentication and classification for traffic on that port. Configuration of additional port parameters is required to define the device authentication and classification options that the switch will apply to traffic received on the UNP port.

The configuration of UNP port parameters described in this section is only allowed on UNP-enabled switch ports. Make sure UNP is enabled first before attempting to configure any UNP port parameters.

Note. Any configuration change to a UNP-enabled port will flush all MAC addresses learned on that port. This applies only to CLI commands used to configure UNP port parameters.

When UNP is enabled on a port without specifying a port type, the port type is set to “Edge” by default and all traffic is blocked on the port until a UNP port-based configuration is defined. The following table lists all the UNP commands that are used to configure UNP port parameters for the specified type of UNP port. For example:

- The 802.1x and MAC authentication parameters are configurable for all UNP port types (edge, bridge, and SPB), so the “Port Type” field contains “All ports” for these parameters.
- The redirect port bounce parameter is only configurable for a UNP edge port, so the “Port Type” field contains “Edge port” for this parameter.

Command	Description	Port Type
unport redirect port-bounce	Configures the redirect port bounce status for the port. When enabled, a port bounce is triggered upon receipt of Change of Authorization (CoA) or Disconnect request (DM) messages.	Edge port
unport 802.1x-authentication	Configures the status of 802.1X authentication for the UNP port.	All ports
unport 802.1x-authentication pass-alternate	Assigns the name of an existing UNP as an alternate profile. If successful 802.1X authentication does not return a UNP, the device can be classified into this alternate profile.	All ports
unport 802.1x-authentication bypass	Configures whether to bypass 802.1X authentication on the port.	All ports
unport 802.1x-authentication failure-policy	Configures whether to attempt MAC authentication if 802.1X authentication fails or let the port configuration classify the device.	All ports

unp 802.1x-authentication tx-period	Configures the re-transmission time interval for UNP ports on which 802.1X authentication is enabled.	All ports
unp 802.1x-authentication supp-timeout	Configures the amount of time the switch will wait before timing out an 802.1X user attempting to authenticate through the port.	All ports
unp 802.1x-authentication max-req	Configures the maximum number of times the switch will transmit a request for authentication information to an 802.1X user on the port.	All ports
unp mac-authentication allow-eap	Configures whether to attempt 802.1X authentication after MAC authentication passes or fails on a UNP port that has 802.1X bypass enabled.	All ports
unp mac-authentication	Configures the status of MAC authentication for the UNP port.	All ports
unp mac-authentication pass-alternate	Assigns the name of an existing UNP as an alternate profile. If successful MAC authentication does not return a UNP, the device can be classified into this alternate profile.	All ports
unp classification	Configures the status of device classification for the UNP port. When enabled, UNP port and rule classification parameters are applied if device authentication does not provide a UNP name for a device connected to the port.	All port types
unp default-edge-profile unp default-vlan-profile unp default-spb-profile	Assigns the name of an existing UNP as the default profile for the UNP port. If device authentication or classification does not provide a UNP name for a user device, the device can be classified into the default profile.	Edge port Bridge port SPB port
unp port group-id	Assigns a UNP port to a numerical group ID. All UNP ports assigned to the same group ID represent a logical group domain to which specific UNP configuration and classification can be applied.	Edge port
unp unp-customer-domain	Assigns a UNP port to a numerical customer domain ID. Groups UNP ports together in a logical group. Similar to the group ID assignment for Edge ports.	Bridge port SPB port
unp aaa-profile	Assigns the name of an existing AAA configuration profile to a UNP port.	Edge port
unp port edge-template	Assigns the name of an Edge port template to the UNP port. This type of template applies a pre-defined configuration to the port. All of the other commands specified in this table are configurable parameters for the Edge port template.	Edge port
unp direction	Configures whether egress broadcast, unknown unicast, or multicast traffic is allowed on the UNP port.	Edge port Bridge port
unp trust-tag	Configures the option of whether to trust the VLAN ID of a tagged packet to determine how the packet is classified.	All ports

unp vlan	Configures an untagged VLAN-port association between the specified UNP port and VLAN ID.	All ports
-----------------	--	-----------

Consider the following guidelines when configuring UNP port parameters:

- The UNP profile name specified with the **unp default-edge-profile**, **unp default-vlan-profile**, **unp default-spb-profile**, **unp 802.1x-authentication pass-alternate**, and **unp mac-authentication pass-alternate** commands must already exist in the switch configuration. See [“Configuring Profiles” on page 30-43](#) for more information.
- The AAA profile configuration applied to a UNP port overrides the global AAA configuration for the switch. See [“Using AAA Configuration Profiles” on page 31-26](#) section in [Chapter 31, “Configuring Access Guardian,”](#) for more information.
- When an Edge template is assigned to a UNP Edge port, the parameter values defined in the template will override any existing UNP port configuration. In addition, any attempt to explicitly configure a port that is associated with a template is not allowed.
- Enabling both 802.1X and MAC authentication is allowed on the same port, but 802.1X authentication is attempted first unless 802.1X authentication bypass is also enabled for the port. See [“Configuring 802.1x Authentication Bypass” on page 31-31](#) in [Chapter 31, “Configuring Access Guardian,”](#) for more information.
- If there is no authentication type enabled for the UNP port, then the source MAC address of a device connected to the port is not sent to the designated RADIUS server for identification and authentication. Instead, other classification parameters configured for the port are applied first

Using Edge Port Templates

A UNP Edge port template is a configuration entity that provides flexible assignment of a pre-defined UNP port configuration to specific edge ports. Using an Edge port template to configure UNP functionality on a port or link aggregate avoids having to configure each parameter with a separate CLI command. Applying an Edge template configures all port-based parameters with a single CLI command.

A UNP Edge port template is used to define and apply the following UNP port configuration settings:

- The type of device authentication (802.1X or MAC) to enable on the port.
- Specific 802.1X parameters, such as re-transmission interval, supplicant timeout, or maximum number of times to request authentication information from an 802.1X user.
- 802.1X authentication bypass.
- 802.1X authentication after MAC authentication passes or fails on a UNP port that has 802.1X bypass enabled.
- An 802.1X failure policy to determine if MAC authentication or classification is attempted after 802.1X authentication fails.
- Device classification status to determine if UNP classification rules are used to select an Edge profile.
- A default UNP Edge profile.
- An alternate UNP Edge profile for when successful 802.1X or MAC authentication does not return a UNP name.
- The name of an AAA configuration profile to assign to the port.

- BYOD redirect port bounce status.
- The ID of a logical group of ports to which the port is assigned.
- Trust tag status.
- VLAN IDs used to create an untagged VLAN-port-association with the port.

Configuring Edge Port Templates

Use the **unp edge-template** command to create a template name and configure parameter values for the template. For example:

```
-> unp edge-template et-1
-> unp edge-template et-1 mac-authentication enable
-> unp edge-template et-1 mac-authentication pass-alternate edge-profile edge1
-> unp edge-template et-1 classification enable
-> no unp edge-template et-1

-> unp edge-template et-2 802.1x-authentication enable
-> unp edge-template et-2 classification enable
-> unp edge-template group-id 10
-> no unp edge-template et-2
```

Use the **unp port edge-template** command to assign an AAA profile to a UNP port or UNP link aggregate. For example:

```
-> unp port 1/1/5 edge-template up1
-> unp port 1/2/1-5 edge-template up2
-> unp linkagg 10 edge-template up3
-> unp linkagg 10-50 edge-template up4
```

Use the **show unp edge-template** command to display the UNP Edge port template configuration.

For more information about the commands described in this section, see the *OmniSwitch AOS Release 8 CLI Reference Guide*.

Configuring 802.1x Authentication Bypass

When a device is connected to a UNP port with 802.1X authentication and MAC authentication enabled, the switch first attempts to identify and authenticate the device using EAP frames. If the device does not respond to EAP frames sent by the switch after a configurable number of attempts, then the device is identified as a non-suppliant and undergoes MAC authentication.

In some cases, however, the network administrator may want to apply MAC authentication first to all devices (suppliant or non-suppliant) connected to the UNP port. In other words, the switch does not initiate 802.1x authentication; EAP frames are not sent and any received are ignored.

The advantage to applying MAC authentication first is that the MAC address of the device is initially verified (for example, checked against a RADIUS black list). Based on the outcome of the MAC authentication, the user device is then classified accordingly or can undergo subsequent 802.1x authentication.

To enforce MAC authentication as the initial authentication method for all devices connected to a UNP port, an 802.1x bypass operation is provided. In addition, the bypass operation provides configurable options that are used to specify if subsequent 802.1x authentication is performed on the device based on the results of MAC authentication.

Configuring 802.1x authentication bypass is done using the **unp 802.1x-authentication bypass** and **unp mac-authentication allow-eap** commands. The **unp 802.1x-authentication bypass** command enables or disables the bypass operation. The following **unp mac-authentication allow-eap** command parameters determine if subsequent 802.1x authentication is attempted on the device after MAC authentication:

- **pass**—802.1x authentication is attempted if the device passes the initial MAC authentication. If the device fails MAC authentication, 802.1x authentication is bypassed (EAP frames are ignored) and the device is classified as a non-suppliant.
- **fail**—802.1x authentication is attempted if the device fails the initial MAC authentication. If the device passes MAC authentication, 802.1x authentication is bypassed (EAP frames are ignored) and the device is classified as a non-suppliant.
- **noauth**—802.1x authentication is automatically attempted if there is no MAC authentication available for the port.
- **none** (the default)—802.1x authentication is permanently bypassed. Only MAC authentication is performed and the device is classified as a non-suppliant.

Configuration Guidelines

Consider the following guidelines before configuring 802.1x authentication bypass:

- The 802.1x bypass operation is only supported on UNP ports with 802.1x authentication enabled. See [“Configuring UNP Port Parameters” on page 30-35](#) for more information about configuring the access control mode.
- If a port has supplicants connected and 802.1x bypass is enabled for that port, the supplicants are automatically logged off to undergo authentication according to the enabled bypass configuration.
- When the 802.1x bypass configuration is modified or disabled, any non-suppliant devices are automatically logged off the port. This will free up those devices to undergo the authentication specified by the new bypass configuration.
- If re-authentication is configured for the UNP port and 802.1X bypass is enabled, the MAC authentication followed by 802.1x authentication is initially performed as configured. However, only 802.1x authentication is performed during the re-authentication process, so there is no recheck to see if the MAC address of the user device is restricted.
- Enabling 802.1X bypass is not allowed on UNP ports that are configured with an 8021X failure policy.
- When successful MAC authentication returns a UNP and the 802.1x bypass operation is configured to initiate 802.1x authentication when a device passes MAC authentication, the device is *not* moved into that UNP. Instead, the device is moved into the UNP returned by 802.1x authentication. If 802.1x authentication does not provide such information, the device is moved based on the UNP port-based configuration.
- When 802.1X bypass is enabled and after MAC authentication, the port will be in a waiting state until the 802.1X authentication process complete.

Configuration Example: 802.1X Bypass with MAC Authentication Fail Policy

The following CLI configuration example enables 802.1x authentication bypass on port 2/1 and triggers subsequent 802.1X authentication if the initial MAC authentication process fails:

```
-> unp port 2/1 802.1x-authentication bypass enable
-> unp port 2/1 mac-authentication allow-eap fail
```

The resulting Access Guardian authentication process for a device connected to UNP port 2/1 is as follows for this example:

- MAC authentication is triggered when the first frame from the new user is received, whether it is an EAP frame or not.
- EAP frames for this user are ignored until MAC authentication completes (RADIUS returns an Access-Accept or a Access-Reject response).
- If the initial MAC authentication passes (that is, Access-Accept), 802.1x authentication is bypassed for this user and all EAP frames are ignored.
- If the initial MAC authentication fails (that is, Access-Reject), 802.1x authentication is attempted for the user. During this transition, the EAP frames are allowed and the switch must force the supplicant to restart a fresh EAP session by sending a multicast Request Identity EAPOL on the port. This is because the supplicant may have already sent an EAPOL Start.

Configuring UNP Port Bandwidth

The following two methods are available to configure and apply port bandwidth parameter values to UNP ports that are assigned to a profile:

- **QoS policy list rules.** A QoS policy list assigned to an Edge, VLAN, or SPB profile applies policy rules to all traffic that is classified into the profile associated with the policy list. For example, the following commands create a QoS policy list with rules to apply rate limiting parameters to all device ports assigned to the “UNP-1” Edge profile:

```
-> policy condition ip_traffic2 source ip 10.10.5.3
-> policy action flowShape maximum bandwidth 10m
-> policy action burst maximum depth 1m
-> policy rule rule2 condition traffic2 action flowShape action burst
-> policy list rate-limit type unp
-> policy list rate-limit rules rule2
-> unp edge-profile UNP-1
-> unp edge-profile UNP-1 qos-policy-list rate-limit
-> unp vlan-mapping 50
```

See [“Configuring QoS Policy Lists” on page 30-50](#) for more information.

- **Profile bandwidth parameters.** Configurable bandwidth parameter values associated with an Edge or VLAN profile (not configurable for an SPB profile) are applied to traffic that is classified into the Edge or VLAN profile. For example, the following commands define profile bandwidth parameters to rate limit traffic on all device ports assigned to the “UNP-1” Edge profile.

```
-> unp edge-profile UNP-1 maximum-ingress-bandwidth 10M
-> unp edge-profile UNP-1 maximum-egress-bandwidth 10M
-> unp edge-profile unp-1 maximum-ingress-depth 1
-> unp edge-profile unp-1 maximum-egress-depth 1
```

See [“Configuring Profiles” on page 30-43](#) for more information.

Consider the following guidelines when configuring UNP port bandwidth:

- The maximum ingress and egress bandwidth values are configured in Kbps or Mbps.
- The maximum ingress and egress depth values are configured in Kbps.
- The default value for the maximum ingress and egress depth settings is calculated by dividing the maximum ingress or egress bandwidth value by 25. For example, if the ingress bandwidth value is set

to 500K, then the ingress depth value defaults to 20K ($500K/25=20K$). However, if this calculation results in a value of 0 or 1, then the default value is set to 2K.

- “Per user” bandwidth profiling is not supported. If there are multiple users authenticating through a port, then the bandwidth limitation of the last user overrides the existing bandwidth limitations, if any.
- Runtime modification of UNP ingress or egress bandwidth is allowed; the modified values are then applied to both new and already authenticated user devices learned on the profile. The new runtime values become the latest bandwidth values for the profile, so they are applied to all user devices associated with the profile.
- The bandwidth limitation applied on a port through UNP classification is not removed when a user logs out or ages out. An administrator can override the bandwidth limitation through the **qos port** command or by removing the UNP configuration on the port.
- If any port bandwidth parameter value defined for a UNP profile is modified, then the other parameters need to be configured again, otherwise they will be set to their default values. For example, consider a UNP profile with maximum egress bandwidth set to 100M and egress depth set to 10K, where the maximum bandwidth is changed to 200M. In this scenario, only the modified maximum bandwidth is considered, but the egress depth is reset to the default value unless the required value is specifically configured again.
- If port bandwidth values are applied through UNP profile (Edge or VLAN) bandwidth parameters *and* also through a QoS policy list associated with the same profile, then the minimum of both the values is applied on the UNP port.

Multiple User Authentication on the Same Port

If multiple users are authenticated through the same UNP port and are classified with either RADIUS returned attributes or through locally configured classification methods, then the bandwidth associated to the latest authenticated user will override the previous bandwidth associated. If there is no bandwidth associated to the new user, then no rate limitations are enforced and previously set bandwidth is applied to the new authenticated user.

There is no priority between bandwidth limits provided through the **qos port** command or UNP. The latest change will over write the previous bandwidth limitation applied on the port. For example:

Bandwidth Profile	Action
If a user authenticates into a UNP with no UNP bandwidth profile (no bandwidth parameters or QoS policy list to apply rate limitations).	The port bandwidth setting is applied.
If a user authenticates into a UNP with a bandwidth profile (bandwidth parameters or QoS policy list applies rate limitations).	The UNP bandwidth setting overrides the port bandwidth setting.

Note. The same bandwidth behavior applies when the user is authenticated with QoS port bandwidth, QoS port configuration being the latest configuration.

Configuring UNP Port Domains

UNP port domains provide an additional method for segregating device traffic. A domain is identified by a numerical ID, which can be assigned to UNP ports and profile classification rules. By default, all UNP ports and profile rules are assigned to domain 0.

The main benefit of UNP port domains is that they provide the ability to group physical UNP ports or link aggregates into one logical domain. Once a UNP port is assigned to a specific domain ID, only classification rules associated with the same domain ID are applied to that port.

An example of using UNP port domains would be to group UNP ports carrying traffic for a specific customer into the same domain (all Customer A ports are assigned to domain 2). Then assign profiles tailored for that customer to the same domain ID (all profiles for Customer A are assigned to domain 2).

There are two types of domain IDs: a group ID and a customer domain ID. The type of domain ID to use is based on the port and profile type to which the ID is assigned. For example:

- UNP edge ports and profiles are assigned to group IDs.
- UNP bridge ports and VLAN profiles are assigned to customer domain IDs.
- UNP SPB access ports and profiles are also assigned to customer domain IDs.

By default, all UNP edge ports are assigned to group 0 and all UNP bridge and SPB access ports are assigned to customer domain 0. To add additional group or customer domain IDs, use the **unp group-id** command or the **unp customer-domain** command. For example:

```
-> unp group-id 2
-> unp customer-domain 2
```

To assign UNP edge ports to a group ID, use the **unp port group-id** command. For example:

```
-> unp port 1/1/1-3 group-id 2
-> unp linkagg 5 group-id 52
```

To assign UNP bridge or SPB access ports to a customer domain ID, use the **unp unp-customer-domain** command. For example:

```
-> unp port 1/1-3 unp-customer-domain 2
-> unp linkagg 5 unp-customer-domain 5
```

See [“Configuring Classification Rules for UNP Port Domains”](#) on page 30-51 for more information.

Configuring Profiles

Universal Network Profiles (UNP) are assigned to host devices through the device authentication process, the application of profile classification rules, or based on the UNP port configuration. There are three types of profiles supported: Edge, VLAN, and Shortest Path Bridging (SPB). The type of profile applied to port traffic is based on the port type. For example:

- Edge profiles classify traffic received on UNP edge ports.
- VLAN profiles classify traffic received on UNP bridge ports.
- SPB service profiles classify traffic received on UNP access ports.

This section provides information about how to configure UNP Edge, VLAN, and SPB profiles.

Configuring a UNP Edge Profile

The following **unp edge-profile** commands are used to create a UNP Edge profile and configure profile attributes that are used to enforce network access control for devices assigned to the profile:

Command	Description
unp edge-profile	Creates an Edge profile and associates the profile with a name.
unp edge-profile qos-policy-list	Assigns a QoS policy list to an Edge profile. If there is no list assigned to a profile, users classified into that profile are granted full access within the profile VLAN domain.
unp edge-profile location-policy	Assigns the name of a location-based policy to the Edge profile. This type of policy defines criteria (such as the slot/port, system name and location) to determine if a device is accessing the network from a valid location.
unp edge-profile period-policy	Assigns the name of a time-based policy to the Edge profile. This type of policy specifies the days and times during which a device can access the network.
unp edge-profile captive-portal-authentication	Configures the status of internal Captive Portal authentication for the profile. When enabled, triggers the Captive Portal authentication process for users classified into the profile.
unp edge-profile captive-portal-profile	Assigns the name of a Captive Portal profile that applies a specific Captive Portal configuration to devices assigned to the Edge profile. This type of profile is applied when Captive Portal is enabled for the Edge profile and overrides the global Captive Portal configuration.
unp edge-profile authentication-flag	Configures the status of the authentication flag for the profile. When enabled, only devices that were successfully authenticated are allowed into the Edge profile.
unp edge-profile mobile-tag	Configures the mobile tagging status for the profile. When enabled, the UNP port to which a device is connected is tagged with the VLAN ID associated with the Edge profile when the device is classified into that profile.
unp edge-profile redirect	Configures the redirect status for the profile. When enabled, the profile honors Change of Authorization (CoA) and Disconnect request (DM) messages to interact with the ClearPass Policy Manager (CPPM) as part of the OmniSwitch BYOD solution.

unp edge-profile maximum-ingress-bandwidth	Configures the maximum amount of bandwidth allocated for ingress traffic on UNP bridge ports assigned to the Edge profile.
unp edge-profile maximum-egress-bandwidth	Configures the maximum amount of bandwidth allocated for egress traffic on UNP bridge ports assigned to the Edge profile.
unp edge-profile maximum-ingress-depth	Configures how much traffic is allowed to burst over the maximum ingress bandwidth limit on UNP bridge ports assigned to the Edge profile.
unp edge-profile maximum-egress-depth	Configures how much traffic is allowed to burst over the maximum egress bandwidth limit on UNP bridge ports assigned to the Edge profile.
unp vlan-mapping edge-profile	Maps a VLAN ID to an Edge profile. Devices classified into the Edge profile are dynamically assigned into the VLAN associated with the profile.

Consider the following guidelines when configuring UNP Edge profiles:

- Any Edge profile names that will be assigned through RADIUS authentication must be defined on both the OmniSwitch and the RADIUS server.
- Edge profile attributes are only applied to device traffic that is received on UNP-enabled edge ports (see [“Enabling UNP on Ports” on page 30-34](#)).
- The QoS rules within a policy list are applied to all members of the Edge profile group to enforce access to network resources. Only one policy list is allowed per profile, but multiple profiles may use the same policy list. See [“Configuring QoS Policy Lists” on page 30-50](#) for more information.
- If a device violates a location or time period policy, the device is placed into an unauthorized state, even though it is still assigned to the profile. In this state, a built in QoS policy list is applied to the device to restrict the role of the device.
- Captive Portal authentication is applied as a post-authentication and/or post-classification mechanism to devices assigned to the Edge profile. Captive Portal provides a Web-based authentication mechanism to dynamically change the role-based access (policy list) for a user. See [“Using Captive Portal Authentication” on page 31-48](#) in [Chapter 31](#), [“Configuring Access Guardian,”](#) for more information.
- Enabling internal Captive Portal authentication is not allowed on profiles with the redirect flag enabled. When the redirect flag is enabled, external Captive Portal authentication is triggered for the device.
- To ensure proper redirection for devices classified into a redirect Edge profile (redirect flag is enabled), configure the redirection server as the preferred server through AAA commands for MAC and 802.1X authentication. See [“Bring Your Own Devices \(BYOD\) Overview” on page 31-77](#) in [Chapter 31](#), [“Configuring Access Guardian,”](#) for more information.
- UNP classification rules can also be defined for a UNP Edge profile to provide an additional method for classifying a device into an Edge profile. If authentication is not available or does not return a profile name, classification rules are applied to determine the profile assignment. See [“Configuring UNP Classification Rules” on page 30-51](#) for more information.
- A UNP Edge profile can be configured as a default profile for a UNP edge port. If authentication and classification do not return a profile name, the device is then assigned to the default Edge profile associated with the edge port on which the device was learned. See [“Configuring UNP Port Parameters” on page 30-35](#).

To configure a UNP Edge profile, use the **unp edge-profile** commands and the **unp vlan-mapping edge-profile** command. For example, the following command creates the “guest_user” profile to assign devices to VLAN 500 and apply the rules from the “temp_rules” policy list:

```
-> unp edge-profile guest_user
-> unp edge-profile qos-policy-list temp_rules
-> unp vlan-mapping edge-profile guest_user vlan 500
```

To verify the UNP configuration for the switch, use the **show unp edge-profile** command. For more information about profiles, see “Profile Types” on page 30-20.

For more information about the **unp** commands described in this section, see the “UNP Commands” chapter in the *OmniSwitch AOS Release 8 CLI Reference Guide*.

Configuring a UNP VLAN Profile

The following **unp vlan-profile** commands are used to create a UNP VLAN profile and configure profile attributes that are used to enforce network access control for devices assigned to the profile:

Command	Description
unp vlan-profile	Creates a VLAN profile and associates the profile with a name and VLAN ID.
unp vlan-profile qos-policy-list	Assigns a QoS policy list to a VLAN profile. If there is no list assigned to a profile, users classified into that profile are granted full access within the profile VLAN domain.
unp vlan-profile mobile-tag	Configures the mobile tagging status for the profile. When enabled, the UNP port to which a device is connected is tagged with the VLAN ID associated with the VLAN profile when the device is classified into that profile.
unp vlan-profile maximum-ingress-bandwidth	Configures the maximum amount of bandwidth allocated for ingress traffic on UNP bridge ports assigned to the VLAN profile.
unp vlan-profile maximum-egress-bandwidth	Configures the maximum amount of bandwidth allocated for egress traffic on UNP bridge ports assigned to the VLAN profile.
unp vlan-profile maximum-ingress-depth	Configures how much traffic is allowed to burst over the maximum ingress bandwidth limit on UNP bridge ports assigned to the VLAN profile.
unp vlan-profile maximum-egress-depth	Configures how much traffic is allowed to burst over the maximum egress bandwidth limit on UNP bridge ports assigned to the VLAN profile.

Consider the following when configuring a VLAN profile:

- The VLAN associated with a profile must already exist in the switch configuration, unless the dynamic VLAN configuration functionality is enabled (see “Enabling Dynamic VLAN Configuration” on page 30-46).
- VLAN profile attributes are only applied to device traffic that is received on UNP-enabled bridge ports (see “Enabling UNP on Ports” on page 30-34).
- If a standard VLAN ID associated with a VLAN profile is deleted, the profile association with that VLAN ID is still maintained. Any traffic subsequently classified with this profile is filtered unless the

UNP port on which the traffic is received is configured with alternate classification methods (see [“Configuring UNP Port Parameters” on page 30-35](#)).

- Specifying a QoS policy list name that is inactive or does not already exist in the switch configuration is allowed. However, the list will remain inactive for the UNP until the list is enabled or configured using the QoS policy list commands (see [“Configuring QoS Policy Lists” on page 30-50](#)).
- A UNP VLAN profile can be configured as a default profile for a UNP bridge port. If authentication and classification do not return a profile name, the device is then assigned to the default VLAN profile associated with the bridge port on which the device was learned. See [“Configuring UNP Port Parameters” on page 30-35](#).

To configure a UNP VLAN profile, use the **unp vlan-profile** command. For example, the following command creates the “guest_user” profile to assign devices to VLAN 500 and applies the rules from the “temp_rules” policy list:

```
-> unp vlan-profile guest_user vlan 500 qos-policy-list temp_rules
```

To verify the VLAN profile configuration for the switch, use the **show unp vlan-profile** command. For more information about profiles, see [“Configuring Profiles” on page 30-43](#).

For more information about the **unp** commands described in this section, see the “UNP Commands” chapter in the *OmniSwitch AOS Release 8 CLI Reference Guide*.

Enabling Dynamic VLAN Configuration

When creating a UNP VLAN profile, it is possible to specify the VLAN ID of a VLAN that does not exist in the switch configuration. The UNP feature provides the ability to enable dynamic VLAN configuration, which allows “on the fly” configuration of VLANs as they are needed.

When dynamic VLAN configuration is enabled and a profile is created with a VLAN that does not exist, UNP will create that VLAN at the time the profile is created. By default, dynamic VLAN configuration is disabled for the switch. To enable this functionality, use the **unp dynamic-vlan-configuration** command.

```
-> unp dynamic-vlan-configuration enable
```

Use the **disable** option with the **dynamic-vlan-configuration** command to disable dynamic configuration.

```
-> unp dynamic-vlan-configuration disable
```

Dynamic VLAN configuration is a global UNP setting that applies to all profiles. To verify if this setting is enabled or disabled, use the **show unp global configuration** command.

Consider the following when enabling dynamic VLAN configuration:

- The VLAN status and other port (non-UNP port) assignments are configurable using standard VLAN commands. In addition, the STP status of the VLAN is configurable and enabled by default when the dynamic VLAN is created.
- A dynamic VLAN cannot be deleted using standard VLAN commands (**no vlan *vlan_id***).
- UNP dynamic VLANs are identified as a separate type of VLAN. The **vlan show** commands will display this type with the default name of “UNP-DYN-VLAN” and the designated type as “UNP Dynamic Vlan”. For example:

```
-> show vlan 450
Name                : UNP-DYN-VLAN,
Type                : UNP Dynamic Vlan,
Administrative State : enabled,
Operational State   : disabled,
```

```
IP Router Port      : disabled,
IP MTU              : 1500
```

- Dynamic VLANs are not saved in the “! VLAN:” section of the switch configuration file (**boot.cfg**). However, the **unp** commands to enable dynamic VLAN configuration and create the UNP are saved in the “! DA-UNP:” section of **boot.cfg** (see the following sample **boot.cfg** file). As a result, the VLAN is created again on the next switch bootup.

```
-> show configuration snapshot vlan
! VLAN:
vlan 1 admin-state enable
vlan 451 admin-state enable
vlan 777 admin-state enable
vlan 887-888 admin-state enable

-> show configuration snapshot da
! DA-UNP:
unp dynamic-vlan-configuration enable
unp vlan-profile templ vlan 450
unp vlan-profile unpTemp vlan 10
unp vlan-profile unpTemp2 vlan 10
unp classification mac-address 00:00:00:00:00:01 vlan-profile unpTemp2
unp classification mac-address 10:22:33:44:55:66 vlan-profile unpTemp2
unp classification ip-address 1.1.1.2 mask 255.0.0.0 vlan-profile unpTemp2
unp port 1/1/11 port-type bridge
unp port 1/1/11 802.lx-authentication enable
unp port 1/1/11 classification enable
unp port 1/1/12 port-type bridge
unp port 1/1/12 mac-authentication enable
unp port 1/1/12 classification enable
```

Enabling Dynamic VLAN Profile Configuration

The UNP feature provides the ability to enable dynamic VLAN profile configuration, which allows “on the fly” configuration of profiles when specific traffic conditions occur. By default, dynamic profile configuration is disabled for the switch. To enable this functionality, use the **unp dynamic-profile-configuration** command. For example:

```
-> unp dynamic-profile-configuration enable
```

Use the **disable** option with the **dynamic-profile-configuration** command to disable this functionality. For example:

```
-> unp dynamic-profile-configuration disable
```

Dynamic profile configuration is a global UNP setting that is applied to traffic on any UNP bridge port that is configured to trust the VLAN tag of the incoming packets. To verify if this setting is enabled or disabled, use the **show unp global configuration** command.

Consider the following when enabling dynamic profile configuration:

- A profile is only dynamically created if the trust VLAN tag is enabled for the UNP bridge port and the packet VLAN tag matches an MVRP VLAN ID that is not assigned to a UNP or there is no matching VLAN ID in the switch configuration.
- Dynamically created profiles are saved in the **boot.cfg** file for the switch.
- By default, dynamically created VLAN profiles are automatically named **dynamic_profile_vlan_id**, where the VLAN ID is the ID of the VLAN contained in the packet tag.

- After the dynamic profile is created, changing the VLAN profile name, associated VLAN ID, or the QoS policy list is allowed. To avoid any confusion, change the profile name if the VLAN ID associated with the profile has changed.
- When the dynamic profile configuration option is enabled along with the dynamic VLAN configuration option, if the dynamically created profile refers to a VLAN that is an MVRP VLAN, then the MVRP VLAN is automatically converted to a dynamic UNP VLAN (UNP-DYN-VLAN).

Configuring a UNP SPB Profile

The following **unp spb-profile** commands are used to create a UNP Shortest Path Bridging (SPB) service-based profile and configure profile attributes that are used to enforce network access control for devices assigned to the profile:

Command	Description
unp spb-profile	Creates an SPB profile and associates the profile with a name, a VLAN tag value, a Service Instance ID (I-SID), and a Backbone VLAN (BVLAN) ID. The VLAN tag, I-SID, and BVLAN values are used to define a Service Access Point (SAP) for profile traffic.
unp spb-profile qos-policy-list	Assigns a QoS policy list to an SPB profile. If there is no list assigned to a profile, users classified into that profile are granted full access within the profile service domain.
unp spb-profile multicast-mode	Configures the multicast replication mode (head-end or tandem) for the SPB service that is associated with the SPB profile. The multicast mode determines how non-unicast packets are replicated through the SPB backbone network.
unp spb-profile vlan-xlation	Configures the status of VLAN translation for egress traffic associated with the SPB profile. When enabled, the VLAN tags for profile traffic are processed according to the settings for the SAP on which the frames will egress, not according to the settings for the SAP on which the frames were received.
unp spb-profile mobile-tag	Configures the mobile tagging status for the profile. When enabled, the UNP port to which a device is connected is tagged with the BVLAN ID associated with the SPB profile when the device is classified into that profile.

Consider the following when configuring an SPB service-based profile:

- SPB profile attributes define a SAP for device traffic received on UNP-enabled SPB access ports (see [“Enabling UNP on Ports” on page 30-34](#)).
- The VLAN tag value indicates whether the VLAN tag information from the classified packets is used to assign the traffic to a SAP or if specific single or double-tag values are used to assign the traffic to a SAP. Specify one of the following VLAN tag values for the profile:

0 (zero)	The VLAN tag of the packet is used to determine the SAP encapsulation value. Setting the profile tag value to zero has the same result as enabling trust VLAN tag for the UNP SPB access port.
Outer VLAN tag	The outer VLAN tag value to use for the SAP encapsulation value.

Inner and outer VLAN tags The inner and outer VLAN tag values to use for the SAP encapsulation value.

- If classified traffic is untagged, then zero is used for the SAP encapsulation value (for example, 1/2:0).
- If the I-SID value specified does not exist in the switch configuration, the service is dynamically created first then the SAP is dynamically created and associated with this service.
- The BVLAN associated with an SPB service profile must already exist in the switch configuration.
- If the VLAN tag value of the classified traffic does not match the tag value specified in the profile, UNP will check to see if the trust VLAN tag option is enabled for the UNP SPB access port. If so, a SAP is assigned using the VLAN tag values of the traffic. If not, the traffic is learned as filtering on the UNP port.
- The default setting for the SPB multicast mode is the head-end mode.
 - When the head-end multicast mode is used, a non-unicast packet received on an SPB access port is replicated once for each receiver in the provider backbone bridge (PBB) network using its unicast base MAC (BMAC) address.
 - When the tandem multicast mode is used, a non-unicast packet received on an SPB access port is replicated once at each node using the multicast group address.
- Specifying a QoS policy list name that is inactive or does not already exist in the switch configuration is allowed. However, the list will remain inactive for the UNP until the list is enabled or configured using the QoS policy list commands (see [“Configuring QoS Policy Lists” on page 30-50](#)).
- A UNP SPB profile can be configured as a default profile for a UNP SPB access port. If authentication and classification do not return a profile name, the device is then assigned to the default SPB profile associated with the UNP SPB access port on which the device was learned. See [“Configuring UNP Port Parameters” on page 30-35](#).

To configure a UNP SPB service profile, use the **unp spb-profile** command. For example, the following command creates the “vNP1” profile to assign device traffic tagged with VLAN 10 to service 1500 bound to BVLAN 500 and apply the rules from the “ServerA_rules” policy list:

```
-> unp spb-profile vNP1 tag-value 10 isid 1500 bvlan 500 qos-policy-list
ServerA_rules
```

The following command example changes the multicast replication mode and enables egress VLAN translation for the service profile:

```
-> unp spb-profile spb3 tag-value 200 isid 1500 bvlan 4002 multicast-mode tandem
vlan-xlation enable
```

To verify the UNP SPB service profile configuration for the switch, use the **show unp spb-profile** command. For more information about profiles, see [“Configuring Profiles” on page 30-43](#).

For more information about the **unp** commands described in this section, see the “UNP Commands” chapter in the *OmniSwitch AOS Release 8 CLI Reference Guide*.

Configuring QoS Policy Lists

One of the attributes of UNP Edge, VLAN, and SPB profiles specifies the name of a QoS policy list. This list contains QoS and/or ACL policy rule definitions that are applied to a device when the device is assigned to the profile.

To create a UNP policy list, use the **policy list** command to specify a list name and then use the **policy list rules** command to specify the names of one or more existing QoS/ACL policy rules to add to the list. For example, the following commands create two policy rules and associates these rules with the “temp-rules” list:

```
-> policy condition c1 802.1p 5
-> policy action a1 disposition drop
-> policy rule r1 condition c1 action a1 no default-list
-> policy condition c2 source ip 10.5.5.0
-> policy action a2 disposition accept
-> policy rule r2 condition c2 action a2 no default-list
-> policy list temp-rules type unp
-> policy list temp-rules rules r1 r2
-> qos apply
```

Note that the **no default-list** option was used to create the rules in this example. Using this option is recommended when creating a policy list for a UNP.

Consider the following guidelines when configuring QoS/ACL policy rules and lists:

- A default policy list exists in the switch configuration. Rules are added to this list when the rule is created. A rule can belong to multiple policy lists. As a result, the rule remains a member a of the default list even when it is subsequently assigned to additional lists.
- Each time a rule is assigned to a policy list, an instance of that rule is created. Each instance is allocated system resources. To exclude a rule from the default policy list, use the **no default-list** option of the **policy rule** command when the rule is created. For example:

```
-> policy rule r1 condition c1 action a1 no default-list
```

- Up to 32 policy lists (including the default list) are supported per switch. Only one policy list per UNP is allowed, but a policy list can be associated with multiple profiles.
- If a rule is a member of multiple policy lists but one or more of these lists are disabled, the rule is still active for those lists that are enabled.
- If the QoS status of an individual rule is disabled, then the rule is disabled for all policy lists, even if a list to which the policy belongs is enabled.
- Policy lists are not active on the switch until the **qos apply** command is issued.

Use the **show policy list** command to display the QoS policy rule configuration for the switch.

For more information about configuring QoS/ACL policy lists, see [“Creating Policy Lists” on page 27-42 in Chapter 27, “Configuring QoS.”](#)

For more information about using QoS policy lists to assign and/or dynamically change role-based access for devices connected to UNP ports, see [Chapter 31, “Configuring Access Guardian.”](#)

Configuring UNP Classification Rules

UNP classification rules are defined and associated with UNP Edge, VLAN, and SPB profiles to provide an additional method for classifying a device into a profile. If authentication is not available or does not return a profile name for whatever reason, classification rules are applied to determine the profile assignment.

The following table lists the classification rules that are supported, the **unp classification** command that is used to configure each rule, and the UNP profile that supports each rule:

Precedence Step/Rule	Command	Supported Profile
1. Port	unp classification port	Edge profile
2. Group ID	unp classification group-id	Edge profile
3. MAC address	unp classification mac-address	All profiles
4. MAC OUI	unp classification mac-oui	Edge profile
5. MAC address range	unp classification mac-address-range	All profiles
6. LLDP for IP Phones	unp classification lldp med-endpoint ip-phone	Edge profile
7. Authentication Type	unp classification authentication-type	Edge profile
8. IP address	unp classification ip-address	All profiles
9. VLAN tag	unp classification vlan-tag	All profiles

For example, the following command is used to configure a MAC address range rule and assign that rule to an existing UNP Edge profile named “Engineering”:

```
-> unp classification mac-address-range 00:11:22:33:44:55 00:11:22:33:44:66
    edge-profile Engineering
```

If the source MAC address of a device falls within the specified range of the example rule, then the device is classified into the “Engineering” profile and assigned to the VLAN associated with that profile.

The VLAN tag rule can be combined with other rules to include the tag as a required parameter to match for the rule. For example, to include the VLAN tag with a MAC address rule, use the **unp classification mac-address rule** command with the **vlan-tag** option:

```
-> unp classification mac-address 00:00:2a:33:44:01 vlan-tag 10 vlan-profile
    serverA
```

In this example, a device is classified with UNP “serverA” if the source MAC address of the device is “00:00:2a:33:44:01” and device packets are tagged with VLAN 10.

When a VLAN tag rule is combined with another rule, the combined rule takes precedence over the rule that does not specify a VLAN tag. For example, a rule that specifies a MAC address and a VLAN tag takes precedence over a rule that specifies only a MAC address.

Configuring Classification Rules for UNP Port Domains

The UNP customer domain ID and the group ID are assigned to UNP ports to form a logical group of ports to which classification rules are applied. When a classification rule is configured, the **unp-customer-domain** or **group-id** parameters specify the group of ports to which the rule is applied. The type of parameter to use is based on the type of profile configured.

- The **unp-customer-domain** parameter is configurable for rules that classify traffic into a UNP VLAN or SPB profile. The classification rules are then applied only to UNP bridge and SPB access ports that are assigned to the specified customer domain ID. For example, the following commands configure classification rules that are applied only to UNP bridge or SPB access ports that are assigned to customer domain IDs 10, 5, and 2:

```
-> unp classification vlan-tag 100 unp-customer-domain 10 vlan-profile
serverA_unp
-> unp classification ip-address 10.1.1.1 mask 255.0.0.0 unp-customer-domain 5
spb-profile vm-1
-> unp classification mac-address 00:00:2a:33:44:01 unp-customer-domain 2 vlan-
profile serverB_unp
```

- The **group-id** parameter is configurable for rules that classify traffic into UNP Edge profiles. The classification rules are then applied only to UNP edge ports that are assigned to the specified group ID. For example, the following commands configure classification rules that are applied only to UNP edge ports that are assigned to group IDs 10 and 20:

```
-> unp classification group-id 10 edge-profile myProfile1
-> unp classification ip-address 10.0.0.2 group-id 1 edge-profile myProfile1
-> unp classification mac-address 00:11:22:33:44:55 group-id 1 vlan-tag 200
edge-profile myProfile1
```

See “[Configuring UNP Port Domains](#)” on page 30-42 for more information.

Configuring Binding Rules for UNP Edge Profiles

A binding rule defines a combination of one or more individual rules, all of which a device has to match. The following binding rule combinations are configurable only for UNP Edge profiles and are listed in the order of precedence:

- 1 Port + MAC address + IP address + VLAN tag
- 2 Port + MAC address + VLAN tag
- 3 Port + IP address + VLAN tag
- 4 Group ID + MAC address + IP address + VLAN tag
- 5 Group ID + MAC address + VLAN tag
- 6 Group ID + IP address + VLAN tag

The precedence order of binding rules is used to determine precedence among only binding classification rules. However, all binding rules take precedence over all individual rules. So if a device matches both an individual rule and a binding rule, the device is classified into the profile associated with the binding rule.

The same commands used to configure individual classification rules are also used to configure binding rule combinations. For example, the **unp classification mac-address** command is used in the following example to configure a binding rule that combines a MAC address rule, an IP address rule, and a port rule:

```
-> unp classification mac-address 00:11:22:33:44:55 ip-address 10.0.0.20 mask
255.255.0.0 port 1/1/1 edge-profile Profile-1
```

If the source MAC address, source IP address, *and* port of a device matches the MAC address, IP address, and port defined in the example binding rule, then the device is classified into the “Profile-1” profile and assigned to the VLAN associated with that profile.

Configuring Extended Classification Rules for UNP Edge Profiles

An Extended classification rule defines a list of individual rules and assigns the list a name and a precedence value. A device must match all of the rules specified in the extended rule list. This type of rule is configurable only for UNP Edge profiles.

The **unp classification-rule** command is used to create an extended rule and set the precedence value for the rule. The following commands are used to define classification rules and assign the rules to the extended rule name:

Precedence Step/Rule	Command
1. Port	unp classification-rule port
2. Group ID	unp classification-rule group-id
3. MAC address	unp classification-rule mac-address
4. MAC OUI	unp classification-rule mac-oui
5. MAC address range	unp classification-rule mac-address-range
6. LLDP for IP Phones	unp classification-rule lldp med-endpoint ip-phone
7. Authentication Type	unp classification-rule authentication-type
8. IP address	unp classification-rule ip-address
9. VLAN tag	unp classification vlan-tag

For example, the following commands create an extended classification rule named “ext-r1” with the precedence value set to 255 and assign the rule to a UNP Edge profile named “corporate”:

```
-> unp classification-rule ext-r1 precedence 255
-> unp classification-rule ext-r1 edge-profile corporate
```

Next, the following commands define a port rule and an authentication type rule and assign the rules to the “ext-r1” extended rule:

```
-> unp classification-rule ext-r1 port 1/1/10
-> unp classification-rule ext-r1 authentication-type 8021x
```

Note that the “ext-1” rule combines a port rule and an authentication type rule. This combination of rules is not allowed in a binding rule configuration.

The precedence value assigned to an extended classification rule is used to determine precedence among only extended classification rules. However, all extended rules take precedence over all individual and all binding rules. So if a device matches a binding rule (or an individual rule) and an extended rule, the device is classified into the profile associated with the extended rule.

Use the **show unp classification** and **show unp classification-rule** commands to verify the UNP classification rule configuration for the switch. For more information about UNP rules, see “UNP Classification Rules” on page 30-25.

UNP Application Example

The Universal Network Profile (UNP) feature provides the ability to dynamically assign network devices (physical or virtual) into a VLAN or service domain based on profile attributes. This section demonstrates this ability by providing a sample UNP configuration that applies specific profiles to various network traffic. Device traffic is assigned and forwarded on the VLAN ID associated with the UNP.

See the “Access Guardian Application Examples” section in [Chapter 31, “Configuring Access Guardian,”](#) for application examples in which Access Guardian network access control is implemented through the UNP framework.

UNP Classification

The illustration below shows the sample UNP configuration described in this section. In this configuration,

- Pre-defined UNPs on the OmniSwitch 6860 are associated with a profile name, VLAN ID, and optionally any classification rules and/or a QoS policy list.
- The RADIUS server is configured with UNP profile names associated with device MAC addresses.
- UNP functionality is enabled on the OmniSwitch 6860 ports that are connected to network devices that will generate traffic to which UNP profiles are applied.

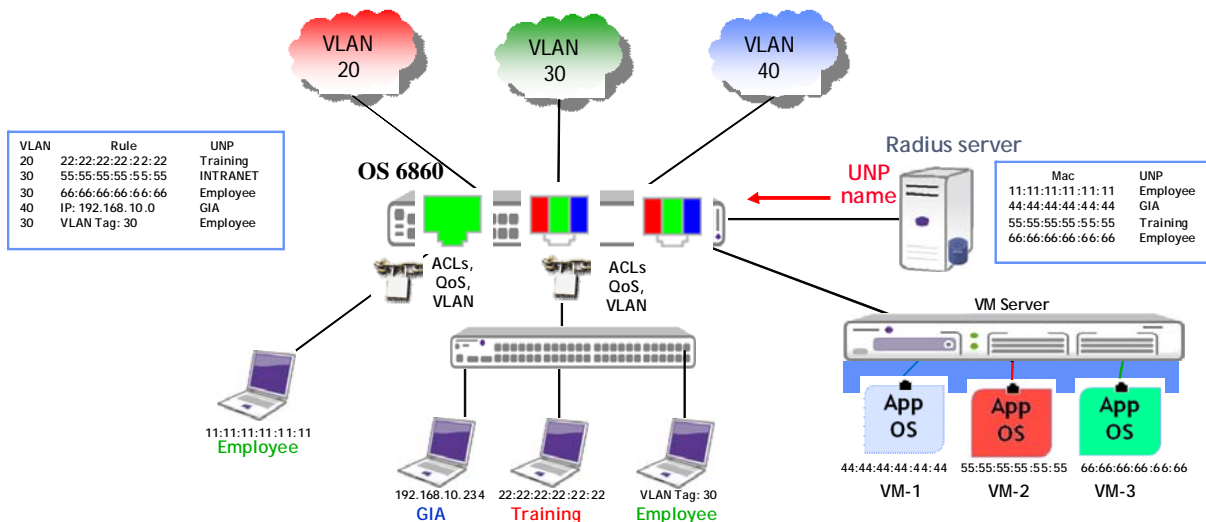

Universal Network Profile Application Example

As soon as the network devices connected to the UNP ports start sending traffic, the switch applies the UNP port and profile configuration to determine which UNP to apply to the traffic. Once the appropriate UNP is identified, the device and the port to which the device is connected are dynamically assigned to the VLAN associated with the UNP.

Because the UNP port and profile configuration is applied to each device connected to or through a UNP port, it is possible for that port to belong to more than one UNP VLAN. For example, if on the server the virtual machine “VM-1” is associated with UNP1, and “VM-2” with “UNP2” and “VM-3” with “UNP3”, then the port to which the server is connected is dynamically assigned to VLANs 10, 20, and 30.

UNP CLI Configuration Example

This section provides a tutorial for using CLI commands to configure the UNP application example.

Configure RADIUS Server Authentication

- 1 Configure a RADIUS server to use for MAC authentication using the **aaa radius-server** command.

```
-> aaa radius-server rad1
```

- 2 Enable MAC authentication for the switch and specify the RADIUS server to use for authenticating non-suplicants using the **aaa device-classification mac** command.

```
-> aaa device-classification mac rad1
```

Configure UNP VLANs and Profile Parameters

- 1 Configure VLANs 10, 20, and 30 on the OmniSwitch using the **vlan** command.

```
-> vlan 10
-> vlan 20
-> vlan 30
```

- 2 Configure UNP1 with VLAN 10 and a MAC classification rule using the **unp edge-profile** and **unp classification mac-address** commands.

```
-> unp edge-profile unp1
-> unp vlan-mapping edge-profile vlan 10
-> unp classification mac-address 11:11:11:11:11:11 edge-profile unp1
```

- 3 Configure UNP2 with VLAN 20 and a MAC classification rules using the **unp edge-profile** and **unp classification mac-address** commands.

```
-> unp edge-profile unp2
-> unp vlan-mapping edge-profile vlan 20
-> unp classification mac-address 44:44:44:44:44:44 edge-profile unp2
-> unp classification mac-address 66:66:66:66:66:66 edge-profile unp2
```

- 4 Create a QoS policy list for UNP2 and then associate the list to UNP2 using the **unp edge-profile qos-policy-list** command parameter.

```
-> policy condition c1 source ip 10.2.2.1
-> policy action a1 redirect port 1/2
-> policy rule r1 condition c1 action a1
-> policy list list1 type unp
-> policy list list1 rules r1 enable

-> unp edge-profile unp2 qos-policy-list list1
```

- 5 Configure UNP3 with VLAN 30 and a MAC classification rule using the **unp edge-profile** and **unp classification mac-address** commands.

```
-> unp edge-profile unp2
-> unp vlan-mapping edge-profile vlan 30
-> unp classification mac-address 55:55:55:55:55:55 edge-profile unp2
```

Configure UNP Port Parameters

- 1 Enable UNP on the ports to which network devices are connected. If UNP is not enabled on a port, UNP device classification is not applied to device traffic received on that port.

```
-> unp port 2/1/1
-> unp port 2/1/10
-> unp port 2/1/20
```

If port numbers are contiguous, specify a range of ports.

```
-> unp port 2/1/1-10
```

2 Enable MAC authentication on the UNP ports using the **unp mac-authentication** command. If authentication is not enabled, the MAC of the device connected to the port is not sent to the RADIUS server for authentication.

```
-> unp port 2/1/1-10 mac-authentication enable
```

3 Configure an alternate UNP, if necessary, using the **unp mac-authentication pass-alternate** command. This UNP is applied to device traffic when authentication is successful but the RADIUS server did not return a UNP name.

```
-> unp port 2/1/1-10 mac-authentication pass-alternate edge-profile macPass
```

4 Enable classification on the UNP ports using the **unp classification** command. If classification is not enabled, UNP will not apply profile rules to classify traffic.

```
-> unp port 2/1/1-10 classification enable
```

5 Configure a default UNP, if necessary, using the **unp default-edge-profile** command. This UNP is applied when all other options fail to classify the device.

```
-> unp port 2/1/1-10 default-edge-profile def_unp
```

Configure Global UNP Parameters

1 Specify a UNP to apply to device traffic when the authentication server is down using the **unp auth-server-down** command. An authentication server down timer is initiated for the device when the device is assigned to the VLAN associated with this UNP.

```
-> unp auth-server-down edge-profile temp_unp
```

2 Change the authentication server down timer value, if necessary, using the **unp auth-server-down timeout** command. When the timer value expires for a device, re-authentication and/or classification is attempted for that device.

```
-> unp auth-server-down edge-profile timeout 120
```

Verifying the UNP Configuration

A summary of the **show** commands used for verifying the UNP configuration is given here:

show unip edge-profile	Displays the Edge profile configuration for the switch.
show unip vlan-profile	Displays the VLAN profile configuration for the switch.
show unip spb-profile	Displays the Shortest Path Bridging (SPB) service profile configuration for the switch.
show unip classification	Displays the classification rules configured for each profile.
show unip global configuration	Displays the status of dynamic VLAN configuration and whether or not an authentication server down UNP is configured.
show unip group-id	Displays the group IDs configured for the switch. This type of ID is used to group UNP edge ports into logical domains.
show unip customer-domain	Displays the customer domain IDs configured for the switch. This type of ID is used to group UNP bridge and SPB access ports into logical domains.
show unip port	Displays the UNP port configuration for the switch. Lists ports that are UNP-enabled and the status of parameters for that port.
show unip user	Displays the MAC addresses learned on the UNP ports. This includes the UNP name, VLAN ID, and the status of the MAC on the port.

For more information about these commands, see the *OmniSwitch AOS Release 8 CLI Reference Guide*.

31 Configuring Access Guardian

Access Guardian refers to the following Alcatel-Lucent OmniSwitch security functions that work together to provide a dynamic, proactive network security solution:

- **Universal Network Profile (UNP)**—Access Guardian is configured and applied through the framework of the UNP feature. UNP is enabled on switch ports to activate Access Guardian functionality that is used to authenticate and classify users into UNP Edge, VLAN, or Shortest Path Bridging (SPB) profiles. Each profile is mapped to a VLAN ID or SPB Service Access Point (SAP) to which the user is dynamically assigned. Specific UNP port configurations help to simplify and easily replicate the same configuration across multiple ports.
- **Authentication, Authorization, and Accounting (AAA)**—Provides the switch-based authentication and accounting configuration that defines the RADIUS-capable servers to use for each type of Access Guardian authentication (802.1X, MAC, and Captive Portal). AAA profiles define a specific AAA configuration that can be applied at the port level (overrides the global AAA configuration).
- **Bring Your Own Device (BYOD) - OmniSwitch / ClearPass Integration:** The OmniSwitch leverages Access Guardian functionality along with the ClearPass Policy Manager (CPPM) to provide the overall BYOD solution. BYOD allows a wired guest, device, or authenticated user to connect to the network through an OmniSwitch edge device using the CPPM for unified authentication. CPPM provides the framework for device onboarding, guest registration and authentication, as well as device posture checking and profiling.
- **Captive Portal**—Internal and external Captive Portal Web-based authentication. Internal Captive Portal authentication is provided through an internal Web server on the OmniSwitch that presents default or customized Web pages to the user. A post-authentication and/or post-classification process to validate user credentials and dynamically assign a new role (policy list) to enforce user access to the network. External, guest Captive Portal authentication is provided through the OmniSwitch Access Guardian interaction with the ClearPass Policy Manager.
- **Quarantine Manager and Remediation (QMR)**—QMR is a switch-based application that restricts the network access of known quarantined users and provides a remediation path to allow quarantined users to regain their network access.

In This Chapter

This chapter provides an overview of Access Guardian security features and describes how to configure these features through the Command Line Interface (CLI). CLI commands are used in the configuration examples; for more details about the syntax of commands, see the *OmniSwitch AOS Release 8 CLI Reference Guide*.

The following information and procedures are included in this chapter:

- “Access Guardian Specifications” on page 31-3.
- “Access Guardian Defaults” on page 31-4.
- “Access Guardian Overview” on page 31-11.
- “Interaction With Other Features” on page 31-20.
- “Configuring Port-Based Network Access Control” on page 31-23.
- “Configuring UNP Profiles” on page 31-35.
- “Configuring UNP Classification Rules” on page 31-45.
- “Using Captive Portal Authentication” on page 31-48.
- “Using Quarantine Manager and Remediation” on page 31-56.
- “Access Guardian Application Examples” on page 31-58.
- “Verifying Access Guardian Users” on page 31-72.
- “Verifying the Access Guardian Configuration” on page 31-76.
- “Bring Your Own Devices (BYOD) Overview” on page 31-77.
- “Using the Multicast Domain Name System” on page 31-89.
- “Using the Simple Service Discovery Protocol” on page 31-91.
- “BYOD Application Examples” on page 31-95.

For more information about configuring the UNP feature, see [Chapter 30, “Configuring Universal Network Profiles.”](#)

Access Guardian Specifications

RFCs Supported	RFC 2284–PPP Extensible Authentication Protocol (EAP) RFC 2865–Remote Authentication Dial In User Service (RADIUS) RFC 2866–RADIUS Accounting RFC 2867–RADIUS Accounting Modifications for Tunnel Protocol Support RFC 2868–RADIUS Attributes for Tunnel Protocol Support RFC 2869–RADIUS Extensions RFC 3576--Change of Authorization-Request (COA) and Disconnect request (DM) for BYOD. RFC support is limited to ClearPass solution. RFC 3579–RADIUS Support for EAP
IEEE Standards Supported	IEEE 802.1X-2001–Standard for Port-based Network Access Control 802.1X RADIUS Usage Guidelines
Platforms Supported	OmniSwitch 6860, 6860E
Authentication methods supported	802.1X, MAC address, Captive Portal
Maximum number of Access Guardian users	1K (includes quarantined and Captive Portal users)
Maximum number of users quarantined by QMR	1K
Average number of users allowed to login to Captive portal Web pages at any given time.	40
Maximum number of Captive Portal profiles	8
Maximum number of AAA profiles	8
UNP profile types supported	Edge, VLAN, and SPB service.
Number of QoS policy lists per UNP profiles	1
Maximum number of QoS policy lists per switch	32 (excludes the default list)
Maximum number of authentication servers	4 per authentication type (MAC, 802.1X, Captive Portal)
Maximum number of accounting servers	4 per authentication type (MAC, 802.1X, Captive Portal)
BYOD Solution Server	ClearPass Policy Manager (CPPM)
mDNS GRE Tunnel Supported Protocol	IPv4
SSDP GRE Tunnel Supported Protocol	IPv4

Access Guardian Defaults

This sections contains the default configuration settings for the Access Guardian security functions that are implemented through the Universal Network Profile (UNP), Captive Portal, Quarantine Manager and Remediation (QMR) features.

Access Guardian Global Configuration Defaults

The following global default values are applied to traffic received on all UNP ports or link aggregates.

Description	Keyword	Default
Authentication server down UNP	unp auth-server-down	None
Authentication server down timer	unp auth-server-down timeout	60 seconds
Port bounce for MAC authenticated (non-suppliant) devices.	unp redirect port-bounce	Enabled
The amount of time to filter MAC addresses to trigger authentication	unp redirect pause-timer	0 (timer disabled)
HTTP proxy port number	unp redirect proxy-server-port	80, 8080, and 443
IP address to which HTTP traffic is redirected	unp redirect-server	None
Additional IP addresses to which a user can be redirected, other than the redirect server.	unp redirect allowed-name	None
Dynamic VLAN configuration for VLAN profiles.	unp dynamic-vlan-configuration	Disabled
Dynamic VLAN profile configuration.	unp dynamic-profile-configuration	Disabled
UNP Group ID	unp group-id	All edge ports belong to group 0.
UNP Customer Domain ID	unp customer-domain	All bridge and SPB access ports belong to domain 0.

Access Guardian Profile Defaults

Access Guardian profile-based functionality is implemented through the configuration of Universal Network Profiles (UNP). There are three types of UNP supported: Edge, VLAN, and SPB. This section provides the default values for all three types of profiles.

UNP Edge Profile Defaults

When a UNP Edge profile is created with the [unp edge-profile](#) command, the following default configuration is defined for the profile:

Description	Command	Default
QoS policy list.	unp edge-profile qos-policy-list	No list assigned

Description	Command	Default
Location-based policy	unp edge-profile location-policy	No policy assigned
Time-based policy.	unp edge-profile period-policy	No policy assigned
Internal Captive Portal redirect.	unp edge-profile captive-portal-authentication	Disabled
Captive Portal configuration profile.	unp edge-profile captive-portal-profile	No profile assigned
The authentication flag status for successful authentication.	unp edge-profile authentication-flag	Disabled
Create a tagged VLAN-port-association between a UNP port and the VLAN associated with the Edge profile.	unp edge-profile mobile-tag	Disabled
OmniSwitch BYOD redirect.	unp edge-profile redirect	Disabled
Maximum bandwidth value for traffic received on UNP ports assigned to the Edge profile.	unp edge-profile maximum-ingress-bandwidth	No limit set
Maximum bandwidth value for traffic sent on UNP ports assigned to the Edge profile.	unp edge-profile maximum-egress-bandwidth	No limit set
How much the traffic can burst over the maximum ingress bandwidth rate.	unp edge-profile maximum-ingress-depth	Ingress bandwidth value divided by 25 or 2K (if calculation equals 0 or 1)
How much the traffic can burst over the maximum egress bandwidth rate.	unp edge-profile maximum-egress-depth	Egress bandwidth value divided by 25 or 2K (if calculation equals 0 or 1)
VLAN-to-profile mapping.	unp vlan-mapping edge-profile	None

See “Configuring a UNP Edge Profile” on page 31-35 for more information about Edge profiles.

UNP VLAN Profile Defaults

When a UNP VLAN profile is created with the **unp vlan-profile** command, the following default configuration is defined for the profile:

Description	Command	Default
QoS policy list.	unp vlan-profile qos-policy-list	No list assigned
Create a tagged VLAN-port-association between a UNP port and the VLAN associated with VLAN the profile.	unp vlan-profile mobile-tag	Disabled
Maximum bandwidth value applied to traffic received on VLAN profile ports.	unp vlan-profile maximum-ingress-bandwidth	None

Description	Command	Default
Maximum bandwidth value applied to traffic sent on VLAN profile ports.	unp vlan-profile maximum-egress-bandwidth	None
How much the traffic can burst over the maximum ingress bandwidth rate applied to VLAN profile ports.	unp vlan-profile maximum-ingress-depth	Ingress bandwidth value divided by 25 or 2K (if calculation equals 0 or 1)
How much the traffic can burst over the maximum egress bandwidth rate applied to VLAN profile ports.	unp vlan-profile maximum-egress-depth	Egress bandwidth value divided by 25 or 2K (if calculation equals 0 or 1)

See “[Configuring a UNP VLAN Profile](#)” on page 31-38 for more information about VLAN profiles.

UNP SPB Service Profile Defaults

When a UNP Shortest Path Bridging (SPB) service profile is created with the **unp spb-profile** command, the following default configuration is defined for the profile:

Description	Command	Default
QoS policy list.	unp spb-profile qos-policy-list	No list assigned
The replication mode for the service associated with the SPB profile.	unp spb-profile multicast-mode	head-end
Egress VLAN translation for Service Access Points (SAPs) associated with the SPB profile service.	unp spb-profile vlan-xlation	Disabled
Create a tagged VLAN-port-association between a UNP port and the BVLAN associated with the SPB profile service.	unp spb-profile mobile-tag	Disabled

See “[Configuring a UNP SPB Profile](#)” on page 31-41 for more information about SPB service profiles.

See [Chapter 7, “Configuring Shortest Path Bridging,”](#) for more information about SPB services.

Access Guardian UNP Port Defaults

Access Guardian port-based functionality is implemented through the UNP feature. When UNP is enabled on a switch port or link aggregate without specifying a port type, the following default configuration for UNP edge ports is applied:

Description	Command	Default
UNP port type	unp port	Edge

Description	Command	Default
Port bounce for MAC authenticated (non-supPLICANT) devices.	unp redirect port-bounce	Enabled
802.1X authentication	unp 802.1x-authentication	Disabled
Alternate UNP Edge profile for 802.1X authenticated traffic.	unp 802.1x-authentication pass-alternate	None
Bypass 802.1x authentication for supplicants	unp 802.1x-authentication bypass	Disabled
Attempt MAC authentication or classification when 802.1X authentication fails.	unp 802.1x-authentication failure-policy	Classification
Attempt 802.1X authentication after MAC authentication when 802.1X bypass is enabled.	unp mac-authentication allow-eap	None
MAC authentication	unp mac-authentication	Disabled
Alternate UNP for MAC authenticated traffic.	unp mac-authentication pass-alternate	None
Rule-based classification	unp classification	Disabled
Default UNP Edge profile	unp default-edge-profile	None
Group ID assignment.	unp port group-id	0
AAA configuration profile assignment.	unp aaa-profile	None
Edge port template assignment.	unp port edge-template	None
Allow flooding of egress broadcast, unknown unicast, or multicast traffic.	unp direction	Both (blocked)
Trust the VLAN ID of a tagged packet to determine how the packet is classified.	unp trust-tag	Disabled
The amount of time before an EAP Request Identity is retransmitted.	unp 802.1x-authentication tx-period	30 seconds
The amount of time before the switch times out an 802.1X user attempting to authenticate.	unp 802.1x-authentication supp-timeout	30 seconds
The maximum number of requests retransmitted before the session times out.	unp 802.1x-authentication max-req	2

Access Guardian Global AAA Parameter Defaults

The following default AAA (authentication, authorization, and accounting) parameter settings are applied to Access Guardian device authentication and accounting sessions:

Description	Command	Default
The RADIUS server configuration for device authentication.	aaa device-authentication	None
The RADIUS server or switch logging configuration for accounting sessions.	aaa accounting	None
The RADIUS Calling-Station-Id attribute value	aaa accounting radius calling-station-id	User MAC address
The status of automatic 802.1X re-authentication.	aaa 802.1x re-authentication	Disabled
The amount of time between interim accounting updates per user session.	aaa interim-interval	Timer is disabled
User session time limit.	aaa session-timeout	Timer is disabled
The amount of time before an inactive user is logged out of a session.	aaa inactivity-logout	Timer is disabled
The RADIUS NAS-Port attribute value	aaa radius nas-port-id	User port (chassis/slot/port)
The RADIUS NAS-Identifier attribute value	aaa radius nas-identifier	System name
The MAC address format to use when RADIUS client attributes specify a MAC address value.	aaa radius mac-format	No delimiter Uppercase characters

Access Guardian AAA Profile Defaults

An AAA profile defines and applies specific settings to UNP Edge ports, link aggregates, or an Access Guardian Captive Portal profile. The following table lists the default profile settings that are defined when an AAA profile is created through the **aaa profile** command:

Description	Keyword	Default
The RADIUS server configuration for device authentication.	device-authentication	None
The RADIUS server or switch logging configuration for accounting sessions.	accounting	None
The RADIUS Calling-Station-Id attribute value	accounting radius calling-station-id	User MAC address

Description	Keyword	Default
The status of automatic 802.1X re-authentication.	802.1x re-authentication	Disabled
The amount of time between interim accounting updates per user session.	interim-interval	Timer is disabled
User session time limit.	session-timeout	Timer is disabled
The amount of time before an inactive user is logged out of a session.	inactivity-logout	Timer is disabled
The RADIUS NAS-Port attribute value	radius nas-port-id	User port (chassis/slot/port)
The RADIUS NAS-Identifier attribute value	radius nas-identifier	System name
The MAC address format to use when RADIUS client attributes specify a MAC address value.	radius mac-format	No delimiter Uppercase characters

Access Guardian Captive Portal Defaults

The following global default configuration settings apply to the OmniSwitch internal implementation of the Captive Portal feature:

Description	Command	Default
Redirect URL name	captive-portal name	“captive-portal.com”
Redirect IP address	captive-portal ip-address	10.123.0.1
Redirect user after successful Captive Portal login.	captive-portal success-redirect-url	No redirect
Proxy server port number	captive-portal proxy-server-port	8080
Number of login attempts allowed per Captive Portal session.	captive-portal retry-count	3
QoS policy list or UNP Edge profile to apply to a user device after a successful Captive Portal login.	captive-portal authentication-pass	None
Use custom Web pages for Captive Portal sessions.	captive-portal customization	Disabled
The amount of time between interim accounting updates for Captive Portal sessions.	aaa interim-interval	Timer is disabled
Captive Portal session time limit.	aaa session-timeout	Timer is disabled

Description	Command	Default
The amount of time before an inactive user is logged out of a Captive Portal session.	aaa inactivity-logout	Timer is disabled

Access Guardian Captive Portal Profile Defaults

A Captive Portal profile defines and applies specific settings to devices classified into an Edge profile to which the Captive Portal profile is assigned. The following table lists the default profile settings that are defined when a Captive Portal profile is created through the [captive-portal-profile](#) command:

Description	Keyword	Default
AAA configuration profile assigned to the Captive Portal profile.	aaa-profile	No profile assigned (Global AAA settings apply)
Redirect user after successful login.	success-redirect-url	No redirect
Number of login attempts allowed.	retry-count	3
QoS policy list to apply after successful Captive Portal login.	authentication-pass policy-list	No list assigned
UNP Edge profile to apply after successful Captive Portal login.	authentication-pass edge-profile	No profile assigned
Change profile assignment after successful Captive Portal login.	authentication-pass edge-profile-change	Disabled

Access Guardian QMR Defaults

The following global default configuration settings apply for the OmniSwitch implementation of the Quarantine Manage and Remediation (QMR) feature:

Description	Command	Default
The URL for a remediation server	qmr quarantine path	None
Whether a “Quarantined” page is sent to the user when a remediation server URL is not configured	qmr quarantine page	No page is sent
The IP network addresses that a restricted quarantined user is allowed to access	qmr quarantine allowed-name	None
Proxy server port number	qmr quarantine custom-proxy	8080
The name of the Quarantine MAC address group on the switch.	qos quarantine mac-group	No name is configured

Access Guardian Overview

Access Guardian is a combination of authentication, device compliance, and access control functions that provide a *proactive* solution for network security. Implemented through the switch hardware and software, Access Guardian helps administrators:

- Determine who is on the network.
- Check if end users are compliant.
- Direct what end users can access within the network.

The Access Guardian features work together to provide a dynamic, integrated security framework. As shown in the following diagram:

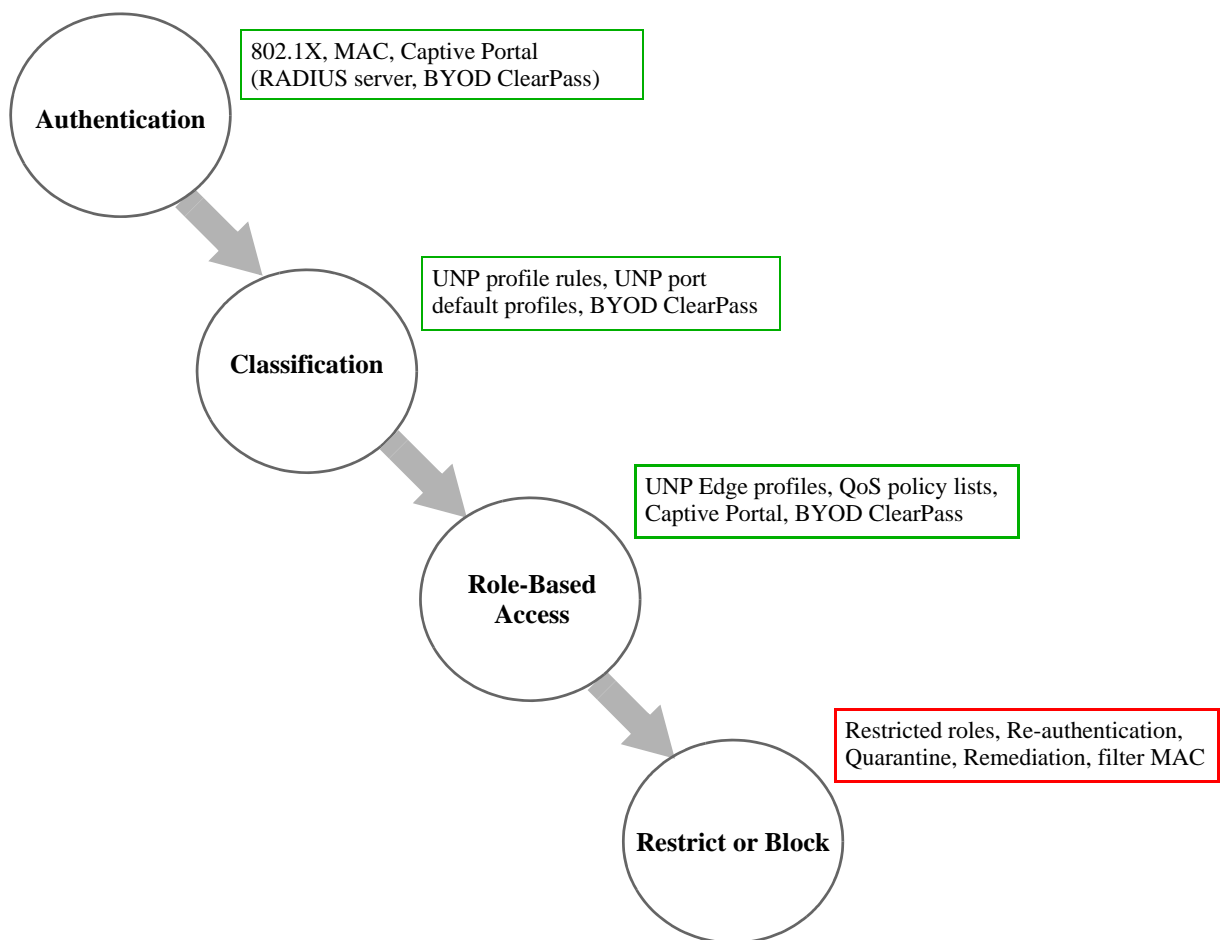

The Access Guardian feature is implemented through the following switch-based functionality:

- MAC-based and 802.1X-based authentication using a RADIUS-capable server.
- Universal Network Profile (UNP) framework to provide network access control and Quality of Service (QoS) on a per-user basis.
- Switch-wide classification rules to classify users based on port and device attributes (for example, source MAC, Group ID, IP address). No authentication required.

- Default UNP classification for traffic not classified through other methods.
- Internal Captive Portal for Web-based authentication. Provides dynamic role change for the user device.
- Integration with ClearPass Policy Manager (CPPM) as part of the OmniSwitch Bring Your Own Device (BYOD) network access solution.

This chapter documents the functionality of the Access Guardian feature and how it is configured on the OmniSwitch.

Device Authentication

Physical devices attached to a LAN port on the switch through a point-to-point LAN connection can be authenticated through the switch using port-based network access control. This control is available through the Universal Network Profile (UNP) feature implemented on the switch.

Access Guardian uses the UNP feature to provide configurable authentication and classification mechanisms for both 802.1x clients (supplicants) and non-802.1x clients (non-supplicants). The following options for authentication are available:

- **802.1X authentication for supplicants.**

Uses Extensible Authentication Protocol (EAP) between an end device and a network device (NAS) to authenticate the supplicant through a RADIUS server. If authentication returns a UNP, the supplicant is assigned to that UNP. If a UNP name is not returned or authentication fails, then the UNP port and classification rule configuration provides the network access control for the supplicant.

- **MAC-based authentication for non-supplicants.**

MAC-based authentication does not require any agent or special protocol on the non-suppliant device; the source MAC address of the device is verified through a remote RADIUS server. The switch sends RADIUS frames to the server with the source MAC address embedded in the username and password attributes. If authentication returns a UNP name, the non-suppliant is assigned to that profile. If a UNP name is not returned or authentication fails, then the UNP port and classification rule configuration provides the network access control for the non-suppliant.

For non-suppliant authentication, the client MAC address is sent as username and password. The administrator can configure the password and username on the authentication server as the MAC address of the client. The calling-station-ID, accounting-session-ID are also sent for authentication. All these IDs can be in uppercase or lowercase.

- **Internal Captive Portal authentication.**

Internal Captive Portal authentication is a configurable option for a UNP Edge profile that is applied after a user is initially assigned to that profile (after the initial 802.1X or MAC authentication or classification process). Captive Portal provides a secondary level of authentication that is used to apply a new role (QoS policy list) to the user. This type of authentication may change the Edge profile assignment for the user device.

When a user is classified into a profile that has the Captive Portal option enabled, a Web page is presented to the user device to prompt the user to enter login credentials. The credentials are then authenticated through a RADIUS server. If the authentication process results in a new policy list or new Edge profile, the policy list or profile is applied to the user device. If a policy list or profile is not assigned or authentication fails, the policy list associated with the initial Edge profile is used to define the network access role for the user.

- **External Captive Portal authentication.**

External Captive Portal authentication is provided through the OmniSwitch Bring Your Own Device (BYOD) solution. Access Guardian, through the UNP port and profile framework, redirects user device traffic to the ClearPass Policy Manager (CPPM) server for Guest Access using the CPPM Guest module.

802.1X and MAC authentication are Layer 2 mechanisms that are configured and invoked at the port level. A UNP port is enabled with either 802.1X, MAC, or both types of authentication. Devices connected to UNP ports undergo the type of authentication configured on the port.

Internal and external Captive Portal authentication are Layer 3 mechanisms that are invoked through the UNP Edge profile configuration. Devices connected to UNP ports initially undergo Layer 2 authentication and/or classification at the port level to determine an initial UNP Edge profile assignment. Then, based on the profile settings, the user may be redirected for Layer 3 authentication.

The authentication functionality provided allows the administrator to assign the appropriate method of authentication. Multiple authentication methods for multiple users (many users or different types of users, such as IP phones) are supported on the same port.

Device Classification

Successful device authentication can result in a UNP profile assignment for the user device. However, if authentication is not available or does not return a profile name for whatever reason, the following additional UNP device classification methods are available to classify a user device into a profile:

- **UNP classification rules.** Switch-wide classification rules to classify users based on port and device attributes (for example, source MAC, Group ID, IP address). Classification rules are associated with profiles and are applied to traffic received on UNP-enabled ports. When any of the traffic matches one of the classification rules, the user device is dynamically assigned to the matching profile.
- **Alternate pass UNP.** A UNP associated with a UNP port to which traffic is assigned when successful 802.1X or MAC authentication does not return a UNP name.
- **Default UNP.** A UNP associated with a UNP port to which traffic is assigned when other authentication or classification attempts fail to provide a profile name.
- **Trust VLAN tag.** Configured on a UNP port to specify whether or not to trust the VLAN tag of the packets received on the port. If this option is enabled and the VLAN tag matches an existing VLAN in the switch configuration, the traffic is assigned to that VLAN when other authentication or classification attempts fail to provide a profile name.
- **Authentication server down UNP.** A global UNP that provides a temporary profile for devices unable to authenticate because the RADIUS server is unreachable. This profile is associated with a timer that determines how long the device remains in the temporary profile before authentication is attempted again.

Enabling 802.1X and/or MAC authentication on UNP ports is optional; an administrator may decide to use UNP classification rules instead. When enabled, however, the authentication method takes precedence over classification methods.

Role-based Access

When a user is authenticated and/or classified into a UNP profile, the initial role of that user is determined by whether or not there is a QoS policy list associated with the profile.

- If there is no policy list available, then the user has full access to the switch and network resources as provided through the profile VLAN or service domain to which the user was assigned.
- If a policy list is available, then the QoS policy rules associated with that list are applied to the port and traffic of the user device.

Access Guardian provides the following post-authentication and post-classification mechanisms for dynamically changing the role (QoS policy list) applied to a user device.

- **Internal Captive Portal.** User undergoes a secondary authentication process through Captive Portal Web-based authentication. Successful Captive Portal authentication applies the QoS policy list returned from the RADIUS server or specified in the Captive Portal authentication pass configuration. The newly obtained policy list overrides the policy list associated with the Edge profile to which the device was initially assigned. The outcome of this process may change the Edge profile assignment for the user device. See [“Using Captive Portal Authentication” on page 31-48](#) for more information.
- **Location and Time Policies.** When a user classified into the Edge profile violates a location or time policy associated with the profile, a built-in unauthorized restricted role is applied to that user, overriding the policy list associated with the profile.
- **Built-in Restricted Roles.** When one of the built-in restricted roles is applied to a user device, an implicit QoS policy list associated with that role is applied to that device instead of the Edge profile policy list. A custom policy list can be associated with a restricted role to override the built-in role.
- **User-defined Roles.** When the state of a device matches specific conditions configured for a user-defined role. An explicit QoS policy list associated with this type of role is applied to the device instead of the Edge profile policy list.

Built-in Restricted Roles

The following types of built-in roles are applied to the user device based on the state of the Access Guardian user:

- **Internal Captive Portal pre-login role**—applied when a user is classified into a UNP Edge profile that has the Captive Portal flag enabled. While in this pre-login state, only DHCP, DNS, ARP, and ICMP traffic from the user device is allowed. In addition, HTTP/HTTPS traffic is trapped and redirected to the internal Captive Portal server.
- **Unauthorized role**—applied when a user classified into a UNP Edge profile violates the location or time policies configured for that profile. Traffic from “unauthorized” users is blocked.
- **QMR role**—applied to quarantined MAC addresses. Traffic from quarantined devices is blocked and HTTP traffic is trapped. When the user opens a browser, HTTP/HTTPS traffic is redirected to a remediation server, if one is configured for QMR on the switch.

Explicit QoS Policy Lists for Built-in Roles

When an Access Guardian user is placed into one of the built-in restricted roles (unauthorized, Captive Portal pre-login, or QMR) the QoS policy list associated with that role is applied to the user. However, it is possible to define and apply an explicit (custom) policy list to a built-in restricted role. When this is done, the explicit policy list will determine how traffic from the user is controlled.

User-Defined Roles

A user-defined role applies an explicit QoS policy list to an Access Guardian user based on the following conditions:

- The user was classified into a specific UNP Edge profile.
- The type of authentication applied to the user device (802.1X, MAC, or none). Can also define this condition based on whether or not the user failed 802.1X or MAC authentication.
- The user is in a Captive Portal post-login state.

The explicit policy list is not applied to a user unless all of the conditions configured for the user-defined role are met.

In addition to these conditions, a precedence value is configured for user-defined roles. This value is used to determine precedence among other user-defined roles. Every time the user context changes for a device, all the user-defined roles are checked to see if there is a role that matches the current user context.

UNP Profiles

Access Guardian role-based network access is achieved through the OmniSwitch Universal Network Profile (UNP) feature. A UNP profile defines network access for one or more user devices. Each device that is assigned to a specific profile is granted network access based on the profile criteria, instead of on an individual MAC address, IP address, or port basis.

Assigning users to a profile provides greater flexibility and scalability across the network. Administrators can use profiles to group users according to function. All users assigned to the same UNP become members of that profile group. The UNP then determines what network access resources are available to a group of users, regardless of source subnet, VLAN, or other characteristics.

Dynamic assignment of devices to UNP profiles is achieved through UNP port-based functionality that provides the ability to authenticate and classify device traffic. Authentication verifies the device identity and provides a UNP name. In the event authentication is not available or is unsuccessful, classification rules associated with profiles or UNP port configuration parameters are applied to the traffic to determine the UNP assignment.

UNP supports three types of classification profiles:

- **VLAN profile.** This type of profile creates a VLAN-port association (VPA) for device traffic that is classified into the profile. The VPA represents an association between the UNP port on which the device traffic was received and the VLAN ID specified by the profile. Once classified into a specific profile, device traffic is tagged to forward on the UNP VLAN.
- **Edge profile.** This type of profile also creates a VPA between the UNP port on which device traffic was received and the VLAN ID associated with the profile. Device traffic is then forwarded on the VLAN ID associated with the profile. Specifically designed to offer network access control to edge devices, Edge profiles offer additional attributes to redirect devices for internal Captive Portal authentication and integration with the OmniSwitch Bring Your Own Device (BYOD) solution.
- **SPB profile.** The OmniSwitch supports Shortest Path Bridging (SPB) service profiles. This type of profile creates an association between device traffic that is classified into the profile and a Service Access Point (SAP). Once classified into a specific profile, device traffic is then forwarded on the SPB service associated with the SAP.

The OmniSwitch supports two separate traffic domains: VLAN and service. The availability of two VLAN-based profiles (Edge and VLAN) and an SPB service profile provides an efficient method for network access control and dynamic assignment of device traffic to one of these domains.

Using the VLAN and Edge profiles, an administrator can implement the same UNP name across the entire network infrastructure, as the VLAN association is kept locally on each switch. For example, the administrator can deploy the UNP named “Engineering” in one building using VLAN 10, while the same

UNP deployed in another building can use VLAN 20. The same UNP access controls are applied to all profile devices in each building, even though they belong to different VLANs.

The SPB service profile is particularly useful in the Alcatel-Lucent Data Center solution to facilitate virtual machine (VM) discovery and movement. UNP service profiles used for such purposes are also referred to as virtual network profiles (vNPs).

The following table provides a list of configurable profile attributes and the profile type that supports each attribute. For example:

- Classification rules are configurable for a UNP Edge, VLAN, and SPB profile, so the “Supported Profile” field contains “All profiles” for this attribute.
- The VLAN mapping is only configurable for a UNP Edge and VLAN profile, so the “Supported Profile” field contains “Edge and VLAN profiles” for this attribute.

Profile Attribute	Supported Profile
Classification Rules. A UNP can specify classification rules that are used to assign devices to a profile based on the source MAC address, source IP address, or VLAN tag of device packets. UNP rules are applied based on the outcome of authentication.	All profiles
QoS policy list name. Specifies the name of an existing list of QoS policy rules. The rules within the list are applied to all members of the profile group to enforce access to network resources. Only one policy list is allowed per profile, but multiple profiles may use the same policy list.	All profiles
Mobile tag. The mobile tag status for the profile. When enabled, the UNP port to which a device is connected is tagged with the VLAN mapped to the profile when the device is classified into that profile.	All profiles
VLAN ID (VLAN mapping). All members of the profile group are assigned to the VLAN ID specified by the profile (also referred to as the UNP VLAN).	Edge and VLAN profiles
Maximum ingress and egress bandwidth. The maximum bandwidth limit allocated for ingress and egress traffic on UNP ports assigned to the profile.	Edge and VLAN profiles
Maximum ingress and egress depth. Specifies how much ingress and egress traffic can burst over the maximum ingress and egress bandwidth rate.	Edge and VLAN profiles
Tag value. A VLAN tag value that UNP uses to determine the Service Access Point (SAP) to which classified traffic is mapped. If this value is set to zero, untagged traffic is classified to this profile creating an untagged SAP.	SPB profile
Service Instance Identifier (I-SID). A service instance identifier that is used to identify an SPB service in a provider backbone bridge (PBB) network. The specified I-SID is bound to the SPB BVLAN for the profile.	SPB profile
Backbone VLAN (BVLAN). The SPB BVLAN on which classified profile traffic is forwarded. The BVLAN ID specified must already exist in the switch configuration.	SPB profile
Location-based policy. Defines criteria (such as the slot/port, system name and location) to determine if a device is accessing the network from a valid location. If a device violates this policy, the device is placed into an unauthorized state, even though it is still assigned to the profile.	Edge profile

Profile Attribute	Supported Profile
Time-based policy. Specifies the days and times during which a device can access the network. If a device violates this policy, the device is placed into an unauthorized state, even though it is still assigned to the profile.	Edge profile
Captive Portal authentication. Configures the Captive Portal status for the profile. When enabled, the internal Captive Portal authentication process is triggered when a user device is assigned to the profile.	Edge profile
Captive Portal profile. Specifies the name of a Captive Portal configuration profile to apply to user devices when Captive Portal authentication is enabled for the UNP. The configuration defined in the Captive Portal profile overrides the global Captive Portal configuration for the switch.	Edge profile
Redirect flag. Configures the redirect status for the profile. When enabled, the profile will interact with the ClearPass Policy Manager (CPPM) as part of the OmniSwitch Bring Your Own Devices (BYOD) solution	Edge profile

For more information about configuring a UNP, see [“Configuring UNP Profiles” on page 31-35](#) and [Chapter 30, “Configuring Universal Network Profiles.”](#)

UNP Classification Rules

Classifying devices with UNP rules allows the administrator to assign users to a profile group based on port and device attributes, such as the source IP address, source MAC address, port, or group ID of the device. For example:

- Classification is enabled on UNP port 1/1/10.
- A MAC address range classification rule is associated with a UNP Edge profile named “Engineering”. This rule defines a MAC address range of “00:11:22:33:44:55 through 00:11:22:33:44:66”.
- A device connecting to port 1/1/10 with a source MAC address that falls within the specified MAC address range is assigned to the “Engineering” profile. The device and port on which the device was learned are also dynamically assigned to the VLAN associated with the profile.

Enabling classification and defining classification rules is optional with UNP. When enabled, however, classification rules are only applied to UNP ports when one of the following occurs:

- 802.1X and MAC authentication are disabled on the port.
- 802.1X and/or MAC authentication is enabled but the RADIUS server is not configured.
- 802.1X and/or MAC authentication is enabled but RADIUS authentication did not return a UNP name or failed.

If classification is disabled on a UNP port, classification rules are not applied to traffic received on that port. If both authentication and classification are disabled on a UNP port, traffic received on that port is blocked, unless a default UNP is configured for that port.

UNP Rule Types

A classification rule specifies the criteria that a device must match and the name of a UNP Edge, VLAN, or SPB profile that is applied to the device when the match occurs. The following table lists all the UNP classification rules and the type of UNP profile that supports each rule. For example:

- The MAC address rule is configurable for a UNP Edge, VLAN, and SPB profile, so the “Supported Profile” field contains “All profiles” for the MAC address rule type.
- The Port rule is only configurable for a UNP Edge profile, so the “Supported Profile” field contains “Edge profile” for the Port rule type.

The rules are listed in the order of precedence (highest to lowest).

Precedence Step/Rule	Matching Condition	Supported Profile
1. Port + VLAN tag	Packet is learned on a matching port or link aggregate <i>and</i> the packet contains a matching VLAN ID tag.	Edge profile
2. Port	Packet is learned on a matching port or link aggregate.	Edge profile
3. Group ID + VLAN tag	Packet is learned on a port or link aggregate that is assigned to a matching group ID <i>and</i> the packet contains a matching VLAN ID tag.	Edge profile
4. Group ID	Packet is learned on a port or link aggregate that is assigned to a matching group ID.	Edge profile
5. MAC address + VLAN tag	Packet contains a matching source MAC address <i>and</i> a matching VLAN ID tag.	All profiles
6. MAC address	Packet contains a matching source MAC address.	All profiles
7. MAC OUI + VLAN tag	Packet contains a source MAC address with a matching OUI and a matching VLAN ID tag.	Edge profile
8. MAC OUI	Packet contains a source MAC address with a matching OUI.	Edge profile
9. MAC address range + VLAN tag	Packet contains a source MAC address that falls within a specified range of MAC addresses <i>and</i> a matching VLAN ID tag.	All profiles
10. MAC address range	Packet contains a source MAC address that falls within a specified range of MAC addresses.	All profiles
11. LLDP for IP Phones	LLDP TLVs from an IP phone are detected.	Edge profile
12. Authentication Type + VLAN tag	Packet received from a device authenticated through the matching authentication type <i>and</i> the packet contains a matching VLAN ID tag.	Edge profile
13. Authentication Type	Packet received from a device authenticated through the matching authentication type.	Edge profile
14. IP address + VLAN tag	Packet contains a matching source IP address <i>and</i> a matching VLAN ID tag.	All profiles
15. IP address	Packet contains a matching source IP address.	All profile
16. VLAN tag	Packet contains a matching VLAN ID tag.	All profiles

Binding Classification Rules for UNP Edge Profiles

Individual classification rules can be combined with other classification rules to create a binding rule. The following binding rule combinations are supported only with UNP Edge profiles and are listed in the order of precedence:

- 1 Port + MAC address + IP address + VLAN tag
- 2 Port + MAC address + VLAN tag
- 3 Port + IP address + VLAN tag
- 4 Group ID + MAC address + IP address + VLAN tag
- 5 Group ID + MAC address + VLAN tag
- 6 Group ID + IP address + VLAN tag

A device must match all the rules specified in the binding rule combination. For example, if a binding rule specifies a Port, MAC address, and IP address, then the device must have a matching port, source MAC address, *and* source IP address.

Note. Binding classification rules are only associated with UNP Edge profiles and take precedence over individual classification rules.

Extended Classification Rules for UNP Edge Profiles

An Extended classification rule defines a list of individual rules and assigns the list a name and a precedence value. A device must match all of the rules specified in the extended rule list.

The precedence value assigned to the extended rule's name is used to determine precedence among other extended classification rules configured on the switch. If a device matches all the criteria in two different extended rules, the rule with the highest precedence is applied to the device.

Although some individual classification rules can be combined to form a binding rule, a binding rule is not assigned a rule name and does not have a configurable precedence value. In addition, extended classification rules offer more rule combinations than binding rules.

Note. Extended classification rules are only associated with UNP Edge profiles and take precedence over all other UNP classification rule types (individual rules and binding rules).

For more information see [“Configuring UNP Classification Rules”](#) on page 31-45 and [Chapter 30, “Configuring Universal Network Profiles.”](#)

Interaction With Other Features

This section contains important information about how other OmniSwitch features interact with Access Guardian. Refer to the specific chapter for each feature to get more detailed information about how to configure and use the feature.

OmniSwitch Bring Your Own Devices (BYOD)

Access Guardian interacts with the ClearPass Policy Manager (CPPM) platform to provide support for the OmniSwitch BYOD unified access solution.

- Configurable switch parameters to redirect traffic to the CPPM server.
- A configurable redirect parameter for UNP Edge profiles to allow devices assigned to the profile to honor CoA and DM messages from the CPPM.
- A port bounce operation is configurable on UNP ports to trigger re-authentication of non-suplicants upon receipt of CoA and DM messages.
- A global pause timer is available to determine the amount of time the switch filters traffic from non-suplicant (non-802.1X) devices on all UNP ports. This is done to clear the context of the user and is triggered upon receipt of a CoA message that requires a VLAN change for the device.

For more information about the OmniSwitch BYOD solution, see [“Bring Your Own Devices \(BYOD\) Overview” on page 31-77](#).

Authentication, Authorization, and Accounting (AAA)

The AAA configuration for the switch determines the following for Access Guardian functionality:

- Which RADIUS servers or ClearPass Policy Manager (CPPM) servers to use for Access Guardian authentication and accounting sessions.
- Authentication parameter values, such as the session timeout, inactivity timeout, interim accounting update interval, and 802.1X re-authentication interval for authentication and accounting sessions.
- AAA profiles to define a custom, pre-defined AAA configuration that can be applied to a specific set of UNP ports or through a Captive Portal profile.

Learned Port Security

UNP and Learned Port Security (LPS) are supported on the same port with the following conditions:

- LPS is not supported on link aggregates.
- The LPS learning window is set globally but not on a per-port basis. So the window applies to all UNP ports.
- When LPS is enabled or disabled on a UNP edge or bridge port (LPS is not supported on UNP access ports), MAC addresses already learned on that port are flushed.
- Configuring a static MAC address is not allowed on a UNP port unless LPS is also enabled on the same port.
- When both LPS and UNP are enabled on the same port,

- UNP first authenticates and classifies any MAC addresses received, then LPS rules are applied.
- If a MAC address violates any of the LPS rules for the port, the address may get filtered or the port violated even if UNP initially determined the address was valid. In other words, LPS rules take precedence over UNP to determine if a MAC address is bridged or filtered on the port.
- If UNP classifies a MAC address as learning but LPS learns the address as filtering, an untagged packet will show as filtering in the default VLAN for the port and a tagged packet MAC will show as filtering in the specific tagged VLAN.
- When a MAC address is filtered by LPS, the `show unip edge-user` command will display “LPS-Blocked” as the classification source for that MAC address.

Quality of Service (QoS)

The Access Guardian feature provides the ability to assign a list of QoS policy rules to a UNP. The rules contained in the list are applied to any device that is assigned to the UNP. Consider the following guidelines when configuring policy lists for user profiles:

- QoS policy rules and policy lists are configured using the OmniSwitch QoS feature. Configuration of these items is required before the list is assigned to a UNP.
- Configuring QoS policy lists is not allowed if VLAN Stacking Services or if QoS inner VLAN or inner 802.1Q tag policies are configured for the switch.
- Only one QoS policy list per UNP is allowed, but multiple profiles can use the same UNP. Up to 32 policy lists (including the default list) are allowed per switch.
- A default QoS policy list always exists in the switch configuration. Any QoS policies that are not assigned to a user profile belong to the default list, unless specified otherwise when the policy is created.
- If a QoS policy list is configured for a user profile, only the policy rules in the list are applied to traffic from devices classified into the profile. Any default list policy rules are not applied in this case.
- If a QoS policy list is not specified for a user profile, then any policies from the default list are applied to profile devices.
- If a policy rule is enabled, it is active for all policy lists to which it belongs. If one of the policy lists is disabled, the rule is still active for all the other lists.
- If a policy rule is disabled, it is no longer active in any policy list to which it belongs, even if the list is still enabled.

Universal Network Profile (UNP)

Access Guardian functionality is implemented through the framework of the UNP feature.

- Access Guardian functionality is supported only on UNP-enabled ports or link aggregates.
- The UNP port configuration determines the following for devices connected to a UNP port or link aggregate:
 - The type of authentication (802.1X and/or MAC) attempted, if any.
 - Whether device classification is enabled to move devices into profiles based on the outcome of the authentication process, if any.

- If devices that do not receive a UNP assignment through the authentication or classification process are assigned to a default profile associated with the port.
- There are three type of UNP ports supported: Edge, Bridge, and SPB access. The traffic received on each port type is classified into the corresponding profile type (Edge, VLAN, and SPB) for each port. Classification rules configured for each profile type are applied only to traffic learned on UNP ports to which the profile is applied. For example:
 - Edge profiles classify traffic received on UNP edge ports.
 - VLAN profiles classify traffic received on UNP bridge ports.
 - SPB service profiles classify traffic received on UNP access ports.

Configuring Port-Based Network Access Control

For port-based network access control, the switch must know which servers to use for authenticating supplicant (802.1X) and non-suppliant (non-802.1X) user devices.

In addition, UNP must be enabled on each port that is connected to a supplicant or non-suppliant device. Optional parameters can be set for each UNP port. Edge profiles define attributes used to enforce network access control on devices classified into the profile.

The following sections describe these procedures in detail:

- [“Setting Authentication Parameters for the Switch” on page 31-24.](#)
- [“Configuring UNP Port-Based Functionality” on page 31-27.](#)
- [“Configuring UNP Profiles” on page 31-35.](#)
- [“Configuring QoS Policy Lists” on page 31-43.](#)
- [“Configuring UNP Classification Rules” on page 31-45.](#)

Setting Authentication Parameters for the Switch

Use the **aaa device-authentication** command to specify which servers the switch will use for 802.1X, MAC, and Captive Portal authentication. The servers must already be configured through the **aaa radius-server** command. An example of setting the switch to use specific servers for 802.1X authentication:

```
-> aaa device-authentication 802.1x rad1 rad2
```

In this example, the **rad1** server is used for authenticating user devices connected to UNP ports on which 802.1X authentication is enabled. If **rad1** becomes unavailable, the switch then uses **rad2** for 802.1X authentication.

To set the switch to use specific servers for MAC authentication, use the **aaa device-authentication** command with the **mac** parameter. For example:

```
-> aaa device-authentication mac rad1 rad2
```

In this example, the **rad1** server is used for authenticating user devices connected to UNP ports on which MAC authentication is enabled. As in the 802.1X authentication example, if **rad1** becomes unavailable, the switch will then use **rad2** for MAC authentication.

To set the switch to use specific servers for internal Captive Portal authentication, use the **aaa device-authentication** command with the **captive-portal** parameter. For example:

```
-> aaa device-authentication captive-portal rad1 rad2
```

In this example, the **rad1** server is used for authenticating user devices connected to UNP ports that are classified into an Edge profile that has Captive Portal authentication enabled. As in the 802.1X and MAC authentication example, if **rad1** becomes unavailable, the switch will then use **rad2** for internal Captive Portal authentication.

Note. The same RADIUS servers can be used for 802.1x, MAC, and Captive Portal authentication. Using different servers for each type of authentication is allowed but not required. For more information about configuring authentication servers, see [Chapter 35, “AAA Commands.”](#)

For more information about authentication of supplicant and non-supplicant devices, see [“Device Authentication” on page 31-12.](#)

Accounting Servers

Use the **aaa accounting** command to create an accounting server entry for 802.1X, MAC, and Captive Portal authentication. For example, the following commands specify accounting servers for each type of authentication:

```
-> aaa accounting mac rad1 rad2 rad3
-> aaa accounting 802.1x rad1 rad2 rad3 rad4
-> aaa accounting captive-portal rad1 rad2 rad3
```

Optionally, the Switch Logging (syslog) facility can be used for the accounting function. For example, the following commands specify syslog as the accounting server for each type of authentication:

```
-> aaa accounting 802.1x syslog 10.135.67.99 port 8000
-> aaa accounting mac syslog 10.135.67.99 port 8000
-> aaa accounting captive-portal syslog 10.135.67.99 port 8000
```

Accounting with the local syslog facility is not allowed if RADIUS accounting is already configured. In other words, configure either RADIUS *or* syslog accounting.

Configuring Authentication Session Parameters

The following table provides a list of configurable authentication session parameters, the default value for each parameter, and the authentication type (802.1X, MAC, or Captive Portal) to which the parameter applies:

Description	Command	Default	Authentication Type
The amount of time a session remains active after a successful login	aaa session-timeout	Timer = disabled Time limit = 43200 seconds (12 hours)	MAC, Captive Portal
The amount of time an inactive user can remain logged on	aaa inactivity-logout	Timer = disabled Time limit = MAC address aging time	MAC, Captive Portal
Accounting update interval	aaa interim-interval	600 seconds	802.1X, MAC, Captive Portal
Number of login attempts allowed per session	captive-portal retry-count	3	Captive Portal
The re-authentication time interval	aaa 802.1x re-authentication	Timer = disabled Time limit = 3600 seconds	802.1X
The port identifier for the NAS-Port attribute	aaa radius nas-port-id	User port	802.1X, MAC, Captive Portal
The system identifier for the NAS-Identifier attribute	aaa radius nas-identifier	System name	802.1X, MAC, Captive Portal
The MAC address format for the Calling-Station-Id and the Called-Station-ID attributes	aaa radius mac-format	No delimiter, uppercase	802.1X, MAC, Captive Portal

The **aaa session-timeout**, **aaa interim-interval**, and **aaa 802.1x re-authentication** include a **trust-radius** option that is disabled by default. When enabled, the value for the time is taken from the following RADIUS attribute values returned from the RADIUS server. For example:

- The Session-Timeout attribute value received in an Access-Accept messages is used for the session timeout and 802.1X re-authentication parameter values.
- The Acct-Interim-Interval attribute value received in an Access-Accept message is used for the accounting interim update interval parameter.

Use the **show aaa config** command to display the current authentication session parameters values for each type of authentication.

Use the **show aaa radius config** command to display RADIUS client attribute values and the MAC address format.

For more information about the commands described in this section, see the *OmniSwitch AOS Release 8 CLI Reference Guide*.

Using AAA Configuration Profiles

An AAA profile is a configuration entity that provides flexible assignment of switch-based authentication parameters to specific UNP ports. When an AAA profile is assigned to a UNP port, the parameter values defined in the profile are applied to the sessions on that port. The profile configuration overrides the global AAA configuration for users authenticating on the assigned port.

Use an AAA profile to define and apply the following AAA configuration settings:

- The authentication server to use for 802.1X, MAC, and Captive Portal authentication.
- The accounting server to use for 802.1X, MAC, and Captive Portal authentication.
- Authentication session parameter values, such as the session timeout, inactivity timeout, interim accounting interval, or 802.1X re-authentication interval.
- RADIUS attribute values for NAS-Port and NAS-Identifier attributes.
- MAC address format used when a MAC address is specified in the Calling-Station-ID and Called-Station-ID attributes.

AAA profiles can be used to apply different sets of AAA configuration parameters to different sets of ports. For example, different AAA profiles could be created to point to different RADIUS servers for each authentication method. This would allow the switch to interact with a specific server on one set of ports and interact with a different server on another set of ports.

In addition, an AAA profile can be assigned to a Captive Portal profile to define specific AAA configuration options for Captive Portal authentication. A Captive Portal profile is assigned to a UNP Edge profile and applied when Captive Portal authentication is enabled for the Edge profile.

Configuring AAA Profiles

Use the **aaa profile** command to create a profile name and configure parameter values for that profile. For example:

```
-> aaa profile ap-1
-> aaa profile ap-1 device-authentication mac rad1 rad2
-> aaa profile ap-1 device-authentication 802.1x serv1 serv2 serv3 serv4
-> aaa profile ap-1 device-authentication captive-portal rad3 rad4

-> aaa profile ap-1 accounting 802.1x rad1 rad2 rad3
-> aaa profile ap-1 accounting mac rad1 rad2
-> aaa profile ap-1 accounting captive-portal syslog 10.135.67.99 port 8000

-> aaa profile ap-1 mac inactivity-logout enable
-> aaa profile ap-1 captive-portal inactivity-logout enable interval 600
```

Use the **unp aaa-profile** command to assign an AAA profile to a UNP port or UNP link aggregate. For example:

```
-> unp port 1/1/5 aaa-profile A1
-> unp port 1/2/1-5 aaa-profile A2
-> unp linkagg 10 aaa-profile A3
-> unp linkagg 2-5 aaa-profile A4
```

Use the **captive-portal-profile** command to assign an AAA configuration profile to a Captive Portal Profile. For example:

```
-> captive-portal-profile cp_p1 aaa-profile aaa-p1
```

Use the **show aaa profile** command to display the AAA profile configuration.

For more information about the commands described in this section, see the *OmniSwitch AOS Release 8 CLI Reference Guide*.

Configuring an Authentication Server Down UNP

An authentication server down UNP is used to classify devices attempting to authenticate through UNP ports when the RADIUS server is unreachable. By default, there is no such profile configured for the switch. To create this type of UNP, use the **unp auth-server-down** command.

```
-> unp auth-server-down edge-profile down_unp
```

After a device is classified into the VLAN for this UNP, an attempt to re-authenticate the device is made after a specific period of time (60 seconds by default). To change this time value, use the **unp auth-server-down timeout** command.

```
-> unp auth-server-down edge-profile timeout 120
```

Configuring an authentication server down UNP is highly recommended when MAC or 802.1X authentication is enabled on any UNP port or link aggregate. This is because after a switch reload, the traffic from devices connected to UNP ports and link aggregates reaches the switch and triggers the authentication process before route convergence has completed and the server can be reached.

- If an authentication server down UNP is configured, devices are temporarily learned in that profile and authentication is automatically attempted again after the timeout period expires. This allows time for the server to become reachable from the switch after a reload.
- If an authentication server down UNP is not configured, devices are learned as filtering and will remain in that state. There is no further attempt to authenticate these devices again.

The authentication down UNP and related timer value are applied to all traffic received on all UNP ports in the event the RADIUS server becomes unreachable. To verify if this setting is enabled or disabled, use the **show unp global configuration** command.

Note. When device authentication fails due to an unreachable RADIUS server, an event message is sent to the switch logging utility (swlog). See [Chapter 37, “Using Switch Logging,”](#) for more information.

Configuring UNP Port-Based Functionality

Access Guardian provides network access and QoS on a per-user basis through the framework of the Universal Network Profile (UNP) feature. UNP functionality is enabled and applied on switch ports or link aggregates. Devices connected to a UNP-enabled port or link aggregate are subject to authentication and classification as determined by the UNP port and switch configuration.

By default, UNP functionality is disabled on all switch ports and link aggregates. To enable UNP on a port or link aggregate, use the **unp port** command. For example:

```
-> unp port 1/1/3
-> unp linkagg 10
```

There are three UNP port types supported: edge, bridge, and SPB access. When UNP is initially enabled, the port type is set to “edge” by default. To enable UNP and specify a port type, use the **unp port** command with the **port-type** parameter. For example:

```
-> unp port 1/1/12 port-type bridge
```

```
-> unp linkagg 5 port-type bridge
-> unp port 1/1/13 port-type spb-access
```

To remove the UNP configuration from a port or link aggregate, use the **no** form of the **unp port** command. For example:

```
-> no unp port 1/1/3
-> no unp linkagg 10
```

To change the port type of an existing UNP port, remove the current UNP configuration using the **no unp port** or **no unp linkagg** command then use the **unp port-type** command to set the new port type. For example:

```
-> no unp port 1/12
-> unp port 1/12 port-type bridge
-> no unp linkagg 5
-> unp linkagg 5 port-type bridge
```

Configuring UNP Port Parameters

When UNP is enabled on a port without specifying a port type, the port type is set to “Edge” by default and all traffic is blocked on the port until a UNP port-based configuration is defined. The following table lists all the UNP commands that are used to configure UNP port parameters for the specified type of UNP port. For example:

- The 802.1x and MAC authentication parameters are configurable for all UNP port types (edge, bridge, and SPB), so the “Port Type” field contains “All ports” for these parameters.
- The redirect port bounce parameter is only configurable for a UNP edge port, so the “Port Type” field contains “Edge port” for this parameter.

Command	Description	Port Type
unp redirect port-bounce	Configures the redirect port bounce status for the port. When enabled, a port bounce is triggered upon receipt of Change of Authorization (CoA) or Disconnect request (DM) messages.	Edge port
unp 802.1x-authentication	Configures the status of 802.1X authentication for the UNP port.	All ports
unp 802.1x-authentication pass-alternate	Assigns the name of an existing UNP as an alternate profile. If successful 802.1X authentication does not return a UNP, the device can be classified into this alternate profile.	All ports
unp 802.1x-authentication bypass	Configures whether to bypass 802.1X authentication on the port.	All ports
unp 802.1x-authentication failure-policy	Configures whether to attempt MAC authentication if 802.1X authentication fails or let the port configuration classify the device.	All ports
unp 802.1x-authentication tx-period	Configures the re-transmission time interval for UNP ports on which 802.1X authentication is enabled.	All ports
unp 802.1x-authentication supp-timeout	Configures the amount of time the switch will wait before timing out an 802.1X user attempting to authenticate through the port.	All ports

unp 802.1x-authentication max-req	Configures the maximum number of times the switch will transmit a request for authentication information to an 802.1X user on the port.	All ports
unp mac-authentication allow-eap	Configures whether to attempt 802.1X authentication after MAC authentication passes or fails on a UNP port that has 802.1X bypass enabled.	All ports
unp mac-authentication	Configures the status of MAC authentication for the UNP port.	All ports
unp mac-authentication pass-alternate	Assigns the name of an existing UNP as an alternate profile. If successful MAC authentication does not return a UNP, the device can be classified into this alternate profile.	All ports
unp classification	Configures the status of device classification for the UNP port. When enabled, UNP port and rule classification parameters are applied if device authentication does not provide a UNP name for a device connected to the port.	All port types
unp default-edge-profile unp default-vlan-profile unp default-spb-profile	Assigns the name of an existing UNP as the default profile for the UNP port. If device authentication or classification does not provide a UNP name for a user device, the device can be classified into the default profile.	Edge port Bridge port SPB port
unp port group-id	Assigns a UNP port to a numerical group ID. All UNP ports assigned to the same group ID represent a logical group domain to which specific UNP configuration and classification can be applied.	Edge port
unp unp-customer-domain	Assigns a UNP port to a numerical customer domain ID. Groups UNP ports together in a logical group. Similar to the group ID assignment for Edge ports.	Bridge port SPB port
unp aaa-profile	Assigns the name of an existing AAA configuration profile to a UNP port.	Edge port
unp port edge-template	Assigns the name of an Edge port template to the UNP port. This type of template applies a pre-defined configuration to the port. All of the other commands specified in this table are configurable parameters for the Edge port template.	Edge port
unp direction	Configures whether egress broadcast, unknown unicast, or multicast traffic is allowed on the UNP port.	Edge port Bridge port
unp trust-tag	Configures the option of whether to trust the VLAN ID of a tagged packet to determine how the packet is classified.	All ports
unp vlan	Configures an untagged VLAN-port association between the specified UNP port and VLAN ID.	All ports

Consider the following guidelines when configuring UNP port parameters:

- The UNP names specified with the **unp default-edge-profile**, **unp default-vlan-profile**, **unp default-spb-profile**, **unp 802.1x-authentication pass-alternate**, and **unp mac-authentication pass-alternate**

commands must already exist in the switch configuration. See [“UNP Profiles” on page 31-15](#) for more information.

- The AAA profile configuration applied to a UNP Edge port overrides the global AAA configuration for the switch. See [“Using AAA Configuration Profiles” on page 31-26](#) for more information.
- When an Edge template is assigned to a UNP Edge port, the parameter values defined in the template will override any existing UNP port configuration. In addition, any attempt to explicitly configure a port that is associated with a template is not allowed.
- Enabling both 802.1X and MAC authentication is allowed on the same port, but 802.1X authentication is attempted first unless 802.1X authentication bypass is also enabled for the port (see [“Configuring 802.1x Authentication Bypass” on page 31-31](#)).

For more information about the commands described in this section, see the “UNP Commands” chapter in the *OmniSwitch AOS Release 8 CLI Reference Guide*.

Using Edge Port Templates

A UNP edge port template is a configuration entity that provides flexible assignment of a pre-defined UNP port configuration to specific edge ports. Using an edge port template to configure UNP functionality on a port or link aggregate avoids having to configure each parameter with a separate CLI command. Applying an edge template configures all port-based parameters with a single CLI command.

A UNP edge port template is used to define and apply the following UNP port configuration settings:

- The type of device authentication (802.1X or MAC) to enable on the port.
- Specific 802.1X parameters, such as re-transmission interval, supplicant timeout, or maximum number of times to request authentication information from an 802.1X user.
- 802.1X authentication bypass.
- 802.1X authentication after MAC authentication passes or fails on a UNP port that has 802.1X bypass enabled.
- An 802.1X failure policy to determine if MAC authentication or classification is attempted after 802.1X authentication fails.
- Device classification status to determine if UNP classification rules are used to select an Edge profile.
- A default UNP Edge profile.
- An alternate UNP Edge profile for when successful 802.1X or MAC authentication does not return a UNP name.
- The name of an AAA configuration profile to assign to the port.
- BYOD redirect port bounce status.
- The ID of a logical group of ports to which the port is assigned.
- Trust tag status.
- VLAN IDs used to create an untagged VLAN-port-association with the port.

Configuring Edge Port Templates

Use the **unp edge-template** command to create a template name and configure parameter values for the template. For example:

```
-> unp edge-template et-1
-> unp edge-template et-1 mac-authentication enable
-> unp edge-template et-1 mac-authentication pass-alternate edge-profile edge1
-> unp edge-template et-1 classification enable
-> no unp edge-template et-1

-> unp edge-template et-2 802.1x-authentication enable
-> unp edge-template et-2 classification enable
-> unp edge-template group-id 10
-> no unp edge-template et-2
```

Use the **unp port edge-template** command to assign an AAA profile to a UNP port or UNP link aggregate. For example:

```
-> unp port 1/1/5 edge-template up1
-> unp port 1/2/1-5 edge-template up2
-> unp linkagg 10 edge-template up3
-> unp linkagg 10-50 edge-template up4
```

Use the **show unp edge-template** command to display the UNP Edge port template configuration.

For more information about the commands described in this section, see the *OmniSwitch AOS Release 8 CLI Reference Guide*.

Configuring 802.1x Authentication Bypass

When a device is connected to a UNP port with 802.1X authentication and MAC authentication enabled, the switch first attempts to identify and authenticate the device using EAP frames. If the device does not respond to EAP frames sent by the switch after a configurable number of attempts, then the device is identified as a non-suppliant and undergoes MAC authentication.

In some cases, however, the network administrator may want to apply MAC authentication first to all devices (suppliant or non-suppliant) connected to the UNP port. In other words, the switch does not initiate 802.1x authentication; EAP frames are not sent and any received are ignored.

The advantage to applying MAC authentication first is that the MAC address of the device is initially verified (for example, checked against a RADIUS black list). Based on the outcome of the MAC authentication, the user device is then classified accordingly or can undergo subsequent 802.1x authentication.

To enforce MAC authentication as the initial authentication method for all devices connected to a UNP port, an 802.1x bypass operation is provided. In addition, the bypass operation provides configurable options that are used to specify if subsequent 802.1x authentication is performed on the device based on the results of MAC authentication.

Configuring 802.1x authentication bypass is done using the **unp 802.1x-authentication bypass** and **unp mac-authentication allow-eap** commands. The **unp 802.1x-authentication bypass** command enables or disables the bypass operation. The following **unp mac-authentication allow-eap** command parameters determine if subsequent 802.1x authentication is attempted on the device after MAC authentication:

- **pass**—802.1x authentication is attempted if the device passes the initial MAC authentication. If the device fails MAC authentication, 802.1x authentication is bypassed (EAP frames are ignored) and the device is classified as a non-suppliant.

- **fail**—802.1x authentication is attempted if the device fails the initial MAC authentication. If the device passes MAC authentication, 802.1x authentication is bypassed (EAP frames are ignored) and the device is classified as a non-supplicant.
- **noauth**—802.1x authentication is automatically attempted if there is no MAC authentication available for the port.
- **none** (the default)—802.1x authentication is permanently bypassed. Only MAC authentication is performed and the device is classified as a non-supplicant.

Configuration Guidelines

Consider the following guidelines before configuring 802.1x authentication bypass:

- The 802.1x bypass operation is only supported on UNP ports with 802.1x authentication enabled. See [“Configuring UNP Port-Based Functionality” on page 31-27](#) for more information about configuring the access control mode.
- If a port has supplicants connected and 802.1x bypass is enabled for that port, the supplicants are automatically logged off to undergo authentication according to the enabled bypass configuration.
- When the 802.1x bypass configuration is modified or disabled, any non-supplicant devices are automatically logged off the port. This will free up those devices to undergo the authentication specified by the new bypass configuration.
- If re-authentication is configured for the UNP port and 802.1X bypass is enabled, the MAC authentication followed by 802.1x authentication is initially performed as configured. However, only 802.1x authentication is performed during the re-authentication process, so there is no recheck to see if the MAC address of the user device is restricted.
- Enabling 802.1X bypass is not allowed on UNP ports that are configured with an 8021X failure policy.
- When successful MAC authentication returns a UNP and the 802.1x bypass operation is configured to initiate 802.1x authentication when a device passes MAC authentication, the device is *not* moved into that UNP. Instead, the device is moved into the UNP returned by 802.1x authentication. If 802.1x authentication does not provide such information, the device is moved based on the UNP port-based configuration.
- When 802.1X bypass is enabled and after MAC authentication, the port will be in a waiting state until the 802.1X authentication process complete.

Configuration Example: 802.1X Bypass with MAC Authentication Fail Policy

The following CLI configuration example enables 802.1x authentication bypass on port 2/1 and triggers subsequent 802.1X authentication if the initial MAC authentication process fails:

```
-> unport 2/1 802.1x-authentication bypass enable
-> unport 2/1 mac-authentication allow-eap fail
```

The resulting Access Guardian authentication process for a device connected to UNP port 2/1 is as follows for this example:

- MAC authentication is triggered when the first frame from the new user is received, whether it is an EAP frame or not.
- EAP frames for this user are ignored until MAC authentication completes (RADIUS returns an Access-Accept or a Access-Reject response).

- If the initial MAC authentication passes (that is, Access-Accept), 802.1x authentication is bypassed for this user and all EAP frames are ignored.
- If the initial MAC authentication fails (that is, Access-Reject), 802.1x authentication is attempted for the user. During this transition, the EAP frames are allowed and the switch must force the supplicant to restart a fresh EAP session by sending a multicast Request Identity EAPOL on the port. This is because the supplicant may have already sent an EAPOL Start.

Configuring UNP Port Bandwidth

The following two methods are available to configure and apply port bandwidth parameter values to UNP ports that are assigned to a profile:

- **QoS policy list rules.** A QoS policy list assigned to an Edge, VLAN, or SPB profile applies policy rules to all traffic that is classified into the profile associated with the policy list. For example, the following commands create a QoS policy list with rules to apply rate limiting parameters to all device ports assigned to the “UNP-1” Edge profile:

```
-> policy condition ip_traffic2 source ip 10.10.5.3
-> policy action flowShape maximum bandwidth 10m
-> policy action burst maximum depth 1m
-> policy rule rule2 condition traffic2 action flowShape action burst
-> policy list rate-limit type unp
-> policy list rate-limit rules rule2
-> unp edge-profile UNP-1
-> unp edge-profile UNP-1 qos-policy-list rate-limit
-> unp vlan-mapping 50
```

See [“Configuring QoS Policy Lists” on page 31-43](#) for more information.

- **Profile bandwidth parameters.** Configurable bandwidth parameter values associated with an Edge or VLAN profile (not configurable for an SPB profile) are applied to traffic that is classified into the Edge or VLAN profile. For example, the following commands define profile bandwidth parameters to rate limit traffic on all device ports assigned to the “UNP-1” Edge profile.

```
-> unp edge-profile UNP-1 maximum-ingress-bandwidth 10M
-> unp edge-profile UNP-1 maximum-egress-bandwidth 10M
-> unp edge-profile unp-1 maximum-ingress-depth 1
-> unp edge-profile unp-1 maximum-egress-depth 1
```

See [“Configuring UNP Profiles” on page 31-35](#) for more information.

Consider the following guidelines when configuring UNP port bandwidth:

- The maximum ingress and egress bandwidth values are configured in Kbps or Mbps.
- The maximum ingress and egress depth values are configured in Kbps.
- The default value for the maximum ingress and egress depth settings is calculated by dividing the maximum ingress or egress bandwidth value by 25. For example, if the ingress bandwidth value is set to 500K, then the ingress depth value defaults to 20K (500K/25=20K). However, if this calculation results in a value of 0 or 1, then the default value is set to 2K.
- “Per user” bandwidth profiling is not supported. If there are multiple users authenticating through a port, then the bandwidth limitation of the last user overrides the existing bandwidth limitations, if any.
- Runtime modification of UNP ingress or egress bandwidth is allowed; the modified values are then applied to both new and already authenticated user devices learned on the profile. The new runtime

values become the latest bandwidth values for the profile, so they are applied to all user devices associated with the profile.

- The bandwidth limitation applied on a port through UNP classification is not removed when a user logs out or ages out. An administrator can override the bandwidth limitation through the **qos port** command or by removing the UNP configuration on the port.
- If any port bandwidth parameter value defined for a UNP profile is modified, then the other parameters need to be configured again, otherwise they will be set to their default values. For example, consider a UNP profile with maximum egress bandwidth set to 100M and egress depth set to 10K, where the maximum bandwidth is changed to 200M. In this scenario, only the modified maximum bandwidth is considered, but the egress depth is reset to the default value unless the required value is specifically configured again.
- If port bandwidth values are applied through UNP profile (Edge or VLAN) bandwidth parameters *and* also through a QoS policy list associated with the same profile, then the minimum of both the values is applied on the UNP port.

Multiple User Authentication on the Same Port

If multiple users are authenticated through the same UNP port and are classified with either RADIUS returned attributes or through locally configured classification methods, then the bandwidth associated to the latest authenticated user will override the previous bandwidth associated. If there is no bandwidth associated to the new user, then no rate limitations are enforced and previously set bandwidth is applied to the new authenticated user.

There is no priority between bandwidth limits provided through the **qos port** command or UNP. The latest change will over write the previous bandwidth limitation applied on the port. For example:

Bandwidth Profile	Action
If a user authenticates into a UNP with no UNP bandwidth profile (no bandwidth parameters or QoS policy list to apply rate limitations).	The port bandwidth setting is applied.
If a user authenticates into a UNP with a bandwidth profile (bandwidth parameters or QoS policy list applies rate limitations).	The UNP bandwidth setting overrides the port bandwidth setting.

Note. The same bandwidth behavior applies when the user is authenticated with QoS port bandwidth, QoS port configuration being the latest configuration.

Configuring UNP Port Domains

UNP port domains provide an additional method for segregating device traffic. A domain is identified by a numerical ID, which can be assigned to UNP ports and profile classification rules. By default, all UNP ports and profile rules are assigned to domain 0.

The main benefit of UNP port domains is that they provide the ability to group physical UNP ports or link aggregates into one logical domain. Once a UNP port is assigned to a specific domain ID, only classification rules associated with the same domain ID are applied to that port.

An example of using UNP port domains would be to group UNP ports carrying traffic for a specific customer into the same domain (all Customer A ports are assigned to domain 2). Then assign profiles tailored for that customer to the same domain ID (all profiles for Customer A are assigned to domain 2).

There are two types of domain IDs: a group ID and a customer domain ID. The type of domain ID to use is based on the port and profile type to which the ID is assigned. For example:

- UNP edge ports and profiles are assigned to group IDs.
- UNP bridge ports and VLAN profiles are assigned to customer domain IDs.
- UNP SPB access ports and profiles are also assigned to customer domain IDs.

By default, all UNP edge ports are assigned to group 0 and all UNP bridge and SPB access ports are assigned to customer domain 0. To add additional group or customer domain IDs, use the **unp group-id** command or the **unp customer-domain** command. For example:

```
-> unp group-id 2
-> unp customer-domain 2
```

To assign UNP edge ports to a group ID, use the **unp port group-id** command. For example:

```
-> unp port 1/1/1-3 group-id 2
-> unp linkagg 5 group-id 52
```

To assign UNP bridge or SPB access ports to a customer domain ID, use the **unp unp-customer-domain** command. For example:

```
-> unp port 1/1-3 unp-customer-domain 2
-> unp linkagg 5 unp-customer-domain 5
```

See [“Configuring Classification Rules for UNP Port Domains” on page 31-45](#) for more information.

Configuring UNP Profiles

Universal Network Profiles (UNP) are assigned to host devices through the Access Guardian device authentication process, the application of profile classification rules, or based on the UNP port configuration. There are three types of profiles supported: Edge, VLAN, and Shortest Path Bridging (SPB). The type of profile applied to port traffic is based on the port type. For example:

- Edge profiles classify traffic received on UNP edge ports.
- VLAN profiles classify traffic received on UNP bridge ports.
- SPB service profiles classify traffic received on UNP access ports.

This section provides information about how to configure UNP Edge, VLAN, and SPB profiles.

Configuring a UNP Edge Profile

The following **unp edge-profile** commands are used to create a UNP Edge profile and configure profile attributes that are used to enforce network access control for devices assigned to the profile:

Command	Description
unp edge-profile	Creates an Edge profile and associates the profile with a name.
unp edge-profile qos-policy-list	Assigns a QoS policy list to an Edge profile. If there is no list assigned to a profile, users classified into that profile are granted full access within the profile VLAN domain.

unp edge-profile location-policy	Assigns the name of a location-based policy to the Edge profile. This type of policy defines criteria (such as the slot/port, system name and location) to determine if a device is accessing the network from a valid location.
unp edge-profile period-policy	Assigns the name of a time-based policy to the Edge profile. This type of policy specifies the days and times during which a device can access the network.
unp edge-profile captive-portal-authentication	Configures the status of internal Captive Portal authentication for the profile. When enabled, triggers the Captive Portal authentication process for users classified into the profile.
unp edge-profile captive-portal-profile	Assigns the name of a Captive Portal profile that applies a specific Captive Portal configuration to devices assigned to the Edge profile. This type of profile is applied when Captive Portal is enabled for the Edge profile and overrides the global Captive Portal configuration.
unp edge-profile authentication-flag	Configures the status of the authentication flag for the profile. When enabled, only devices that were successfully authenticated are allowed into the Edge profile.
unp edge-profile mobile-tag	Configures the mobile tagging status for the profile. When enabled, the UNP port to which a device is connected is tagged with the VLAN ID associated with the Edge profile when the device is classified into that profile.
unp edge-profile redirect	Configures the redirect status for the profile. When enabled, the profile honors Change of Authorization (CoA) and Disconnect request (DM) messages to interact with the ClearPass Policy Manager (CPPM) as part of the OmniSwitch BYOD solution.
unp edge-profile maximum-ingress-bandwidth	Configures the maximum amount of bandwidth allocated for ingress traffic on UNP bridge ports assigned to the Edge profile.
unp edge-profile maximum-egress-bandwidth	Configures the maximum amount of bandwidth allocated for egress traffic on UNP bridge ports assigned to the Edge profile.
unp edge-profile maximum-ingress-depth	Configures how much traffic is allowed to burst over the maximum ingress bandwidth limits on UNP edge ports assigned to the Edge profile.
unp edge-profile maximum-egress-depth	Configures how much traffic is allowed to burst over the maximum egress bandwidth limits on UNP edge ports assigned to the Edge profile.
unp vlan-mapping edge-profile	Maps a VLAN ID to an Edge profile. Devices classified into the Edge profile are dynamically assigned into the VLAN associated with the profile.

Consider the following guidelines when configuring UNP Edge profiles:

- Any Edge profile names that will be assigned through RADIUS authentication and/or the CPPM BYOD process must be defined on both the OmniSwitch and the RADIUS and/or CPPM server.
- Edge profile attributes are only applied to device traffic that is received on UNP-enabled edge ports (see “[Configuring UNP Port-Based Functionality](#)” on page 31-27).

- The QoS rules within a policy list are applied to all members of the Edge profile group to enforce access to network resources. Only one policy list is allowed per profile, but multiple profiles may use the same policy list. See [“Configuring QoS Policy Lists” on page 31-43](#) for more information.
- If a device violates a location or time period policy, the device is placed into an unauthorized state, even though it is still assigned to the profile. In this state, a built in QoS policy list is applied to the device to restrict the role of the device.
- Captive Portal authentication is applied as a post-authentication and/or post-classification mechanism to devices assigned to the Edge profile. Captive Portal provides a Web-based authentication mechanism to dynamically change the role-based access (policy list) for a user. See [“Using Captive Portal Authentication” on page 31-48](#) for more information.
- Enabling internal Captive Portal authentication is not allowed on profiles that have the redirect flag enabled. When the redirect flag is enabled, external Captive Portal authentication is triggered for the device. See [“Bring Your Own Devices \(BYOD\) Overview” on page 31-77](#) for more information.
- To ensure proper redirection for devices classified into a redirect Edge profile (redirect flag is enabled), configure the redirection server as the preferred server through AAA commands for MAC and 802.1X authentication. See [“Bring Your Own Devices \(BYOD\) Overview” on page 31-77](#) for more information.
- UNP classification rules can be defined for a UNP Edge profile to provide an additional method for classifying a device into an Edge profile. If authentication is not available or does not return a profile name, classification rules are applied to determine the profile assignment. See [“Configuring UNP Classification Rules” on page 31-45](#) for more information.
- A UNP Edge profile can be configured as a default profile for a UNP edge port. If authentication and classification do not return a profile name, the device is then assigned to the default Edge profile associated with the edge port on which the device was learned. See [“Configuring UNP Port-Based Functionality” on page 31-27](#).

To configure a UNP Edge profile, use the **unp edge-profile** commands and the **unp vlan-mapping edge-profile** command. For example, the following command creates the “guest_user” profile to assign devices to VLAN 500 and apply the rules from the “temp_rules” policy list:

```
-> unp edge-profile guest_user
-> unp edge-profile qos-policy-list temp_rules
-> unp vlan-mapping edge-profile guest_user vlan 500
```

To verify the Edge profile configuration for the switch, use the **show unp edge-profile** command. For more information about profiles, see [“UNP Profiles” on page 31-15](#).

For more information about the **unp** commands described in this section, see the “UNP Commands” chapter in the *OmniSwitch AOS Release 8 CLI Reference Guide*.

Configuring a UNP VLAN Profile

The following **unp vlan-profile** commands are used to create a UNP VLAN profile and configure profile attributes that are used to enforce network access control for devices assigned to the profile:

Command	Description
unp vlan-profile	Creates a VLAN profile and associates the profile with a name and VLAN ID.
unp vlan-profile qos-policy-list	Assigns a QoS policy list to a VLAN profile. If there is no list assigned to a profile, users classified into that profile are granted full access within the profile VLAN domain.
unp vlan-profile mobile-tag	Configures the mobile tagging status for the profile. When enabled, the UNP port to which a device is connected is tagged with the VLAN ID associated with the VLAN profile when the device is classified into that profile.
unp vlan-profile maximum-ingress-bandwidth	Configures the maximum amount of bandwidth allocated for ingress traffic on UNP bridge ports assigned to the VLAN profile.
unp vlan-profile maximum-egress-bandwidth	Configures the maximum amount of bandwidth allocated for egress traffic on UNP bridge ports assigned to the VLAN profile.
unp vlan-profile maximum-ingress-depth	Configures how much traffic is allowed to burst over the maximum ingress bandwidth limits on UNP bridge ports assigned to the VLAN profile.
unp vlan-profile maximum-egress-depth	Configures how much traffic is allowed to burst over the maximum egress bandwidth limits on UNP bridge ports assigned to the VLAN profile.

Consider the following when configuring a VLAN profile:

- The VLAN associated with a profile must already exist in the switch configuration, unless the dynamic VLAN configuration functionality is enabled (see [“Enabling Dynamic VLAN Configuration”](#) on page 31-39).
- VLAN profile attributes are only applied to device traffic that is received on UNP-enabled bridge ports (see [“Configuring UNP Port-Based Functionality”](#) on page 31-27).
- If a standard VLAN ID associated with a VLAN profile is deleted, the profile association with that VLAN ID is still maintained. Any traffic subsequently classified with this profile is filtered unless the UNP port on which the traffic is received is configured with alternate classification methods (see [“Configuring UNP Port Parameters”](#) on page 31-28).
- Specifying a QoS policy list name that is inactive or does not already exist in the switch configuration is allowed. However, the list will remain inactive for the UNP until the list is enabled or configured using the QoS policy list commands (see [“Configuring QoS Policy Lists”](#) on page 31-43).
- A UNP VLAN profile can be configured as a default profile for a UNP bridge port. If authentication and classification do not return a profile name, the device is then assigned to the default VLAN profile associated with the bridge port on which the device was learned. See [“Configuring UNP Port-Based Functionality”](#) on page 31-27.

To configure a UNP VLAN profile, use the **unp vlan-profile** command. For example, the following command creates the “guest_user” profile to assign devices to VLAN 500 and applies the rules from the “temp_rules” policy list:

```
-> unnp vlan-profile guest_user vlan 500 qos-policy-list temp_rules
```

To verify the VLAN profile configuration for the switch, use the **show unnp vlan-profile** command. For more information about profiles, see “UNP Profiles” on page 31-15.

For more information about the **unnp** commands described in this section, see the “UNP Commands” chapter in the *OmniSwitch AOS Release 8 CLI Reference Guide*.

Enabling Dynamic VLAN Configuration

When creating a UNP VLAN profile, it is possible to specify the VLAN ID of a VLAN that does not exist in the switch configuration. The UNP feature provides the ability to enable dynamic VLAN configuration, which allows “on the fly” configuration of VLANs as they are needed.

When dynamic VLAN configuration is enabled and a profile is created with a VLAN that does not exist, UNP will create that VLAN at the time the profile is created. By default, dynamic VLAN configuration is disabled for the switch. To enable this functionality, use the **unnp dynamic-vlan-configuration** command.

```
-> unnp dynamic-vlan-configuration enable
```

Use the **disable** option with the **dynamic-vlan-configuration** command to disable dynamic configuration.

```
-> unnp dynamic-vlan-configuration disable
```

Dynamic VLAN configuration is a global UNP setting that applies to all profiles. To verify if this setting is enabled or disabled, use the **show unnp global configuration** command.

Consider the following when enabling dynamic VLAN configuration:

- The VLAN status and other port (non-UNP port) assignments are configurable using standard VLAN commands. In addition, the STP status of the VLAN is configurable and enabled by default when the dynamic VLAN is created.
- A dynamic VLAN cannot be deleted using standard VLAN commands (**no vlan *vlan_id***).
- UNP dynamic VLANs are identified as a separate type of VLAN. The **vlan show** commands will display this type with the default name of “UNP-DYN-VLAN” and the designated type as “UNP Dynamic Vlan”. For example:

```
-> show vlan 450
Name                : UNP-DYN-VLAN,
Type                 : UNP Dynamic Vlan,
Administrative State : enabled,
Operational State   : disabled,
IP Router Port      : disabled,
IP MTU               : 1500
```

- Dynamic VLANs are not saved in the “! VLAN:” section of the switch configuration file (**boot.cfg**). However, the **unnp** commands to enable dynamic VLAN configuration and create the UNP are saved in the “! DA-UNP:” section of **boot.cfg** (see the following sample **boot.cfg** file). As a result, the VLAN is created again on the next switch bootup.

```
-> show configuration snapshot vlan
! VLAN:
vlan 1 admin-state enable
vlan 451 admin-state enable
vlan 777 admin-state enable
vlan 887-888 admin-state enable

-> show configuration snapshot da
```

```
! DA-UNP:
unp dynamic-vlan-configuration enable
unp vlan-profile temp1 vlan 450
unp vlan-profile unpTemp vlan 10
unp vlan-profile unpTemp2 vlan 10
unp classification mac-address 00:00:00:00:00:01 vlan-profile unpTemp2
unp classification mac-address 10:22:33:44:55:66 vlan-profile unpTemp2
unp classification ip-address 1.1.1.2 mask 255.0.0.0 vlan-profile unpTemp2
unp port 1/1/11 port-type bridge
unp port 1/1/11 802.lx-authentication enable
unp port 1/1/11 classification enable
unp port 1/1/12 port-type bridge
unp port 1/1/12 mac-authentication enable
unp port 1/1/12 classification enable
```

Enabling Dynamic VLAN Profile Configuration

The UNP feature provides the ability to enable dynamic VLAN profile configuration, which allows “on the fly” configuration of profiles when specific traffic conditions occur. By default, dynamic profile configuration is disabled for the switch. To enable this functionality, use the **unp dynamic-profile-configuration** command. For example:

```
-> unp dynamic-profile-configuration enable
```

Use the **disable** option with the **dynamic-profile-configuration** command to disable this functionality. For example:

```
-> unp dynamic-profile-configuration disable
```

Dynamic profile configuration is a global UNP setting that is applied to traffic on any UNP bridge port that is configured to trust the VLAN tag of the incoming packets. To verify if this setting is enabled or disabled, use the **show unp global configuration** command.

Consider the following when enabling dynamic profile configuration:

- A profile is only dynamically created if the trust VLAN tag is enabled for the UNP bridge port and the packet VLAN tag matches an MVRP VLAN ID that is not assigned to a UNP or there is no matching VLAN ID in the switch configuration.
- Dynamically created profiles are saved in the **boot.cfg** file for the switch.
- By default, dynamically created VLAN profiles are automatically named **dynamic_profile_vlan_id**, where the VLAN ID is the ID of the VLAN contained in the packet tag.
- After the dynamic profile is created, changing the VLAN profile name, associated VLAN ID, or the QoS policy list is allowed. To avoid any confusion, change the profile name if the VLAN ID associated with the profile has changed.
- When the dynamic profile configuration option is enabled along with the dynamic VLAN configuration option, if the dynamically created profile refers to a VLAN that is an MVRP VLAN, then the MVRP VLAN is automatically converted to a dynamic UNP VLAN (UNP-DYN-VLAN).

Configuring a UNP SPB Profile

The following **unp spb-profile** commands are used to create a UNP Shortest Path Bridging (SPB) service-based profile and configure profile attributes that are used to enforce network access control for devices assigned to the profile:

Command	Description
unp spb-profile	Creates an SPB profile and associates the profile with a name, a VLAN tag value, a Service Instance ID (I-SID), and a Backbone VLAN (BVLAN) ID. The VLAN tag, I-SID, and BVLAN values are used to define a Service Access Point (SAP) for profile traffic.
unp spb-profile qos-policy-list	Assigns a QoS policy list to an SPB profile. If there is no list assigned to a profile, users classified into that profile are granted full access within the profile service domain.
unp spb-profile multicast-mode	Configures the multicast replication mode (head-end or tandem) for the SPB service that is associated with the SPB profile. The multicast mode determines how non-unicast packets are replicated through the SPB backbone network.
unp spb-profile vlan-xlation	Configures the status of VLAN translation for egress traffic associated with the SPB profile. When enabled, the VLAN tags for profile traffic are processed according to the settings for the SAP on which the frames will egress, not according to the settings for the SAP on which the frames were received.
unp spb-profile mobile-tag	Configures the mobile tagging status for the profile. When enabled, the UNP port to which a device is connected is tagged with the BVLAN ID associated with the SPB profile when the device is classified into that profile.

Consider the following when configuring an SPB service-based profile:

- SPB profile attributes define a SAP for device traffic received on UNP-enabled SPB access ports (see [“Configuring UNP Port-Based Functionality” on page 31-27](#)).
- The VLAN tag value indicates whether the VLAN tag information from the classified packets is used to assign the traffic to a SAP or if specific single or double-tag values are used to assign the traffic to a SAP. Specify one of the following VLAN tag values for the profile:

0 (zero)	The VLAN tag of the packet is used to determine the SAP encapsulation value. Setting the profile tag value to zero has the same result as enabling trust VLAN tag for the UNP SPB access port.
Outer VLAN tag	The outer VLAN tag value to use for the SAP encapsulation value.
Inner and outer VLAN tags	The inner and outer VLAN tag values to use for the SAP encapsulation value.

- If classified traffic is untagged, then zero is used for the SAP encapsulation value (for example, 1/2:0).
- If the I-SID value specified does not exist in the switch configuration, the service is dynamically created first then the SAP is dynamically created and associated with this service.
- The BVLAN associated with an SPB service profile must already exist in the switch configuration.

- If the VLAN tag value of the classified traffic does not match the tag value specified in the profile, UNP will check to see if the trust VLAN tag option is enabled for the UNP SPB access port. If so, a SAP is assigned using the VLAN tag values of the traffic. If not, the traffic is learned as filtering on the UNP port.
- The default setting for the SPB multicast mode is the head-end mode.
 - When the head-end multicast mode is used, a non-unicast packet received on an SPB access port is replicated once for each receiver in the provider backbone bridge (PBB) network using its unicast base MAC (BMAC) address.
 - When the tandem multicast mode is used, a non-unicast packet received on an SPB access port is replicated once at each node using the multicast group address.
- Specifying a QoS policy list name that is inactive or does not already exist in the switch configuration is allowed. However, the list will remain inactive for the UNP until the list is enabled or configured using the QoS policy list commands (see [“Configuring QoS Policy Lists” on page 31-43](#)).
- A UNP SPB profile can be configured as a default profile for a UNP SPB access port. If authentication and classification do not return a profile name, the device is then assigned to the default SPB profile associated with the UNP SPB access port on which the device was learned. See [“Configuring UNP Port-Based Functionality” on page 31-27](#).

To configure a UNP SPB service profile, use the **unp spb-profile** command. For example, the following command creates the “vNP1” profile to assign device traffic tagged with VLAN 10 to service 1500 bound to BVLAN 500 and apply the rules from the “ServerA_rules” policy list:

```
-> unp spb-profile vNP1 tag-value 10 isid 1500 bvlan 500 qos-policy-list
ServerA_rules
```

The following command example changes the multicast replication mode and enables egress VLAN translation for the service profile:

```
-> unp spb-profile spb3 tag-value 200 isid 1500 bvlan 4002 multicast-mode tandem
vlan-xlation enable
```

To verify the UNP SPB service profile configuration for the switch, use the **show unp spb-profile** command. For more information about profiles, see [“UNP Profiles” on page 31-15](#).

For more information about the **unp** commands described in this section, see the “UNP Commands” chapter in the *OmniSwitch AOS Release 8 CLI Reference Guide*.

Configuring QoS Policy Lists

One of the attributes of UNP Edge, VLAN, and SPB profiles specifies the name of a list of QoS policy rules. This list is applied to a user device when the device is initially assigned to the profile. Using policy lists allows the administrator to associate a group of users to a set of QoS policy rules.

To create a UNP policy list, use the **policy list** command to specify a list name and then use the **policy list rules** command to specify the names of one or more existing QoS/ACL policy rules to add to the list. For example, the following commands create two policy rules and associates these rules with the “temp-rules” list:

```
-> policy condition c1 802.1p 5
-> policy action a1 disposition drop
-> policy rule r1 condition c1 action a1
-> policy condition c2 source ip 10.5.5.0
-> policy action a2 disposition accept
-> policy rule r2 condition c2 action a2
-> policy list temp_rules type unp
-> policy list temp_rules rules r1 r2
-> qos apply
```

Note the following guidelines when configuring QoS policy rules and lists:

- A default policy list exists in the switch configuration. Rules are added to this list when the rule is created. A rule can belong to multiple policy lists. As a result, the rule remains a member of the default list even when it is subsequently assigned to additional lists.
- Each time a rule is assigned to a policy list, an instance of that rule is created. Each instance is allocated system resources. To exclude a rule from the default policy list, use the **no default-list** option of the **policy rule** command when the rule is created. For example:

```
-> policy rule r1 condition c1 action a1 no default-list
```

- Up to 32 policy lists (including the default list) are supported per switch. Only one policy list per UNP is allowed, but a policy list can be associated with multiple profiles.
- If a rule is a member of multiple policy lists but one or more of these lists are disabled, the rule is still active for those lists that are enabled.
- If the QoS status of an individual rule is disabled, then the rule is disabled for all policy lists, even if a list to which the policy belongs is enabled.
- Policy lists are not active on the switch until the **qos apply** command is issued.

Use the **show policy list** command to display the QoS policy rule configuration for the switch.

Dynamically Changing the Policy List Assignment (User Role)

The QoS policy list assigned to a UNP Edge profile determines the initial role (network access) for a user device classified into the profile. This role can be dynamically changed for the user through the Captive Portal authentication mechanism, when a different policy list is returned for the user from a RADIUS or ClearPass Policy Manager (CPPM) server, or when the user is placed into a Captive Portal pre-login, unauthorized, or quarantined state.

Configuring an Explicit Policy List

When the switch assigns a user device to one of the restricted role states (unauthorized, Quarantine Manager, or Captive Portal pre-login), a built-in policy list associated with the restricted role is applied to

the user. To override the built-in policy list with an explicitly configured policy list, use the **unp restricted-role policy-list** command. For example:

```
-> unp restricted-role unauthorized policy-list unauth1
-> unp restricted-role qmr policy-list quarantined1
-> unp restricted-role cp-prelogin policy-list cplogin1
```

When an explicit policy list assignment is removed, the switch reverts back to using the built-in policy list associated with the restricted role state.

Use the **show unp restricted-role** command to display the explicit policy list configuration for restricted roles.

Configuring a User-defined Role

A user-defined role is used to define a list of conditions that a device must match and a QoS policy list name that is applied to devices matching the specified conditions. When the current context of a user device matches all of the role conditions, then the policy list associated with the role is applied to the device.

Only one user-defined role per user is allowed because only one QoS policy list per user is allowed. However, every time the user context changes for a device, all the user-defined roles are checked to see if there is a role that matches the current user context.

A user-defined role consists of the following components:

- A role name.
- A precedence value used to determine precedence among other user-defined rules. The valid precedence range is 1 (lowest) through 255 (highest).
- One or more of the following conditions:
 - The name of a UNP Edge profile to which the user must belong.
 - The device is not authenticated.
 - The type of authentication (802.1X or MAC) the device successfully passed or failed.
 - The device is in a Captive Portal post-login state.
- The name of an existing QoS policy list.

To configure a user-defined role, use the **unp user-role** command. For example:

```
-> unp user-role role1
-> unp user-role role2 precedence 255
-> unp user-role role1 policy-list role1-list
-> unp user-role role1 edge-profile edge1
-> unp user-role role1 authentication-type 8021x
-> unp user-role role1 cp-status-post-login
```

Configuring UNP Classification Rules

UNP classification rules are defined and associated with UNP Edge, VLAN, and SPB profiles to provide an additional method for classifying a device into a profile. If authentication is not available or does not return a profile name for whatever reason, classification rules are applied to determine the profile assignment.

The following table lists the classification rules that are supported, the **unp classification** command that is used to configure each rule, and the UNP profile that supports each rule:

Precedence Step/Rule	Command	Supported Profile
1. Port	unp classification port	Edge profile
2. Group ID	unp classification group-id	Edge profile
3. MAC address	unp classification mac-address	All profiles
4. MAC OUI	unp classification mac-oui	Edge profile
5. MAC address range	unp classification mac-address-range	All profiles
6. LLDP for IP Phones	unp classification lldp med-endpoint ip-phone	Edge profile
7. Authentication Type	unp classification authentication-type	Edge profile
8. IP address	unp classification ip-address	All profiles
9. VLAN tag	unp classification vlan-tag	All profiles

For example, the following command is used to configure a MAC address range rule and assign that rule to an existing UNP Edge profile named “Engineering”:

```
-> unp classification mac-address-range 00:11:22:33:44:55 00:11:22:33:44:66
    edge-profile Engineering
```

If the source MAC address of a device falls within the specified range of the example rule, then the device is classified into the “Engineering” profile and assigned to the VLAN associated with that profile.

The VLAN tag rule can be combined with other rules to include the tag as a required parameter to match for the rule. For example, to include the VLAN tag with a MAC address rule, use the **unp classification mac-address rule** command with the **vlan-tag** option:

```
-> unp classification mac-address 00:00:2a:33:44:01 vlan-tag 10 vlan-profile
    serverA
```

In this example, a device is classified with UNP “serverA” if the source MAC address of the device is “00:00:2a:33:44:01” and device packets are tagged with VLAN 10.

When a VLAN tag rule is combined with another rule, the combined rule takes precedence over the rule that does not specify a VLAN tag. For example, a rule that specifies a MAC address and a VLAN tag takes precedence over a rule that specifies only a MAC address.

Configuring Classification Rules for UNP Port Domains

The UNP customer domain ID and the group ID are assigned to UNP ports to form a logical group of ports to which classification rules are applied. When a classification rule is configured, the **unp-customer-domain** or **group-id** parameters specify the group of ports to which the rule is applied. The type of parameter to use is based on the type of profile configured.

- The **unp-customer-domain** parameter is configurable for rules that classify traffic into a UNP VLAN or SPB profile. The classification rules are then applied only to UNP bridge and SPB access ports that are assigned to the specified customer domain ID. For example, the following commands configure classification rules that are applied only to UNP bridge or SPB access ports that are assigned to customer domain IDs 10, 5, and 2:

```
-> unp classification vlan-tag 100 unp-customer-domain 10 vlan-profile
serverA_unp
-> unp classification ip-address 10.1.1.1 mask 255.0.0.0 unp-customer-domain 5
spb-profile vm-1
-> unp classification mac-address 00:00:2a:33:44:01 unp-customer-domain 2 vlan-
profile serverB_unp
```

- The **group-id** parameter is configurable for rules that classify traffic into UNP Edge profiles. The classification rules are then applied only to UNP edge ports that are assigned to the specified group ID. For example, the following commands configure classification rules that are applied only to UNP edge ports that are assigned to group IDs 10 and 20:

```
-> unp classification group-id 10 edge-profile myProfile1
-> unp classification ip-address 10.0.0.2 group-id 1 edge-profile myProfile1
-> unp classification mac-address 00:11:22:33:44:55 group-id 1 vlan-tag 200
edge-profile myProfile1
```

See [“Configuring UNP Port Domains” on page 31-34](#) for more information.

Configuring Binding Rules for UNP Edge Profiles

A binding rule defines a combination of one or more individual rules, all of which a device has to match. The following binding rule combinations are configurable only for UNP Edge profiles and are listed in the order of precedence:

- 1 Port + MAC address + IP address + VLAN tag
- 2 Port + MAC address + VLAN tag
- 3 Port + IP address + VLAN tag
- 4 Group ID + MAC address + IP address + VLAN tag
- 5 Group ID + MAC address + VLAN tag
- 6 Group ID + IP address + VLAN tag

The precedence order of binding rules is used to determine precedence among only binding classification rules. However, all binding rules take precedence over all individual rules. So if a device matches both an individual rule and a binding rule, the device is classified into the profile associated with the binding rule.

The same commands used to configure individual classification rules are also used to configure binding rule combinations. For example, the **unp classification mac-address** command is used in the following example to configure a binding rule that combines a MAC address rule, an IP address rule, and a port rule:

```
-> unp classification mac-address 00:11:22:33:44:55 ip-address 10.0.0.20 mask
255.255.0.0 port 1/1/1 edge-profile EdgeProf-1
```

If the source MAC address, source IP address, *and* port of a device matches the MAC address, IP address, and port defined in the example binding rule, then the device is classified into the “EdgeProf-1” profile and assigned to the VLAN associated with that profile.

Configuring Extended Classification Rules for UNP Edge Profiles

An Extended classification rule defines a list of individual rules and assigns the list a name and a precedence value. A device must match all of the rules specified in the extended rule list. This type of rule is configurable only for UNP Edge profiles.

The **unp classification-rule** command is used to create an extended rule and set the precedence value for the rule. The following commands are used to define classification rules and assign the rules to the extended rule name:

Precedence Step/Rule	Command
1. Port	unp classification-rule port
2. Group ID	unp classification-rule group-id
3. MAC address	unp classification-rule mac-address
4. MAC OUI	unp classification-rule mac-oui
5. MAC address range	unp classification-rule mac-address-range
6. LLDP for IP Phones	unp classification-rule lldp med-endpoint ip-phone
7. Authentication Type	unp classification-rule authentication-type
8. IP address	unp classification-rule ip-address
9. VLAN tag	unp classification vlan-tag

For example, the following commands create an extended classification rule named “ext-r1” with the precedence value set to 255 and assign the rule to a UNP Edge profile named “corporate”:

```
-> unp classification-rule ext-r1 precedence 255
-> unp classification-rule ext-r1 edge-profile corporate
```

Next, the following commands define a port rule and an authentication type rule and assign the rules to the “ext-r1” extended rule:

```
-> unp classification-rule ext-r1 port 1/1/10
-> unp classification-rule ext-r1 authentication-type 8021x
```

Note that the “ext-1” rule combines a port rule and an authentication type rule. This combination of rules is not allowed in a binding rule configuration.

The precedence value assigned to an extended classification rule is used to determine precedence among only extended classification rules. However, all extended rules take precedence over all individual and all binding rules. So if a device matches a binding rule (or an individual rule) and an extended rule, the device is classified into the profile associated with the extended rule.

Use the **show unp classification** and **show unp classification-rule** commands to verify the UNP classification rule configuration for the switch. For more information about UNP rules, see “UNP Classification Rules” on page 31-17.

Using Captive Portal Authentication

Captive Portal authentication is a mechanism by which user credentials are obtained through Web pages and authenticated through a RADIUS server. If the authentication is successful, the RADIUS server may return a role (policy list) that is applied to traffic from the user device. The OmniSwitch implementation supports an internal Captive Portal mechanism. An internal Web server on the local switch presents Captive Portal Web pages to obtain user credentials.

Internal Captive Portal authentication is a configurable option for a UNP Edge profile that is applied after a user is assigned to the profile (after the initial 802.1X or MAC authentication or classification process). Captive Portal provides a secondary level of authentication that is used to apply a new role (QoS policy list) to the user.

- The RADIUS server returns the name of a QoS policy list or the name of a UNP Edge profile that specifies a policy list name.
- A Captive Portal authentication pass configuration specifies a QoS policy list name and a UNP Edge profile name that is assigned to the user device if the RADIUS server does not return a list or profile name.

The method for determining which QoS policy list is applied is based on the following precedence in descending order:

- 1** A policy list returned from the RADIUS server.
- 2** A domain specific policy list specified in the Captive Portal authentication pass configuration of a Captive Portal profile.
- 3** A policy list specified in the Captive Portal authentication pass configuration of a Captive Portal profile.
- 4** A domain specific policy list specified in the global Captive Portal authentication pass setting for the switch.
- 5** A policy list specified in the global Captive Portal authentication pass setting for the switch.
- 6** A policy list associated with a UNP Edge profile returned from the RADIUS server.
- 7** A policy list associated with a domain specific UNP Edge profile that is specified in the global Captive Portal authentication pass setting for the switch.
- 8** A policy list associated with a UNP Edge profile that is specified in the global Captive Portal authentication pass setting for the switch.

An external, guest Captive Portal authentication mechanism is provided through the Access Guardian OmniSwitch integration with the ClearPass Policy Manager (CPPM). See [“Bring Your Own Devices \(BYOD\) Overview” on page 31-77](#) for more information.

This section provides the following information regarding configuring and using the OmniSwitch internal Captive Portal mechanism:

- [“Configuration Tasks and Guidelines” on page 31-49](#)
- [“Quick Steps for Configuring Captive Portal Authentication” on page 31-50](#)
- [“Using Captive Portal Configuration Profiles” on page 31-51](#)
- [“Customizing Captive Portal Web Pages” on page 31-52](#)

- [“Authenticating with Captive Portal” on page 31-54.](#)

Configuration Tasks and Guidelines

Consider the following tasks and guidelines when configuring the internal Captive Portal feature:

- **Define and map the RADIUS server to use for internal Captive Portal authentication.** The switch needs to know which RADIUS server to access to validate user credentials received through the Captive Portal Web pages. This is done through the AAA feature on the switch. See [“Setting Authentication Parameters for the Switch” on page 31-24](#) for more information
- **Enable the AAA session timer for Captive Portal.** The session timer determines the amount of time a Captive Portal login session can remain active. *By default, this timer is disabled and must be enabled for Captive Portal sessions.* When enabled, the session timeout value defaults to 12 hours. To enable the session timer and change the timer value, if necessary, use the [aaa session-timeout](#) command.
- **Configure additional Captive Portal session parameters.** Default parameter values are in place to determine specific settings that apply to Captive Portal sessions, such as the number of login attempts allowed and an inactivity time limit. It is only necessary to change these global settings if the default values are not sufficient. See [“Configuring Authentication Session Parameters” on page 31-25](#) for more information.
- **Configure a Captive Portal redirect URL.** The switch responds to initial HTTP/HTTPS requests from the user with a redirect URL. By default, this URL is set to “captive-portal.com”. To change the redirect URL, use the [captive-portal name](#) command. To replace the default certificate with a well-known CA certificate, see [“Replacing the Captive Portal Certificate” on page 31-52.](#)
- **Configure a Captive Portal IP address.** A user device contacts the DNS server to resolve the Captive Portal redirect URL and receives the Captive Portal IP address. This address must be configured on the switch and match the address returned from the DNS server. Use the [captive-portal ip-address](#) command to configure this address for the switch.

Note. Make sure the DNS server configuration reflects the same Captive Portal redirect URL name and IP address that is configured for the OmniSwitch.

- **Configure a custom proxy port number for Captive Portal sessions.** Optionally, use the [captive-portal proxy-server-port](#) command to specify a proxy port number other than 8080 (the default).
- **Configure a UNP Edge profile with Captive Portal authentication enabled.** Captive Portal is triggered when a user device is classified into an Edge profile on which Captive Portal authentication is enabled. For more information, see [“Configuring a UNP Edge Profile” on page 31-35.](#)
- **Assign the QoS policy list to change the user role.** Captive Portal is a post-authentication and/or classification process that is used to dynamically change the user role (QoS policy list applied to the user). After the user successfully logs in, the RADIUS server returns a new policy list or UNP Edge profile to apply to the user device. If the RADIUS server does not return a policy list or profile name, then the QoS policy list or Edge profile name specified through the [captive-portal authentication-pass](#) command is used instead. This command can also be used to specify a domain-specific policy (the policy list or UNP Edge profile is only applied to user devices from a specific domain).
- **Configure a redirect URL for successful Captive Portal login.** Optionally, use the [captive-portal success-redirect-url](#) command to redirect a user to a specific site after the user successfully logs in through the Captive Portal session. By default, no Captive Portal success redirect URL is configured.
- **Make sure that a standard browser is available on the client device.** No specialized client software is required. When a device is classified into a UNP Edge profile that has Captive Portal enabled, the

user device is placed into a pre-login role. In this role the user is allowed to contact a DHCP server to obtain an IP address and contact a DNS server to resolve the Captive Portal URL to get the Captive Portal IP address, which is associated with the internal Web server on the switch. See [“Authenticating with Captive Portal” on page 31-54](#) for more information.

Quick Steps for Configuring Captive Portal Authentication

The following procedure provides a brief tutorial for setting up the OmniSwitch implementation of Captive Portal authentication. For additional configuration tutorials, see the Captive Portal application examples on [page 31-62](#) and [page 31-64](#) in the “Access Guardian Application Examples” section.

- 1 Configure the RADIUS server to use for internal Captive Portal authentication. For example:

```
-> aaa radius-server cp-auth host 10.135.60.44 hash-key secret retransmit 3
timeout 2 auth-port 1812 acct-port 1813
-> aaa device-authentication captive-portal cp-auth
```

- 2 Configure the RADIUS server with the IP address of the OmniSwitch and the same shared secret that was assigned through the AAA RADIUS server configuration in Step 1.

- 3 Add the user name and password details in the RADIUS server.

- 4 Enable the Captive Portal session timer to determine the amount of time the user session remains active after a successful login (the default time is set to 12 hours). For example:

```
-> aaa captive-portal session-timeout enable
```

- 5 Configure a UNP Edge profile and enable Captive Portal authentication on the profile. For example:

```
-> unp edge-profile Captive-Portal
-> unp edge-profile Captive-Portal captive-portal-authentication enable
-> unp vlan-mapping edge-profile Captive-Portal vlan 111
```

- 6 Enable UNP functionality on the port that will connect the user device to the OmniSwitch and assign the profile created in Step 5 as the default profile for the port. For example:

```
-> unp port 1/1/20
-> unp port 1/1/20 default-edge-profile Captive-Portal
```

- 7 Configure the Captive Portal redirect URL and Captive Portal IP address. For example:

```
-> captive-portal name captive-portal.com
-> captive-portal ip-address 10.123.0.1
```

- 8 Configure the DNS servers with a mapping between “captive-portal.com” and the 10.123.0.1 IP address. The user device resolves this URL through access to the DNS server to get the Captive Portal IP address, which is mapped to the internal Web server on the OmniSwitch.

Verifying the Captive Portal Setup

- 1 Make sure the client has received an IP address from the DHCP server.
- 2 When the client opens a Web browser and attempts to access any URL, the client is prompted with the Captive Portal login page. This is the Web page presented by the internal server on the OmniSwitch.
- 3 When the client enters the appropriate login credentials and clicks on the “Submit” button on the login page, the client is presented with the Captive Portal status page. This page indicates that the login was successful and the remaining session time.

- 4 Use the **show unip edge-user status** command on the OmniSwitch to display the status of the Access Guardian classification and Captive Portal authentication process for the MAC address of the client.

Using Captive Portal Configuration Profiles

A Captive Portal profile is a configuration entity that provides flexible assignment of Captive Portal configuration parameters to devices classified into specific UNP Edge profiles. However, this type of profile is only valid when assigned to Edge profiles on which Captive Portal authentication is enabled.

When a Captive Portal profile is applied to a UNP Edge profile, the parameter values defined in the Captive Portal profile override the global Captive Portal parameter values configured for the switch. If there is no Captive Portal profile associated with an Edge profile, then the global Captive Portal configuration is applied.

Use a Captive Portal profile to define and apply the following Captive Portal configuration settings for user sessions associated with a specific Edge profile:

- The name of an AAA profile to define specific device authentication configuration options, such as which servers to use for Captive Portal authentication and parameter values for session timers and RADIUS attributes. If there is no AAA profile assigned, the global AAA configuration for the switch is used.
- A URL to which user devices are redirected when Captive Portal authentication is successful.
- The number of login attempts allowed for the Captive Portal session.
- The name of the QoS policy list or UNP Edge profile to apply when Captive Portal authentication is successful but the RADIUS server did not return a policy list or profile name.

Captive Portal profiles can be used to apply a custom Captive Portal configuration to different sets of user devices based on the Edge profile assignment for the device.

Configuring Captive Portal Profiles

Use the **captive-portal-profile** command to create a profile name and configure parameter values for that profile. For example:

```
-> captive-portal-profile cp_p1
-> captive-portal-profile cp_p1 aaa-profile aaa_p1
-> captive-portal-profile cp_p1 authentication-pass realm prefix domain asia-
  pacific policy-list list1

-> captive-portal-profile cp-p2 retry-count 5
-> captive-portal-profile cp-p2 authentication-pass edge-profile ep-1
-> captive-portal-profile cp-p2 authentication-pass edge-profile-change enable
-> captive-portal-profile cp-p2 success-redirect-url http://server-1.com/
  pass.html
```

Captive Portal profiles are only valid for UNP Edge profiles on which Captive Portal authentication is enabled. Use the **unip edge-profile captive-portal-authentication** command to enable Captive Portal authentication for an Edge profile. For example:

```
-> unip edge-profile unip-edgel captive-portal-authentication enable
```

Use the **unip edge-profile captive-portal-profile** command to assign a Captive Portal configuration profile to a UNP Edge profile. For example:

```
-> unip edge-profile unip-edgel captive-portal-profile cp_p1
```

Use the **show captive-portal profile-name** command to display the Captive Portal profile configuration.

For more information about the commands described in this section, see the *OmniSwitch AOS Release 8 CLI Reference Guide*.

Replacing the Captive Portal Certificate

By default, the OmniSwitch uses a built-in, self-signed certificate for Captive Portal. The certificate is named “default_cportalCert.pem” and is stored in the “/flash/switch” directory on the switch. To replace the default certificate with a well known CA certificate, use the following steps:

- 1 Backup the existing default certificate.

```
-> cp default_cportalCert.pem default_cportalCert.pem.old
```

- 2 Rename the new well known CA certificate file to “default_cportalCert.pem”.

- 3 Copy the certificate file to the “/flash/switch” directory.

- 4 Use the **captive-portal name** command to reload the Web configuration (use the CN name as specified in the new certificate):

```
-> captive-portal name CN_name
```

- 5 Attempt a captive portal log in to verify the change.

Note. The certificate must be in the x509 format. To generate an x509 formatted certificate (.pem), perform the following on a Linux or Unix machine:

- 1 Have the private key and the CA signed certificate available.
 - 2 Issue the "`cat privateKey ca_certificate | tee switch_cert_file`" (i.e default_cportalCert.pem) command.
-

Customizing Captive Portal Web Pages

The Web pages that Captive Portal presents to users are stored in the “/flash/switch/captive_portal/release_files/” directory on the switch. To present the user with customized Web pages:

- 1 Create a folder in the same path as the “release_files” folder and name the new folder “custom_files” (for example “/flash/switch/captive_portal/custom_files”).

- 2 Copy the “assets” and “templates” folders found under “/flash/switch/captive_portal/release_files/” to the “custom_files” folder.

- 3 Modify the contents in the copied folders to create custom Web pages.

- 4 Once the custom files are created with the images and information the file type requires, download the files to the “/flash/switch/captive_portal/custom_files” folder.

- 5 Enable Captive Portal customization using the **captive-portal customization** command.

```
-> captive-portal customization enable
```

When a Captive Portal session is initiated, the switch checks to see if there is a “custom_files” folder; if so, then the files in that folder are incorporated presented to the user. If there are no files found or the “custom_files” folder does not exist, the default Web page components found in the “release_files folder are incorporated and presented to the user.

Consider the following guidelines when customizing Captive Portal Web page components:

- The “release_files” folder is overwritten each time the switch reboots; **DO NOT** modify the files in this folder for custom use.
- The folders "assets" and "templates" under the “/flash/switch/captive_portal/custom_files/” directory are used to create and display Web pages to Captive Portal users when the switch reboots or at runtime when Captive Portal customization is enabled for the switch, if the “custom_files” folder exists.
- Anything in the custom "assets" folder is statically served by the internal Web server on the switch whenever they are requested. These pages are typically .css files, javascript files, or the acceptable use policy and are linked to files in the custom "templates" folder.
- The custom "templates" folder contains the Web pages that are dynamically served to users depending on the Captive Portal state of each user. The file names in this folder must not be changed. The login form field names and form action in these pages must not be changed. The variables in these pages, as denoted by "<?=\$(name)?>", are substituted in place by the internal Web server.
- Filenames are case sensitive. When creating a custom file, ensure that the filename matches the filename exactly as shown in the “release_files” folder.
- Enabling Captive Portal customization automatically triggers the use of the custom Web pages at runtime. There is no need to reboot the switch to trigger this action.

The following is an example of a customized Captive Portal login page:



Authenticating with Captive Portal

Access Guardian determines that a client device is a candidate for Web-based authentication if the following conditions are true:

- The device is connected to a UNP-enabled port.
- The device is assigned to a UNP Edge profile on which Captive Portal authentication is enabled.

When these authentication conditions are met, Access Guardian places the device MAC address into a Captive Portal pre-login state. In this state, the device is allowed to directly contact a DHCP server to get an IP address and get the DNS server address.

Next, the user opens a Web browser and the initial HTTP/HTTPS requests are responded to with the Captive Portal redirect name. The user device contacts the DNS server to resolve the redirect name and receives the configured Captive Portal IP address. Requests are then sent to the Captive Portal IP address that is mapped to the internal OmniSwitch Web server. The internal server responds to the HTTP/HTTPS requests by presenting a Captive Portal login page to the user device.

Logging Into the Network with Captive Portal

Once a user device is in the Captive Portal state, the following steps are required to complete the authentication process:

- 1 Open a Web browser window on the client device. If there is a default home page, the browser attempts to connect to that URL. If a default home page is not available, enter a URL for any website and attempt to connect to that site.

A certificate warning message may appear when the Web browser window opens. If so, select the option to continue on to the website.

When the browser window opens and after the certificate warning message, if any, is cleared, Captive Portal displays a login screen similar to the one shown in the following example :



[WELCOME]

[INSTRUCTIONS]

User ID

Password

I have read and accepted the [Acceptable Use Policy](#).

Note: The "Submit" button will be enabled once the Policy is accepted.

- 2 Enter the user name in the "User ID" field.
- 3 Enter the user password in the "Password" field.

- 4 Click on the “Acceptable Use Policy” box to activate the “Submit” button.
- 5 Click the “Submit” button to login to the network. When the “Submit” button is clicked, Captive Portal sends the user information provided in the login window to the RADIUS server for authentication.
- 6 If user authentication is successful, the following status and logout messages are displayed:



[WELCOME]

You are currently **logged-in** and can use the network for approximately **03:19:57**.

Please bookmark this page (<https://captive-portal1.aluclearpass.com/>) to view your remaining time or to log out.

[Log out](#)

The user is now logged into the network and has access to all network resources as determined by the Captive Portal role (QoS policy list) assigned to the user. The original Edge profile and associated VLAN membership for the user was not changed; only the QoS policy list returned from the RADIUS server is applied to the user.

- 7 Before leaving the Captive Portal status page (shown in Step 6) or closing the browser window, note the URL presented on the status page.

Logging Off the Network with Captive Portal

Click on the “Log out” button on the Captive Portal login status page. If this page is not displayed, go to the bookmarked URL provided in Step 6 of the login procedure on [page 31-54](#). When the URL is entered in the location bar of the browser or the URL bookmark is selected, the Captive Portal login status page is displayed.

When the “Log out” button is selected, the user is logged off the network and the user device returns to a Captive Portal pre-login state. The user is then presented with the Captive Portal login page.

Note. A user is automatically logged out of the network if the Captive Portal session time limit is reached. For more information, see [“Configuring Authentication Session Parameters” on page 31-25](#).

Using Quarantine Manager and Remediation

A client MAC address is determined to be in a quarantined state when one of the following occurs:

- The OmniVista Quarantine Manager (OVQM) application receives a TRAP indicating that the MAC address has to be quarantined. The TRAP may come from a network anomaly detection application or from an IDS running in the same subnet as the client.
- A list containing the quarantined MAC address is manually configured on OVQM.
- A list containing the quarantined MAC address is manually configured on every switch in the network.

After the list of quarantined MAC addresses is known, OVQM can add these addresses to the Quarantine MAC group and push the configuration to the switches in a logical group or to all switches.

The Access Guardian Quarantine Manager and Remediation (QMR) feature moves the users associated with the quarantined MAC addresses to a QMR restricted role. A built-in policy list is associated with the QMR role that restricts quarantined users to communicating with a designated remediation server until their quarantined status is corrected.

The following QMR components are configured through Access Guardian CLI commands:

- **Quarantined MAC address group.** The Access Guardian configures the name of the Quarantine MAC group on the OmniSwitch. This MAC address group contains the MAC addresses of users that are quarantined and are candidates for remediation.

The default name of the MAC group is "Quarantined", but the name can be changed using the **qos quarantine mac-group** command. For example:

```
-> qos quarantine mac-group badMacs
```

- **Remediation server and exception subnets.** When a client is quarantined, all the traffic from the client is blocked by default. However, the administrator can configure access to some exception subnets to which the quarantined client can be redirected, such as the IP address of a remediation server to obtain updates and correct its quarantined state.

The **qmr quarantine allowed-name** command is used to designate IP addresses that a quarantined client can access. For example:

```
-> qmr quarantine allowed-name it-helpdesk 10.1.1.0 ip-mask 255.255.255.0
```

Configuring a maximum of three IP subnets is allowed. Make sure the IP address for the remediation server is included in the allowed list of subnets.

- **Remediation server URL.** The Access Guardian **qmr quarantine path** command is used to specify a URL to which users are redirected for remediation. For example:

```
-> qmr quarantine path www.qmr.alcatel-lucent.com
```

- **Quarantined Page.** When a client is quarantined and a remediation server URL is not configured, QMR can send a Quarantine Page to notify the client of its quarantined state. To enable or disable the sending of a Quarantine Page, use the **qmr quarantine page** command. For example:

```
-> qmr quarantine page enable
```

- **QMR custom proxy port.** This specifies the HTTP proxy port number to which quarantined client traffic is redirected for remediation. The default HTTP port used is TCP 80 and TCP 8080.

The **qmr quarantine custom-proxy** command is used to configure a different proxy port number to use. For example:

```
-> qmr quarantine custom-proxy 8888
```

QMR works on UNP and non-UNP ports. On non-UNP ports, L2 source learning receives the quarantined MAC addresses from QMR and changes the MAC status to 'quarantined'. However, on UNP ports, L2 source learning will not show the quarantined MAC addresses as 'quarantined'. In this case, the appropriate status of the MAC address is displayed through UNP commands.

Use the **show qmr** command to verify the QMR configuration on the switch and use the **show quarantine mac group** command to display a list of the quarantined MAC addresses known to the switch.

For an example of configuring a custom QMR role (policy list) to apply to quarantined users, see the [“Application Example 6: Restricted Role \(Policy List\) Assignment”](#) on page 31-69.

Access Guardian Application Examples

This section provides some typical application examples in which Access Guardian is used to implement network access control in a sample network configuration. The following diagram depicts an Access Guardian network implementation that applies to all of the application examples in this section.

For application examples of the OmniSwitch Bring Your Own Devices (BYOD) solution provided through Access Guardian with ClearPass Policy Manager (CPPM), see the [“BYOD Application Examples”](#) on page 31-95.

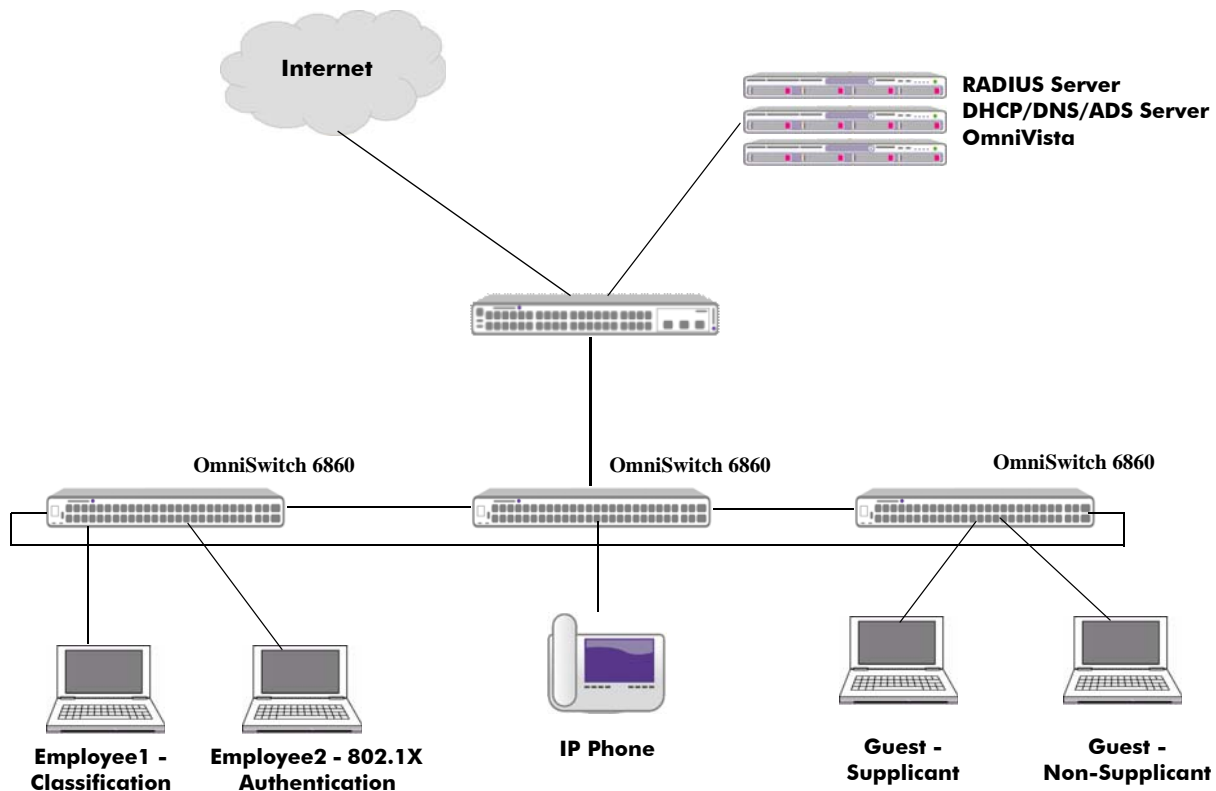

Access Guardian Network Configuration Example

The following application examples are provided in this section:

- [“Application Example 1: Classification \(Port Mobility\)”](#) on page 31-59
- [“Application Example 2: 802.1X Authentication”](#) on page 31-60
- [“Application Example 3: Internal Captive Portal Authentication”](#) on page 31-62
- [“Application Example 4: Supplicant/Non-supplicant with Captive Portal Authentication”](#) on page 31-64
- [“Application Example 5: IP Phone \(LLDP Network Policy TLV/Mobile Tag\)”](#) on page 31-67
- [“Application Example 6: Restricted Role \(Policy List\) Assignment”](#) on page 31-69

Application Example 1: Classification (Port Mobility)

In this configuration example, network access control for Employee1 is provided through the Access Guardian classification mechanism; no authentication is necessary. Classification is a function of the UNP feature and is enabled or disabled on UNP ports. Once enabled, the port and devices connected to the port are eligible for dynamic assignment to a VLAN associated with a UNP Edge profile.

To determine which Edge profile a device is assigned to, the administrator configures UNP classification rules and assigns those rules to the appropriate profile. When traffic on a UNP port with classification enabled matches the criteria of a specific classification rule, the user device is moved into the profile associated with the rule and assigned to the VLAN associated with the profile.

This application example uses a MAC address range classification rule to dynamically assign Employee1 into VLAN 20. The following steps provide a brief tutorial for how to configure this example:

1 Create the required VLANs.

```
-> vlan 10 admin-state disable name vlan10-block
-> vlan 20 admin-state enable name vlan20-corporate
```

2 Create the required UNP Edge profile and map the profile to VLAN 20.

```
-> unp edge-profile corporate
-> unp vlan-mapping edge-profile corporate vlan 20
```

3 Create another UNP Edge profile that will serve as a default profile; map the profile to VLAN 10.

```
-> unp edge-profile default-profile
-> unp vlan-mapping edge-profile default-profile vlan 10
```

4 Create a MAC range classification rule and associate the rule to the “corporate” UNP edge-profile.

```
-> unp classification-rule rule1 mac-address-range 08-00-27-00-98-0A 08-00-27-00-98-FF edge-profile corporate
```

5 Enable UNP on ports that will connect to user devices.

```
-> unp port 1/1/1
```

6 Set the default Edge profile on the port.

```
-> unp port 1/1/1 default-edge-profile default-profile
```

7 Enable classification on the UNP port.

```
-> unp port 1/1/1 classification enable
```

How it Works

In this example, traffic received on the UNP port triggers the following classification process:

- Device traffic is examined and matched against all UNP classification rules.
- If the MAC address of a user device is within the range of MAC addresses specified in a MAC address range rule, the user is classified into the “corporate” profile and assigned to VLAN 20.
- If the MAC address of a user is not within the MAC address range and does not match any other UNP classification rules on the switch, then the user is classified into the default edge-profile and assigned to VLAN 10.

- The MAC addresses are learned in the assigned VLANs and the device port is now an untagged member of the assigned VLANs.

Edge Port Template Example

In Application Example 1 (Classification), individual CLI commands are used in Steps 6 and 7 to configure UNP port parameters. However, it is possible to create an Edge port template that defines port configuration parameters and assigns these parameters to a template name.

- 1 Create an Edge port template.

```
-> unp edge-template classify-template
```

- 2 Configure the template to enable classification on the associated UNP port.

```
-> unp edge-template classify-template classification enable
```

- 3 Configure the template to assign a default UNP Edge profile to the UNP port.

```
-> unp edge-template classify-template default-edge-profile default-profile
```

- 4 Assign the template to the UNP Edge ports to apply the template configuration.

```
-> unp port 1/1/1 edge-template classify-template
```

Using an Edge port template to configure UNP ports helps to simplify and expedite the configuration process. Templates allow the administrator to easily replicate a specific configuration across multiple UNP ports.

Application Example 2: 802.1X Authentication

In this example, network access control for Employee2 is provided through the Access Guardian 802.1X authentication mechanism. Authentication is a function of the UNP feature and is enabled or disabled on UNP ports. There are two types of authentication performed at the port (Layer 2) level: 802.1X and MAC authentication.

This application example demonstrates the 802.1X authentication capability for a supplicant device. The following steps provide a brief tutorial for how to configure this example:

- 1 Configure a server as a RADIUS server on the switch.

```
-> aaa radius-server alu-authserver host 10.242.254.101 hash-key secret  
retransmit 3 timeout 2 auth-port 1812 acct-port 1813
```

- 2 Configure the switch to use “alu-authserver” (identified in Step 1) for 802.1X device authentication.

```
-> aaa device-authentication 802.1x alu-authserver
```

- 3 Configure the switch to use “alu-authserver” for RADIUS server accounting.

```
-> aaa accounting 802.1x alu-authserver
```

- 4 Create the required VLANs.

```
-> vlan 10 admin-state disable name vlan10-block  
-> vlan 20 admin-state enable name vlan20-corporate
```

5 Create the required UNP Edge profile and map the profile to VLAN 20.

```
-> unp edge-profile corporate
-> unp vlan-mapping edge-profile corporate vlan 20
```

6 Create another UNP Edge profile that will serve as a default profile; map the profile to VLAN 10.

```
-> unp edge-profile default-profile
-> unp vlan-mapping edge-profile default-profile vlan 10
```

7 Create an edge template to apply UNP port configuration parameters.

```
-> unp edge-template 802.1X-template
```

8 Configure the template to enable 802.1x authentication and define an alternate UNP profile to use if the RADIUS server does not return a UNP Edge profile name upon successful authentication.

```
-> unp edge-template 802.1x-template 802.1x-authentication enable
-> unp edge-template 802.1x-template 802.1x-authentication pass-alternate edge-profile corporate
```

9 Assign the Edge template to a port.

```
-> unp port 2/1/1 edge-template 802.1x-template
```

How it Works

In this example, traffic received on the UNP port will trigger the following device authentication process on the switch:

- Supplicant device traffic will trigger 802.1 x authentications first.
- If 802.1x authentication passes, the client is classified into to the “corporate” UNP Edge profile and assigned to VLAN 20 or classified into the UNP profile returned from RADIUS server.
- If 802.1x authentication fails and classification is not enabled and a default Edge profile is not assigned, the MAC address of the user device is filtered (blocked).
- In this example, MAC authentication and classification are not enabled on the UNP port, so neither MAC authentication or classification will be triggered for a non-supplicant device. However, a default UNP Edge profile is configured for the port, so a non-supplicant device will get classified into that profile.

AAA Profile Example

In Application Example 2 (802.1X Authentication), individual CLI commands are used in Steps 1–3 to configure AAA parameters. However, it is possible to create an AAA profile that defines the AAA server configuration parameters and assigns these parameters to a profile name. The profile is then assigned to a UNP port or a UNP edge port template.

1 Configure the AAA profile name.

```
-> aaa profile ag-aaa-profile
```

2 Configure the profile to specify the “alu-authserver” for 802.1X device authentication.

```
-> aaa profile ag-aaa-profile device-authentication 802.1x “alu-authserver”
```

- 3 Configure the profile to specify the “alu-authserver” for RADIUS server accounting.

```
-> aaa profile ag-aaa-profile accounting 802.1x alu-authserver
```

- 4 Assign the AAA profile to a UNP port or to a UNP edge port template.

```
-> unp port 2/1/1 aaa-profile ag-aaa-profile
```

```
-> unp edge-template 802.1x-template aaa-profile ag-aaa-profile
```

Application Example 3: Internal Captive Portal Authentication

In this example, network access control is provided for different types of users through Access Guardian internal Captive Portal authentication. For example, university students, teachers, and visitors authenticating through Captive Portal to receive different QoS policy lists based on their role in the network.

Internal Captive Portal authentication is initiated only through a UNP Edge profile. As a result, the user must initially be classified into an Edge profile through Layer 2 authentication (802.1x or MAC), rule classification, or assigned to a default UNP Edge profile.

The Edge profile assigned must have Captive Portal authentication enabled. The Captive Portal authentication process is used to assign a network access role (QoS policy list) to the user. Different policy lists may be assigned to different users.

This application example demonstrates the internal Captive Portal authentication capability to dynamically assign a network access role for a user device. The following steps provide a brief tutorial for how to configure this example.

Network Configuration for Captive Portal Support

- 1 Configure the DHCP server in the network to give out the IP addresses in the subnet of the VLAN associated with the Edge profile that will be used for Captive Portal authentication.
- 2 Configure the DNS with a DNS entry to map the Captive Portal name to the Captive Portal IP address that is configured on the switches in the network.

OmniSwitch Configuration for Captive Portal Support

- 1 Configure a RADIUS server.

```
-> aaa radius-server alu-authserver host 10.242.254.101 hash-key secret  
retransmit 3 timeout 2 auth-port 1812 acct-port 1813
```

- 2 Create an AAA profile to pre-define and apply a specific AAA configuration for this example.

```
-> aaa profile ag-aaa-profile  
-> aaa profile ag-aaa-profile device-authentication captive-portal alu-auth-  
server  
-> aaa profile ag-aaa-profile accounting captive-portal alu-authserver
```

- 3 Create the required VLANs.

```
-> vlan 10 admin-state disable name vlan-block  
-> vlan 30 admin-state enable name vlan-guest
```

4 Create the QoS policy list to apply to the user upon successful Captive Portal authentication.

```
-> policy condition cp-default-C1 source ip Any destination ip Any
-> policy action cp-default-A1
-> policy rule cp-default-R1 condition cp-default-C1 action cp-default-A1
-> policy list cp-default-list type unp
-> policy list cp-default-list rules cp-default-R1
-> qos apply
```

5 Create an Edge profile named “guest”.

```
-> unp edge-profile guest
```

6 Map the Edge profile to an appropriate VLAN.

```
-> unp vlan-mapping edge-profile guest vlan 30
```

7 Create another Edge profile to use as a default profile for a UNP port.

```
-> unp edge-profile default-profile
```

8 Map the Edge profile to VLAN 10.

```
-> unp vlan-mapping edge-profile default-profile vlan 10
```

9 Create an Edge port template to pre-define and apply configuration parameters to the UNP port.

```
-> unp edge-template cp-only-template
```

10 Set the default Edge profile parameter for the Edge port template to “guest”.

```
-> unp edge-template cp-only-template default-edge-profile guest
```

Setting the default Edge profile to “guest” will move the clients into VLAN 30 first. Then a policy list received through Captive Portal authentication is applied to the user (overriding the policy list, if any, that was previous applied through the “guest” profile.

11 Assign the Edge port template to a UNP port.

```
-> unp port 1/1/2 edge-template cp-only-template
```

12 Create a Captive Portal profile to pre-define and apply Captive Portal configuration parameters.

```
-> captive-portal-profile cp-profile
-> captive-portal-profile cp-profile aaa-profile ag-aaa-profile
```

13 Set the Captive Portal profile parameters for the authentication pass policy list and the success URL. The Captive Portal IP address is set to 10.123.0.1 by default.

```
-> captive-portal-profile cp-profile authentication-pass policy-list cp-default
-list
-> captive-portal-profile cp-profile success-redirect-url http://test-cp.com/
success.html
```

The authentication pass parameter specifies the policy list to apply to the device if Captive Portal authentication is successful but the RADIUS server does not return a policy list. The success URL specifies where to redirect the user device after a successful Captive Portal authentication attempt.

14 Enable Captive Portal for the Edge profile and assign the Captive Portal profile to the same Edge profile.

```
-> unp edge-profile guest captive-portal-authentication enable
-> unp edge-profile guest captive-portal-profile cp-profile
```

How it Works

In this example, traffic arriving on the UNP port triggers the following process on the switch:

- The UNP port is not enabled with authentication or classification, so the client is assigned to the default UNP Edge profile and associated VLAN.
- Since the default UNP Edge profile (associated with Edge template assigned to the port) is enabled for Captive Portal authentication, the Captive Portal authentication process is triggered.
- The client is placed into a built-in Captive Portal pre-login role which does the following:
 - Only allows client access for DHCP, DNS, ARP, and ICMP traffic.
 - Traps and redirects client HTTP/HTTPS traffic to the internal Captive Portal Web server on the switch. The Captive Portal server name and IP address was resolved by the client through DNS.
 - Client is presented with an internal Captive Portal login page.
 - Client enters user credentials which are then authenticated through the RADIUS server designated for Captive Portal authentication.
- Successful Captive Portal authentication results in the assignment of a policy list that was returned from the RADIUS server or specified through the Captive Portal authentication pass configuration.
- The client remains in the “guest” Edge profile assigned to VLAN 30 and is presented with a Captive Portal login status page.
- If Captive Portal authentication fails, the client remains in the built-in Captive Portal pre-login role.

Application Example 4: Supplicant/Non-supplicant with Captive Portal Authentication

In this example, network access control is provided for corporate devices and guest devices trying to access the network on the same port. The scenarios covered in this example are as follows:

- Corporate supplicant device.
 - Passes 802.1X authentication.
 - Is assigned a UNP corporate Edge profile with an associated VLAN.
- Corporate user with non-supplicant, non-corporate device.
 - Does not trigger 802.1X authentication.
 - Fails MAC authentication.
 - When MAC authentication fails and classification is not enabled, a default Edge profile associated with the UNP port will be assigned. Captive Portal authentication is enabled for the default Edge profile.
 - The Captive Portal authentication pass condition may apply a new access policy list or the access policy list associated with the default Edge profile is applied.
- Guest supplicant device.

- Fails 802.1x authentication.
- If an 802.1x failure policy is not set and classification is not enabled, a default Edge profile associated with the UNP port will be assigned. Captive Portal authentication is enabled for the default Edge profile.
- The Captive Portal authentication pass condition may apply a new access policy list or the access policy list associated with the default Edge profile is applied.
- Guest non-suppliant device.
 - Fails 802.1x authentication.
 - MAC authentication is not automatically triggered, unless explicitly enabled on the UNP port.
 - If MAC authentication fails and classification is not enabled, a default Edge profile associated with the UNP port will be assigned. Captive Portal authentication is enabled for the default Edge profile.
 - The Captive Portal authentication pass condition may apply a new access policy list or the access policy list associated with the default Edge profile is applied.

The following steps provide a brief tutorial for how to configure this application example:

1 Configure a RADIUS server.

```
-> aaa radius-server alu-authserver host 10.242.254.101 hash-key secret
retransmit 3 timeout 2 auth-port 1812 acct-port 1813
```

2 Create an AAA profile to pre-define and apply a specific AAA configuration for this example.

```
-> aaa profile ag-aaa-profile device-authentication 802.1x alu-authserver
-> aaa profile ag-aaa-profile accounting 802.1x alu-authserver
-> aaa profile ag-aaa-profile device-authentication mac alu-authserver
-> aaa profile ag-aaa-profile accounting mac alu-authserver
-> aaa profile ag-aaa-profile device-authentication captive-portal alu-
authserver
-> aaa profile ag-aaa-profile accounting captive-portal alu-authserver
```

3 Create the required VLANs.

```
-> vlan 10 admin-state disable name vlan-block
-> vlan 20 admin-state enable name vlan-corporate
-> vlan 30 admin-state enable name vlan-guest
```

4 Create the required UNP Edge profiles.

```
-> unp edge-profile corporate
-> unp edge-profile guest
```

5 Map the Edge profiles to the appropriate VLANs.

```
-> unp vlan-mapping edge-profile corporate vlan 20
-> unp vlan-mapping edge-profile guest vlan 30
```

6 Create a default Edge profile.

```
-> unp edge-profile default-profile
```

7 Map the default Edge profile to VLAN 10.

```
-> unp vlan-mapping edge-profile default-profile vlan 10
```

- 8** Create an Edge port template to pre-define and apply configuration parameters to the UNP port.

```
-> unip edge-template auth-template
```

- 9** Set the default Edge profile parameter for the Edge port template to “guest”.

```
-> unip edge-template auth-template default-edge-profile guest
```

- 10** Set the MAC and 802.1X authentication parameters to “enable” for the Edge port template. Can also define a pass alternate UNP Edge profile for the template if the RADIUS server does not return a UNP Edge profile name when 802.1X or MAC authentication passes.

```
-> unip edge-template auth-template mac-authentication enable
-> unip edge-template auth-template 802.1x-authentication enable
-> unip edge-template auth-template mac-authentication pass-alternate edge-
profile corporate
-> unip edge-template auth-template 802.1x-authentication pass-alternate edge-
profile corporate
```

- 11** Assign the Edge port template to a UNP port.

```
-> unip port 2/1/1 edge-template auth-template
```

- 12** Create a Captive Portal profile.

```
-> captive-portal-profile cp-profile
-> captive-portal-profile cp-profile aaa-profile ag-aaa-profile
```

- 13** Add a Captive Portal authentication pass policy list to the profile.

```
-> captive-portal-profile cp-profile authentication-pass policy-list cp-default-
list
```

- 14** Create a UNP Edge profile with Captive Portal enabled and assign the Captive Portal profile to the Edge profile.

```
-> unip edge-profile guest captive-portal-authentication enable
-> unip edge-profile guest captive-portal-profile cp-profile
```

How it Works

In this application example, traffic received on the UNP port triggers the following actions on the switch:

- Traffic from a supplicant device triggers the 802.1X authentication process.
- If 802.1X authentication passes, the client is classified into the “corporate” Edge profile or classified into the Edge profile returned from the RADIUS server.
- If 802.1X authentication fails, the client is classified into the default Edge profile associated with the UNP port. This is because rule classification is disabled on the port. Captive Portal authentication is enabled for the default Edge profile.
- Traffic from a non-suppliant device triggers the MAC authentication process.
- If MAC authentication passes, the client is classified into the “corporate” Edge profile or classified into the Edge profile returned from the RADIUS server.
- If MAC authentication fails, the client is classified into the default Edge profile associated with the UNP port. This is because rule classification is disabled on the port. Captive Portal authentication is enabled for the default Edge profile.

- The Captive Portal authentication pass condition applies a new access policy list to the client.
- If Captive Portal authentication fails, the client remains in a built-in Captive Portal pre-login state.

Application Example 5: IP Phone (LLDP Network Policy TLV/ Mobile Tag)

In this example, network access control is provided for the following IP phone devices:

- An IP phone enabled for LLDP Network Policy TLV and connected to a switch that is configured to send a Network Policy TLV with tagged VLAN.
- An IP phone that is statically configured to tag traffic with a specific VLAN.

The VLAN associated with the UNP Edge profile the IP phone is assigned to must be tagged on the port after authentication. The following configuration steps provide a brief tutorial for how to achieve this:

1 Configure a RADIUS server.

```
-> aaa radius-server alu-authserver host 10.242.254.101 hash-key secret
retransmit 3 timeout 2 auth-port 1812 acct-port 1813
```

2 Create an AAA profile to pre-define and apply a specific AAA configuration for this example.

```
-> aaa profile ag-aaa-profile device-authentication 802.1x alu-authserver
-> aaa profile ag-aaa-profile accounting 802.1x alu-authserver
-> aaa profile ag-aaa-profile device-authentication mac alu-authserver
-> aaa profile ag-aaa-profile accounting mac alu-authserver
-> aaa profile ag-aaa-profile device-authentication captive-portal alu-
authserver
-> aaa profile ag-aaa-profile accounting captive-portal alu-authserver
```

3 Create the required VLANs.

```
-> vlan 10 admin-state disable name vlan-block
-> vlan 20 admin-state enable name vlan-corporate
-> vlan 30 admin-state enable name vlan-guest
-> vlan 40 admin-state enable name vlan-voice
```

4 Create the required UNP Edge profiles.

```
-> unp edge-profile corporate
-> unp edge-profile guest
-> unp edge-profile corporate-voice
```

5 Map the each Edge profile to an appropriate VLAN.

```
-> unp vlan-mapping edge-profile corporate vlan 20
-> unp vlan-mapping edge-profile guest vlan 30
-> unp vlan-mapping edge-profile corporate-voice vlan 40
```

6 Enable mobile tagging on the Edge profile.

```
-> unp edge-profile corporate-voice mobile-tag enable
```

7 Create a default UNP Edge profile to assign to the UNP port.

```
-> unp edge-profile default-profile
```

8 Map the default UNP Edge profile to VLAN 10

```
-> unp vlan-mapping edge-profile default-profile vlan 10
```

9 Create UNP Edge port template to pre-define and apply configuration parameters to the UNP port.

```
-> unp edge-template voice-template
```

10 Set the default Edge profile parameter for the Edge port template to “default-profile”.

```
-> unp edge-template voice-template default-edge-profile default-profile
```

11 Set the MAC and 802.1X authentication parameters to “enable” for the Edge port template. Can also define a pass alternate UNP Edge profile for the template if the RADIUS server does not return a UNP Edge profile name when 802.1X or MAC authentication passes.

```
-> unp edge-template voice-template mac-authentication enable
-> unp edge-template voice-template 802.1x-authentication enable
-> unp edge-template voice-template mac-authentication pass-alternate edge-
profile corporate
-> unp edge-template voice-template 802.1x-authentication pass-alternate edge-
profile corporate
```

12 Assign the Edge port template to a UNP port.

```
-> unp port 3/1/1-2 edge-template voice-template
```

13 Enable LLDP IP Phone classification.

```
-> unp classification lldp med-endpoint ip-phone edge-profile corporate-voice
```

14 Configure LLDP on the port.

```
-> lldp port 3/1/1-2 lldpdu tx-and-RX
-> lldp network-policy 1 application voice vlan 40 l2-priority 6
-> lldp port 3/1/1-2 med network-policy 1
```

How it Works

The expected traffic flow for this application example is as follows:

- EAP frames are the first frames sent by the IP phone on link up. The EAP frames are untagged.
- If IP phone is a supplicant, 802.1X authentication is initiated. If the phone is a non-supplicant, MAC authentication is initiated.
- If the RADIUS server is configured to return the correct UNP Edge profile for the voice device, then that profile is applied when the device passes authentication.
- If the RADIUS server is not configured to return the UNP Edge profile, then the 802.1X or MAC authentication pass alternate Edge profile is applied. Mobile tagging is enabled for the authentication pass alternate Edge profile.
- If 802.1X authentication fails, device is blocked. If MAC authentication fails, device must be enabled for LLDP IP phone classification.
- The VLAN assigned after authentication and classification pass should be the same VLAN referred to in the configuration steps for this application example—the VLAN in the LLDP Network TLV advertisement and the VLAN associated with the UNP Edge profile assigned to the IP phone. This VLAN should also be tagged on the UNP port, so that the traffic to or from the IP phone can be tagged.

- LLDP frames are exchanged between phone and the switch. This will be untagged traffic but will be accepted by the switch since these are control frames.
- Subsequent data traffic will be tagged with the right VLAN after the LLDP exchange; this traffic will be accepted because the VLAN is a tagged member of the port.

Application Example 6: Restricted Role (Policy List) Assignment

This application example demonstrates post-authentication role assignment through the QMR feature, a location-based policy, and a time-based policy.

Quarantine Manager and Remediation (QMR)

A client MAC address is determined to be in a quarantined state when one of the following occurs:

- The OmniVista Quarantine Manager (OVQM) application receives a TRAP indicating that the MAC address has to be quarantined. The TRAP may come from a network anomaly detection application or from an IDS running in the same subnet as the client.
- A list containing the quarantined MAC address is manually configured on OVQM.
- A list containing the quarantined MAC is manually configured on every switch in the network.

After the list of quarantined MAC addresses is known, OVQM can add these addresses to the Quarantine MAC group and push the configuration to the switches in a logical group or to all switches. Access Guardian then moves the users associated with the quarantined MAC addresses to a QMR restricted role.

There is a built-in policy list associated with the QMR restricted role that can be replaced with a user-defined policy list. For example, the administrator may want to use the following explicit policy list for QMR redirection instead of the built-in policy list:

```
-> policy service http80 destination tcp-port 80
-> policy service http443 destination tcp-port 443
-> policy service http8080 destination tcp-port 8080
-> policy service http8081 destination tcp-port 8081
-> policy service group alaRestrictedHttpSG http80 http443 http8080 http8081
-> policy condition qmr_traffic service group alaRestrictedHttpSG
-> policy action qmr_action redirect module qmr
-> policy rule qmr_rule condition qmr_traffic action qmr_action no default-list
-> policy list qmr_list type unp
-> policy list qmr_list rules qmr_rule
-> qos apply
```

With minor changes (such as changing the redirect module option to “captive-portal” or “byod”), this example policy list may also be useful for internal Captive Portal and OmniSwitch BYOD redirection.

The following OmniSwitch configuration demonstrates assigning a different role (explicit policy list) to a quarantine user as well as an example of configuring QMR on the switch:

1 Use the **unp restricted-role policy-list** command to assign a new policy list to replace the built-in QMR policy list. This is an optional command.

```
-> unp restricted-role qmr policy-list qmr_list
```

2 Configure the name of the Quarantine MAC Group. The default name of this group is “Quarantined”, so changing the name is optional. To change the name of this group, use the **qos quarantine mac-group** command.

```
-> qos quarantine mac-group bad-macs
```

Make sure the name of this group on the OmniSwitch matches the group name used by OVQM

3 The Quarantine MAC address group is populated from the same group located on an LDAP server. However, it is also possible to manually add MAC addresses to the MAC address group on the switch.

```
-> policy mac group Quarantined 00:9a:2d:00:00:10
```

4 Apply the QoS configuration for the MAC group name change (Step 2) and the manual MAC address changes (Step 3) to take effect on the switch.

```
-> qos apply
```

5 Add the IP address and subnet of the remediation server to a list of allowed IP addresses using the **qmr quarantine allowed-name** command. The allowed IP list specifies IP network addresses that a device is allowed to communicate with while in a quarantined state.

```
-> qmr quarantine allowed-name it-helpdesk 10.1.1.0 ip-mask 255.255.255.0
```

6 Create the path to the remediation server using the **qmr quarantine path** command.

```
-> qmr quarantine path www.remediate.com
```

7 If there is no quarantine path to redirect to, use the **qmr quarantine page** command to direct the switch to send a quarantine page to inform the user of the quarantined state.

```
-> qmr quarantine page enable
```

For more information about the QMR feature, see [“Using Quarantine Manager and Remediation” on page 31-56](#).

UNP Edge Profile - Time Policy

A time-based policy is associated with a UNP Edge profile to define a validity period during which the profile applies a role (policy list) to the user. When a user classified into the Edge profile violates the validity period, the user is moved into an Unauthorized role.

There is a built-in policy-list associated with the Unauthorized role that can be replaced with a user-defined policy list. The following OmniSwitch configuration demonstrates assigning a different role to a user in an Unauthorized state as well as an example of configuring time based policies:

1 Create different validity periods as required. Different validity periods can be defined and assigned to different UNP Edge profiles.

```
-> unp policy validity-period employee-shift-time days monday tuesday wednesday  
thursday friday timezone PST hours 6:00 TO 18:00
```

```
-> unp policy validity-period guest-time days Monday tuesday wednesday thursday  
friday saturday sunday timezone PST hours 9:00 TO 18:00
```

2 Assign the time policies created in Step 1 to an existing UNP Edge profile.

```
-> unp edge-profile UNP-employee period-policy employee-shift-time  
-> unp edge-profile UNP-guest period-policy guest-time
```

3 Assign a new policy list to replace the built-in policy list for the Unauthorized role.

```
-> unp restricted-role unauthorized policy-list unauthorized-time
```

UNP Edge Profile - Location Policy

A location-based policy is associated with a UNP Edge profile to define a specific location from which a device can access the network. When a user classified into the Edge profile violates the location policy, the user is moved into an Unauthorized role.

There is a built-in policy-list associated with the Unauthorized role that can be replaced with a user-defined policy list. The following OmniSwitch configuration demonstrates assigning a different role to a user in an Unauthorized state as well as an example of configuring time based policies:

1 Create different location policies as required. Different location policies can be defined and assigned to different UNP Edge profiles.

```
-> unp policy validity-location employee-location port 1/1/1-24
-> unp policy validity-location guest-location port 1/1/15-24
```

2 Assign the location policies created in Step 1 to an existing UNP Edge profile.

```
-> unp edge-profile UNP-employee location-policy employee-location
-> unp edge-profile UNP-guest period-policy guest-location
```

3 Assign a new policy list to replace the built-in policy list for the Unauthorized role.

```
-> unp restricted-role unauthorized policy-list unauthorized-location.
```

Verifying Access Guardian Users

The following UNP **show** commands provide a centralized way to verify the status of users authenticated and classified through Access Guardian security mechanisms:

- show unp edge-user**
- show unp edge-user status**
- show unp edge-user details**
- show unp vlan-user details**
- show unp spb-access-user details**
- show unp user**

This section provides sample display outputs from the **show unp edge-user** commands. For more information about the display outputs for the other **show unp** commands, see the “UNP Commands” chapter in the *OmniSwitch AOS Release 8 CLI Reference Guide*.

1 The **show unp edge-user** command displays information about the MAC addresses learned on UNP Edge ports and link aggregates:

```
-> show unp edge-user port 1/1/6
```

Port	Username	Mac address	User		Vlan	Profile	Auth	Role
			IP					
1/1/6	test_user	00:00:00:00:00:06	1.1.1.6	1	1	Block	-	-

```
Total users : 1
```

```
-> show unp edge-user linkagg 100
```

Port	Username	Mac address	User		Vlan	Profile	Auth	Role
			IP					
0/100	Employee-001	00:00:00:00:00:04	1.1.1.4	10	10	Profile6	8021X	Employee

```
Total users : 1
```

```
-> show unp edge-user edge-profile Profile6
```

Port	Username	Mac address	User		Vlan	Profile	Auth	Role
			IP					
0/100	Employee-001	00:00:00:00:00:04	1.1.1.4	10	10	Profile6	8021X	Employee

```
Total users : 1
```

```
-> show unp edge-user authentication-type MAC
```

Port	Username	Mac address	User		Vlan	Profile	Auth	Role
			IP					
1/1/7	00:00:00:00:00:07	00:00:00:00:00:07	1.1.1.7	11	11	Profile4	MAC	Limited
0/120	00:00:00:00:00:14	00:00:00:00:00:14	1.1.2.4	20	20	Profile7	MAC	Employee

```
Total users : 2
```

2 The **show unip edge-user status** command displays the status of the authentication and validation process for MAC addresses learned on a UNP Edge port or link aggregate:

```
-> show unip edge-user status port 1/1/1
      Profile Profile Auth          Role Restricted
Port  Mac address  Name   Source  Type   Status  Name Role Source CP Redirect Access
-----+-----+-----+-----+-----+-----+-----+-----+-----+-----+-----+-----
1/1/1 00:00:00:00:00:05 Prf1    Radius  8021x  Passed  emp1 Profile  Y - -

Total users : 1

-> show unip edge-user status linkagg 100
      Profile Profile Auth          Role Restricted
Port  Mac address  Name   Source  Type   Status  Name Role Source CP Redirect Access
-----+-----+-----+-----+-----+-----+-----+-----+-----+-----+-----+-----
0/100 00:00:00:00:00:06 Prf3    Radius  8021x  Passed  emp1 Profile  Y - -

Total users : 1

-> show unip edge-user status authentication type MAC
      Profile Profile Authentication Role Restricted
Port  Mac address  Name   Source  Type   Status  Name Role Source CP Redirect Access
-----+-----+-----+-----+-----+-----+-----+-----+-----+-----+-----+-----
1/1/2 00:00:00:00:00:15 Prf2    Alt     MAC     Passed  emp2 Profile  Y - -

Total users : 1
```

3 The **show unip edge-user details** command displays additional details about MAC addresses learned on a UNP Edge port or link aggregate:

```
-> show unip edge-user details port 1/1/10
Port: 1/1/10
  MAC-Address: 00:00:00:00:00:01
Access Timestamp      : 04/01/1970 18:45:26,
User Name             : guest1,
IP-address            : 10.0.0.1,
Vlan                  : 10,
Authentication Type   : 802.1X,
Authentication Status : Authenticated,
Authentication Failure Reason : -,
Authentication Retry Count : -,
Authentication Server IP Used = 10.135.62.129,
Authentication Server Used   = rad1,
Server Reply-Message       = -,
Profile                  : Employee,
Profile Source            : RADIUS Server Profile,
Classification profile rule : -,
Role                     : Employee,
Role Source              : Profile,
User role rule           : -,
Restricted Access        : No,
Location Policy Status   : Passed,
Time Policy Status       : Passed,
Captive-Portal Status   : -,
QMR Status              : Passed,
Redirect Url            : -,
SIP Call Type           = Not in a call,
SIP Media Type          = None,
Applications            = None
```

```

MAC-Address: 00:00:00:00:00:02
Access Timestamp      : 06/01/1989 20:45:26,
User Name            : guest2,
IP-address           : 20.0.0.1,
Vlan                  : 20,
Authentication Type   : MAC,
Authentication Status : Authenticated,
Authentication Failure Reason : -,
Authentication Retry Count : -,
Authentication Server IP Used = 10.135.62.129,
Authentication Server Used   = rad1,
Server Reply-Message        = -,
Profile                      : Contractor,
Profile Source                : RADIUS Server Profile,
Classification profile rule   : -,
Role                          : Contractor,
Role Source                    : Profile,
User role rule                 : -,
Restricted Access              : No,
Location Policy Status        : Passed,
Time Policy Status             : Passed,
Captive-Portal Status        : Passed,
QMR Status                    : -,
Redirect Url                  : -,
SIP Call Type                 = Normal Call,
SIP Media Type                 = Video,
Applications                   = None
-> show unpag edge-user details linkagg 100
Port: 0/100

```

```

MAC-Address: 00:00:00:00:00:03
Access Timestamp      : 02/01/2013 20:45:26,
User Name            : guest3,
IP-address           : 30.0.0.1,
Vlan                  : 30,
Authentication Type   : MAC,
Authentication Status : Authenticated,
Authentication Failure Reason : -,
Authentication Retry Count : -,
Authentication Server IP Used = 10.135.62.129,
Authentication Server Used   = rad1,
Server Reply-Message        = -,
Profile                      : Employee,
Profile Source                : RADIUS Server Profile,
Classification profile rule   : -,
Role                          : Contractor,
Role Source                    : Profile,
User role rule                 : -,
Restricted Access              : No,
Location Policy Status        : Passed,
Time Policy Status             : Passed,
Captive-Portal Status        : Passed,
QMR Status                    : -,
Redirect Url                  : -,
SIP Call Type                 = Not in a call,
SIP Media Type                 = None,
Applications                   = ;Facebook;rediff;

```

For more information about the displays that result from these commands, see the “UNP Commands” chapter in the *OmniSwitch AOS Release 8 CLI Reference Guide*.

Logging Users Out of the Network

In the event that it becomes necessary to manually log a user out of the network, the **unp edge-user flush** command is available to the switch admin user. The following parameters are available with this command to specify which user MAC addresses are flushed:

- **mac-address**—Flushes the user device with the specified source MAC address. For example:

```
-> unp edge-user flush mac-address 00:2a:95:00:3a:10
```
- **port chassis/slot/port**—Flushes the MAC addresses of all users connected to the specified switch port. For example:

```
-> unp edge-user flush port 1/9
```
- **linkagg agg_id**—Flushes the MAC addresses of all users connected to the specified link aggregate. For example:

```
-> unp edge-user flush linkagg 10
```
- **type {802.1x, mac, none}**—Flushes the MAC addresses of all users authenticated with the specified authentication type or users that have not been authenticated. For example:

```
-> unp edge-user flush type 802.1x  
-> unp edge-user flush type mac  
-> unp edge-user flush type none
```
- **edge-profile profile_name**—Flushes the MAC addresses of all users associated with the specified Edge profile name. Combine this parameter with the **mac-address** parameter to flush a specific user associated with the specified Edge profile name. For example:

```
-> unp edge-user flush edge-profile EP-1  
-> unp edge-user flush edge-profile EP-1 mac-address 00:da:95:11:22:01
```

Logging a group of users out of the network is particularly useful if configuration changes are required to any Access Guardian features. The **unp edge-user flush** command is only available to the switch admin user. The admin account, however, is protected from any attempts to log out the admin user.

Verifying the Access Guardian Configuration

A summary of the **show** commands used for verifying the Access Guardian configuration is given here:

show unnp global configuration	Displays the global UNP parameter settings for the switch
show unnp port	Displays the UNP configuration for a port or link aggregate.
show unnp port 802.1x statistics	Displays 802.1X statistics for a UNP port or link aggregate on which 802.1X authentication is enabled.
show unnp port configured-vlans	Displays the VLANs assigned to UNP edge and bridge ports or link aggregates.
show unnp edge-template	Displays the UNP Edge port template configuration.
show unnp group-id	Displays the UNP Group ID configuration. This type of ID is used to group UNP edge ports into a logical domain.
show unnp customer-domain	Displays the UNP customer domain ID configuration. This type of ID is used to group UNP bridge and SPB access ports into a logical domain.
show unnp edge-profile	Displays the UNP Edge profile configuration.
show unnp edge-profile vlan-mapping	Displays the VLAN ID association for UNP Edge profiles.
show unnp classification	Displays the UNP classification rule configuration for individual and binding rules.
show unnp classification-rule	Displays the UNP extended classification rule configuration.
show unnp user-role	Displays the UNP user-defined role configuration.
show unnp restricted-role	Displays the explicit policy list configuration for built-in restricted roles.
show aaa device-authentication	Displays a list of RADIUS servers assigned to provide 802.1X, MAC, or Captive Portal authentication.
show aaa accounting	Displays a list of RADIUS servers assigned to provide 802.1X, MAC, or Captive Portal accounting.
show aaa config	Displays the AAA parameter configuration for 802.1X, MAC, and Captive Portal sessions
show aaa profile	Displays the AAA profile configuration.
show captive-portal configuration	Displays the global Captive Portal settings for the switch.
show captive-portal profile-name	Displays the Captive Portal configuration for the switch.
show qmr	Displays the global QMR settings for the switch.
show quarantine mac group	Displays the contents of the Quarantined MAC address group.

For more information about the displays that result from these commands, see the *OmniSwitch AOS Release 8 CLI Reference Guide*.

Bring Your Own Devices (BYOD) Overview

The Alcatel-Lucent OmniSwitch implementation of Bring Your Own Devices (BYOD) leverages the ClearPass Policy Manager (CPPM) and Access Guardian features on the OmniSwitch. BYOD can be implemented on a campus, branch offices, Internet edge, and converged access networks. It allows a wired guest, device, or authenticated user to connect to the network through an OmniSwitch edge device using the CPPM for unified authentication.

The BYOD support on the OmniSwitch provides the following:

- Unified access policy management solution for Wireline networks using CPPM.
- Integration with Access Guardian UNPs, 802.1x authentication, and MAC authentication.

Note. See [“UNP Profiles” on page 31-15](#) for additional information about UNPs and authentication methods.

- RADIUS Change of Authorization (CoA):
 - Provides a mechanism to change AAA attributes of a session after authentication.
 - Sends the New Profile as an attribute in the message.
 - Sends a Disconnect Message to terminate user session and discard all user context.
- A validated BYOD solution using CPPM with CoA and the OmniSwitch.
- Restricted access to the network and validation for end user devices, including employees with IT supplied devices, IP phones, employees personal devices, guest devices, access points, cameras, and silent devices (such as printers).
- CPPM can act as a RADIUS server for new deployments or RADIUS proxy for existing networks.
- Captive Portal redirect using a new dynamic redirect URL Vendor Specific Attribute (VSA).

The remainder of this section focuses on OmniSwitch integration with the CPPM. Refer to the following for more information:

- OmniAccess WLAN documentation.
- ClearPass Policy Manager documentation for in-depth server configuration and licensing requirements.

Key Components of a BYOD Solution

The OmniSwitch BYOD solution comprises of the following main components:

- The network infrastructure consisting of both wireless and wireline networks. The OmniSwitch leverages the Access Guardian features, such as 802.1x (supplicant) and MAC (non-supplicant) authentication and classification through the User Network Profile (UNP) framework to support the BYOD solution.
- The CPPM interacts with both wireless and wireline networks acting as a RADIUS server or RADIUS server proxy. The CPPM provides policy management, guest access, onboarding, and posture checking capabilities.

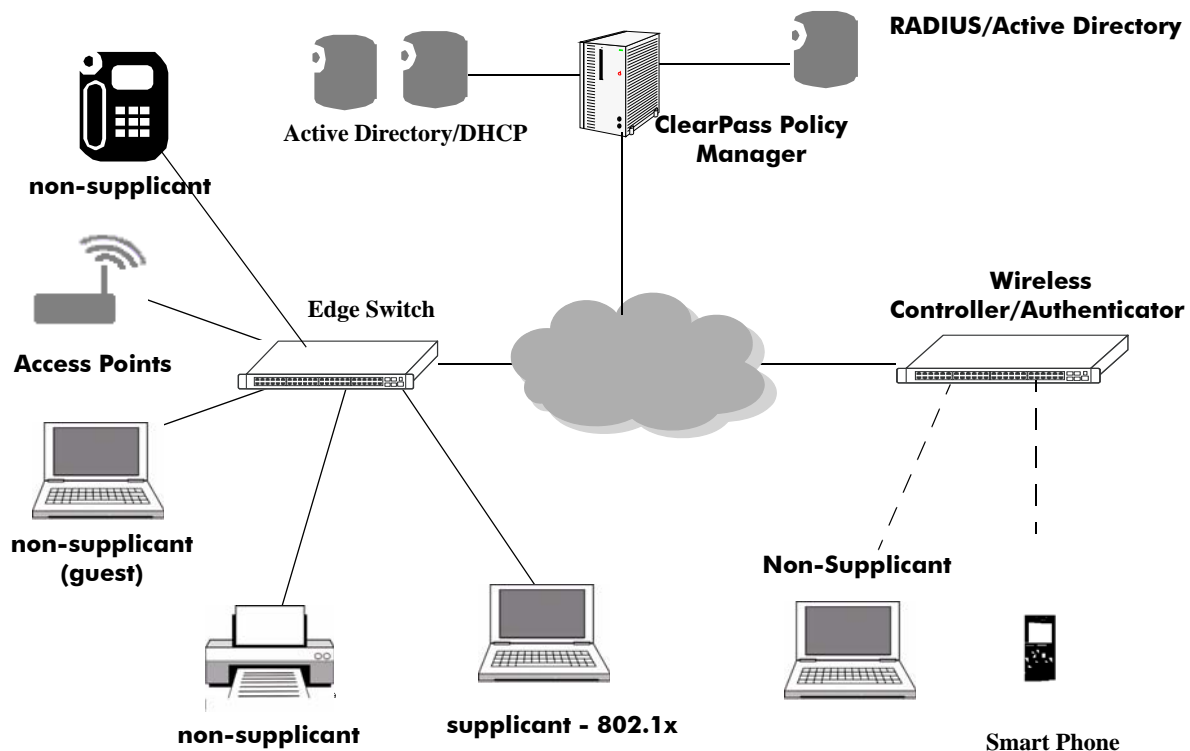

BYOD Network Illustration

ClearPass Policy Manager

ClearPass Policy Manager (CPPM) association and configuration is required for the OmniSwitch BYOD solution. This section describes the various services, features, and settings provided by ClearPass and interaction with OmniSwitch.

ClearPass Guest

The OmniSwitch BYOD solution supports guest self registration, sponsored guest access, and pre-registration of guest devices using MAC and Captive Portal authentication.

- Self Registration
 - An integrated external Captive Portal for guest or visitor registration.
 - Redirection to a customizable guest registration Captive Portal
- Sponsored Access
 - SMS and text email notification

ClearPass Policy Manager

ClearPass provides a user and device-independent framework that supports any BYOD initiative, large or small, by providing:

- Self-service onboarding, provisioning and revocation of access for all major mobile devices.
- Device profiling as a basis for grooming traffic and improving network security based on device category, such as:
 - Device Category - Computer, Printer, AP
 - OS Family - MAC, Android, Windows, Linux
 - Device name and OS version
 - Useful for wired devices such as printers, access points, IP Phones, and cameras
- Controlled access and remediation for compromised devices
- Device disconnect if device signature changes
 - Secure guest network access with simplified workflows.

ClearPass Onboard

The BYOD solution supports the following services for device on-boarding and device management for guest and registered devices:

- Automatic configuration of Wireless, Wired 802.1X, VPN settings of personal and corporate devices that are connecting to the network for the first time.
- Management of digital certificates.
- Device on-boarding system is integrated with the external Captive Portal, which is separate from the internal OmniSwitch Captive Portal.
- Integration with the Enterprise Active Directory for authentication of employee credentials before device credentials are issued.
- Device provisioning supported through Aruba Quick Connect or Apple OTA API.

- Quick Connect supports native supplicants on Windows Vista, XP, 7, Apple, and Android devices.

ClearPass OnGuard

ClearPass OnGuard agents perform advanced endpoint posture checking to ensure compliance is met before the devices connect. OnGuard has the following functionalities:

- Enhanced capabilities for endpoint compliance and control.
- Supports Microsoft, Apple, and Linux operating systems.
- Anti-virus, anti-spyware, firewall checks and more using the persistent or dissolvable agent.
- Optional auto-remediation and quarantine capabilities.
- System-wide endpoint messaging, notifications and session control.
- Centrally view the online status of all devices from the ClearPass Policy Manager platform.

OmniSwitch and ClearPass Integration

Consider the following key points regarding OmniSwitch and ClearPass integration for BYOD support:

- The same UNPs and access lists must be configured on both the OmniSwitch and CPPM for proper alignment.
- The RADIUS server configuration on the OmniSwitch must point to the CPPM in both proxy and server cases.
- A redirection server must be configured on the OmniSwitch that points to the CPPM.
- Support for the Dynamic Vendor Specific Attribute (VSA) URL redirect is implemented using the OmniSwitch VSAs. The VSAs must be downloaded and installed on the ClearPass server.
- A port bounce capability is configurable on the OmniSwitch to ensure a clean re-authentication process for non-supplicant devices.
- A PAUSE timer is configurable to flush out a user context (that is used for a welcome page or other user context information) on timer expiry.

RFC-3576 Attributes

ClearPass RADIUS servers and the OmniSwitch can be configured with particular attributes defined in RFC 3576. These attributes carry specific authentication, authorization, and configuration details about RADIUS requests to and replies from the server. This section describes the attributes specific to an OmniSwitch BYOD solution.

Num.	CoA Attribute	Notes
40	Disconnect-Request	Disconnect Request sent by RADIUS/ClearPass server. <ul style="list-style-type: none"> • The Disconnect-Request RADIUS message contains the User-Name or the Calling-Station-ID attribute. • When the message contains both the User-Name and Calling-Station-ID, the MAC address is identified based on the Calling-Station-ID only.

41 DM-ACK	On reception of Disconnect request message (DM), all device authentication is removed from the switch. Disconnect request message (DM) Acknowledgment for RADIUS/ClearPass authentication
42 DM-NACK	Disconnect request message (DM) Not Acknowledged
43 CoA-Request	CoA message is sent from ClearPass Server. CoA-Request packets contain information for dynamically changing session authorizations. The following attributes are used: <ul style="list-style-type: none"> • The User-Name: AOS retrieves the MAC address associated to this user • The Calling-Station-ID: This explicitly specify the user MAC address When the message contains both the User-Name and Calling-Station-ID , the MAC address is identified based on the Calling-Station-ID only.
44 CoA-ACK	Supports a Change of Authorization-Request (CoA) message for RADIUS authentication. COA-ACK is sent by OmniSwitch to ClearPass that has attributes MD5 hash value and Identifier.
45 CoA-NACK	COA-NACK message is sent from OmniSwitch. For NAK message, the Error-Cause attribute must be supported and filled accordingly.
Error-Cause	Supported as part of CoA-NAK and DM-NAK message. Error-Cause Scenarios: Missing Attribute - If User name and Calling station ID Filter ID not present Invalid Request - If Client context does not exist Unsupported Attribute - Request contains an unsupported Vendor-Specific attribute Unsupported Service - Request contains an unsupported or invalid service in Service-Type attribute Nas Identification Mismatch - Request contains one or more NAS identification attributes that does not match the identity of the NAS receiving the request Administratively Prohibited - NAS prohibiting the Request messages for the specified session Session Context Not Found - Session context identified in the request does not exist on the NAS Resources Unavailable - Request could not be honored due to lack of available NAS resources

Vendor-Specific Attributes for ClearPass

The Alcatel-Lucent RADIUS client supports attribute 26, which includes a vendor ID and some additional sub-attributes called subtypes. The vendor ID and the subtypes collectively are called Vendor Specific Attributes (VSAs).

For ClearPass integration, the VSA dictionary must be updated with the "**Alcatel-Redirect-URL**" and the "**Alcatel-Access-Policy-List**" VSA that can be imported into the ClearPass server. The following VSAs can be imported to the ClearPass server:

Num.	ClearPass/RADIUS VSA	Type	Description
6	Alcatel-Lucent-Port-Desc	string	<p>Description of the port. This attribute is currently defined in the Alcatel dictionary as:</p> <p>RADIUS attribute type = 26 (VSA) VSA Vendor ID = 800 VSA Type = 26 VSA format = string</p> <p>This attribute is included in all RADIUS messages sent by Alcatel-Lucent OmniSwitch (Access-Request, Accounting-Request Start, Accounting-Request Interim and Accounting-Request Stop). The attribute is set with the alias configured for the port. When the alias is not set, VSA will be an empty string.</p>
100	Alcatel-Access-Policy-List	string	Configures ClearPass to the policy list associated with the UNP.
101	Alcatel-Redirect-URL	string	Configures ClearPass to send redirection URL as part of RADIUS response redirecting the user Web traffic.

Importing the Alcatel-Lucent Dictionary into CPPM

Perform the following to import the VSA dictionary into the CPPM server:

- 1 Download the **Alcatel-Lucent-Enterprise.xml** file from the Service & Support website.
- 2 Click on **Dictionary->Import Dictionary** and browse for the *Alcatel-Lucent-Enterprise.xml* file.
- 3 Click on **Server Configuration->Reboot** to reboot the server.

Importing the Alcatel-Lucent dictionary into CPPM

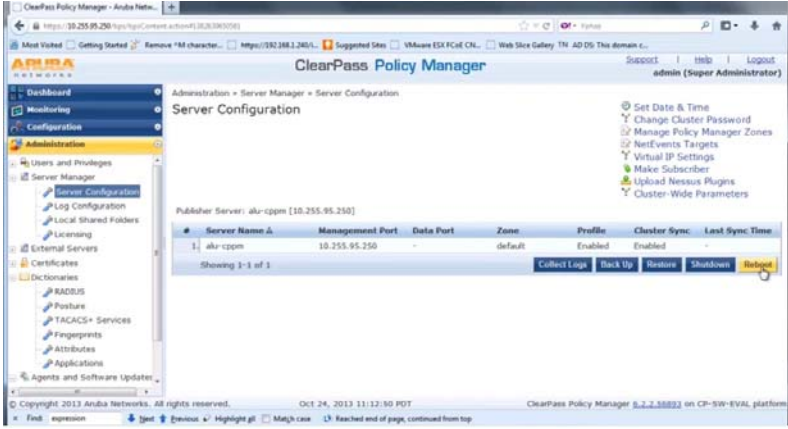
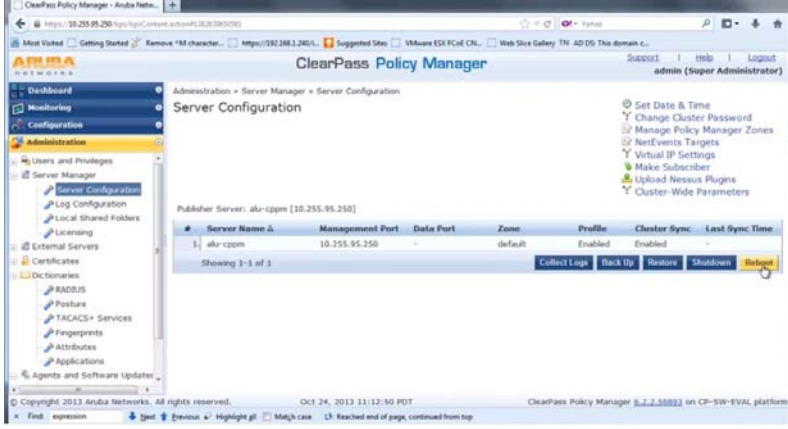
<p>Import Dictionary: Dictionary->Import Dictionary</p>	 <p>The screenshot shows the 'Server Configuration' page in the ClearPass Policy Manager web interface. The left sidebar has 'Administration' > 'Server Manager' > 'Server Configuration' selected. The main content area shows a table with one server entry: 'alr-cppm' with management port 10.255.95.250. The 'Reboot' button at the end of the row is highlighted in yellow.</p>
<p>Reboot CPPM Server Configuration->Reboot</p>	 <p>This screenshot is identical to the one above, showing the 'Server Configuration' page with the 'Reboot' button highlighted in yellow.</p>

Port Bounce

A port bounce is used to terminate a user session and discard all associated session context for non-suplicants. This is done by disabling and re-enabling the port and clearing any authentication state for the devices on the port. A port bounce action is configurable through the **unp redirect port-bounce** command.

- Port bounce is used for MAC authenticated non-suppliant users.
- On receipt of a Disconnect Request (DM) or Change of Authorization (CoA) message, the OmniSwitch determines if the user needs to move or change VLANs.
- If the new UNP specifies a different VLAN ID, the port bouncing feature is enforced as per configuration for non-suplicants.
- When a device changes VLANs and it is the only device on the port, the switch port is bounced to ensure a clean reconnection and get the correct IP address through DHCP.
- Port bouncing is enforced only if the non-suppliant user is the only user on the port. Also if a CoA message is received for a non-suppliant user and port bouncing is disabled globally but is enabled on the port on which the non-suppliant user has been classified, then the port is bounced.

Pause Timer

The switch clears all authentication states of the device by pausing for a period of time. The value for this period of time is configurable through the **unp redirect pause-timer** command.

When non-suppliant devices are detected, the switch must pause for some period of time before redirection to the specified URLs. The pause mechanism is enforced when the following conditions are met.

- COA message received by the switch indicates VLAN movement for the non-suppliant user, and
- Port bouncing is disabled for the user port or disabled globally for the switch.

The pause mechanism ensures that all traffic from the user is dropped until the global pause timer expires and the corresponding user context is removed.

Note. The Port Bounce and Pause Timer functions apply only to non-suppliant devices. For suppliant devices, there is no difference whether Port Bounce is enabled or Pause Timer is enabled. The user context for suppliant devices is removed by triggering the re-authentication of the suppliant user and the device moves into a new UNP Edge profile and VLAN after re-authentication.

Configuring OmniSwitch Interaction with the CPPM

BYOD is supported on UNP ports for supplicant and non-supplicant registered and guest users and devices. The BYOD solution leverages the existing Access Guardian UNP capability and is applicable only on UNP ports. The following general configuration tasks are required to ensure the necessary interaction between an OmniSwitch and the CPPM server:

- Configure the CPPM server as an AAA RADIUS server.
- Set the switch to use the CPPM server for 802.1X and MAC authentication. The authentication process will determine the UNP Edge profile to which BYOD users are classified.
- Configure the UNP profiles that will be returned from the CPPM server. Enable the redirect flag on each of these profiles.
- Configure the CPPM server as the redirect server for the switch.
- Configure UNP port-based functionality on the switch ports that will connect to the user devices.
- Configure the OmniSwitch to relay DHCP traffic to the CPPM server as well as the DHCP server, which assigns the IP addresses to the clients connected to the switch. CPPM uses this information to assist with device profiling.
- Configure the CPPM server with the IP address of the OmniSwitch. In addition, configure the CPPM with the same shared secret that was assigned through the AAA RADIUS server configuration on the OmniSwitch.
- Configure the CPPM server with the required services (for example, MAC authentication, 802.1x, and any generic RADIUS enforcement service) to support the following features.
 - Device profiling
 - Device Onboarding
 - Guest Registration
 - Posture check
 - Captive portal

The following generic configuration examples apply only to the OmniSwitch components for interaction with a CPPM server. For more detailed application examples, refer to [“BYOD Application Examples” on page 31-95](#).

Configuring the CPPM server as an AAA RADIUS Server

The CPPM server must be configured on the OmniSwitch as an AAA RADIUS server that will handle 802.1X and MAC authentication requests from the switch. Optionally, the OmniSwitch can also be set to use the CPPM server for 802.1X and MAC accounting sessions as well. For example:

```
-> aaa radius-server cppm host 192.168.1.244 key e47ac0f11e9fa869 retransmit 3
timeout 2 auth-port 1812 acct-port 1813
-> aaa device-authentication 802.1x cppm
-> aaa device-authentication mac cppm
-> aaa accounting 802.1x cppm
-> aaa accounting mac cppm
```

Configuring UNP Edge Profiles

Users connected to UNP-enabled ports are moved into a specific UNP Edge profile based on the outcome of the authentication process. This type of profile is created using the **unp edge-profile** command. For example:

```
-> unp edge-profile UNP-guest
-> unp edge-profile UNP-restricted
```

To support interaction with the CPPM server, the same Edge profile name must be configured on both the OmniSwitch and the CPPM server. In addition, the redirect flag for the OmniSwitch profile must be enabled. For example:

```
-> unp edge-profile UNP-guest redirect enable
-> unp edge-profile UNP-restricted redirect enable
```

Once an Edge profile is created with the redirect flag enabled, then the profile must be mapped to a VLAN ID. Users classified into the Edge profile are dynamically assigned to the associated VLAN ID. To assign a VLAN ID to an Edge profile, use the **unp vlan-mapping edge-profile** command. For example:

```
-> unp vlan-mapping edge-profile UNP-guest vlan 100
-> unp vlan-mapping edge-profile UNP-restricted vlan 455
```

Configuring Redirection with Dynamic URLs

The redirect server and the URL returned by the server are used to present guest users with different web pages depending on what state of authentication they are in. HTTP traffic from the user is redirected towards the URL returned by the server. Use the **unp redirect-server** command to specify the IP address of the redirect server, which should match the IP address in the returned URL. For example:

```
-> unp redirect-server ip-address 192.168.1.244
```

If the OmniSwitch redirect server IP address does not match the redirect IP address in the CPPM server configuration, HTTP traffic is not redirected to the URL.

To allow the user device to access other servers (such as a remediation server), use the **unp redirect allowed-name** command. For example:

```
-> unp redirect allowed-name server2 ip-address 10.0.0.20 ip-mask 255.0.0.0
```

Configuring a Custom Redirect Policy

When CPPM returns a UNP with a redirect URL VSA but without an Alcatel-Access-Policy-List VSA, the OmniSwitch applies a built-in QoS policy list to the user. The built-in list allows DNS, ICMP, ARP, DHCP, and redirects Web traffic to the configured redirect CPPM server. However, the administrator may want to apply a custom QoS redirect policy list that will override the built-in policy.

To override the built-in list policy list with a custom policy list for BYOD redirection:

- Create a custom redirect policy list on the OmniSwitch. Make sure the list rules contain the following required items:
 - A QoS service group named “alaRestrictedHttpSG”.
 - A redirect module policy action with the **byod** option.
- Configure CPPM to return the OmniSwitch list name in the Alcatel-Access-Policy-List VSA. The policy list name in the VSA must match the name of the custom redirect policy list.

The following is an example of a custom QoS redirect policy list:

```

-> policy service http80 destination tcp-port 80
-> policy service http8080 destination tcp-port 8080
-> policy service https443 destination tcp-port 443
-> policy service group alaRestrictedHttpsG http80 http8080 https443
-> policy port group pgl 1/1/1-20
-> policy condition byod service group alaRestrictedHttpsG
-> policy condition cppm source port group pgl destination ip 135.254.163.143
-> policy action byod_action redirect module BYOD
-> policy action cppm
-> policy rule byod_rule condition byod action byod_action no default-list
-> policy rule cppm condition cppm action cppm no default-list
-> policy list req_policy_list type unp
-> policy list req_policy_list rules byod_rule cppm
-> qos apply

```

In this example, the custom QoS redirect policy list named “req_policy_list” is created with the required items (highlighted in blue). To allow this custom policy list to override the built-in policy, the CPPM is configured to return the “req_policy_list” list name in the Alcatel-Access-Policy-List VSA.

Configuring UNP Port Authentication

UNP functionality and authentication settings must be enabled on the switch ports for the authentication process to begin. Use the **unp** configuration commands to enable UNP functionality on a port and specify the type of authentication to apply to traffic received on that port. For example:

```

-> unp port 1/1/4
-> unp port 1/1/4 802.1x-authentication enable
-> unp port 1/1/4 mac-authentication enable
-> unp port 1/1/4 802.1x-authentication failure-policy mac-authentication

```

In this example, both 802.1X and MAC authentication is enabled on UNP port 1/1/4. In addition, an 802.1X authentication failure policy is configured for the port to direct the switch to attempt MAC authentication after a device on port 1/1/4 fails 802.1X authentication. This is particularly helpful when a guest device with built-in 802.1X credentials fails the initial 802.1X authentication process.

Configuring Port Bounce

Port bouncing is used to force a re-authentication for non-suppliant devices. By default, the port bounce action is enabled on all ports. Use the **unp redirect port-bounce** command to change the port bounce status. For example:

```

-> unp port 1/1/4 redirect port-bounce disable
-> unp port 1/1/4 redirect port-bounce enable

```

If a port is not specified with the **unp redirect port-bounce** command, the status is changed on a global basis for all UNP ports. For example:

```

-> unp redirect port-bounce disable

```

The port-level setting overrides the global setting for the port bounce operation.

Configuring the Pause Timer

The pause timer specifies an amount of time during which traffic from non-suppliant devices is filtered. By default, the pause time is set to zero. Use the **unp redirect pause-timer** command to set the pause timer value, in seconds. For example:

```

-> unp redirect pause-timer 120

```

BYOD Authentication Process Overview

This section describes the basic BYOD process with respect to the OmniSwitch interaction with the ClearPass server.

Authentication for Registered Devices (802.1x)

The BYOD solution provides the following authentication process for registered devices (for example, IT issued employee devices):

- 1 When 802.1X authentication is enabled on a UNP port and the OmniSwitch detects a user device on that port, the authentication process is triggered to classify the user.
- 2 The OmniSwitch sends a request to the ClearPass server that authenticates the user based on user credentials and the profiles and policies configured on the ClearPass server.
- 3 ClearPass classifies the user to a registered UNP and returns the UNP information to the OmniSwitch.
- 4 The OmniSwitch assigns the user to the UNP obtained from the ClearPass server.

Authentication for Network Devices (MAC Authentication)

The BYOD solution provides the following MAC authentication process for network devices such as IP phones, printers, or access points.

- 1 When MAC authentication is enabled on a UNP port and the OmniSwitch detects a device on that port, the MAC authentication process is triggered to classify the device.
- 2 The OmniSwitch sends a request to the ClearPass server that authenticates the device based on the devices MAC address and the profiles and policies configured on the ClearPass server.
- 3 ClearPass classifies the device to a UNP and returns the UNP information to the OmniSwitch.
- 4 The OmniSwitch assigns the device to the UNP obtained from the ClearPass server.

Authentication for Guest Devices and Employee Onboarding

The BYOD solution provides the following authentication process for guest devices and employee personal devices:

- 1 When MAC authentication is enabled on a UNP port and the OmniSwitch detects a device on that port, the MAC authentication process is triggered to classify the device.
- 2 ClearPass initially classifies the device into a temporary UNP and returns a redirection URL that allows for guest registration or employee onboarding.
- 3 The OmniSwitch assigns the user to the temporary UNP name returned from CPPM. Since redirection is also set, all DHCP or DNS traffic is allowed but HTTP traffic from the user is redirected towards the URL returned with the UNP.
- 4 The user is presented with a guest login page or an onboarding page to enter user credentials.
- 5 ClearPass determines the appropriate role of the user after performing registration and sends the final UNP to the OmniSwitch through a RADIUS CoA request or through a RADIUS Access-Accept packet for onboarding.

Using the Multicast Domain Name System

The Multicast Domain Name System (mDNS) is a resolution service that is used to discover services on a LAN. mDNS allows the resolution of host names to IP addresses within small networks without the need of a conventional DNS server. The mDNS protocol uses IP multicast User Datagram Protocol (UDP) packets and is implemented by Apple Bonjour, Avahi (LGPL), and Linux NSS-mDNS. In a BYOD network, mDNS is leveraged by providing wireless guests and visitors access to network devices, such as printers.

To resolve a host name, the mDNS client broadcasts a query message asking the host having that name to identify itself. The target machine then multicasts a message that includes its IP address. All machines in that subnet will use that information to update their mDNS caches.

For example, the Apple's Bonjour architecture implements the following three fundamental operations to support zero configuration networking service:

- Publication (Advertising a service)
- Discovery (Browsing for available services)
- Resolution (Translating service instance names to address and port numbers for use)

Quick Steps for Configuring mDNS

The mDNS feature is enabled on the OmniSwitch edge switch to support the mDNS service and the Bonjour capable device connected to the OmniSwitch.

To set up the mDNS service on the OmniSwitch, proceed as follows:

- 1 Create a GRE tunnel interface on the OmniSwitch. For example:

```
-> ip interface byod_dev address 1.1.1.1/24 tunnel source 1.1.1.1 destination  
1.1.1.2 protocol gre
```

- 2 Associate the interface created in Step 1 with the mDNS tunnel relay using the [mdns-relay tunnel](#) command. For example, the following command associates the “byod_dev” interface with the mDNS tunnel relay:

```
-> mdns-relay tunnel byod_dev
```

- 3 Enable the mDNS feature on the switch using the [mdns-relay](#) command. For example:

```
-> mdns-relay enable
```

Notes.

- Configure the GRE tunnel interface before attempting to associate the interface with the mDNS tunnel relay. An IP address is required to bring the interface up; if necessary, specify a dummy IP address when configuring the interface.
 - Only a Layer 2 GRE tunnel is supported.
 - The GRE tunnel must also be configured on the WLAN controller. Refer to the OmniAccess WLAN user guide for additional information on configuring a WLAN controller.
-

mDNS Work Flow

The following diagram represents an mDNS work flow setup. The wireless clients connected to Access point 1 (AP1) or Access Point 2 (AP2) request for the mDNS service offered.

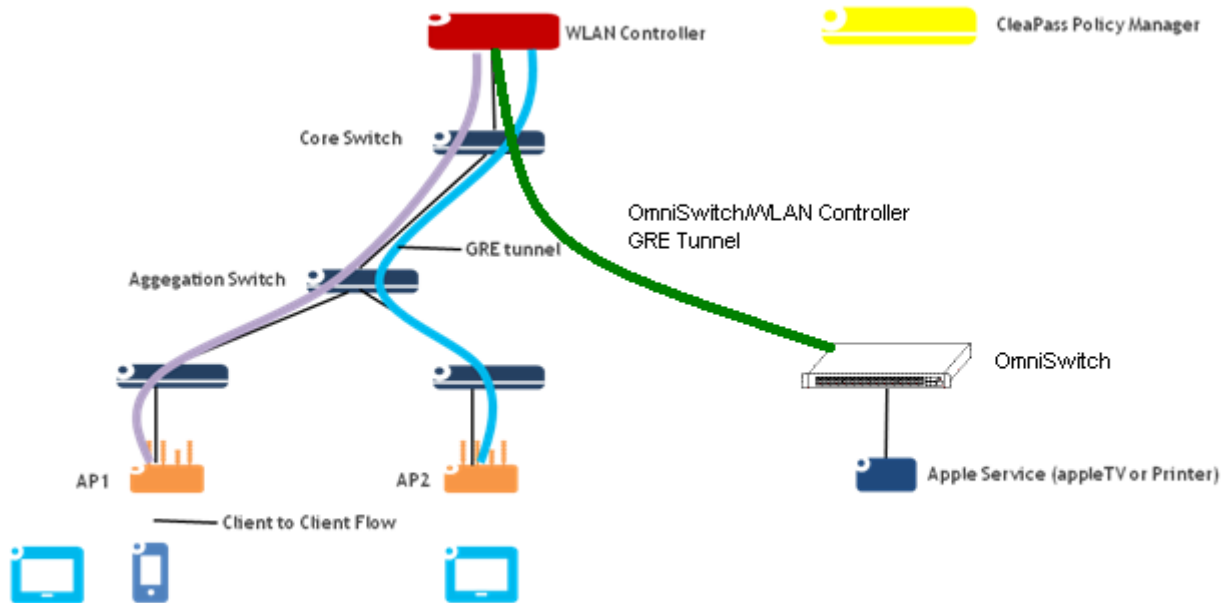

The mDNS feature is enabled on the OmniSwitch to support the mDNS service. A Layer 2 GRE tunnel interface is configured from the WLAN controller to the OmniSwitch to relay the mDNS messages.

The mDNS message from the Bonjour capable wired service device is encapsulated and relayed from the OmniSwitch to the configured WLAN controller over the GRE tunnel. The WLAN controller then relays the mDNS messages received via the OmniSwitch GRE tunnel to the APs over the AP GRE tunnels.

Note. The WLAN controller uses a multicast optimization algorithm and forwards Bonjour response messages to targeted user devices, instead of all devices on all APs. This limits the unnecessary flooding of the Bonjour/mDNS traffic to improve the Wi-Fi performance.

Disabling mDNS on the Switch

To disable the mDNS relay feature on the switch use the `mdns-relay` command. For example:

```
-> mdns-relay disable
```

When the mDNS relay is disabled on the switch, the mDNS packets are handled in the conventional way.

Verifying the mDNS Configuration

To verify the mDNS configuration on the switch, use the `show mdns-relay config` command. The show command displays the current admin status of the mDNS relay feature and the GRE tunnel interface used for mDNS relay. For example:

```
-> show mdns-relay config
mdns-relay admin status      : disabled
mdns-relay tunnel interface  : byod_dev
mdns-relay operational status : down
```

For more information about the mDNS configuration and show commands, see the *OmniSwitch AOS Release 8 CLI Reference Guide*.

Using the Simple Service Discovery Protocol

The Digital Living Network Alliance (DLNA) is a standards organization that defines the guidelines for multimedia devices. It also certifies communication between devices allowing them to discover and recognize each other and share digital content. DLNA uses Universal Plug and Play (UPnP) for media management, discovery, and control. DLNA/UPnP uses the Simple Service Discovery Protocol (SSDP) to discover services, similar to Bonjour using mDNS for the same purpose. In the AirGroup solution, the WLAN controller acts as Bonjour and DLNA gateways allowing Layer 2 discovery protocols, such as mDNS and SSDP, to extend across Layer 3 boundaries through the gateway.

Along the lines of zero network configuration already supported by the OmniSwitch with mDNS, support of SSDP Relay for DLNA/UPnP enables the OmniSwitch to allow non-Apple devices to also discover services with minimal configuration by the administrator. DLNA/UPnP uses SSDP for dynamic discovery of services. The WLAN controller AirGroup feature has support for DLNA and acts as a DLNA controller, in addition to the support for mDNS. Similar to the OmniSwitch implementation of mDNS, the OmniSwitch relays SSDP packets to the WLAN controller through a Layer 2 GRE tunnel.

How SSDP Relay Works

All the SSDP packets coming in on an OmniSwitch are intercepted and tunneled through a GRE tunnel to the WLAN controller (acting as a gateway). The GRE tunnel is setup between the switch and the WLAN controller to tunnel both mDNS and SSDP frames. Similarly, traffic towards the SSDP clients/servers are sent back from the WLAN controller to the switch through the GRE tunnel. The reverse traffic is also intercepted and then sent unicast or multicast from the switch to the respective ports.

Messages Received by the OmniSwitch from Wired SSDP Devices

SSDP messages coming from wired SSDP service devices are relayed from the OmniSwitch to the WLAN controller using the associated GRE tunnel interface. The WLAN controller only supports Layer 2 GRE for SSDP, so frames sent from the OmniSwitch are encapsulated as follows:

DA-MAC	SA - MAC	IP Header	Payload
Gateway MAC to reach WLAN controller/ WLAN controller MAC	OmniSwitch MAC	Src IP: OmniSwitch IP Dst IP: WLAN controller IP IP protocol: GRE(47) GRE VER 00 00 GRE TYPE 00 00 (indicating L2 frame in the payload)	SSDP frame from the wired service/client (appended with 802.1q tag)

Messages Received by the OmniSwitch from the WLAN Controller

SSDP messages coming from the WLAN controller through the Layer 2 GRE tunnel interface are relayed towards the client device. When the OmniSwitch receives the encapsulated packets:

- The original SSDP frame is extracted from the GRE packet with the Layer 2 header.
- The switch obtains the VLAN ID from inside the 802.1q header of the SSDP frame and floods the frame on that VLAN (untagged or tagged based on the egress port frame) towards the client.

SSDP frames received from the WLAN controller are encapsulated as follows:

DA-MAC	SA - MAC	IP Header	Payload
OmniSwitch MAC	WLAN controller MAC/intermediate router MAC	Src IP: WLAN controller IP Dst IP: OmniSwitch IP IP protocol: GRE GRE VER 00 00 GRE TYPE 00 00 (indicating L2 frame in the payload)	SSDP frame destined to the wired service/ client (appended with 802.1q tag)

Configuring SSDP Tunnel Relay

The SSDP relay feature is enabled on the OmniSwitch edge switch to support the relay of SSDP packets between DNLA-capable devices and the WLAN controller. The following steps provide a quick tutorial for configuring SSDP Relay on the OmniSwitch:

- 1 Create a GRE tunnel interface on the OmniSwitch. Use the WLAN controller IP address as the destination address for the GRE tunnel interface. For example:

```
-> ip interface byod_dev address 1.1.1.1/24 tunnel source 1.1.1.1 destination
1.1.1.2 protocol gre
```

- 2 Associate the interface created in Step 1 with SSDP relay using the **ssdp-relay tunnel** command. For example, the following command configures the “byod_dev” tunnel interface to relay SSDP packets:

```
-> ssdp-relay tunnel byod_dev
```

- 3 Enable the SSDP relay feature on the switch using the **ssdp-relay** command. For example:

```
-> ssdp-relay enable
```

- 4 To verify the SSDP relay configuration on the switch, use the **show ssdp-relay config** command. For example:

```
-> show ssdp-relay config
ssdp-relay admin status      : disabled,
ssdp-relay tunnel interface  : byod_dev,
ssdp-relay operational status : down
```

Configuration Guidelines

Consider the following guidelines when configuring SSDP Relay functionality for the switch:

- Configure the GRE tunnel interface before attempting to associate the interface with the SSDP tunnel relay. An IP address is required to bring the interface up; if necessary, specify a dummy IP address when configuring the interface.
- The GRE tunnel must also be configured on the WLAN controller. Refer to the OmniAccess WLAN user guide for additional information on configuring a WLAN controller.
- The SSDP and mDNS relay features both require an association with a GRE tunnel IP interface. If both of these features are required on the switch, configure both to use the same tunnel interface. There is only one Layer 2 GRE tunnel established between the switch and the WLAN controller, so both features need to use the same GRE tunnel.
- Only a Layer 2 IPv4 GRE tunnel is supported. However, IPv6 SSDP frames from the client are also relayed through the IPv4 GRE tunnel, as the payload includes the Layer 2 headers (only Layer 2 GRE mode is supported by the WLAN controller) regardless of the inner IPv6 header.

Application Example 1: Wired DNLA-Capable Client

In this application example, an active wired DLNA-capable client is attempting to print to a DNLA printer and stream to a DNLA TV. All the devices are connected to the OS6860, but the SSDP discovery phase has to flow through the WLAN controller. As a result, the Layer 2 GRE tunnel is required to handle the initial contact between the devices. Once communication is established, subsequent traffic flows directly between the devices without going through the controller.

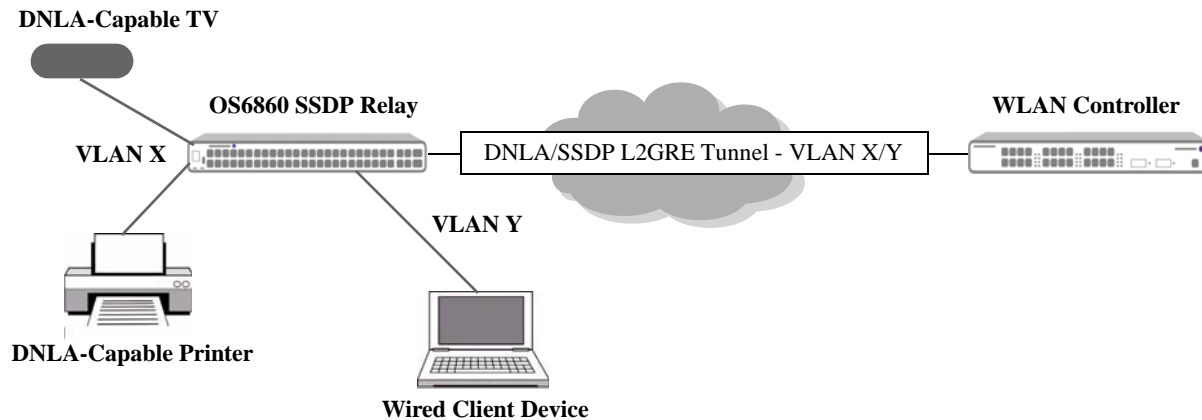

In this example:

- The WLAN controller handles the SSDP discovery process between the wired client and end service devices. Encapsulated SSDP packets are sent between the controller and the OS6860 through the Layer 2 GRE tunnel until discovery is complete.
- The OS6800 relays SSDP packets from the DNLA-capable printer and TV to the WLAN controller through the Layer 2 GRE tunnel. See [“Messages Received by the OmniSwitch from Wired SSDP Devices” on page 31-91](#).
- The OmniSwitch 6860 receives encapsulated SSDP packets through the GRE tunnel from the WLAN controller. The switch then extracts the SSDP frames from the encapsulated packets and forwards them to the destined end service device (DNLA-capable printer or TV). See [“Messages Received by the OmniSwitch from the WLAN Controller” on page 31-91](#).

Application Example 2: Wireless DNLA-Capable Clients

In this application example, wireless DLNA-capable clients are accessing DLNA-capable devices with ClearPass Policy Manager (CPPM) integration for role and location information. All traffic between the wireless clients and the wired devices flows through the WLAN controller.

The CPPM integration is only available for wireless devices. If there are both wired and wireless DLNA-capable clients, the CPPM integration mode cannot be enabled on the WLAN controller. CPPM integration is enabled at the global level; there is no independent control to apply this function only to wireless devices.

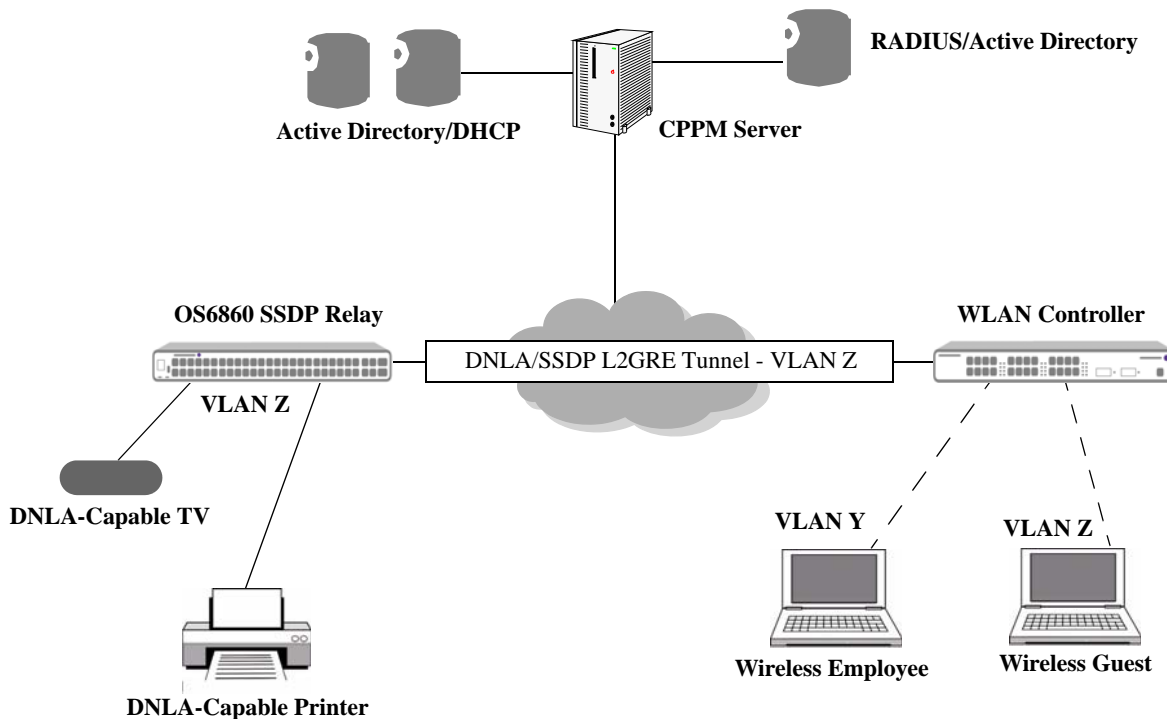

In this example:

- The OS6800 relays SSDP packets from the DNLA-capable printer and TV to the WLAN controller through the Layer 2 GRE tunnel. See [“Messages Received by the OmniSwitch from Wired SSDP Devices” on page 31-91](#).
- The WLAN controller sends a RADIUS request to the CPPM to request the policies needed to determine the end service devices that are available to the wireless clients. The following policies are the type of policies that may be returned:
 - Identity based policies.
 - Role based policies.
 - Location based policies.
 - Time based policies.
- The WLAN controller applies the service policies and sends encapsulated SSDP packets through the Layer 2 GRE tunnel to the end service devices connected to the OS6800.
- The OmniSwitch 6860 receives encapsulated SSDP packets through the GRE tunnel from the WLAN controller. The switch then extracts the SSDP frames from the encapsulated packets and forwards them to the destined end service device (DNLA-capable printer or TV). See [“Messages Received by the OmniSwitch from the WLAN Controller” on page 31-91](#).

BYOD Application Examples

The application scenarios provide various examples of how the ClearPass server and the OmniSwitch can be leveraged to provide different network access levels and UNPs for employees, guests, and other network-based devices.

In the following contexts the main parameters, such as a UNP name, VLAN ID, and other parameters specified in the application examples, are as follows:

Employee Registered Device – 802.1x Authentication

- UNP = UNP-employee
- VLAN = 96

IP Phone – MAC Authentication

- UNP = UNP-phone
- VLAN = 1002

Guest Device – MAC Authentication with Guest Login

- Registration UNP = UNP-restricted
- Registration VLAN = 96
- Redirect Server = 10.255.95.206
- Guest UNP = UNP-guest
- Guest VLAN = 96

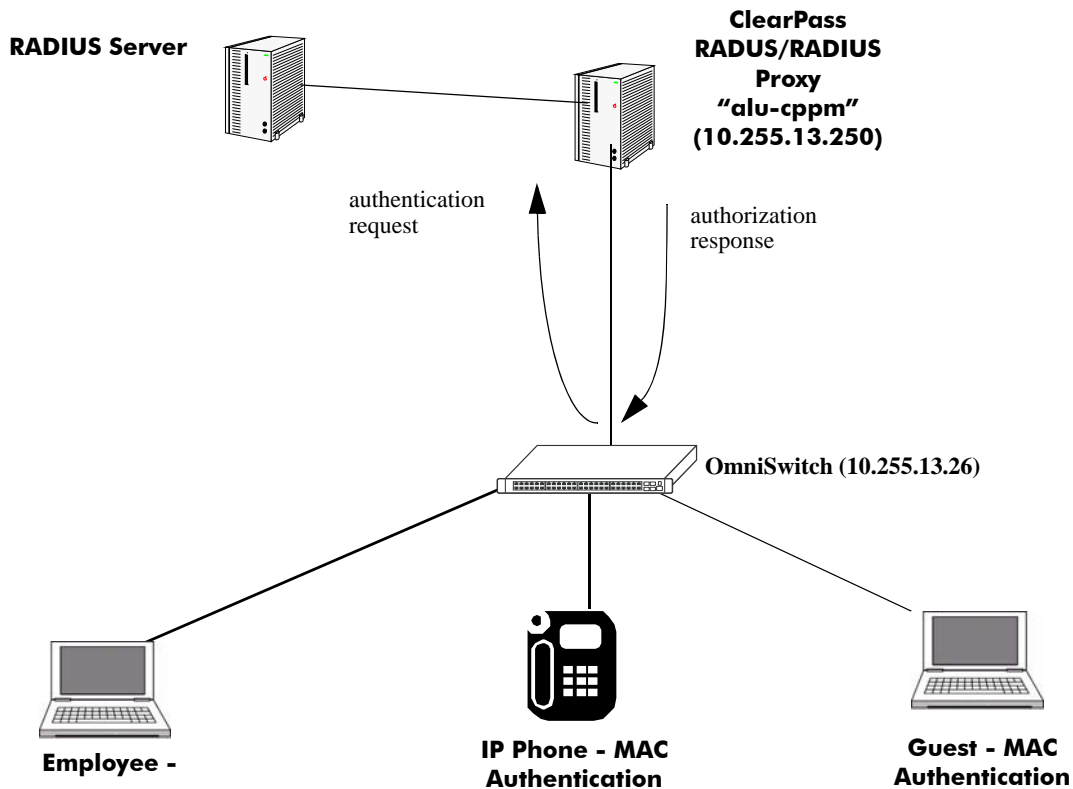

BYOD network with Employee and Guest devices

Application Example 1: 802.1x – OmniSwitch Configuration

The OmniSwitch configuration for an 802.1x supplicant:

1 Enable UNP port-based functionality as follows:

```
-> unp port 1/1/11
-> unp port 1/1/11 802.1x-authentication enable
```

2 Configure 802.1x authentication for ClearPass RADIUS on the OmniSwitch as follows:

```
-> aaa radius-server alu-cppm host 10.255.95.250 key alcatel
-> aaa device-authentication 802.1x alu-cppm
```

3 Configure User Network Profiles as follows:

```
-> unp edge-profile UNP-employee
-> unp vlan-mapping edge-profile UNP-employee vlan 96
```

Application Example 1: 802.1x – ClearPass Configuration

Step 1. ClearPass (802.1x) - Creating employee users and roles

Create user role:
Roles->Add Roles

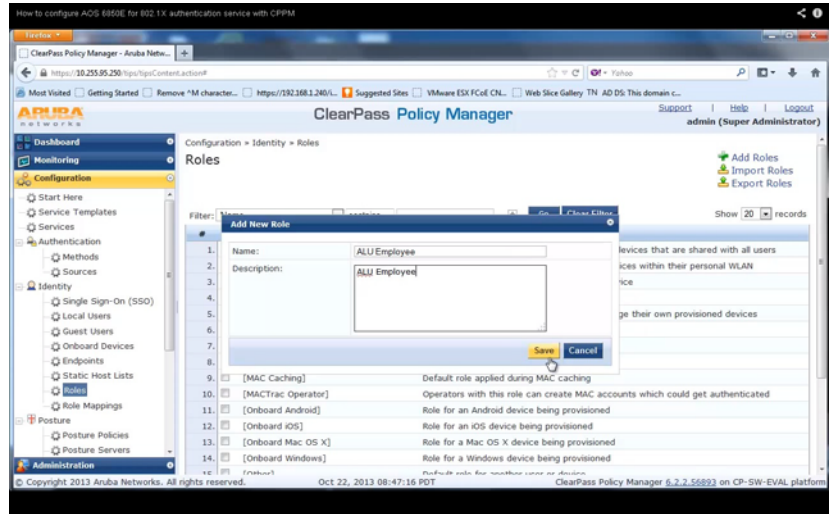

Create users and assign role:
Local Users -> Add Users

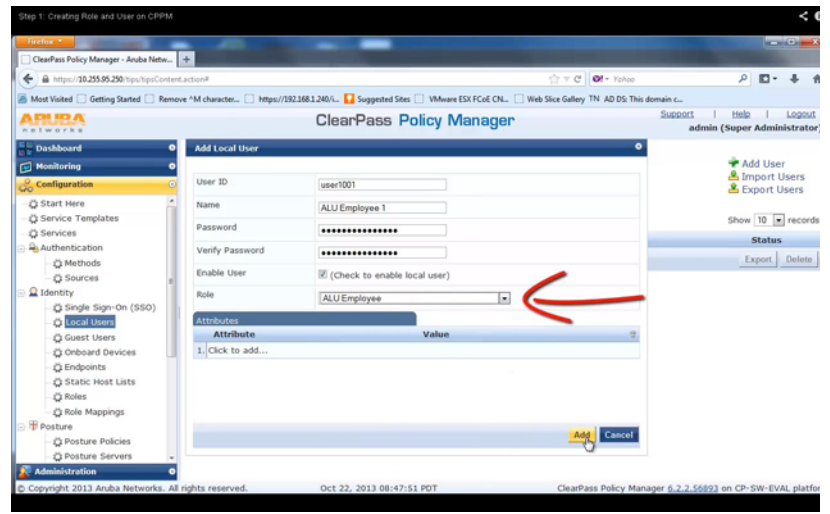

Step 2. ClearPass (802.1x) - Create Profiles and Policies

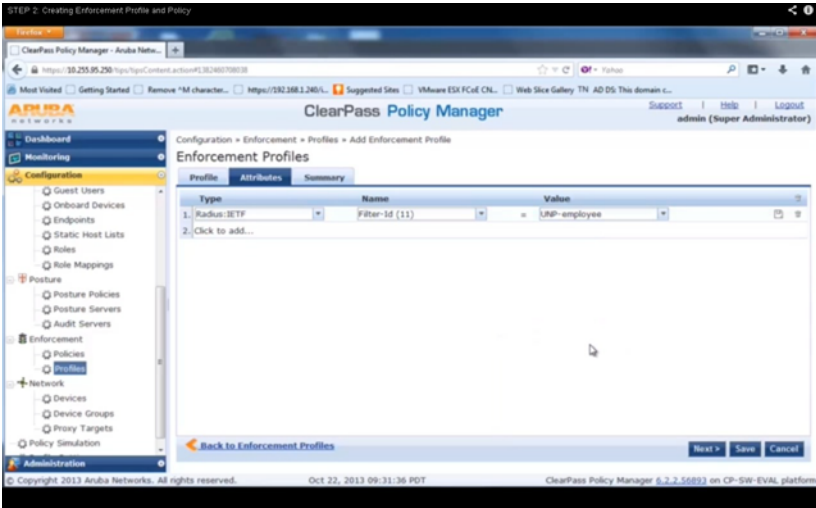
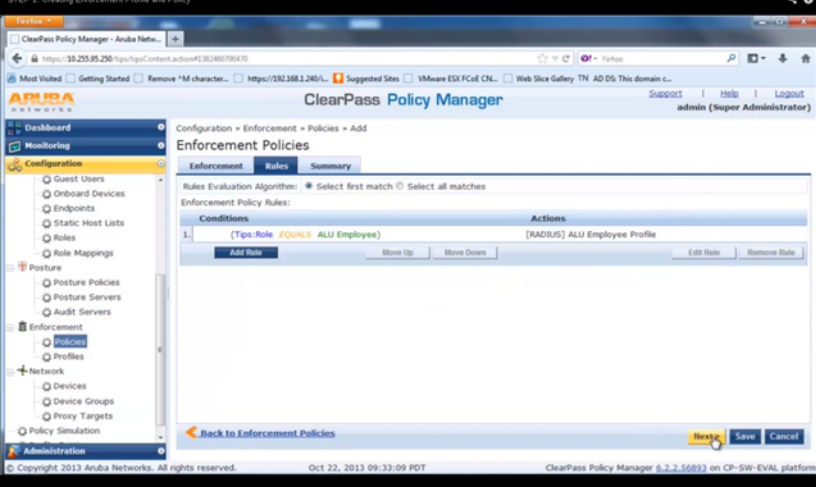
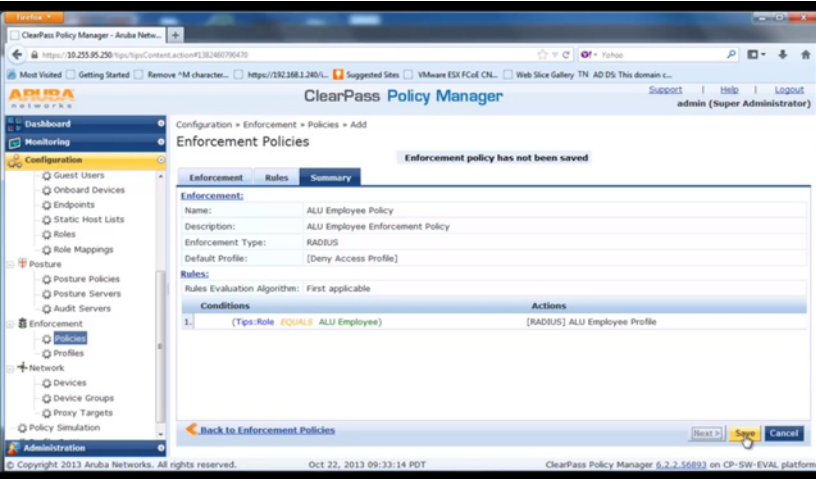
<p>Create Profile:</p> <p>Attributes (tab)</p> <ul style="list-style-type: none"> - Type: Radius:IETF - Filter-ID (11) - Value = UNP-employee (Note: must match UNP Profile on OmniSwitch) 	
<p>Create Enforcement Policy:</p> <p>Rules (tab)</p>	
<p>View Policies Summary</p> <p>Summary</p>	

Step 3. ClearPass (802.1x) - Create 802.1X services

<p>Add OmniSwitch to ClearPass Database</p> <p>Devices (tab)</p>	
<p>Add 802.1x Wired Service</p> <p>Service (tab)</p>	
<p>Configure 802.1x Authentication</p> <p>Authentication (tab)</p>	

Configure Enforcement
Enforcement (tab)

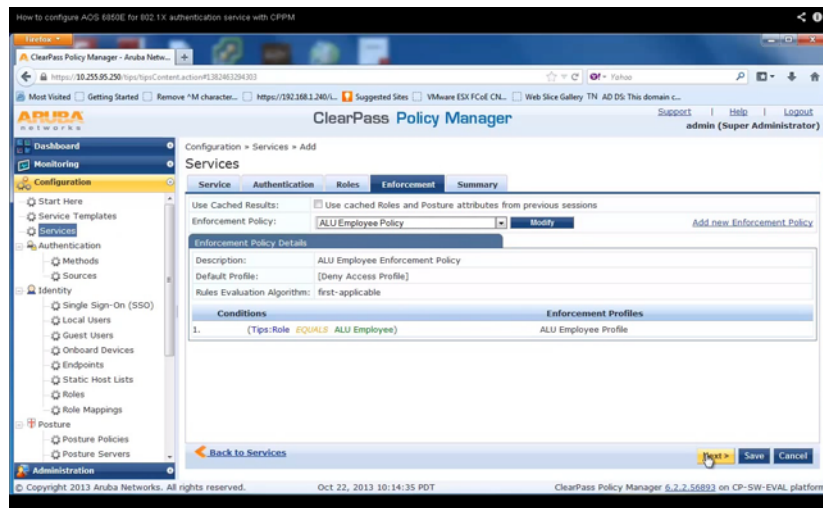

Reorder Authentication
Devices

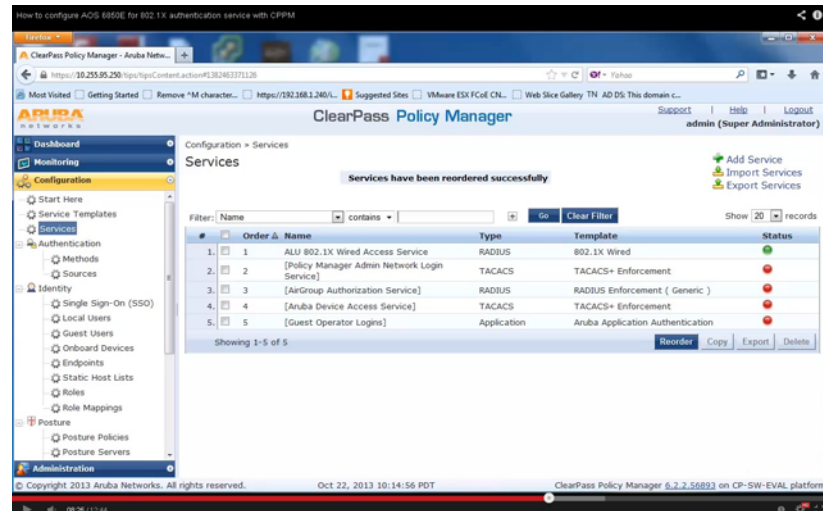

Step 4. ClearPass (802.1x) - Configure PC

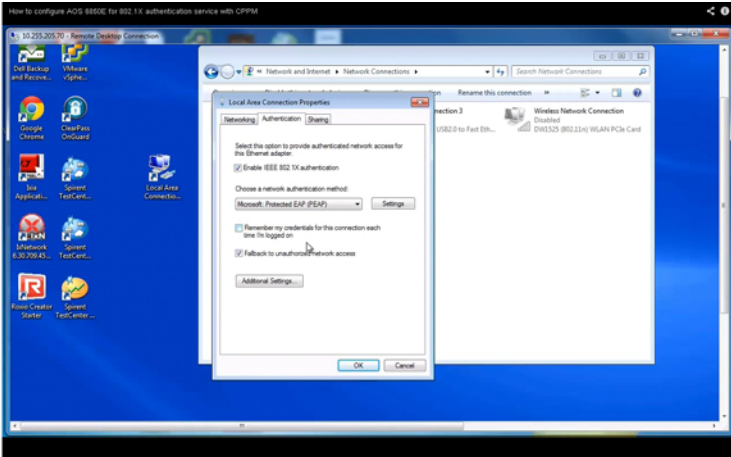
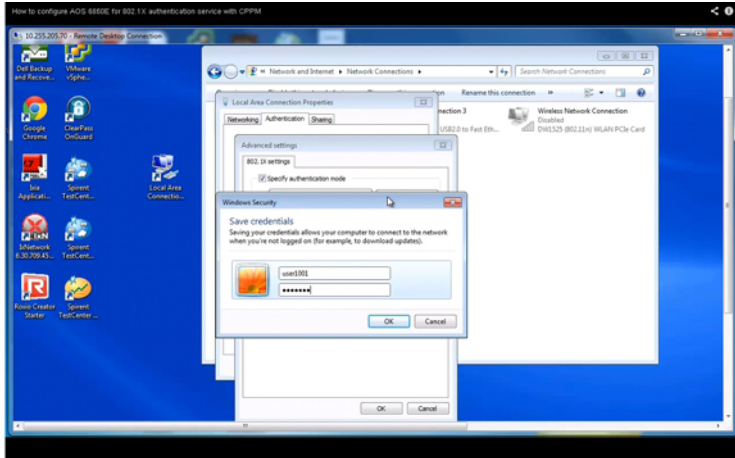
<p>Configure PC Properties</p>	
<p>Configure PC Advanced Settings</p>	

Step 5. ClearPass (802.1x) - Confirm Device Authentication

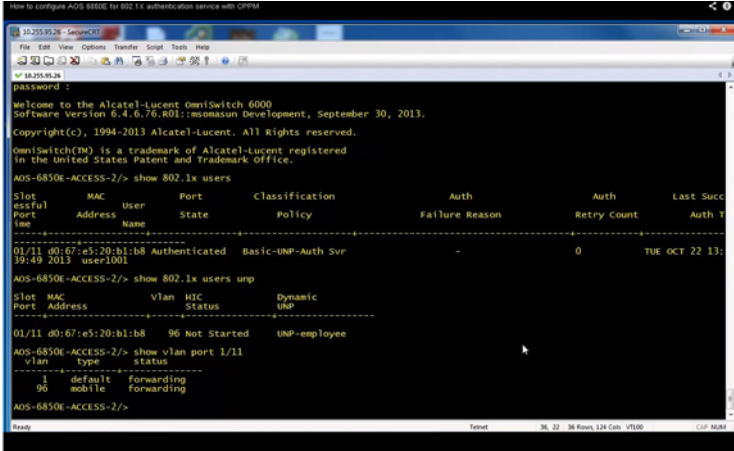
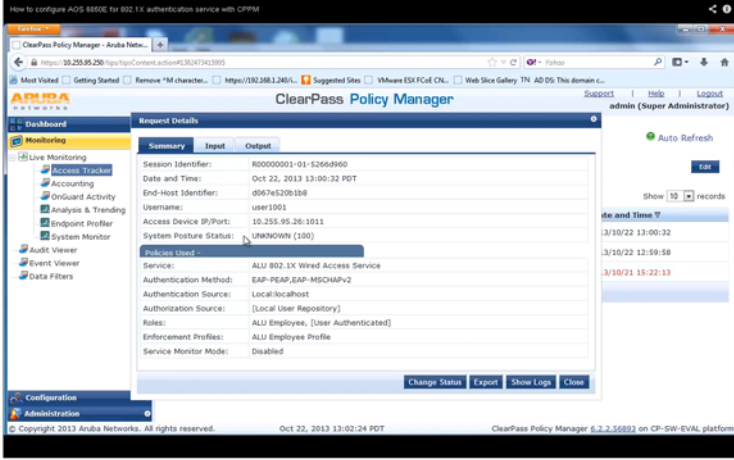
<p>Confirm device Authentication</p> <p>OmniSwitch</p>	 <pre> AOS-6850E-ACCESS-2/ > show 802.1x users ----- Slot MAC User Port Classification Auth Auth Last Succ Port Address Name State Policy Failure Reason Retry Count Auth T ---- - 01/11 00:67:e5:20:b1:b8 Authenticated Basic-UNP-Auth Svr - - 0 TUE OCT 22 13: 19:49 2013 user1001 AOS-6850E-ACCESS-2/ > show 802.1x users urp ----- Slot MAC vlan HIC Dynamic Port Address Status UNP ---- - 01/11 00:67:e5:20:b1:b8 96 Not Started UNP-employee AOS-6850E-ACCESS-2/ > show vlan port 1/11 ----- vlan type status ---- - 1 default Forwarding 96 mobile Forwarding AOS-6850E-ACCESS-2/ > </pre>
<p>Confirm Device Authentication</p> <p>ClearPass</p>	

Application Example 2: IP Phone – OmniSwitch Configuration

The OmniSwitch configuration for a non-suppliant IP phone:

1 Configure UNP port-based functionality as follows:

- > unip port 1/1/13
- > unip port 1/1/13 mac-authentication enable

2 Configure MAC authentication for ClearPass RADIUS on an OmniSwitch as follows:

- > aaa radius-server alu-cppm host 10.255.95.250 key alcatel
- > aaa device-authentication mac alu-cppm

3 Configure User Network Profiles as follows:

- > unip edge-profile UNP-phone
- > unip vlan-mapping edge-profile UNP-phone vlan 1002

Application Example 2: IP Phone – ClearPass Configuration

Step 1. ClearPass (IP Phone) - Creating static host list

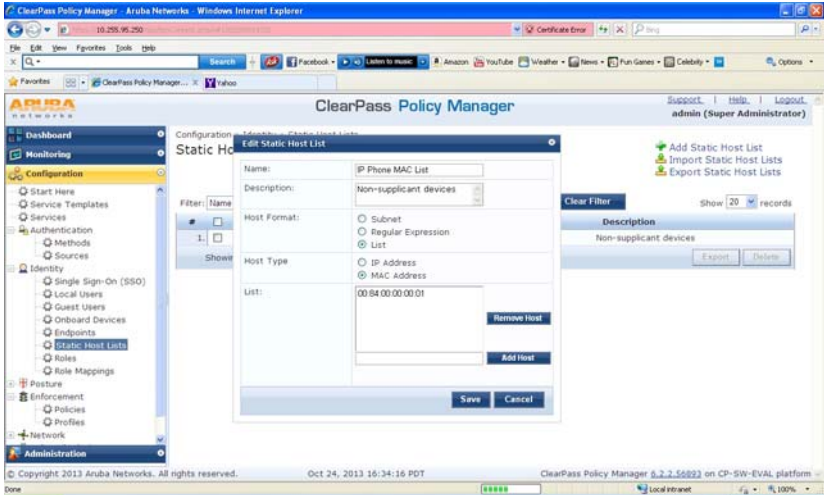
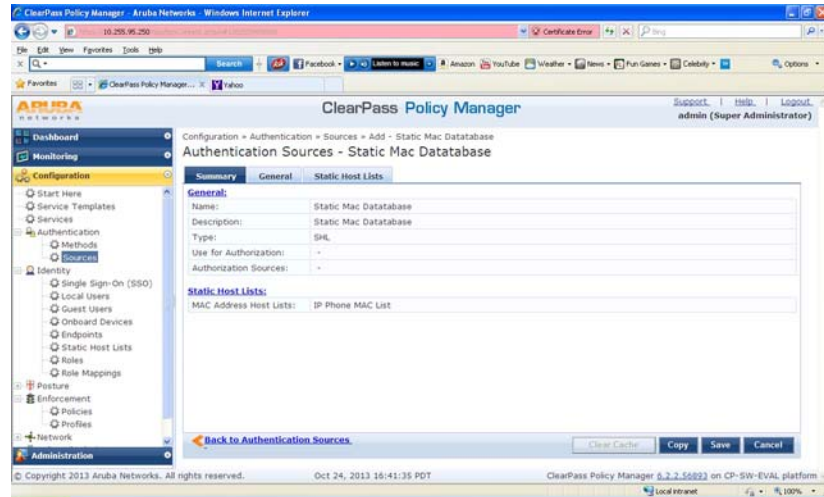
<p>Create static host list:</p> <p>Identity->Static Host List</p>	
<p>Create Authentication Source</p> <p>Authentication-Sources-Add Authentication Source</p> <p>Type: Static Host List Host List: IP Phone MAC List</p>	

Step 2. ClearPass (IP Phone) - Create Profiles and Policies

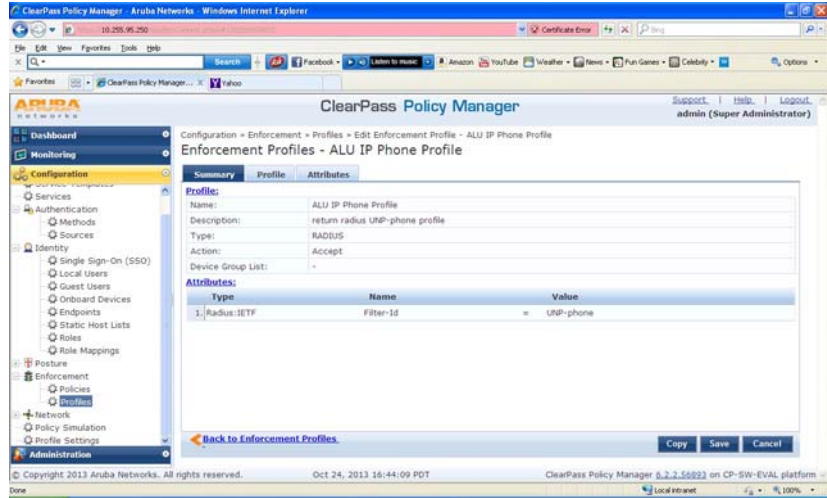
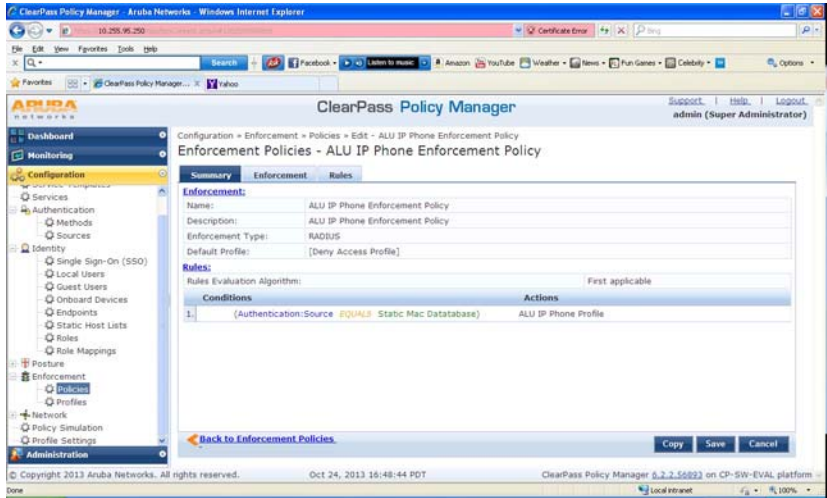
<p>Create Profile:</p> <p>Profile (tab)</p> <ul style="list-style-type: none"> - Name: ALU IP Phone Profile - Template: Aruba RADIUS Enforcement <p>Attributes (tab)</p> <ul style="list-style-type: none"> - Type: Radius:IETF - Filter-ID (11) - Value = UNP-phone (Note: must match UNP Profile on OmniSwitch) 	 <p>The screenshot shows the 'ClearPass Policy Manager' interface. The breadcrumb path is 'Configuration > Enforcement > Profiles > Edit Enforcement Profile - ALU IP Phone Profile'. The 'Attributes' tab is active, showing a table with one attribute: Type 'Radius:IETF', Name 'Filter-Id', and Value 'UNP-phone'.</p>
<p>Create Enforcement Policy:</p> <p>Rules (tab)</p> <ul style="list-style-type: none"> - Type: Authentication - Name: Source - Operator: EQUALS - Value: Static Mac Database - Profile Name: ALU IP Phone Profile 	 <p>The screenshot shows the 'ClearPass Policy Manager' interface. The breadcrumb path is 'Configuration > Enforcement > Policies > Edit - ALU IP Phone Enforcement Policy'. The 'Rules' tab is active, showing a table with one rule: Condition '(Authentication:Source EQUALS Static Mac Database)' and Action 'ALU IP Phone Profile'.</p>

Step 3. ClearPass (IP Phone) - Create MAC Authentication Service

Add MAC Authentication Service

Service (tab)
-Type: MAC Authentication

Authentication (tab)
- **Authentication Sources:** Static MAC Database

Enforcement (tab)
- **Enforcement Policy:** ALU IP Phone Enforcement Policy

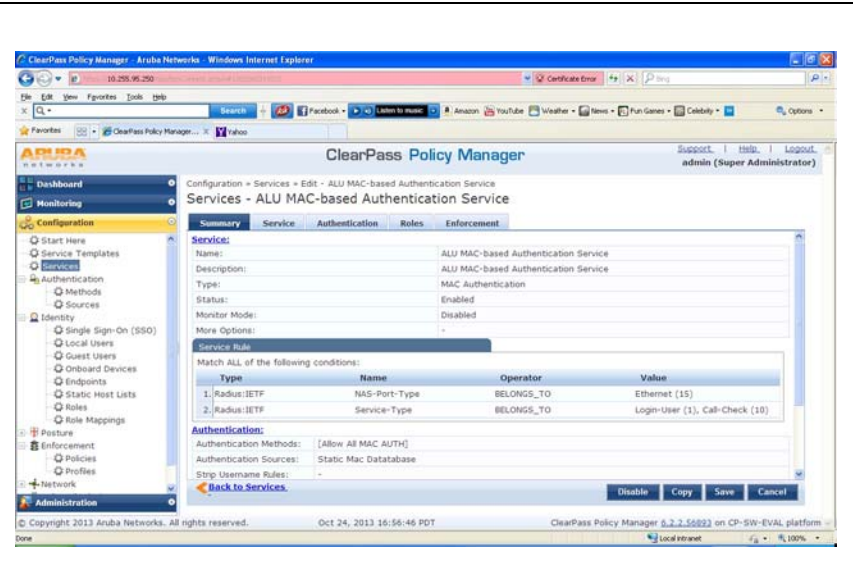

Application Example 3: Guest – OmniSwitch Configuration

The OmniSwitch configuration for guest UNP, VLANs, and redirection:

1 Configure UNP port-based functionality as follows:

```
-> unp port 1/1/13
-> unp port 1/1/13 802.1x-authentication enable
-> unp port 1/1/13 mac-authentication enable
```

2 Configure MAC-authentication for ClearPass RADIUS on an OmniSwitch as follows:

```
-> aaa radius-server alu-cppm host 10.255.95.250 key alcatel
-> aaa device-authentication 802.1x alu-cppm
-> aaa device-authentication mac alu-cppm
-> aaa accounting 802.1x alu-cppm
-> aaa accounting mac alu-cppm
```

3 Configure User Network Profiles and redirect server as follows:

```
-> aaa user-network-profile name "UNP-guest" vlan 96
-> aaa user-network-profile name "UNP-restricted" vlan 96
-> aaa redirect-server alu-cppm ip-address 10.255.95.250
```

Application Example 3: Guest – ClearPass Configuration

Step 1: ClearPass (Guest) - Create Guest Account and Web login page

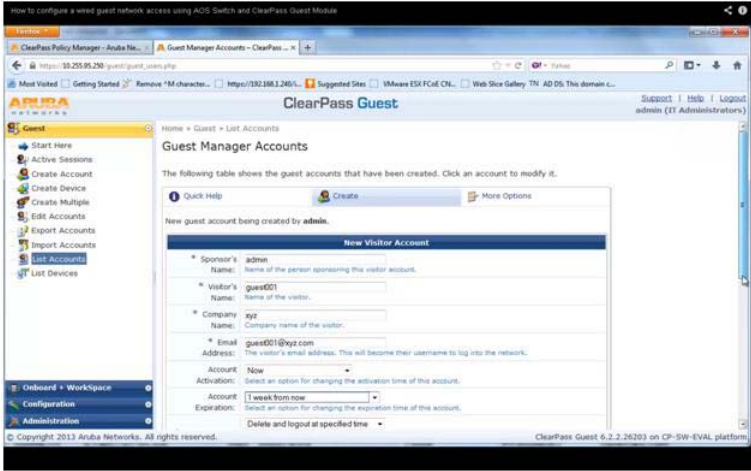
<p>Create guest account</p> <p>Guest->List Accounts</p>	
--	--

Create web login page

Configuration-Web Logins

Name- Alcatel-Lucent Secure Access

Page name: secure-access

Vendor Settings: Alcatel-Lucent

Login Method: Server-initiated

Pre-Auth Check:None

Terms: checked

Default URL: www.google.com

Override Destination: checked

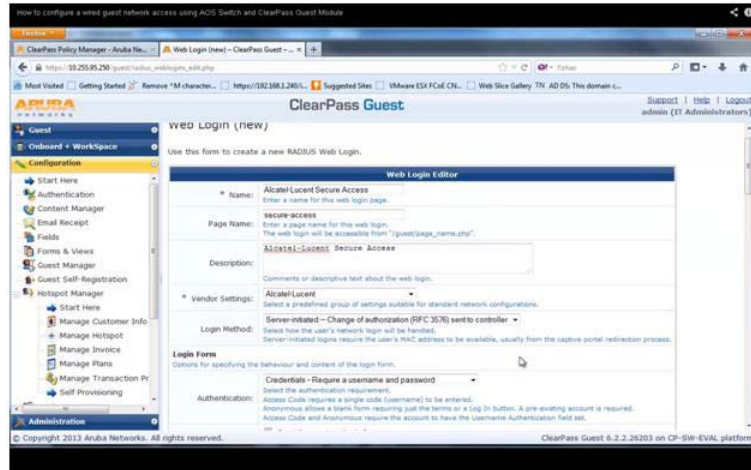

Create custom skin if desired

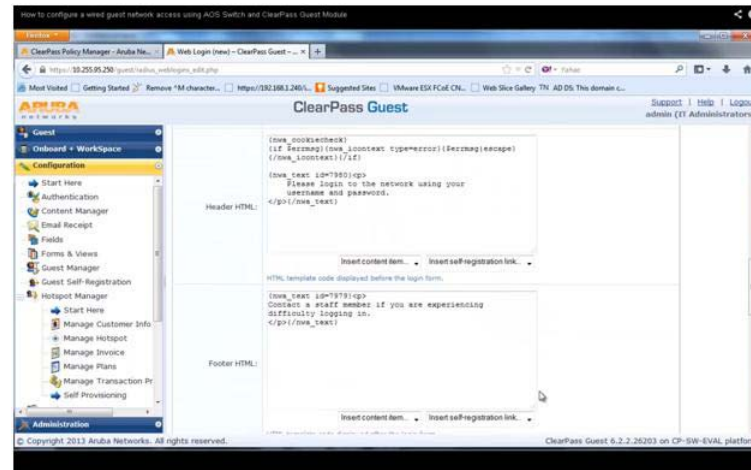

Step 2: ClearPass (Guest) - Create Profiles

Create Restricted Profile:
Enforcement->Profiles
Template: RADIUS Based Enforcement
Name: ALU Restricted Profile
Type: RADIUS
Action: Accept
Attribute Type: Radius:IETF, Alcatel-Lucent-Enterprise
Attribute Name: Filter-ID, Alcatel-Redirection-URL
Attribute Value: UNP-restricted, (redirect URL)

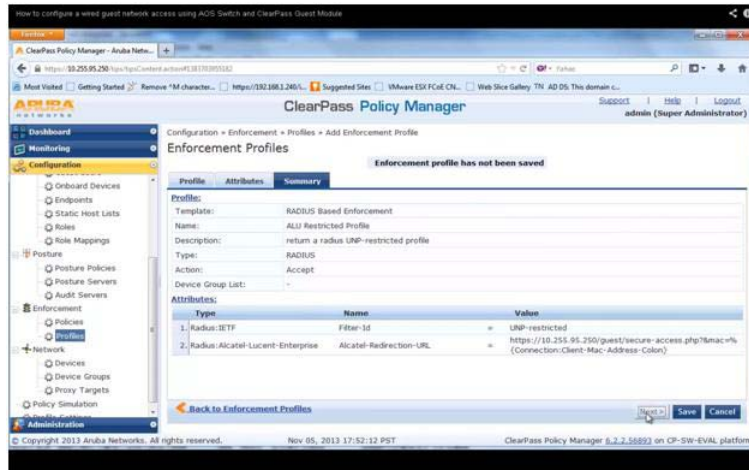

Create Guest Profile:
Enforcement->Profiles
Template: RADIUS Change of Authorization (CoA)
Name: ALU Guest CoA Profile
RADIUS CoA Template: Aruba-Change-User-Role
Attributes Type: Radius:IETF
Attribute Name: Filter-ID
Attribute Value: UNP-guest

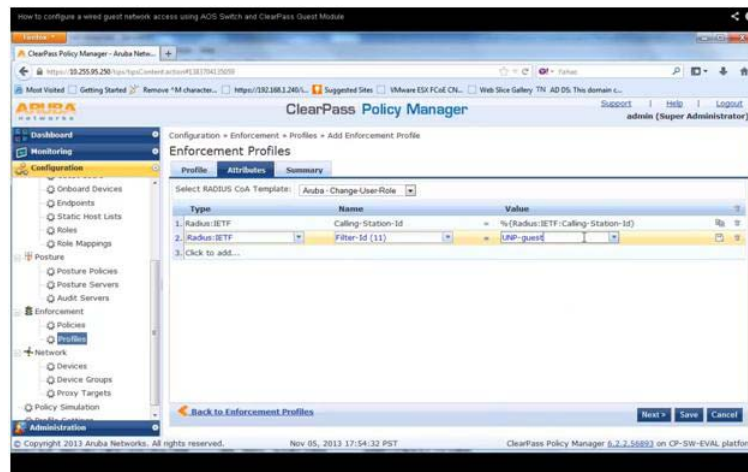

Step 3: ClearPass (Guest) - Create MAC and Web Authentication Services

Add MAC
Authentication Service

Configuration->Services

Type: MAC
Authentication
Name: ALU Wired
MAC Authentication
Service
Monitor Mode:
Disabled
Service Rule Type:
Radius:IETF
Service Rule Name:
NAS-Port-Type
Service Rule
Operator:
BELONGS_TO
Service Rule Value:
Ethernet (15)
Authentication
Methods: Allow All
MAC AUTH
Enforcement Policy:
ALU Wired MAC
Enforcement Policy

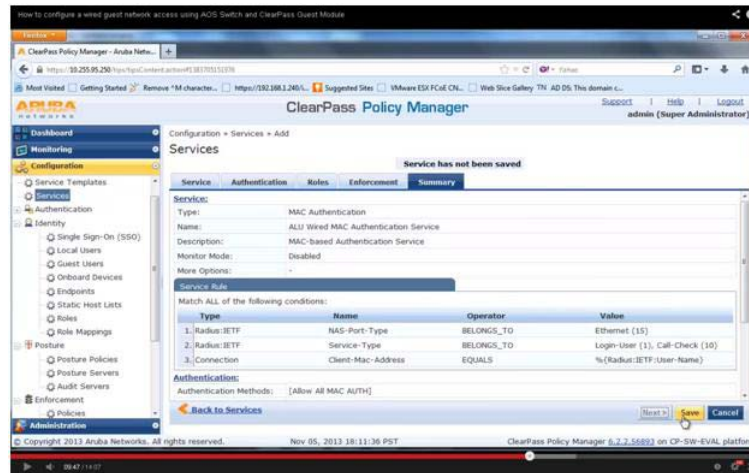

Add Web
Authentication Service

Configuration->Services

Type: Web-based
Authentication
Name: ALU Wired
Captive Portal
Authentication Service
Authentication
Sources: [Guest user
Repository] [Local SQL
DB]
Enforcement Policy:
ALU Wired Captive
Portal Enforcement
Policy

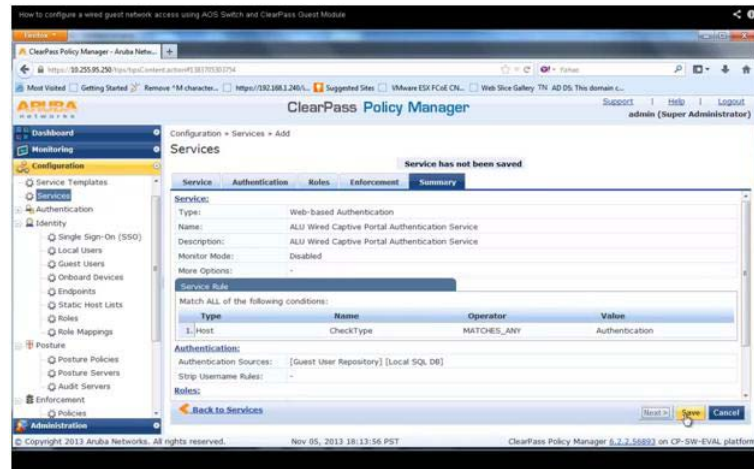

Step 4: ClearPass (Guest) - Login Example

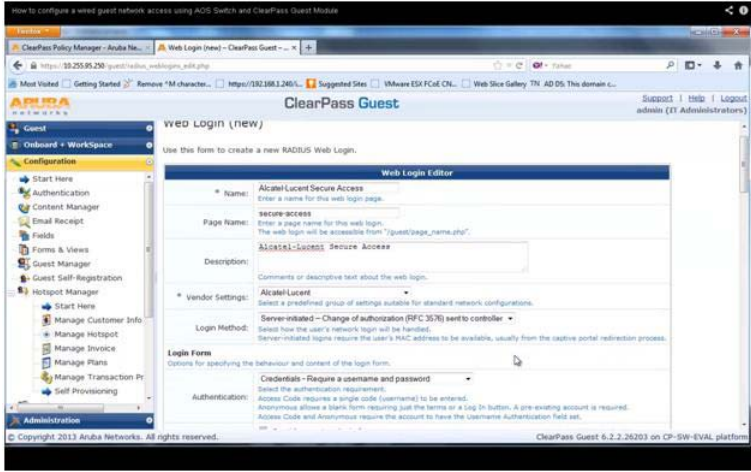
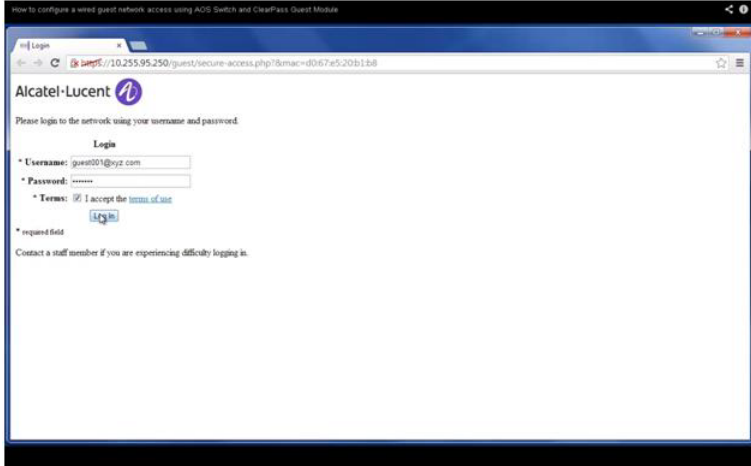
<p>Example Redirect</p>	 <p>The screenshot shows the 'Web Login Editor' configuration page in the ClearPass Guest interface. The page title is 'Web Login (new)'. The configuration includes: <ul style="list-style-type: none"> Name: Alcatel-Lucent Secure Access Page Name: secure-access Description: Alcatel-Lucent Secure Access Vendor Settings: Alcatel-Lucent Login Method: Server-initiated - Change of authorization (RFC 3576) sent to controller. Logins Form: Credentials - Require a username and password Authentication: Anonymous allow a blank form requiring just the terms or a Log In button. A pre-existing account is required. </p>
<p>Example login</p>	 <p>The screenshot shows the guest login page for Alcatel-Lucent. The page title is 'Web Login'. The URL is 'https://10.255.95.250/guest/secure-access.php?bmac=40:67:a5:20b1:b8'. The page content includes: <ul style="list-style-type: none"> Alcatel-Lucent logo Please login to the network using your username and password. Username field: guest001@xyz.com Password field: [masked] Terms: <input checked="" type="checkbox"/> I accept the terms of use Log In button Footnote: * required field Contact a staff number if you are experiencing difficulty logging in. </p>

Verifying BYOD Configuration

A summary of the commands used for verifying the BYOD configuration is given here:

- | | |
|---------------------------------------|--|
| show unip global configuration | Displays global BYOD parameter values, such as the redirection server name, the port bounce status, and pause timer value. |
| show unip edge-user | Displays the status of the new BYOD clients that access the network. |

32 Configuring Application Monitoring and Enforcement

Application usage patterns in the enterprise network is changing with the increase in use of the social networking, browser based file sharing, and peer to peer applications. The use of these applications result in the new traffic patterns in the network that are not straightforward to distinguish.

OmniSwitch Application Monitoring and Enforcement (AppMon) feature addresses the key challenges of real time classification of flows at application level by providing differential QoS treatment in the form of higher priority marking and security policies at application level. AppMon feature improves the quality of user experience through application aware network optimization and control.

Application Enforcement feature allows the switch to differentiate between different traffic flows and assign the proper QoS and Security policies. The feature also provides appropriate QoS marking to applications flows as per the Application-aware user configuration QoS policies.

Application Monitoring feature collects and reports the application specific flow information over a period. Based on this data, application specific enforcement policies can be designed.

Note. AppMon is supported in a virtual chassis of OmniSwitch 6860 and OmniSwitch 6860E platforms where at least one OmniSwitch 6860E is mandatory for the feature to work.

In This Chapter

This chapter provides an overview of the AppMon feature and describes how to configure this feature through the Command Line Interface (CLI). CLI commands are used in the configuration examples; for more details about the syntax of commands, see the *OmniSwitch AOS Release 8 CLI Reference Guide*.

The following information and procedures are included in this chapter:

- [“AppMon Specifications” on page 32-3.](#)
- [“AppMon Defaults” on page 32-4.](#)
- [“Application Monitoring and Enforcement Overview” on page 32-5](#)
- [“Application Signature File/Kit” on page 32-9](#)
- [“Quick Steps for Configuring AppMon” on page 32-8.](#)
- [“Configuring AppMon” on page 32-11](#)
- [“Configuration Guidelines” on page 32-12](#)
- [“Verifying AppMon Configuration” on page 32-21.](#)

AppMon Specifications

AppMon feature is supported in a stack of OmniSwitch 6860 and OmniSwitch 6860E platforms where at least one OmniSwitch 6860E is mandatory for the feature to work.

Platforms supported	OmniSwitch 6860, 6860E
OmniSwitch Software License	AppMon supports the monitoring of a default signature set without a license. To extend support for additional application signatures, a license is required. For additional signature update information, refer to the OmniVista documentation.
Packet types sampled	TCP and UDP

AppMon Defaults

Description	Keyword	Default
AppMon default global status	app-mon admin-state	Disabled
AppMon default status on the physical port	app-mon port admin-state	Disabled
AppMon L3 mode	app-mon l3-mode	Enabled for both monitoring and enforcement (both Ipv4, Ipv6)
AppMon L4 mode	app-mon l4-mode	Enabled (both TCP and UDP)
AppMon flow-table enforcement statistics	app-mon flow-table enforcement stats	Disabled
Flow table aging interval (only Enforcement)	app-mon aging enforcement	Application specific
Logging threshold	app-mon logging-threshold	20000 flows
AppMon flow sync collection interval (only Enforcement)	app-mon flow-sync enforcement interval	60 seconds

Application Monitoring and Enforcement Overview

Application Monitoring and Enforcement (AppMon) feature is provided to address the key challenges of real time classification of flows at application level. It provides differential QoS treatment in the form of higher priority marking and security policies at application level. AppMon feature improves the quality of user experience through application aware network optimization and control.

The following are the key components for AppMon:

- Application Signature Kit File - the file containing application signatures.
- Application Pool - pool of supported applications.
- Application List - list of applications supported for monitoring or enforcement. Applications can be added to this list using the application name or application group.
- Application Group - a group of applications. The group can be added to the application list.
- QoS policy: QoS policy configuration at application level or application group level.

Application Monitoring

The following diagram provides a high-level example of Application Monitoring process:

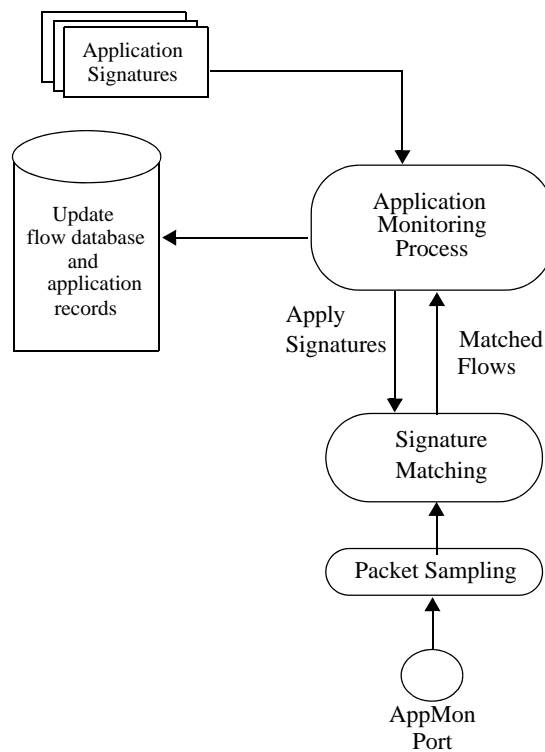

Application monitoring functionality includes:

- Identify traffic flows from attached networks at Layer 3.
- Application recognition of these traffic flows.
- Signature toolkit upgrade from OmniVista.
- Report the identified application flow information.
- Report application specific flow details including 5-tuple flow credentials, total number of flows, number of flows per application, and so on.

Application Enforcement

The following diagram provides a high-level example of Application Enforcement process:

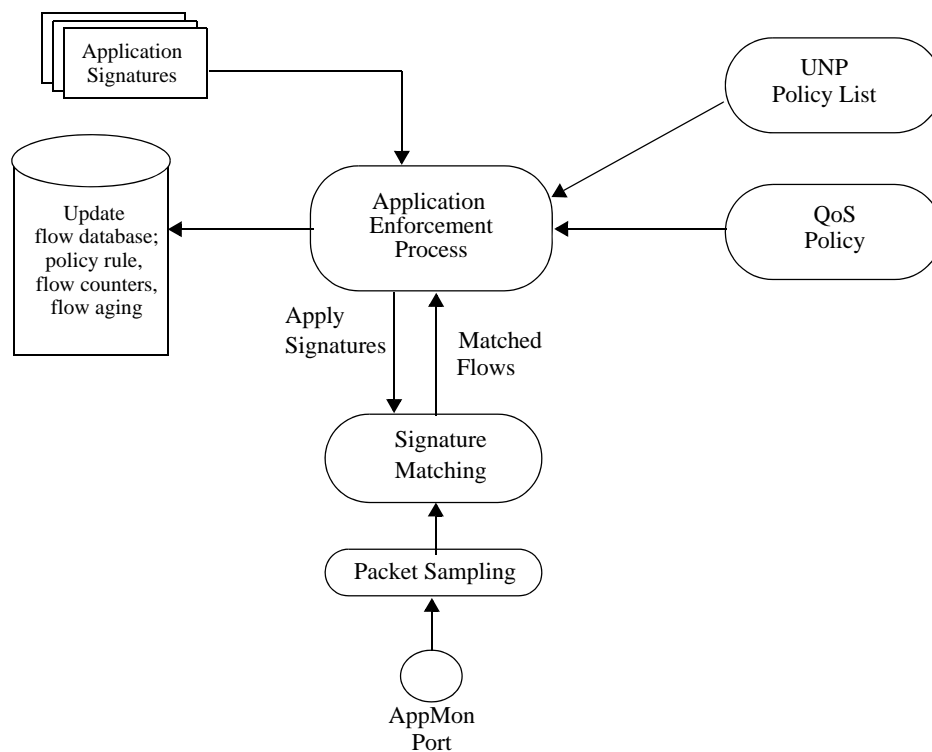

Application enforcement functionality includes:

- Identify traffic flows from attached networks at Layer 3.
- Application recognition of these traffic flows.
- Signature toolkit upgrade from OmniVista.
- Report the identified application flow information to CPU for UNP/VNP association.
- Policy enforcement that provides user configured application specific QoS treatment for application traffic flows including higher DSCP/802.1p or internal priority marking that translates to higher egress queue for traffic scheduling. QoS treatment can also include security policies that can perform policy action such as dropping or rate limiting the flows.

- Report application specific flow details including 5-tuple flow credentials, total number of flows, number of flows per application, and so on.
- Associate QoS policies with UNP profile and provide user level policy treatment. Main QoS policy action includes DSCP/802.1p/Priority Marking, Disposition drop/accept, and rate-limiter. Application flows may come with DSCP marking as found appropriate by the end device. Application enforcement feature overrides these values if QoS is configured, and marks them with values customized for network as per configuration.
- Display application information as part of per UNP user level.
- Existing QoS policy configuration framework is used for the enforcement policy configuration where application name/group can be specified. QoS policies provides treatment to bi-direction flow basis and not per uni-direction flow.

Quick Steps for Configuring AppMon

The following quick steps provide a brief tutorial for configuring AppMon on OmniSwitch.

- 1 Use the **app-mon admin-state** command to globally enable AppMon functionality on the switch.

```
-> app-mon admin-state enable
```

- 2 Use the **app-mon port admin-state** command to enable AppMon functionality on one or more switch ports. For example, the following command enables AppMon on ports 1/1/2 through 1/1/5:

```
-> app-mon port 1/1/2-5 admin-state enable
```

- 3 Add or remove applications or application groups to an application list for enforcement or monitoring using the **app-mon app-list** command. Separate application list is maintained for both enforcement and monitor features. For example:

```
-> app-mon app-list enforcement add app-name whatsapp
-> app-mon app-list monitor add app-group apg2
```

- 4 To enable the set of application signatures configured for AppMon, use the **app-mon apply** command. This activates both enforcement and monitoring application lists for flow classification.

```
-> app-mon apply
```

Note. Verify the AppMon configuration using the **show app-mon config** and **show app-mon port** commands. For example:

```
-> show app-mon config
Admin State                : Enable,
Operational State         : Enable,
L3-IPv4                    : Enable,
L3-IPv6                    : Enable,
Enforcement Flow-Table Stats : Enable,
Enforcement Flow-Sync Interval : 10 seconds,
Monitor Logging Threshold  : 20000,
Enforcement Logging Threshold : 20000,
App-Pool Applications      : 10,
Monitor Applied Applications : 10,
Enforcement Applied Applications : 10,
Upgraded Signature File Type : Factory,
AOS Compatible Signature Kit Version : 1,
Signature Kit version      : 1.1.1
```

```
-> show app-mon port
  Port      Admin-Status  Oper-Status  L4-mode
-----+-----+-----+-----
1/1/1      Enable           Up           TCP-UDP
1/1/2      Enable           Up           TCP-UDP
1/1/3      Enable           Up           TCP-UDP
1/1/4      Enable           Up           TCP-UDP
1/1/5      Enable           Up           TCP-UDP
1/1/6      Enable           Up           TCP-UDP
1/1/7      Enable           Up           TCP-UDP
.
```

See the *OmniSwitch AOS Release 8 CLI Reference Guide* for information about the fields in this display.

Application Signature File/Kit

Signatures are pattern recipes that are chosen for uniquely identifying an associated application (or protocol). When a new application or protocol is encountered, it is analyzed and an appropriate signature is developed and added to a database (referred to as a signature library).

Signature File Update

OmniSwitch boots up with the Factory Default Signature file. The application pool is created with the factory default kit. Other supported AppMon functionality, such as configuring application groups, configuring auto-application groups, adding to the application list, and so on, are user configurable.

- If there is any new default signature file present in the new AOS image, then AOS replaces the installed old default signature file with the new factory default signature file.
- OmniSwitch boots up with the factory default signature file. When the next signature file update is done through OmniVista (for more information, refer to OmniVista documentation), the new signature file is installed on top of the factory default file provided the required license is available. In case of license expiry or unavailability of license, switch continues to work with the existing signature file installed with valid license.
- On successful installation of the new signature file, the following actions take effect:
 - On every signature update, application pool will be recreated. The newly added applications are seen in the application pool.
 - If the 'auto-group create' option is used, 'category' based application groups will be created.
 - If the application group already exists, then all the auto-application groups will be updated with applications available in the newly updated application pool.
 - In case of application name missing in the new signature file: This will be treated as deleted application from the new application pool. Such applications are removed from the application pool, application group, application list, and active application list.
- Once the production signature file is installed, AOS does not roll back to the factory default signature file.
- AOS compatible signature file version determines the compatibility between AOS software and the Signature file. AOS maintains its own compatibility version and new signature file must have the same compatibility version to successfully update on AOS. This must remain same for both. Switch allows the signature file upgrade only when the compatibility version between AOS and the signature file match.
- In case of application added application name missing in the new signature file: This will be treated as deleted application from the new application pool. Such applications are removed from application pool, application groups, application list, and active application list. The newly added applications are seen in the application pool.

Application Flow Database

When a match occurs between IP traffic and the application signature, a flow entry is created based on the following 5-tuple:

- Source IP Address (IPv4 or IPv6)
- Destination IP Address (IPv4 or IPv6)
- Source L4 port
- Destination L4 port
- IP Protocol (TCP or UDP)

Configuring AppMon

This section provides the following information about how to configure AppMon on the OmniSwitch:

- [“Configuration Guidelines” on page 32-12.](#)
- [“Enabling/Disabling AppMon” on page 32-14.](#)
- [“Enabling/Disabling AppMon Per Port or Slot” on page 32-14](#)
- [“Create Auto-Groups” on page 32-15](#)
- [“Configuring Application Group” on page 32-15.](#)
- [“Configuring Application List” on page 32-16.](#)
- [“Activate Applications for AppMon” on page 32-16](#)
- [“Configuring L3 Mode of Operation” on page 32-17](#)
- [“Configuring L4 Mode of Operation” on page 32-17](#)
- [“Clearing Flow Table Entries” on page 32-18](#)
- [“Configuring Flow Table Statistics Update” on page 32-18](#)
- [“Configuring Aging Interval” on page 32-18](#)
- [“Configuring Logging Threshold” on page 32-19](#)
- [“Configuring Sync Interval” on page 32-19](#)
- [“Configuring Force Flow Sync” on page 32-19](#)
- [“Clearing Application List” on page 32-20](#)
- [“Configuring AppMon Enforcement QoS Policy Rules” on page 32-20](#)

Configuration Guidelines

Review the guidelines in this section before configuring AppMon on the OmniSwitch.

- AppMon works on an application level and not on individual application events/operations. On configuring an application, all associated events are considered for application monitoring and enforcement.
- Supports only IP traffic (TCP or UDP).
- AppMon must not be configured on user ports and uplink ports at the same time.
- AppMon does not support link aggregate interface. AppMon is supported at individual port level only. Also, port will not be allowed to be configured in the link aggregate if AppMon is enabled on the port.
- Does not support tunneled traffic, encrypted traffic, and fragmented traffic (supported only if initial fragmented packet contains the signature).
- Software policy lookup considers AppMon enforcement specific policies for a given application name only when it is part of an active application list. In case of policy configured both for application and application group where same application is part, policy will be selected based on what is configured in the active application list. Active application list allows only one application at a time, either directly added in the application list or added through an application group.
- Application enforcement cannot be provided to IP flows which moves between NIs (due to link aggregate, STP block scenario, or L3 ECMP group configuration).
- If an AppMon flow is detected on a UNP port, then AppMon UNP policy list is applied to the flow. If UNP policy list is not configured, then default QoS policy list is applied. For non-UNP ports, default QoS policy list is applied. The [show unip edge-user details](#) command displays the list of enforcement applications used by the UNP user. For example:

```
-> show unip edge-user details
Port: 4/1/6
MAC-Address: 00:80:9f:a0:65:94
  Access Timestamp           = 02/18/2014 04:42:33,
  User Name                  = 00:80:9f:a0:65:94,
  IP-Address                 = 25.1.1.25,
  Vlan                       = 25,
  Authentication Type        = Mac,
  Authentication Status      = Authenticated,
  Authentication Failure Reason = -,
  Authentication Retry Count = 0,
  Authentication Server IP Used = 135.254.163.143,
  Authentication Server Used  = cppm,
  Server Reply-Message       = -,
  Profile                    = UNP-device,
  Profile Source              = Auth - Pass - Server UNP,
  Profile From Auth Server    = UNP-device,
  Classification Profile Rule = -,
  Role                        = pl3,
  Role Source                 = L2-Profile,
  User Role Rule              = -,
  Restricted Access           = No,
  Location Policy Status      = -,
  Time Policy Status          = -,
  Captive-Portal Status       = -,
  QMR Status                  = Passed,
  Redirect Url                = -,
```

```
SIP Call Type           = Not in a call,  
SIP Media Type         = None,  
Applications         = whatsapp  
Total users : 1
```

- For QoS policies, AppMon can be enabled on any OmniSwitch 6860 or OmniSwitch 6860E element of the network for enforcing policy actions such as drop, 802.1p/DSCP priority marking, and rate limiting. Only the edge switches need to enable AppMon enforcement functionality for higher priority QoS treatment. Intermediate switches in the network must only provide consistent QoS treatment based on the earlier marking done by edge switches, whereas core switches only provide QoS treatment.
- AppMon enforcement configures both ingress/egress flow tracking configuration on each port when enabled. If both ports are disabled for a given flow, flow is not tracked and QoS treatment is not given.
- To upgrade an OmniSwitch from an 8.1.1 image to an 8.2.1 image, remove the existing AppMon configuration and use the **write memory** command. After a successful upload of an 8.2.1 image, configure the required AppMon settings.

Enabling/Disabling AppMon

To enable AppMon feature globally on the switch, use the **app-mon admin-state** command with the **enable** option. By default, AppMon is disabled on the switch.

```
-> app-mon admin-state enable
```

To disable AppMon functionality, use the **app-mon admin-state** command with the **disable** option.

```
-> app-mon admin-state disable
```

Note. AppMon cannot be enabled globally when,

- all the mirroring sessions are used by port mirroring or monitoring features.
 - mirroring session is used by policy manager.
-

Enabling/Disabling AppMon Per Port or Slot

To enable AppMon on one or more switch ports, use the **app-mon port admin-state** command with **enable** option as shown. It is mandatory to enable AppMon globally for the port level AppMon to function. By default, AppMon is disabled on all the switch ports.

For example, the following command enables AppMon on ports 1/1/2 through 1/1/5:

```
-> app-mon port 1/1/2-5 admin-state enable
```

For example, the following command enables AppMon on slot 1.

```
-> app-mon slot 1/1 admin-state enable
```

When slot option is used, then AppMon configuration is applied on all physical ports of that particular slot.

To disable AppMon functionality on a port or slot, use the **app-mon port admin-state** command with **disable** option. For example:

```
-> app-mon port 1/1/2-5 admin-state disable  
-> app-mon slot 1/1 admin-state disable
```

Create Auto-Groups

Auto-Group functionality automatically creates application-groups based on the classification of supported applications in the signature file. The ‘Category’ field is used for classification (for example, Youtube will be part of Web category, and Webex will be part of Audio/Video category).

To create application groups automatically on the switch, use the **app-mon auto-group create** command.

```
-> app-mon auto-group create
```

On using the **app-mon auto-group create** command, the following action will be taken:

- Category-based application groups are created. If the application group already exist with category names, those groups are updated from the existing application pool. Application group update includes addition of all the applications of a given category from the application pool to the corresponding auto-application group. The auto-application group retains any additional applications added by the user.
- Modifications are allowed in auto-application groups with addition of applications using the **app-mon app-group** command. Deletion of applications is also allowed for any application in the group. Modifications to the auto-application groups are retained on reboot, if saved by using the **appapp-mon apply** and **write memory** commands.
- On signature file update, if the “auto-group create” option is given, category-based application groups are created or updated if they already exist.
- It is mandatory to enter **appapp-mon apply** to save the auto-group configuration on the switch.

Configuring Application Group

Applications can be added to an application group. To create an application group, use the **app-mon app-group** command. You can add individual applications or a range of applications to an application group. Only those applications that are part of an application pool are allowed to be added to an application group. This group can be used for enforcement or to monitor features.

To add a specific application to an application group, use the following command:

```
-> app-mon app-group apg2 add app-name whatsapp
```

To add a range of applications or multiple applications to an application group, use the **from** and **to** options.

```
-> app-mon app-group apg1 add from sip to viber
```

To remove an application from an application group, use the following command:

```
-> app-mon app-group apg2 remove app-name whatsapp
```

Configuring Application List

Configure an application list for enforcement or monitoring. The list can be formed with individual applications or with application groups. A separate application list is maintained for both enforcement and monitor features.

To add or remove application or application group to an application list, use the **app-mon app-list** command. You can add individual application or an application group to an application list. The application group can be user created or generated automatically (see [“Create Auto-Groups” on page 32-15](#) and [“Configuring Application Group” on page 32-15](#)).

For example, the following command adds an individual application to the application list.

```
-> app-mon app-list add app-name whatsapp
```

For example, the following example adds an application group to the application list. Application group enables addition of multiple applications to the application list.

```
-> app-mon app-list add app-group apg1
```

To remove an application from an application list, use the following command. For example:

```
-> app-mon app-list remove app-name whatsapp
```

Activate Applications for AppMon

To enable the set of application signatures configured for both enforcement and monitoring application lists for flow classification, use the **app-mon apply** command. This command activates the application list configuration. This command saves the current application-list, application-group, and auto-groups configuration to flash when the **write memory** command is used.

```
-> app-mon apply
```

When **app-mon apply** command is used, any application configured more than once in an application list (individually or as a part of application group) is checked. The **app-mon apply** command will not be successful until the conflict is resolved. Use the **show app-mon app-list** command with the **monitor conflict** or the **enforcement conflict** parameter option to display the available conflicts in an application list. The duplicate application names must be removed for successful **app-mon apply**.

Configuring L3 Mode of Operation

To enable or disable monitoring and enforcement for IPv4 flows, IPv6 flows, or both, use the [app-mon l3-mode](#) command. By default, monitoring and enforcement is enabled for both IPv4 and IPv6 flows.

For example, the following command enables monitoring and enforcement for IPv4 packets:

```
-> app-mon l3-mode ipv4 admin-state enable
```

The following command disables monitoring and enforcement for IPv4 packets:

```
-> app-mon l3-mode ipv4 admin-state disable
```

Configuring L4 Mode of Operation

To enable or disable monitoring and enforcement for TCP or UDP flows, use the [app-mon l4-mode](#) command. By default, both TCP and UDP flows are processed. For example:

The following command enables monitoring and enforcement for UDP flows:

```
-> app-mon port 1/1/2 l4-mode udp admin-state enable
```

The following command disables monitoring and enforcement for UDP flows:

```
-> app-mon port 1/1/2 l4-mode udp admin-state disable
```

A specific L4 port range can be excluded from the AppMon operation using the [app-mon l4port-exclude](#) command. The valid Exclude ID range is 1–8. The valid port range is 1–65535.

For example, to exclude TCP port 20 to port 30 from the AppMon operation, use the following command:

```
-> app-mon l4port-exclude range-id 5 tcp-service-port start 20 end 30
```

Use the **no** form of the [app-mon l4port-exclude](#) command to delete the range. For example,

```
-> no app-mon l4port-exclude range-id 6
```

Clearing Flow Table Entries

To clear all the learned flow-table entries from the monitor or enforcement application list, use the **app-mon flow-table flush** command. For example:

```
-> app-mon flow-table enforcement flush
-> app-mon flow-table monitor flush
```

Configuring Flow Table Statistics Update

To enable or disable flow table statistics update for enforcement applications, use the **app-mon flow-table enforcement stats** command. This command is applicable only for enforcement applications.

The statistics collection capability is shared with the Service Manager feature, which means that either Service Manager or AppMon can use this capability at any given time. Hence, disabling the counter usage by Service manager using the **service stats** command is required to view the flow table statistics update for enforcement applications. For more information about this command, see the “Service Manager Commands” chapter in the *OmniSwitch AOS Release 8 CLI Reference Guide*.

The following command enables flow-table statistics update for enforcement applications:

```
-> app-mon flow-table enforcement stats admin-state enable
```

The following command disables flow-table statistics update for enforcement applications:

```
-> app-mon flow-table enforcement stats admin-state disable
```

Configuring Aging Interval

Configures aging time for dynamically learned TCP/UDP flows for each application for Enforcement applications.

Flow aging is supported for the applications that are part of the enforcement application list. Flows related with enforcement application list are made active for QoS treatment as well statistics collection. Flow aging is not supported for applications that are part of Monitor application list. Monitor flow tables log these flows when they are detected until logging threshold is reached.

The aging interval time can be specified in the range of 3–120 minutes. By default, the aging interval is set per application and TCP or UDP flow type basis. TCP and UDP flows generated by a given application age out based on the TCP/UDP configured value.

To configure the aging interval, use the **app-mon aging enforcement** command. For example:

```
-> app-mon aging enforcement app-name sip interval 60m
```

To configure the default aging interval, use the **default** keyword. For example:

```
-> app-mon aging enforcement app-name tftp default
```

Configuring Logging Threshold

To configure the threshold value for the number of matched flows for enforcement and monitor applications, use the **app-mon logging-threshold** command.

The maximum number of flows to be logged is in the range of 1000–60000 flows. When the logging threshold value is set to '0', flows are not logged to the log file.

When used with the monitor option, the threshold is configured for the number of matched flows to be displayed in the monitor flow table commands. For example, the following command configures a threshold value of 10000 for monitor applications.

```
-> app-mon logging-threshold monitor num-of-flows 10000
```

When used with the enforcement option, the threshold is configured for the number of matched flows to be saved on to the log file for enforcement applications. For example, the following command configures a threshold value of 30000 for enforcement applications.

```
-> app-mon logging-threshold enforcement num-of-flows 30000
```

To configure the default logging threshold, 20000, use the **default** keyword as shown.

```
-> app-mon logging-threshold monitor num-of-flows default
```

Configuring Sync Interval

Configures the interval at which the enforcement flows information is refreshed. The range for the interval is 10–3600 seconds. The interval can be configured only for the enforcement feature.

Use the **app-mon flow-sync enforcement interval** command to force the flow sync. For example:

```
-> app-mon flow-sync enforcement interval 10
```

To configure the default interval value, 60 seconds, use the **default** keyword as shown.

```
-> app-mon flow-sync enforcement interval default
```

Default flow-sync interval is 300 seconds for monitoring. This is not user configurable.

Configuring Force Flow Sync

To synchronize the flows learned in the data path in real time, use the **app-mon force-flow-sync** command. By default, flow synchronization occurs every 5 minutes for monitor flows and 60 seconds for enforcement flows.

For example:

```
-> app-mon force-flow-sync enforcement
-> app-mon force-flow-sync monitor
```

Clearing Application List

To remove all the applications from the enforcement or monitor application list, use the **clear app-mon app-list** command. This command does not clear the active application list, until 'app-mon apply' is used.

For example:

```
-> clear app-mon app-list enforcement
-> clear app-mon app-list monitor
```

Configuring AppMon Enforcement QoS Policy Rules

AppMon enforcement allows the switch to differentiate between different traffic flows and assign the proper QoS and Security policies. The following set of policy actions are supported: Disposition Drop/Accept, Rate limiting, DSCP Marking, 802.1p Marking, Internal Priority Marking, Redirection, and Mirroring.

- QoS policy rules can be configured for a given application as well as an application group where the same application also exists. The QoS policy applied is based on what is configured in the application list at the time of **app-mon apply**.
- QoS policy lookup considers AppMon specific policies for a given application name only when it is part of enforcement active application list. In case the policy is configured both for application name and application group where same application is part, policy will be selected based on what is configured in the enforcement active application list.
- QoS policy lookup is performed for the flow when AppMon signature matched packet is received. If there is any change to existing QoS policies, modified policies are effective only for the new flows. However, the following scenarios are supported:
 - If there is a change in policy action, existing matched flows are updated for new policy action.
 - If AppMon specific policy rules are removed, flows to which the rules were applied are moved to the default policy.
 - On QoS disable, existing flows are moved to the default policy.
 - On QoS flush or apply, existing flows are moved to the default policy.
 - Default policy refers to disposition accept policy action.
- While configuring an AppMon policy rule, multiple condition parameters (for example, source IP, destination IP, source VLAN and so on) cannot be defined in a single policy condition along with AppMon application name or group.
- The application group needs to be created before adding the application group in QoS policies.
- While configuring the QoS policies, the application name or the application group must exist in AppMon.
- Destination port or port group based policy condition is not supported for AppMon.

Configure AppMon enforcement QoS policy rules using the **policy condition** command. An application name or application-group name can be specified in the policy condition as shown below.

```
-> policy condition c1 app-mon-application-group appgroup1
-> policy condition c2 app-mon-application-name whatsapp
```

For more information about configuring QoS policy rules for AppMon, see the “QoS Policy Commands” chapter in the *OmniSwitch AOS Release 8 CLI Reference Guide* and the [Chapter 27, “Configuring QoS.”](#) chapter in this guide.

Verifying AppMon Configuration

A summary of the **show** commands used for verifying the AppMon configuration is given here.

show app-mon config	Displays global AppMon configuration, which includes information about admin-state, running mode, IP mode, aging-timer, and total signatures.
show app-mon port	Displays AppMon status per physical port or per slot for the switch.
show app-mon app-pool	Displays all the applications that are part of an application pool.
show app-mon app-list	Displays a list of applications and application groups added to an application list.
show app-mon app-group	Displays the details of all the applications in an application group.
show app-mon app-record	Displays current-hour application-record information as well the historic application-records on the hourly or 24-hours basis for monitored applications.
show app-mon ipv4-flow-table	Displays the flow table for IPv4 flows entries for enforcement and monitor flows.
show app-mon ipv6-flow-table	Displays the flow table for IPv6 flows entries for enforcement and monitor flows.
show app-mon l4port-exclude	Displays the port range excluded from AppMon operation.
show app-mon stats	Displays the number of flow statistics.
show app-mon aging enforcement	Displays the aging interval for each application for enforcement feature.
show app-mon vc-topology	Displays the AppMon VC topology.

33 Configuring Port Mapping

Port Mapping is a security feature that controls communication between peer users. Each session comprises of a session ID, a set of user ports, and/or a set of network ports. The user ports within a session cannot communicate with each other and can only communicate through network ports. In a port mapping session with user port set A and network port set B, the ports in set A can only communicate with the ports in set B. If set B is empty, the ports in set A can communicate with rest of the ports in the system.

A port mapping session can be configured in the unidirectional or bidirectional mode. In the unidirectional mode, the network ports can communicate with each other within the session. In the bidirectional mode, the network ports cannot communicate with each other. Network ports of a unidirectional port mapping session can be shared with other unidirectional sessions, but cannot be shared with any sessions configured in the bidirectional mode. Network ports of different sessions can communicate with each other.

In This Chapter

This chapter describes the port mapping security feature and explains how to configure the same through the Command Line Interface (CLI).

Configuration procedures described in this chapter include:

- [Creating/Deleting a Port Mapping Session](#)—see [“Creating a Port Mapping Session”](#) on page 33-4 or [“Deleting a Port Mapping Session”](#) on page 33-4.
- [Enabling/Disabling a Port Mapping Session](#)—see [“Enabling a Port Mapping Session”](#) on page 33-5 or [“Disabling a Port Mapping Session”](#) on page 33-5.
- [Configuring a Port Mapping Direction](#)—see [“Configuring Unidirectional Port Mapping”](#) on page 33-5 and [“Restoring Bidirectional Port Mapping”](#) on page 33-5.
- [Configuring an example Port Mapping Session](#)—see [“Sample Port Mapping Configuration”](#) on page 33-6.
- [Verifying a Port Mapping Session](#)—see [“Verifying the Port Mapping Configuration”](#) on page 33-7.

Port Mapping Specifications

Platforms Supported	OmniSwitch 6860, 6860E
Ports Supported	Ethernet (10 Mbps) Fast Ethernet (100 Mbps) Gigabit Ethernet (1 Gbps) 10 Gigabit Ethernet (10 Gbps)
Port Mapping Sessions	8

Port Mapping Defaults

The following table shows port mapping default values.

Parameter Description	CLI Command	Default Value/Comments
Mapping Session Creation	<code>port-mapping user-port network-port</code>	No mapping sessions
Mapping Status configuration	<code>port-mapping</code>	Disabled
Port Mapping Direction	<code>port-mapping [unidirectional bidirectional]</code>	Bidirectional
Port Mapping Unknown Unicast Flooding	<code>port-mapping unknown-unicast-flooding</code>	Enabled

Quick Steps for Configuring Port Mapping

Follow the steps below for a quick tutorial on configuring port mapping sessions. Additional information on how to configure each command is given in the subsections that follow.

1 Create a port mapping session with the user ports, network ports, or both user ports and network ports with the **port-mapping user-port network-port** command. For example:

```
-> port-mapping 8 user-port 1/1/2 network-port 1/1/3
```

2 Enable the port mapping session with the **port-mapping** command. For example:

```
-> port-mapping 8 enable
```

Note. You can verify the configuration of the port mapping session by entering **show port-mapping** followed by the session ID.

```
-> show port-mapping 8
```

```
SessionID      USR-PORT      NETWORK-PORT
-----+-----+-----
           8             1/1/2             1/1/3
```

You can also verify the status of a port mapping session by using the **show port-mapping status** command.

Creating/Deleting a Port Mapping Session

Before port mapping can be used, it is necessary to create a port mapping session. The following subsections describe how to create and delete a port mapping session with the **port-mapping user-port network-port** and **port-mapping** command, respectively.

Creating a Port Mapping Session

To create a port mapping session either with the user ports, network ports, or both the user ports and network ports, use the **port-mapping user-port network-port** command. For example:

```
-> port-mapping 8 user-port 1/1/2-5 network-port 1/2/3
```

You can create a port mapping session with link aggregate network ports. For example:

```
-> port-mapping 3 network-port linkagg 7
-> port-mapping 3 network-port linkagg 8
-> port-mapping 3 network-port linkagg 9
```

You can specify all the ports of a slot to be assigned to a mapping session. For example, to create a port mapping session 3 with all the ports of slot 1 as network ports, enter:

```
-> port-mapping 3 network-port slot 1/1
```

You can specify a range of ports to be assigned to a mapping session. For example, to create a port mapping session 4 with ports 5 through 8 as user ports, enter:

```
-> port-mapping 4 user-port 1/1/5-8
```

Deleting a User/Network Port of a Session

To delete a user/network port of a port mapping session, use the **no** form of the **port-mapping user-port network-port** command. For example:

```
-> no port-mapping 8 user-port 1/1/3
```

Similarly, to delete the network ports of link aggregation group 7, enter:

```
-> no port-mapping 4 network-port linkagg 7
```

Deleting a Port Mapping Session

To delete a previously created mapping session, use the **no** form of the **port-mapping** command. For example, to delete the port mapping session 6, enter:

```
-> no port-mapping 6
```

Enabling/Disabling a Port Mapping Session

By default, the port mapping session is disabled. The following subsections describe how to enable and disable the port mapping session with the **port-mapping** command.

Enabling a Port Mapping Session

To enable a port mapping session, enter **port-mapping** followed by the session ID and **enable**. For example, to enable the port mapping session 5, enter:

```
-> port-mapping 5 enable
```

Disabling a Port Mapping Session

To disable a port mapping session, enter **port-mapping** followed by the session ID and **disable**. For example, to disable the port mapping session 5, enter:

```
-> port-mapping 5 disable
```

Disabling the Flooding of Unknown Unicast Traffic

By default, unknown unicast traffic is flooded to the user ports of a port mapping session from all the switch ports. To disable this flooding and to receive traffic from only the network ports, enter:

```
-> port-mapping 5 unknown-unicast-flooding disable
```

Configuring a Port Mapping Direction

By default, port mapping sessions are bidirectional. The following subsections describe how to configure and restore the directional mode of a port mapping session with the **port-mapping [unidirectional | bidirectional]** command.

Configuring Unidirectional Port Mapping

To configure a unidirectional port mapping session, enter **port-mapping** followed by the session ID and **unidirectional** keyword. For example, to configure the direction of a port mapping session 6 as unidirectional, enter:

```
-> port-mapping 6 unidirectional
```

Restoring Bidirectional Port Mapping

To restore the direction of a port mapping session to its default (bidirectional), enter **port-mapping** followed by the session ID and **bidirectional** keyword. For example, to restore the direction (bidirectional) of the port mapping session 5, enter:

```
-> port-mapping 5 bidirectional
```

Note. To change the direction of an active session with network ports, delete the network ports of the session, change the direction, and recreate the network ports.

Sample Port Mapping Configuration

This section provides an example port mapping network configuration. In addition, a tutorial is also included that provides steps on how to configure the example port mapping session using the Command Line Interface (CLI).

Example Port Mapping Overview

The following diagram shows a four-switch network configuration with active port mapping sessions. In the network diagram, the Switch A is configured as follows:

- Port mapping session 1 is created with user ports 2/1/1, 2/1/2 and network ports 1/1/1, 1/1/2 and is configured in the unidirectional mode.
- Port mapping session 2 is created with user ports 3/1/1, 3/1/2, and 3/1/3 and network port 1/1/3.

The Switch D is configured by creating a port mapping session 1 with user ports 2/1, 2/2 and network ports 1/1/1.

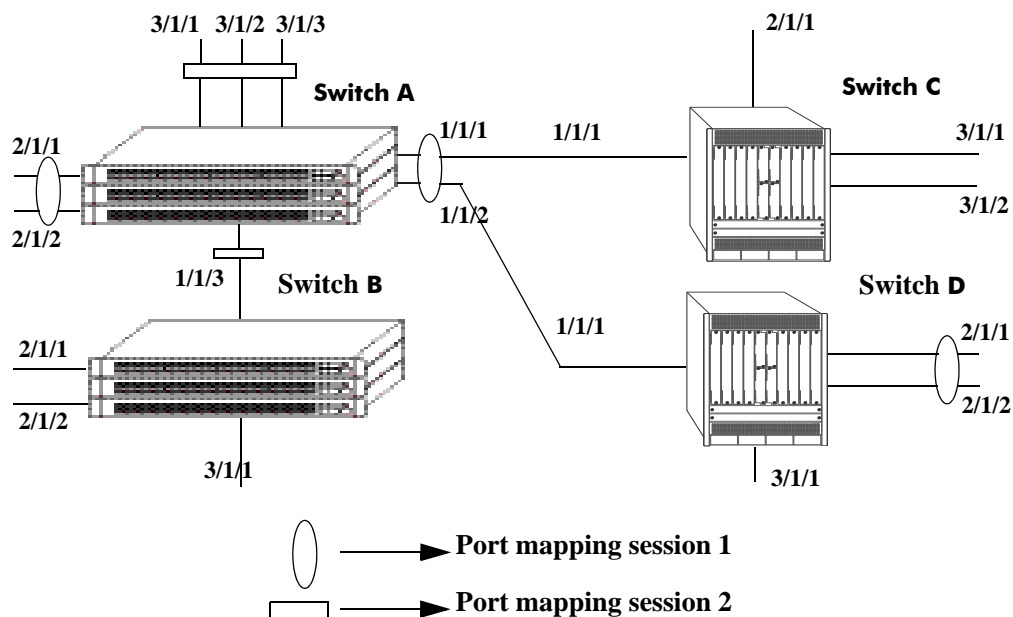

Example Port Mapping Topology

In the above example topology:

- Ports 2/1/1 and 2/1/2 on Switch A do not interact with each other and do not interact with the ports on Switch B.
- Ports 2/1/1, 2/1/2, and 3/1/1 on Switch B interact with all the ports of the network except with ports 2/1/1 and 2/1/2 on Switch A.
- Ports 2/1/1 and 2/1/2 on Switch D do not interact with each other but they interact with all the user ports on Switch A except 3/1/1, 3/1/2, and 3/1/3. They also interact with all the ports on Switch B and Switch C.
- Ports 3/1/1, 3/1/2, and 2/1/1 on Switch C can interact with all the user ports on the network except 3/1/1, 3/1/2, and 3/1/3 on Switch A.

Example Port Mapping Configuration Steps

The following steps provide a quick tutorial to configure the port mapping session shown in the diagram on [page 33-6](#).

- 1 Configure session 1 on Switch A in the unidirectional mode using the following command:

```
-> port-mapping 1 unidirectional
```

- 2 Create two port mapping sessions on Switch A using the following commands:

```
-> port-mapping 1 user-port 2/1/1-2 network-port 1/1/1-2  
-> port-mapping 2 user-port 3/1/1-3 network-port 1/1/3
```

- 3 Enable both the sessions on Switch A using the following commands:

```
-> port-mapping 1 enable  
-> port-mapping 2 enable
```

- 4 Similarly, create and enable a port mapping session 1 on Switch D using the following commands:

```
-> port-mapping 1 user-port 2/1/1-2 network-port 1/1/1  
-> port-mapping 1 enable
```

Verifying the Port Mapping Configuration

To display information about the port mapping configuration on the switch, use the show commands listed below:

- | | |
|---------------------------------|--|
| show port-mapping status | Displays the status of one or more port mapping sessions. |
| show port-mapping | Displays the configuration of one or more port mapping sessions. |

For more information about the displays that result from these commands, see the *OmniSwitch AOS Release 8 CLI Reference Guide*.

34 Configuring Learned Port Security

Learned Port Security (LPS) provides a mechanism for authorizing source learning of MAC addresses on Ethernet ports. The only types of Ethernet ports that LPS does not support are link aggregate and 802.1Q trunked link aggregate ports. Using LPS to control source MAC address learning provides the following benefits:

- A configurable source learning time limit that applies to all LPS ports.
- A configurable limit on the number of MAC addresses (bridged and filtered) allowed on an LPS port.
- Dynamic configuration of a list of authorized source MAC addresses.
- Static configuration of a list of authorized source MAC addresses.
- Three methods for handling unauthorized traffic: administratively disable the LPS port, stop all traffic on the port(port remains up), or only block traffic that violates LPS criteria.

In This Chapter

This chapter provides an overview of the LPS feature and describes how to configure LPS parameters through the Command Line Interface (CLI). CLI commands are used in the configuration examples; for more details about the syntax of commands, see the *OmniSwitch AOS Release 8 CLI Reference Guide*.

The following information and procedures are included in this chapter:

- [“Learned Port Security Specifications” on page 34-2.](#)
- [“Learned Port Security Defaults” on page 34-2.](#)
- [“Sample Learned Port Security Configuration” on page 34-3.](#)
- [“Learned Port Security Overview” on page 34-5.](#)
- [“Interaction With Other Features” on page 34-10.](#)
- [“Configuring Learned Port Security” on page 34-11.](#)
- [“Displaying Learned Port Security Information” on page 34-20.](#)

For more information about source MAC address learning, see [Chapter 3, “Managing Source Learning.”](#)

Learned Port Security Specifications

Platforms Supported	OmniSwitch 6860, 6860E
Ports eligible for Learned Port Security	Fixed and 802.1Q tagged
Ports not eligible for Learned Port Security	Link aggregate ports. 802.1Q (trunked) link aggregate ports.
Minimum number of learned MAC addresses allowed per LPS port	1
Maximum number of learned MAC addresses allowed per LPS port	1000
Maximum number of filtered MAC addresses allowed per LPS port	100
Maximum number of configurable MAC address ranges per LPS port	1

Learned Port Security Defaults

Parameter Description	Command	Default
LPS status for a port.	port-security	disabled
Number of learned MAC addresses allowed on an LPS port.	port-security maximum	1
Maximum number of filtered MAC addresses that the LPS port can learn.	port-security port max-filtering	5
Source learning time limit.	port-security learning-window	infinity
MAC address range per LPS port.	port-security mac-range	00:00:00:00:00:00– ff:ff:ff:ff:ff:ff
LPS port violation mode.	port-security port violation	restrict
Number of bridged MAC addresses learned before a trap is sent.	port-security learn-trap-threshold	5

Sample Learned Port Security Configuration

This section provides a quick tutorial to perform the following tasks:

- Enabling LPS on a set of switch ports.
- Defining the maximum number of learned MAC addresses allowed on an LPS port.
- Defining the time limit for which source learning is allowed on all LPS ports.
- Selecting a method for handling unauthorized traffic received on an LPS port.

Quick Steps

1 Enable LPS on ports 6 through 8 using the following commands:

```
-> port-security port 1/1/6-8 admin-state enable
```

2 Set the total number of learned MAC addresses allowed on the same ports to 25 using the following command:

```
-> port-security port 1/1/6-8 maximum 25
```

3 Configure the amount of time in which source learning is allowed on all LPS ports to 30 minutes using the following command:

```
-> port-security learning-window 30
```

4 Select **shutdown** for the LPS violation mode using the following command:

```
-> port-security port 1/1/6-8 violation shutdown
```

Note. *Optional.* To verify LPS port configurations, use the command [show port-security](#). For example:

```
-> show port-security port 1/1/1
Port: 1/1/1
Admin-State      :          ENABLED,
Operation Mode   :          ENABLED,
Max MAC bridged  :          3,
Trap Threshold   :          1,
Violation        :          RESTRICT
Max MAC filtered :          5,
Low MAC Range    :          00:00:00:00:00:00,
High MAC Range   :          ff:ff:ff:ff:ff:ff,
Violating MAC    :          NULL
```

MAC	VLAN	MAC TYPE	OPERATION
00:11:22:22:22:22	1	STATIC	bridging
00:11:22:22:22:21	1	STATIC	bridging
00:11:22:22:22:21	1	PSEUDO-STATIC	bridging

To verify the new source learning time limit value, use the [show port-security learning-window](#) command. For example:

```
-> show port-security learning-window
Learning-Window           = 500 min,
Convert-to-static         = DISABLE,
No Aging                  = ENABLE,
Boot Up                   = ENABLE,
Remaining Learning Window = 25018 sec
Learn As Static           = ENABLE,
Mac Move                  = ENABLE,
```

Learned Port Security Overview

Learned Port Security (LPS) provides a mechanism for controlling network device access on one or more switch ports. Configurable LPS parameters allow the user to restrict the source learning of host MAC addresses to:

- A specific amount of time in during which source learning is allowed to occur on all LPS ports.
- A maximum number of learned MAC addresses allowed on the port.
- A maximum number of filtered MAC addresses allowed on the port.
- A range of authorized source MAC addresses allowed on the port.

Additional LPS functionality allows the user to specify how the LPS port handles unauthorized traffic. The following options are available for this purpose:

- Block traffic that violates LPS port restrictions; authorized traffic is forwarded on the port.
- Disable learning on the LPS port when unauthorized traffic is received.
- Administratively down the LPS port when unauthorized traffic is received; all traffic is stopped.

LPS functionality is supported on the following port types:

- Fixed
- 802.1Q tagged
- Universal Network Profile (UNP).

The following port types are not supported:

- Link aggregate
- Tagged (trunked) link aggregate
- Link aggregate members

LPS Learning Window

The LPS learning window is a configurable amount of time during which source learning of MAC addresses is allowed on LPS ports. This time limit is a global switch value that applies to all LPS-enabled ports; it is not configurable on an individual port basis.

In addition to the source learning time limit, the following learning window options are configurable:

- **Convert dynamically learned MAC addresses to static MAC addresses.** When this option is enabled, all dynamic MAC addresses learned during the learning window time period are converted to static MAC addresses when the learning window closes.
- **Start the learning window when the switch boots up.** When this option is enabled, the learning window time period automatically starts each time the switch restarts.
- **Stop dynamically learned MAC address aging.** When this option is enabled, MAC addresses learned during the learning window time period are learned as pseudo-static MAC addresses. This type of address does not age out or get flushed even after the learning window closes.

- **Allow MAC movement.** When this option is enabled, a pseudo-static MAC address learned on one port can move to another port in the same VLAN without getting dropped.
- **Automatically learn MAC addresses as static MAC addresses.** When this option is enabled, learned MAC addresses are automatically converted to static MAC addresses during the learning window time.

MAC Address Types

There are four types of MAC addresses that are the result of or involved with the LPS port configuration and operation:

- **Static.** A user-configured MAC address on the LPS port.
- **Pseudo Static.** A dynamically learned MAC address that is treated the same as a regular static address (will not age out). However, pseudo-static MAC addresses are not saved in the running configuration of the switch.
- **Dynamic Bridged.** MAC address that are dynamically learned as bridged addresses up to the maximum number of bridged addresses allowed on the LPS port. When this maximum is reached, subsequent addresses are dynamically learned as filtered MAC addresses.
- **Dynamic Filtered.** MAC addresses that are dynamically learned as filtered address up to the maximum number of filtered addresses allowed on the LPS port.

How LPS Authorizes Source MAC Addresses

When a packet is received on a port that has LPS enabled, switch software checks specific criteria to determine if the source MAC address contained in the packet is allowed on the port. The following chart depicts the flow of the MAC address as various LPS rules are applied to determine whether or not the address is learned on the port and the state of the address on that port (bridged or filtered):

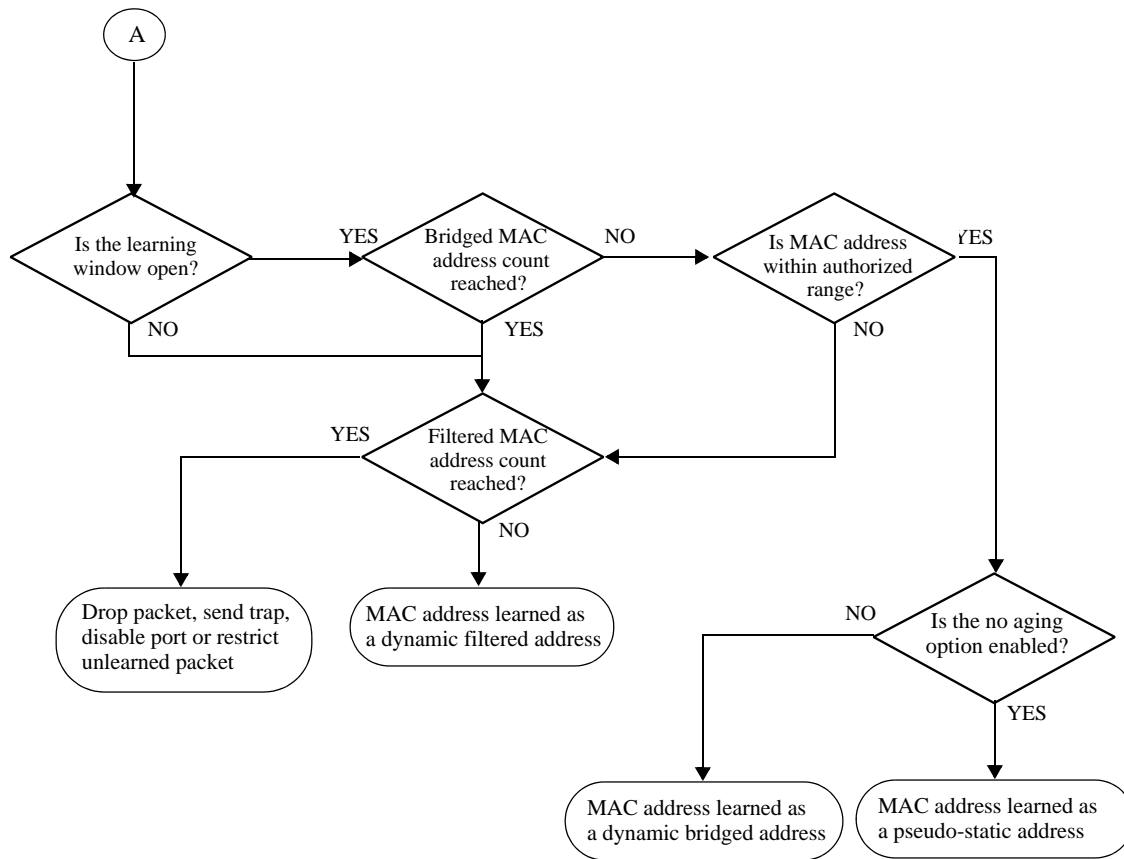

MAC Address Behavior on LPS Ports

The following table shows how LPS MAC addresses are treated when specific switch or LPS actions are taken:

Action	Static	Pseudo-Static	Dynamic Bridged	Dynamic Filtered
LPS port removed	Flushed	Flushed	Flushed	Flushed
Write memory	Written	Not written	Not written	Not written
Convert to static MAC	No change	Converted	Converted	No change
LPS admin disable	No change	No change	Flushed	Flushed
Enable after disable	No change	No change	Flushed	Flushed
LPS admin locked	No change	No change	No change	No change
Enable after locked	No change	No change	No change	No change
Aging bridged MAC	None	None	Aged entry removed	Flushed
Aging filtered MAC	None	None	No change	Aged entry removed
Remove static MAC	Entry removed	No change	Can learn one	Flushed
Remove pseudo-static MAC	No change	Entry removed	Can learn one	Flushed
Remove dynamic bridged	No change	No change	Can learn one	Flushed
Remove dynamic filtered	No change	No change	No change	Can learn one
Modify trap threshold	No change	No change	No change	No change

Action	Static	Pseudo-Static	Dynamic Bridged	Dynamic Filtered
Modify violation	No change	No change	No change	No change
Increase bridged maximum	No change	No change	Can learn more	Flushed
Decrease bridged maximum	No change	No change	Flushed	Flushed
Increase filtered maximum	No change	No change	No change	Can learn more
Decrease filtered maximum	No change	No change	No change	Flushed
Change MAC range	No change	No change	Flushed	Flushed
Changes During the Learning Window Time Period				
Disable boot up	No change	None	None	Can learn
Enable boot up	No change	None	Can learn	Can learn
Enable no aging	No change	Can learn	Don't learn	Can learn
Disable no aging	No change	Don't learn	Can learn	Can learn
Enable convert to static	No change	Convert at timeout	Convert at timeout	No change
Disable convert to static	No change	No change	No change	No change
Enable learn as static	No change	Convert to static	Convert to static	No change
Disable learn as static	No change	No change	No change	No change
Enable MAC movement	No change	MAC move allowed	No change	No change
Disable MAC movement	No change	No change	No change	No change

Note. If the LPS learning window time period is set to infinity, enabling the convert to static function is not allowed. If convert to static is already enabled and the learning window time is changed to infinity, convert to static is automatically disabled.

Dynamic Configuration of Authorized MAC Addresses

When LPS is configured on a switch port, the learning of source MAC addresses is initiated. An entry containing the address and the port that learns the MAC address is made in an LPS database table. This entry is used as a criteria for authorizing future traffic from the source MAC address on that same port. In other words, the learned MAC addresses are authorized to send traffic through the LPS port.

For example, if the source MAC address 00:da:95:00:59:0c is received on port 2/1/10 and meets the LPS restrictions defined for that port, then this address and its port are recorded in the LPS table. All traffic that is received on port 2/1/10 is compared to the 00:da:95:00:59:0c entry. If any traffic received on this port consists of packets that do not contain a matching source address, the packets are then subject to the LPS source learning time limit window and the criteria for maximum number of addresses allowed.

Static Configuration of Authorized MAC Addresses

It is also possible to statically configure authorized source MAC address entries into the LPS table. This type of entry behaves the same way as dynamically configured entries providing authorized port access to traffic that contains a matching source MAC address.

Static source MAC address entries, however, take precedence over dynamically learned entries. For example, if there are 2 static MAC address entries configured for port 2/1/1 and the maximum number allowed on port 2/1/1 is 10, then only 8 dynamically learned MAC addresses are allowed on this port.

There are four ways to configure a static source MAC address entry in the LPS table:

- Use the source learning command, **mac-learning static mac-address**, to manually configure a static MAC address for one or more LPS ports.
- Use the LPS learning window **no-aging** and **convert-to-static** options (see “[Configuring the LPS Learning Window](#)” on page 34-13 for more information).
- Use the LPS learning window **learn-as-static** option (see “[Configuring the LPS Learning Window](#)” on page 34-13 for more information).
- Use the LPS **port-security convert-to-static** command to manually convert all dynamic addresses on a specific port to static MAC addresses.

Note. Statically configured authorized MAC addresses are displayed permanently in the MAC address table for the specified LPS port; they are not learned on any other port in the same VLAN.

Understanding the LPS Table

The LPS database table is separate from the source learning MAC address table. However, when a MAC is authorized for learning on an LPS port, an entry is made in the MAC address table in the same manner as if it was learned on a non-LPS port (see [Chapter 3, “Managing Source Learning,”](#) for more information).

In addition to dynamic and configured source MAC address entries, the LPS table also provides the following information for each eligible LPS port:

- The LPS status for the port; enabled or disabled.
- The maximum number of MAC addresses allowed on the port.
- The maximum number of MAC addresses that can be filtered on the port.

- The violation mode selected for the port; restrict, discard, or shutdown.
- Statically configured MAC addresses and MAC address ranges.
- All MAC addresses learned on the port.
- The management status for the MAC address entry; configured or dynamic.

If the LPS port is shut down or the network device is disconnected from the port, the LPS table entries and the source learning MAC address table entries for the port are automatically cleared.

To view the contents of the LPS table, use the [show port-security](#) command. Refer to the *OmniSwitch AOS Release 8 CLI Reference Guide* for more information about this command.

Interaction With Other Features

This section contains important information about how the Learned Port Security (LPS) functionality interacts with other OmniSwitch features. Refer to the specific chapter for each feature to get more detailed information about how to configure and use the feature.

Access Guardian

LPS is one of the Access Guardian security functions that helps to ensure that only certain devices are allowed to connect to the switch. The LPS functionality is used to control which MAC addresses are allowed on a switch port.

Universal Network Profile (UNP)

- LPS is supported on UNP-enabled ports. When both of these features are enabled on the same port, UNP first authenticates and classifies any MAC addresses received, then LPS rules are applied. If a MAC address violates any of the LPS rules for the port, the address may get filtered or the port violated even if UNP initially determined the address was valid. In other words, LPS rules take precedence over UNP to determine if a MAC address is bridged or filtered on the port.
- When UNP is enabled on any one LPS port, the LPS learning window parameter options are not supported on all LPS-enabled ports. This is because the learning window configuration is global and applies to all LPS ports.

For more information about LPS on UNP ports, see [Chapter 39, “Learned Port Security Commands.”](#)

Configuring Learned Port Security

This section describes how to use Command Line Interface (CLI) command to configure Learned Port Security (LPS) on a switch. See the [“Sample Learned Port Security Configuration”](#) on page 34-3 for a brief tutorial on configuring LPS.

Configuring LPS involves the following procedures:

- Enabling LPS for one or more switch ports. This procedure is described in [“Configuring the LPS Port Administrative Status”](#) on page 34-11.
- Configuring the source learning time window during which MAC addresses are learned. This procedure is described in [“Configuring the LPS Learning Window”](#) on page 34-13.
- Configuring the maximum number of bridged MAC addresses allowed on an LPS port. This procedure is described in [“Configuring the Number of Bridged MAC Addresses Allowed”](#) on page 34-16.
- Configuring the maximum number of filtered MAC addresses allowed on an LPS port. This procedure is describe in [“Configuring the Number of Filtered MAC Addresses Allowed”](#) on page 34-17
- Configuring a range of authorized MAC addresses allowed on an LPS port. This procedure is described in [“Configuring an Authorized MAC Address Range”](#) on page 34-17.
- Specifying whether or not an LPS port shuts down all traffic or only restricts traffic when an unauthorized MAC address is received on the port. This procedure is described in [“Selecting the Security Violation Mode”](#) on page 34-18.

Configuring the LPS Port Administrative Status

The **port-security** command is used to configure the administrative status of LPS on a port using one of the following three parameter options:

enable	Enables LPS functionality on the port. When LPS is enabled: <ul style="list-style-type: none"> • All MAC addresses are cleared. • The LPS configuration is applied to source learning on the port. • The port can go into a shutdown, restricted, or discard state (based on the configured violation mode) when unauthorized addresses are received on the port.
disable	Disables LPS functionality on the port. When LPS is disabled: <ul style="list-style-type: none"> • All filtered and bridged MAC addresses are cleared. • Pseudo-static and static addresses remain in a forwarding state. • The static MAC configuration is retained. • The LPS configuration is retained but not applied. • Learning on the port is wide open; not restricted by LPS.
locked	Disables all learning on the port. When LPS is locked: <ul style="list-style-type: none"> • Existing MAC addresses are retained. • No additional learning is allowed. • Static MAC addresses are still allowed.

Enabling LPS Functionality on a Port

By default, LPS is disabled on all switch ports. To enable LPS on a port, use the **port-security** command with the **admin-state enable** parameter. For example, the following command enables LPS on port 4:

```
-> port-security port 1/1/4 admin-state enable
```

To enable LPS on multiple ports, specify a range of ports. For example:

```
-> port-security port 1/1/1-5 admin-state enable  
-> port-security port 1/1/12-20 admin-state enable
```

Note. When LPS is enabled on an active port, all MAC addresses learned on that port prior to the time LPS was enabled are cleared from the source learning MAC address table.

Disabling LPS Functionality on a Port

To disable LPS on a port, use the **port-security** command with the **admin-state disable** parameter. For example, the following command disables LPS on a range of ports:

```
-> port-security 1/1/21-24 admin-state disable
```

To disable all the LPS ports on a chassis, use the **port-security chassis admin-state** command, as shown:

```
-> port-security chassis admin-state disable
```

When LPS is disabled on a port, the MAC address entries for that port are retained in the LPS table. The next time LPS is enabled on the port, the same LPS table entries become active again. If there is a switch reboot before the switch configuration is saved, however, dynamic MAC address entries are discarded from the table.

Locking the LPS Port

To lock the LPS port, use the **port-security** command with the **admin-state locked** parameter. For example, the following command locks port 21:

```
-> port-security 1/1/21 admin-state locked
```

When the LPS port is locked, all learning on the port is stopped.

Removing the LPS Configuration from the Port

Use the **no** form of the **port-security** command to remove the LPS configuration and clear all entries (configured and dynamic) in the LPS table for the specified port. For example:

```
-> no port-security port 1/1/10
```

After LPS is removed, all the dynamic and static MAC addresses are flushed and unrestricted learning of new MAC addresses is enabled.

Configuring the LPS Learning Window

By default, the LPS source learning window time limit is set to infinity. This means that there is no limit on the amount of time during which MAC addresses are learned on all LPS ports. To limit the amount of time that source learning is allowed on LPS ports, use the [port-security learning-window](#) command.

During the time the learning window is open, source MAC addresses that comply with LPS port restrictions are authorized for source learning on the related LPS port. The following actions trigger the start of the learning window timer:

- Using the **port-security learning-window** command. Each time this command is issued, the timer restarts even if a current window is still open.
- A switch reboot with the **port-security learning-window** command entry saved in the **vcboot.cfg** file. When this command is used to configure the learning window time and related options for the switch, use the **write memory** command to ensure the command is saved in the **vcboot.cfg** file.

The LPS learning window time limit is a switch-wide parameter that applies to all LPS-enabled ports, not just one or a group of LPS ports. The following command example sets the time limit value to 30 minutes:

```
-> port-security learning-window 30
```

Note. When the time limit value expires, source learning of any new dynamic bridged MAC addresses is stopped on all LPS ports, even if the number of bridged addresses learned does not exceed the maximum allowed. However, after the window has closed, the switch will continue to learn dynamic filtered MAC addresses until the maximum number of filtered addresses allowed is reached.

Setting the LPS learning window time value to zero (the default) configures an infinite learning window for LPS ports. For example:

```
-> port-security learning-window 0
```

Use the [show port-security learning-window](#) command to determine the current settings for the LPS learning window.

Configuring Learning Window Parameters

In addition to specifying the duration of the LPS learning window, the **port-security learning-window** command provides the following parameters for configuring additional learning window options:

no-aging	Specifies whether or not learned dynamic MAC addresses can age out. See “Configuring the MAC Address Aging Status” on page 34-14.
convert-to-static	Specifies whether or not learned dynamic bridged MAC addresses are converted to static MAC addresses when the learning window closes. See “Converting Dynamic MAC Addresses to Static MAC Addresses” on page 34-14.
learn-as-static	Specifies whether or not learned dynamic bridged MAC addresses are automatically converted to static MAC addresses during the learning window time frame. See “Learning MAC Addresses as Static MAC Addresses” on page 34-15.

mac-move	Specifies whether or not a pseudo-static MAC address learned on one LPS port can move to another LPS port in the same VLAN without getting dropped. See “Configuring the MAC Movement Status” on page 34-15.
boot-up	Specifies whether or not the learning window timer will automatically start each time the switch restarts. See “Starting the Learning Window at Boot Up” on page 34-16.

Configuring the MAC Address Aging Status

During the learning window time period, dynamically learned MAC addresses may age out before the learning window time is up. To prevent this from happening, use the **no-aging enable** parameter option with the **port-security learning-window** command.

When this option is enabled, all dynamic bridged MAC addresses are learned as pseudo-static MAC addresses. This type of address is treated as a regular statically configured address and will not age out, even after the learning window closes. However, pseudo-static MAC addresses are not saved in the switch configuration.

The no MAC address aging option is best used in combination with the option that converts dynamic addresses to static address. Enabling both of these options ensures that no learned MAC addresses will age out before or after the learning window closes.

By default, the no MAC address aging status is disabled. To enable this option for the learning window, use the following command:

```
-> port-security learning-window no-aging enable
```

To disable this option for the learning window, use the following command:

```
-> port-security learning-window no-aging disable
```

Converting Dynamic MAC Addresses to Static MAC Addresses

When the learning window time expires, all the dynamic MAC addresses learned on the LPS ports start to age out. The **convert-to-static** parameter option of the **port-security learning-window** command is used to specify whether or not these MAC addresses are converted to static addresses when the learning window time period ends.

The number of converted static MAC addresses cannot exceed the maximum number of MAC addresses allowed on the LPS ports.

By default, converting dynamic MAC addresses to static MAC addresses is disabled. To enable this option for the learning window, use the following command:

```
-> port-security learning-window 30 convert-to-static enable
```

If the LPS learning window time is set to zero (infinity), enabling the **convert-to-static** option is not allowed. For example:

```
-> port-security learning-window 0 convert-to-static enable
ERROR: Convert-to-static cannot be configured along with infinite learning-
window
```

The following command disables this option for the learning window:

```
-> port-security learning-window 30 convert-to-static disable
```

If the LPS learning window is set to a specific time and the **convert-to-static** option is enabled, the **convert-to-static** option is automatically disabled when the learning window time is set to zero. For example:

```
-> port-security learning-window 10 convert-to-static enable

-> show port-security learning-window
Learning-Window           = 10 min,
Convert-to-static         = ENABLE,
No Aging                  = DISABLE,
Boot Up                   = ENABLE,
Learn As Static           = DISABLE,
Mac Move                  = DISABLE,
Remaining Learning Window = 594 sec,

-> port-security learning-window 0

-> show port-security learning-window
Learning-Window           = INFINITY,
Convert-to-static         = DISABLE,
No Aging                  = DISABLE,
Boot Up                   = ENABLE,
Learn As Static           = DISABLE,
Mac Move                  = DISABLE
```

Learning MAC Addresses as Static MAC Addresses

If a switch reboots during an active LPS learning window, MAC addresses learned up to that point are lost. To prevent this from happening, use the **learn-as-static enable** parameter option with the **port-security learning-window** command.

When this option is enabled, all MAC addresses are automatically learned as static MAC addresses during the learning window time period. These static MAC addresses are saved to the switch configuration.

By default, the option to learn MAC addresses as static MAC addresses is disabled. To enable this option for the learning window, use the following command:

```
-> port-security learning-window 30 learn-as-static enable
```

The following command disables this option for the learning window:

```
-> port-security learning-window 30 learn-as-static disable
```

Configuring the MAC Movement Status

MAC addresses are learned as pseudo-static MAC addresses when the **no-aging** option is enabled for the LPS learning window. If a duplicate pseudo-static MAC address is seen on another port in the same VLAN, the MAC address is dropped. To prevent this from happening, use the **mac-move enable** parameter option with the **port-security learning-window** command.

When MAC movement is enabled, a pseudo-static MAC address can move to another port within the same VLAN without getting dropped. After the move has occurred, the switch configuration is updated to reflect the new port association for the pseudo-static MAC address. No information about the original port association is retained.

By default, the MAC movement option is disabled. To enable this option for the learning window, use the following command:

```
-> port-security learning-window 30 mac-move enable
```

The following command disables this option for the learning window:

```
-> port-security learning-window 30 mac-move disable
```

Starting the Learning Window at Boot Up

By default, the **boot-up** option is enabled when the learning window time is configured. This option specifies that whenever the switch reboots, the learning window time period will automatically restart at the time the reboot occurs.

To disable this functionality, use the **boot-up disable** parameter with the **port-security learning-window** command. For example:

```
-> port-security learning-window boot-up disable
```

To enable this functionality, use the **boot-up enable** parameter with the **port-security learning-window** command. For example:

```
-> port-security learning-window boot-up enable
```

Note. After the **boot-up** option is enabled (either by default or explicitly configured), perform the **write memory** command to save the **port-security learning-window** command to the switch configuration (**vcboot.cfg** file). This will ensure that the learning window will automatically start when the switch reboots.

Configuring the Number of Bridged MAC Addresses Allowed

To configure the number of bridged MAC addresses allowed on an LPS port, use the **port-security maximum** command. For example, the following command sets the maximum number of MAC addresses learned on port 10 to 75:

```
-> port-security port 1/1/10 maximum 75
```

To specify a maximum number of MAC addresses allowed for multiple ports, specify a range of ports. For example:

```
-> port-security port 1/1/10-15 maximum 10  
-> port-security port 1/1/1-5 maximum 25
```

If there are 10 configured authorized MAC addresses for an LPS port and the maximum number of addresses allowed is set to 15, then only 5 dynamically learned MAC address are allowed on this port.

If the maximum number of MAC addresses allowed is reached before the switch LPS time limit expires, then all source learning of dynamic *and* configured bridged MAC addresses is stopped on the LPS port. However, the switch will continue to learn subsequent addresses as filtered until the maximum number of filtered MAC addresses allowed on the port is reached.

Configuring the Trap Threshold for Bridged MAC Addresses

The LPS trap threshold value determines how many bridged MAC addresses the port must learn before a trap is sent. Once this value is reached, a trap is sent for every MAC learned thereafter.

By default, when one bridged MAC addresses is learned on an LPS port, the switch sends a trap. To change the trap threshold value, use the **port-security learn-trap-threshold** command. For example:

```
-> port-security port learn-trap-threshold 10
```

Sending a trap when this threshold is reached provides notification of newly learned bridged MAC addresses. Trap contents includes identifying information about the MAC, such as the address itself, the corresponding IP address, switch identification, and the port number on which the MAC was learned.

Configuring the Number of Filtered MAC Addresses Allowed

To configure the number of filtered MAC addresses allowed on an LPS port, use the **port-security port max-filtering** command. For example, the following command sets the maximum number of filtered MAC addresses learned on port 9 to 18:

```
-> port-security port 1/1/9 max-filtering 18
```

To specify a maximum number of filtered MAC addresses learned on multiple ports, specify a range of ports or multiple slots. For example:

```
-> port-security port 1/1/9-15 max-filtering 10  
-> port-security port 1/1/1-5 max-filtering 25
```

If the maximum number of filtered MAC addresses allowed is reached:

- The violation mode configured for the LPS port is applied (see [“Selecting the Security Violation Mode” on page 34-18](#) for more information).
- An SNMP trap is generated.
- An event is entered into the switch log.

Configuring an Authorized MAC Address Range

By default, each LPS port is set to a range of 00:00:00:00:00:00–ff:ff:ff:ff:ff:ff, which includes all MAC addresses. If this default is not changed, then addresses received on LPS ports are subject only to the learning window time and restrictions on the maximum number of MAC addresses allowed for the port.

All MAC addresses that fall within the default or a specific configured range of addresses are dynamically learned as bridged MAC addresses (up to the maximum of bridged addresses allowed). If a MAC address falls outside of the specified range, the address is dynamically learned as a filtered MAC address (up to the maximum of filtered addresses allowed).

To configure a source MAC address range for an LPS port, use the **port-security mac-range** command. For example, the following command configures a MAC address range for port 1 on slot 4:

```
-> port-security port 1/1/1 mac-range low 00:20:da:00:00:10 high  
00:20:da:00:00:50
```

The following command examples configure a MAC address range for a range of ports:

```
-> port-security port 1/1/1-5 mac-range low 00:20:da:00:00:10 high  
00:20:da:00:00:50  
-> port-security port 1/1/1-4 mac-range low 00:20:d0:59:0c:9a high  
00:20:d0:59:0c:9f
```

To restore the range to the default values, use the **port-security** parameter followed by the **port** keyword and *port* designation of the port and the **mac-range**. The MAC address range is restored to 00:00:00:00:00:00 and ff:ff:ff:ff:ff:ff when the **low** and **high** MAC addresses are excluded. For example, the following command sets the authorized MAC address range to the default values for port 12:

```
-> port-security port 1/1/12 mac-range
```

In addition, specifying a low end MAC and a high end MAC is optional. If either one is not specified, the default value is used. For example, the following commands set the authorized MAC address range on the specified ports to 00:da:25:59:0c:10–ff:ff:ff:ff:ff:ff and 00:00:00:00:00:00–00:da:25:00:00:9a:

```
-> port-security port 1/1/8 mac-range low pp:da:25:59:0c
-> port-security port 1/1/10 mac-range high 00:da:25:00:00:9a
```

Refer to the *OmniSwitch AOS Release 8 CLI Reference Guide* for more information about this command.

Selecting the Security Violation Mode

The **port-security port violation** command configures the violation mode (restrict, discard, or shutdown) that is applied to an LPS port when the maximum number of bridged and filtered addresses allowed on the port is reached. Use the following table to determine how each violation mode is applied and which actions or events will clear the violation state and return the port to normal operation:

Mode (Parameter)	Violation Mode Description	Violation Recovery
restrict	Port remains up but unauthorized MAC addresses are blocked. All other packets that contain an authorized source MAC address are allowed to continue forwarding on the port.	<ul style="list-style-type: none"> • Bridge and filtered MAC addresses age out. • MAC addresses are flushed. • Use clear violation command. • Link down/up event. • LPS port is removed.
discard	Port remains up but all traffic received on the port is discarded. Dynamically learned MAC addresses are flushed.	<ul style="list-style-type: none"> • Use clear violation command. • Link down/up event. • LPS port is removed.
shutdown	Port is administratively disabled. All traffic is stopped at the port; no traffic is forwarded.	<ul style="list-style-type: none"> • Use clear violation command. • Link down/up event. • LPS port is removed.

Note. Unauthorized source MAC addresses are not learned in the LPS table but are still recorded in the source learning MAC address table with a filtered operational status. This allows the user to view MAC addresses that were attempting unauthorized access to the LPS port.

By default, the security violation mode for an LPS port is set to **restrict**. To configure the security violation mode for an LPS port, enter **port-security** followed by the *port* designation of the port, then **violation** followed by **restrict**, **discard**, or **shutdown**. For example, the following command selects the shutdown mode for port 1:

```
-> port-security port 1/1/1 violation shutdown
```

To configure the security violation mode for multiple LPS ports, specify a range of ports or multiple slots. For example:

```
-> port-security port 1/1/1-10 violation shutdown
-> port-security port 1/1/10-15 violation restrict
```

Note. To verify the details about LPS violations, use the **show violation** command.

```
-> show violation
```

Port	Source	Action	Reason	Timer
1/1/1	src lrn	simulated down	lps shutdown	0
1/1/2	qos	simulated down	policy	0
2	udld	admin down	udld	0

To clear all the LPS violation information use the **clear violation** command.

Displaying Learned Port Security Information

To display LPS port and table information, use the **show** commands listed below:

show port-security	Displays Learned Port Security (LPS) configuration and table entries.
show port-security learning-window	Displays the amount of time during which source learning can occur on all LPS ports.
show violation	Displays the address violations that occur on ports with LPS restrictions.

For more information about the resulting display from these commands, see the *OmniSwitch AOS Release 8 CLI Reference Guide*. An example of the output for the **show port-security**, **show port-security learning-window** and **show violation** commands is also given in “[Sample Learned Port Security Configuration](#)” on page 34-3.

35 Diagnosing Switch Problems

Several tools are available for diagnosing problems that occur with the switch. These tools include:

- Port Mirroring
- Port Monitoring
- sFlow
- Remote Monitoring (RMON) probes
- Switch Health Monitoring

Port mirroring copies all incoming and outgoing traffic from configured mirror ports to a second mirroring Ethernet port, where it can be monitored with a Remote Network Monitoring (RMON) probe or network analysis device without disrupting traffic flow on the mirrored port. The port monitoring feature allows you to examine packets to and from a specific Ethernet port. sFlow is used for measuring high speed switched network traffic. It is also used for collecting, storing, and analyzing the traffic data. Switch Health monitoring software checks previously configured threshold levels for the switch's consumable resources, and notifies the Network Monitoring Station (NMS) if those limits are violated.

In This Chapter

This chapter describes port mirroring, port monitoring, remote monitoring (RMON) probes, sFlow, and switch health features and explains how to configure the same through the Command Line Interface (CLI).

Configuration procedures described in this chapter include:

- [Creating or Deleting a Port Mirroring Session](#)—see [“Creating a Mirroring Session” on page 35-17](#) or [“Deleting A Mirroring Session” on page 35-20](#).
- [Protection from Spanning Tree changes \(Port Mirroring\)](#)—see [“Unblocking Ports \(Protection from Spanning Tree\)” on page 35-18](#).
- [Enabling or Disabling Port Mirroring Status](#)—see [“Enabling or Disabling Mirroring Status” on page 35-18](#) or [“Disabling a Mirroring Session \(Disabling Mirroring Status\)” on page 35-19](#).
- [Configuring Port Mirroring Direction](#)—see [“Configuring Port Mirroring Direction” on page 35-19](#).
- [Enabling or Disabling a Port Mirroring Session](#)—see [“Enabling or Disabling a Port Mirroring Session \(Shorthand\)” on page 35-20](#).
- [Configuring a Port Monitoring Session](#)—see [“Configuring a Port Monitoring Session” on page 35-23](#).
- [Enabling a Port Monitoring Session](#)—see [“Enabling a Port Monitoring Session” on page 35-23](#).

- [Disabling a Port Monitoring Session](#)—see “[Disabling a Port Monitoring Session](#)” on page 35-23.
- [Deleting a Port Monitoring Session](#)—see “[Deleting a Port Monitoring Session](#)” on page 35-23.
- [Pausing a Port Monitoring Session](#)—see “[Pausing a Port Monitoring Session](#)” on page 35-24.
- [Configuring the persistence of a Port Monitoring Session](#)—see “[Configuring Port Monitoring Session Persistence](#)” on page 35-24.
- [Configuring a Port Monitoring data file](#)—see “[Configuring a Port Monitoring Data File](#)” on page 35-24.
- [Configuring a Port Monitoring direction](#)—see “[Configuring Port Monitoring Direction](#)” on page 35-25.
- [Configuring capture-type](#)—see “[Configuring Capture Type](#)” on page 35-25.
- [Displaying Port Monitoring Status and Data](#)—see “[Displaying Port Monitoring Status and Data](#)” on page 35-25.
- [Configuring a sFlow Session](#)—see “[Configuring an sFlow Session](#)” on page 35-27.
- [Configuring a Fixed Primary Address](#)—see “[Configuring a Fixed Primary Address](#)” on page 35-28.
- [Displaying a sFlow Receiver](#)—see “[Displaying an sFlow Receiver](#)” on page 35-28.
- [Displaying a sFlow Sampler](#)—see “[Displaying an sFlow Sampler](#)” on page 35-28.
- [Displaying a sFlow Poller](#)—see “[Displaying an sFlow Poller](#)” on page 35-29.
- [Displaying a sFlow Agent](#)—see “[Displaying an sFlow Agent](#)” on page 35-29.
- [Deleting a sFlow Session](#)—see “[Deleting an sFlow Session](#)” on page 35-29.
- [Enabling or Disabling RMON Probes](#)—see “[Enabling or Disabling RMON Probes](#)” on page 35-32.
- [Configuring Resource Threshold Limits \(Switch Health\)](#)—see “[Configuring Resource Thresholds](#)” on page 35-38.
- [Configuring Sampling Intervals](#)—see “[Configuring Sampling Intervals](#)” on page 35-39.

For information about additional Diagnostics features such as Switch Logging and System Debugging/Memory Management commands, see [Chapter 37, “Using Switch Logging.”](#)

Port Mirroring Overview

The following sections detail the specifications, defaults, and quick set up steps for the port mirroring feature. Detailed procedures are found in [“Port Mirroring” on page 35-14](#).

Port Mirroring Specifications

Platforms Supported	OmniSwitch 6860, 6860E
Ports Supported	Ethernet (10 Mbps) Fast Ethernet (100 Mbps) Gigabit Ethernet (1 Gbps) 10 Gigabit Ethernet (10 Gbps)
Mirroring Sessions Supported	2
Combined Mirroring/Monitoring Sessions per Chassis	2
N-to-1 Mirroring Supported	128 to 1
Number of RPMIR VLANs per session	1

Port Mirroring Defaults

The following table shows port mirroring default values.

Parameter Description	CLI Command	Default Value/Comments
Mirroring Session Creation	port-mirroring source destination	No Mirroring Sessions Configured
Protection from Spanning Tree (Spanning Tree Disable)	port-mirroring source destination	Spanning Tree Enabled
Mirroring Status Configuration	port-mirroring source destination	Enabled
Mirroring Session Configuration	port-mirroring	Enabled
Mirroring Session Deletion	port-mirroring	No Mirroring Sessions Configured

Quick Steps for Configuring Port Mirroring

1 Create a port mirroring session. Be sure to specify the port mirroring session ID, source (*mirrored*) and destination (*mirroring*) ports, and unblocked VLAN ID (*optional*—protects the mirroring session from changes in Spanning Tree if the mirroring port monitors mirrored traffic on an RMON probe belonging to a different VLAN). For example:

```
-> port-mirroring 6 source 2/1/3-9 destination 2/1/10 unblocked-vlan 7
```

Note. *Optional.* To verify the port mirroring configuration, enter **show port-mirroring status** followed by the port mirroring session ID number. The display is similar to the one shown below:

```
-> show port-mirroring status 6
```

Session	Mirror Destination	Mirror Direction	Unblocked Vlan	Config Status	Oper Status
6.	2/1/10	-	NONE	Enable	On
	Mirror Source				
6.	2/1/3	bidirectional	-	Enable	On
6.	2/1/4	bidirectional	-	Enable	On
6.	2/1/5	bidirectional	-	Enable	On
6.	2/1/6	bidirectional	-	Enable	On
6.	2/1/7	bidirectional	-	Enable	On
6.	2/1/8	bidirectional	-	Enable	On
6.	2/1/9	bidirectional	-	Enable	On

For more information about this command, see [“Displaying Port Mirroring Status”](#) on page 35-20 or the “Port Mirroring and Monitoring Commands” chapter in the *OmniSwitch AOS Release 8 CLI Reference Guide*.

Port Monitoring Overview

The following sections detail the specifications, defaults, and quick set up steps for the port mirroring feature. Detailed procedures are found in [“Port Monitoring” on page 35-22](#).

Port Monitoring Specifications

Platforms Supported	OmniSwitch 6860, 6860E
Ports Supported	Ethernet (10 Mbps) Fast Ethernet (100 Mbps) Gigabit Ethernet (1 Gbps) 10 Gigabit Ethernet (10 Gbps)
Monitoring Sessions Supported	1
Combined Mirroring/Monitoring Sessions per Chassis	2
File Type Supported	ENC file format (Network General Sniffer Network Analyzer Format)

Port Monitoring Defaults

The following table shows port mirroring default values.

Parameter Description	CLI Command	Default Value/Comments
Monitoring Session Creation	port-monitoring source	No Monitoring Sessions Configured
Monitoring Status	port-monitoring source	Disabled
Monitoring Session Configuration	port-monitoring source	Disabled
Port Monitoring Direction	port-monitoring source	Bidirectional
Data File Creation	port-monitoring source	Enabled
Data File Size	port-monitoring source	64K
File Overwriting	port-monitoring source	Enabled
Time before session is deleted	port-monitoring source	0 seconds
Capture-type	port-monitoring source	brief

Quick Steps for Configuring Port Monitoring

1 To create a port monitoring session, use the **port-monitoring source** command by entering **port monitoring**, followed by the port monitoring session ID, **source**, and the port number of the port to be monitored. For example:

```
-> port-monitoring 6 source 2/1/3
```

2 Enable the port monitoring session by entering **port-monitoring**, followed by the port monitoring session ID, **source**, the port number of the port to be monitored, and **enable**. For example:

```
-> port-monitoring 6 source 2/1/3 enable
```

3 *Optional.* Configure optional parameters. For example, to create a file called “monitor1” for port monitoring session 6 on port 2/3, enter:

```
-> port-monitoring 6 source 2/1/3 file monitor1
```

Note. *Optional.* To verify the port monitoring configuration, enter **show port-monitoring status**, followed by the port monitoring session ID number. The display is similar to the one shown below:

```
-> show port-monitoring status
```

Sess	Mon. Src	Mon Dir	Over write	Oper. Stat	Admin Stat	Capt. Type	Max. Size	File Name
6.	2/1/3	Bidirectional	ON	ON	ON	brief		

For more information about this command, see [“Port Monitoring” on page 35-22](#) or the “Port Mirroring and Monitoring Commands” chapter in the *OmniSwitch AOS Release 8 CLI Reference Guide*.

sFlow Overview

The following sections detail the specifications, defaults, and quick set up steps for the sFlow feature. Detailed procedures are found in “sFlow” on page 35-26.

sFlow Specifications

RFCs Supported	3176 - sFlow Management Information Base
Platforms Supported	OmniSwitch 6860, 6860E
Receiver/Sampler/Polling Instances	2
Sampling	length of packet type of frame source and destination MACs source and destination VLANs source and destination priorities source and destination IP addresses source and destination ports tcp flags and tos
Polling	In octets Out octets Number of Rx Unicast packets Number of Tx Unicast packets Number of Rx Multicast packets Number of Tx Multicast packets Number of Rx Broadcast packets Number of Tx Broadcast packets In Errors Out Errors
Agent IP Address	Configurable using sflow agent ip command.

sFlow Defaults

The following table shows sFlow default values:

Parameter Description	CLI Command	Default Value/Comments
Receiver Name	sflow receiver	Empty
Receiver Timeout Value	sflow receiver	No Timeout
Receiver IP Address	sflow receiver	0.0.0.0
Receiver Data File Size	sflow receiver	1400 Bytes
Receiver Version Number	sflow receiver	5
Receiver Destination Port	sflow receiver	6343
Sampler Rate	sflow sampler	0
Sample Header Size	sflow sampler	128 Bytes
Poller Interval Value	sflow poller	5 seconds

Quick Steps for Configuring sFlow

Follow the steps below to create an sFlow receiver session.

1 To create a sFlow receiver session, use the **sflow receiver** command by entering **sflow receiver**, followed by the receiver index, name, and the IP address. For example:

```
-> sflow receiver 1 name Golden address 198.206.181.3
```

2 *Optional.* Configure optional parameters. For example, to specify the timeout value “65535” for sFlow receiver session on address 198.206.181.3, enter:

```
-> sflow receiver 1 name Golden address 198.206.181.3 timeout 65535
```

Note. *Optional.* To verify the sFlow receiver configuration, enter **show sflow receiver**, followed by the sFlow receiver index. The display is similar to the one shown below:

```
-> show sflow receiver

Receiver 1
Name       = Golden
Address    = IP_V4 198.206.181.3
UDP Port   = 6343
Timeout    = 65535
Packet Size= 1400
DatagramVer= 5
```

For more information about this command, see “sFlow” on page 35-26 or the “sFlow Commands” chapter in the *OmniSwitch AOS Release 8 CLI Reference Guide*.

Follow the steps below to create a sFlow sampler session.

1 To create a sFlow sampler session, use the **sflow sampler** command by entering **sflow sampler**, followed by the instance ID, port list, receiver, and the rate. For example:

```
-> sflow sampler 1 2/1/1-5 receiver 1 rate 2048
```

2 *Optional.* Configure optional parameters. For example, to specify the sample-hdr-size value “128” for sFlow sampler instance 1 on ports 2/1-5, enter:

```
-> sflow sampler 1 2/1/1-5 receiver 1 rate 2048 sample-hdr-size 128
```

Note. *Optional.* To verify the sFlow sampler configuration, enter **show sflow sampler**, followed by the sFlow sampler instance ID. The display is similar to the one shown below:

```
-> show sflow sampler 1
Instance Interface  Receiver  Rate  Sample-Header-Size
-----
1           2/1/1           1        2048  128
1           2/1/2           1        2048  128
1           2/1/3           1        2048  128
1           2/1/4           1        2048  128
1           2/1/5           1        2048  128
```

For more information about this command, see “sFlow” on page 35-26 or the “sFlow Commands” chapter in the *OmniSwitch AOS Release 8 CLI Reference Guide*.

Follow the steps below to create a sFlow poller session.

1 To create a sFlow poller session, use the **sflow poller** command by entering **sflow poller**, followed by the instance ID, port list, receiver, and the interval. For example:

```
-> sflow poller 1 2/1/6-10 receiver 1 interval 30
```

Note. *Optional.* To verify the sFlow poller configuration, enter **show sflow poller**, followed by the sFlow poller instance ID. The display is similar to the one shown below:

```
-> show sflow poller
Instance Interface      Receiver  Interval
-----
1           2/1/6           1         30
1           2/1/7           1         30
1           2/1/8           1         30
1           2/1/9           1         30
1           2/1/10          1         30
```

For more information about this command, see [“sFlow” on page 35-26](#) or the “sFlow Commands” chapter in the *OmniSwitch AOS Release 8 CLI Reference Guide*.

Remote Monitoring (RMON) Overview

The following sections detail the specifications, defaults, and quick set up steps for the RMON feature. Detailed procedures are found in [“Remote Monitoring \(RMON\)” on page 35-30](#).

RMON Specifications

RFCs Supported	2819 - Remote Network Monitoring Management Information Base
Platforms Supported	OmniSwitch 6860, 6860E
RMON Functionality Supported	Basic RMON 4 group implementation –Ethernet Statistics group –History (Control and Statistics) group –Alarms group –Events group
RMON Functionality Not Supported	RMON 10 group* RMON2* –Host group –HostTopN group –Matrix group –Filter group –Packet Capture group (*An external RMON probe that includes RMON 10 group and RMON2 be used where full RMON probe functionality is required.)
Flavor (Probe Type)	Ethernet/History/Alarm
Status	Active/Creating/Inactive
History Control Interval (seconds)	1 to 3600
History Sample Index Range	1 to 65535
Alarm Interval (seconds)	1 to 2147483647
Alarm Startup Alarm	Rising Alarm/Falling Alarm/ RisingOrFalling Alarm
Alarm Sample Type	Delta Value/Absolute
RMON Traps Supported	RisingAlarm/FallingAlarm These traps are generated whenever an Alarm entry crosses either its Rising Threshold or its Falling Threshold and generates an event configured for sending SNMP traps.

RMON Probe Defaults

The following table shows Remote Network Monitoring default values.

Parameter Description	CLI Command	Default Value/Comments
RMON Probe Configuration	rmon probes	No RMON probes configured.

Quick Steps for Enabling/Disabling RMON Probes

1 Enable an inactive (or disable an active) RMON probe, where necessary. You can also enable or disable all probes of a particular flavor, if desired. For example:

```
-> rmon probes stats 1011 enable
-> rmon probes history disable
```

2 To verify the RMON probe configuration, enter the **show rmon probes** command, with the keyword for the type of probe. For example, to display the statistics probes, enter the following:

```
-> show rmon probes stats
```

The display is similar to the one shown below:

Entry	Chas/Slot/Port	Flavor	Status	Duration	System Resources
1011	1/1/11	Ethernet	Active	11930:27:05	272 bytes

3 To view statistics for a particular RMON probe, enter the **show rmon probes** command, with the keyword for the type of probe, followed by the entry number for the desired RMON probe. For example:

```
-> show rmon probes 1011
```

The display appears similar to the one shown below:

```
Probe's Owner: Switch Auto Probe on Chass1, Slot 1, Port 11
Entry 1011
Flavor = Ethernet, Status = Active,
Time = 11930 hrs 26 mins,
System Resources (bytes) = 272
```

For more information about these commands, see [“Displaying a List of RMON Probes” on page 35-33](#), [“Displaying Statistics for a Particular RMON Probe” on page 35-34](#), or the “RMON Commands” chapter in the *OmniSwitch AOS Release 8 CLI Reference Guide*.

Switch Health Overview

The following sections detail the specifications, defaults, and quick set up steps for the switch health feature. Detailed procedures are found in [“Monitoring Switch Health” on page 35-37](#).

Switch Health Specifications

Platforms Supported	OmniSwitch 6860, 6860E
Health Functionality Supported	<ul style="list-style-type: none"> –Switch level CPU Utilization Statistics (percentage); –Switch/module/port level Input Utilization Statistics (percentage); –Switch/module/port level Input/Output Utilization Statistics (percentage); –Switch level Memory Utilization Statistics (percentage); –Device level (for example, Chassis/CMM) Temperature Statistics (Celsius).
Monitored Resource Utilization Levels	<ul style="list-style-type: none"> –Most recent utilization level; –Average utilization level during last minute; –Average utilization level during last hour; –Maximum utilization level during last hour.
Resource Utilization Raw Sample Values	Saved for previous 60 seconds.
Resource Utilization Current Sample Values	Stored.
Resource Utilization Maximum Utilization Value	Calculated for previous 60 seconds and stored.
Utilization Value = 0	Indicates that none of the resources were measured for the period.
Utilization Value = 1	Indicates that a non-zero amount of the resource (less than 2%) was measured for the period.
Percentage Utilization Values	Calculated based on Resource Measured During Period/Total Capacity.
Resource Threshold Levels	Apply automatically across all levels of switch (switch/module/port).
Rising Threshold Crossing	A Resource Threshold was exceeded by its corresponding utilization value in the current cycle.
Falling Threshold Crossing	A Resource Threshold was exceeded by its corresponding utilization value in the previous cycle, but is not exceeded in the current cycle.
Threshold Crossing Traps Supported	Device, module, port-level threshold crossings.

Switch Health Defaults

The following table shows Switch Health default values.

Parameter Description	CLI Command	Default Value/Comments
Resource Threshold Limit Configuration	health threshold	80 percent
Sampling Interval Configuration	health interval	5 seconds
Switch Temperature	health threshold	60 degrees Celsius

Quick Steps for Configuring Switch Health

1 Display the health threshold limits, health sampling interval settings, and/or health statistics for the switch, depending on the parameters you wish to modify. (For best results, note the default settings for future reference.) For example:

```
-> show health configuration
```

The default settings for the command you entered is displayed. For example:

```
Rx Threshold           = 80
TxRx Threshold         = 80
Memory Threshold       = 80
CPU Threshold          = 80
Sampling Interval (Secs) = 10
```

2 Enter the appropriate command to change the required health threshold or health sampling interval parameter settings or reset all health statistics for the switch. For example:

```
-> health threshold memory 85
```

Port Mirroring

On chassis-based or standalone switches, you can set up port mirroring sessions between Ethernet ports within the same switch.

All Ethernet ports support port mirroring. When port mirroring is enabled, the active “mirrored” port transmits and receives network traffic normally, and the “mirroring” port receives a copy of all transmit and receive traffic to the active port. You can connect an RMON probe or network analysis device to the mirroring port to see an exact duplication of traffic on the mirrored port without disrupting network traffic to and from the mirrored port.

Port mirroring runs in the Chassis Management software and is supported for Ethernet ports. In addition, the switch supports “N-to-1” port mirroring, where up to 128 source ports can be mirrored to a single destination port.

Refer to the Port Mirroring Specifications Table in the [“Port Mirroring Overview” on page 35-3](#) for the number of mirroring sessions supported.

What Ports Can Be Mirrored?

Mirroring between any similar ports and between any SFP to any other SFP port is supported.

How Port Mirroring Works

When a frame is received on a mirrored port, it is copied and sent to the mirroring port. The received frame is actually transmitted twice across the switch backplane—once for normal bridging and then again to the mirroring port.

When a frame is transmitted by the mirrored port, a copy of the frame is made, tagged with the mirroring port as the destination, and sent back over the switch backplane to the mirroring port. The diagram below illustrates the data flow between the mirrored and mirroring ports.

Note. When port mirroring is enabled, some performance degradation may occur, since all frames received and transmitted by the mirrored port are copied and sent to the mirroring port

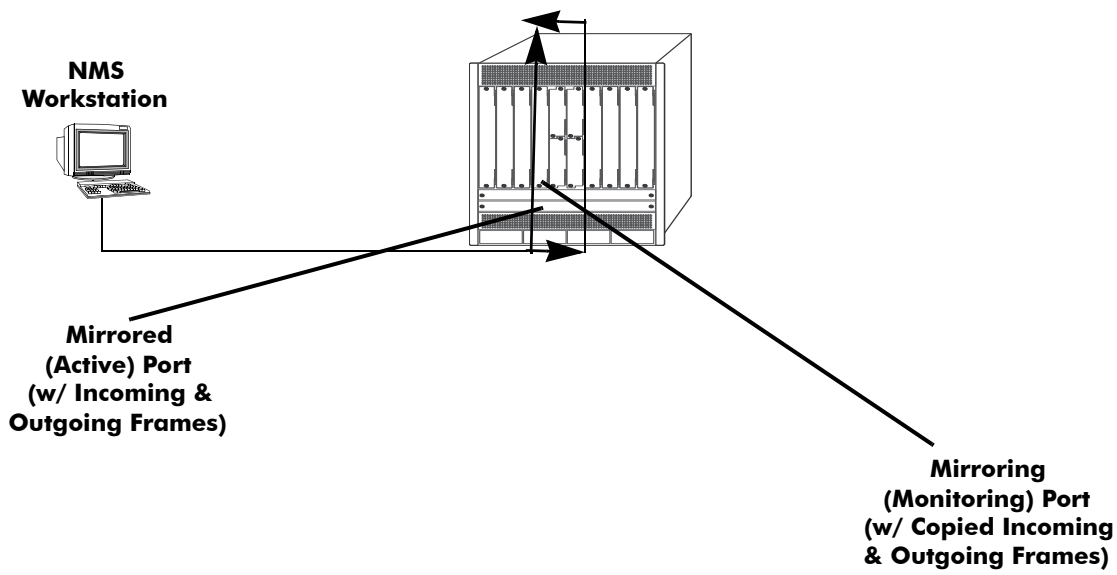

Relationship Between Mirrored and Mirroring Ports

What Happens to the Mirroring Port

Mirroring Port (MTP), can not be assigned to a port with Tagged VLAN configured on it. Once the Mirroring Port (MTP) is configured the port does not belong to any VLAN. Inbound traffic into the MTP is dropped, since it does not belong to any VLAN. When unblocked VLAN is configured, the VLAN ID specified is assigned to the MTP port as the default VLAN. Hence allowing inbound traffic and handling traffic for that VLAN ID. Spanning tree remains disabled on MTP port.

Mirroring on Multiple Ports

If mirroring is enabled on multiple ports and the same traffic is passing through these ports, then only one copy of each packet is sent to the mirroring destination. When the packet is mirrored for the first time, the switching ASIC flags the packet as “already mirrored” If the packet goes through one more port where mirroring is enabled, that packet is not mirrored again. If both mirroring and monitoring are enabled then the packet is either mirrored or monitored (that is sent to CPU), whichever comes first.

Using Port Mirroring with External RMON Probes

Port mirroring is a helpful monitoring tool when used in conjunction with an external RMON probe. Once you set up port mirroring, the probe can collect all relevant RMON statistics for traffic on the mirrored port. You can also move the mirrored port so that the mirroring port receives data from different ports. In this way, you can roam the switch and monitor traffic at various ports.

Note. If the mirroring port monitors mirrored traffic on an RMON probe belonging to a different VLAN than the mirrored port, it must be protected from blocking due to Spanning Tree updates. See [“Unblocking Ports \(Protection from Spanning Tree\)”](#) on page 35-18 for details.

The diagram on the following page illustrates how port mirroring can be used with an external RMON probe to copy RMON probe frames and Management frames to and from the mirroring and mirrored ports. Frames received from an RMON probe attached to the mirroring port can be seen as being received

by the mirrored port. These frames from the mirroring port are marked as if they are received on the mirrored port before being sent over the switch backplane to an NMS station. Therefore, management frames destined for the RMON probe are first forwarded out of the mirrored port. After being received on the mirrored port, copies of the frames are mirrored out of the mirroring port—the probe attached to the mirroring port receives the management frames.

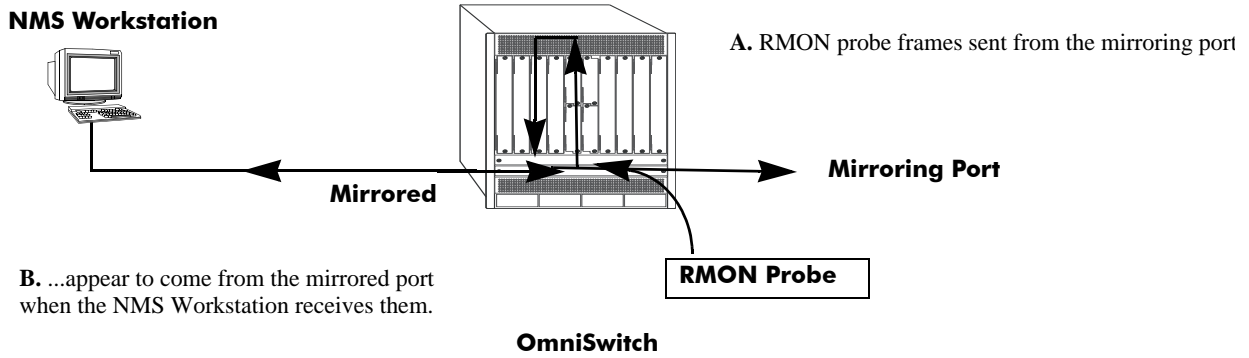

C. Management frames from the NMS Workstation are sent to the mirrored port...

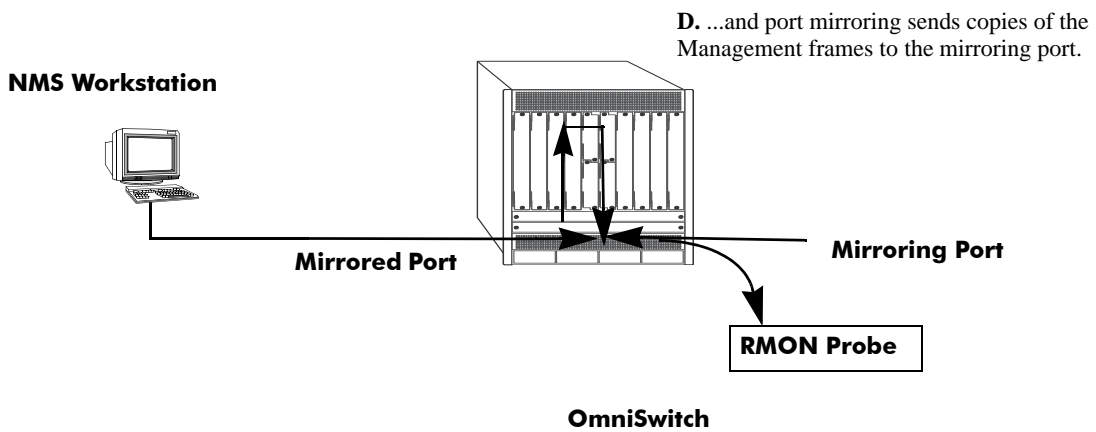

Port Mirroring Using External RMON Probe

Remote Port Mirroring

Remote Port Mirroring expands the port mirroring functionality by allowing mirrored traffic to be carried over the network to a remote switch. With Remote Port Mirroring the traffic is carried over the network using a dedicated Remote Port Mirroring VLAN, no other traffic is allowed on this VLAN. The mirrored traffic from the source switch is tagged with the VLAN ID of the Remote Port Mirroring VLAN and forwarded over the intermediate switch ports to the destination switch where an analyzer is attached.

Since Remote Port Mirroring requires traffic to be carried over the network, the following exceptions to regular port mirroring exist:

- Spanning Tree must be disabled for the Remote Port Mirroring VLAN on all switches.
- There must not be any physical loop present in the Remote Port Mirroring VLAN.
- Remote port mirroring (RPMIR) MTP port can have tagged VLAN and untagged default VLAN on it.
- The VLAN ID used for RPMIR cannot be assigned to the MTP port.
- The VLAN ID used for RPMIR cannot be assigned to the unblocked VLAN.
- On the intermediate and destination switches, source learning must be disabled or overridden on the ports belonging to the Remote Port Mirroring VLAN.
- The **mac-learning vlan disable** command can be used to override source learning on an OmniSwitch.

The following types of traffic are not mirrored:

- Link Aggregation Control Packets (LACP)
- 802.1AB (LLDP)
- 802.1x port authentication
- 802.3ag (OAM)
- Layer 3 control packets
- Generic Attribute Registration Protocol (GARP)

For more information and an example of a Remote Port Mirroring configuration, see [“Remote Port Mirroring” on page 35-17](#).

Creating a Mirroring Session

Before port mirroring can be used, it is necessary to create a port mirroring session. The **port-mirroring source destination** CLI command can be used to create a mirroring session between a mirrored (active) port and a mirroring port.

To create a mirroring session, enter the **port-mirroring source destination** command and include the port mirroring session ID number and the source and destination ports as shown in the following example:

```
-> port-mirroring 6 source 2/1/3 destination 2/1/4
```

To create a remote port mirroring session, enter the **port-mirroring source destination** command and include the port mirroring session ID number, the source and destination ports, and the remote port mirroring VLAN ID as shown in the following example:

```
-> port-mirroring 8 source 1/1/1 destination 1/1/2 rpmir-vlan 1000
```

This command line specifies remote port mirroring session 8, with the source (mirrored) port located on port 1/1/1, the destination (mirroring) port 1/1/2, and the remote port mirroring VLAN 1000.

Creating an “N-to-1” port mirroring session is supported where multiple source ports can be mirrored to a single destination port as in the following example:

```
-> port-mirroring 1 source 1/1/2 destination 2/1/4
-> port-mirroring 1 source 2/1/1 destination 2/1/4
-> port-mirroring 1 source 2/1/3 destination 2/1/4
```

As an option, you can specify a range of source ports and/or multiple source ports as in the following example:

```
-> port-mirroring 1 source 1/1/2-6 destination 2/1/4
```

In the following example, ports 1/9, 2/7, and 3/5 are mirrored on destination port 2/4 in session 1:

```
-> port-mirroring 1 source 1/1/9 2/1/7 3/1/5 destination 2/1/4
-> port-mirroring 1 source 1/1/2-6 1/1/9 2/1/7 3/1/5 destination 2/1/4
```

Note. Ports can be added after a port mirroring session has been configured.

Unblocking Ports (Protection from Spanning Tree)

Spanning tree is disabled by default on an MTP port. When unblocked VLAN is configured, the VLAN ID specified is assigned to the MTP port as the default VLAN. Hence allowing inbound traffic and handling traffic for that VLAN ID. Spanning tree remains disabled. To create a mirroring session that protects the mirroring port from being blocked (*default*), enter the **port-mirroring source destination** CLI command and include the port mirroring session ID number, source and destination ports, and unblocked VLAN ID number, as shown in the following example:

```
-> port-mirroring 6 source 2/1/3 destination 2/1/4 unblocked-vlan 750
```

Enabling or Disabling Mirroring Status

Mirroring Status is the parameter using which you can enable or disable a mirroring session (i.e., turn port mirroring on or off). There are two ways to do this:

- *Creating a Mirroring Session and Enabling Mirroring Status or Disabling a Mirroring Session (Disabling Mirroring Status).* These procedures are described below and on the following page.
- *Enabling or Disabling a Port Mirroring Session*—“shorthand” versions of the above commands that require fewer keystrokes. Only the port mirroring session ID number needs to be specified, rather than the entire original command line syntax (for example, source and destination ports and optional unblocked VLAN ID number). See “[Enabling or Disabling a Port Mirroring Session \(Shorthand\)](#)” on [page 35-20](#) for details.

Disabling a Mirroring Session (Disabling Mirroring Status)

To disable the mirroring status of the configured session between a mirrored port and a mirroring port (turning port mirroring off), use the **port-mirroring source destination** CLI command. Be sure to include the port mirroring session ID number and the keyword **disable**.

In this example, the command specifies port mirroring session 6, with the mirrored (active) port located in port 3, and the mirroring port located in port 4. The mirroring status is disabled (i.e., port mirroring is turned off):

```
-> port-mirroring 6 source disable
```

Note. You can modify the parameters of a port mirroring session that has been disabled.

Keep in mind that the port mirroring session configuration remains valid, even though port mirroring has been turned off.

Note. The port mirroring session identifier and port locations of the designated interfaces must always be specified.

Configuring Port Mirroring Direction

By default, port mirroring sessions are bidirectional. To configure the direction of a port mirroring session between a mirrored port and a mirroring port, use the **port-mirroring source destination** CLI command by entering port mirroring, followed by the port mirroring session ID number, the source and destination ports, and **bidirectional**, **inport**, or **outport**.

Note. Optionally, you can also specify the optional unblocked VLAN ID number and either enable or disable on the same command line.

In this example, the command specifies port mirroring session 6 and the mirroring direction is unidirectional and inward bound:

```
-> port-mirroring 6 source 2/1/3 destination 6/1/4 inport
```

In this example, the command specifies port mirroring session 6 and the mirroring direction is unidirectional and outward bound:

```
-> port-mirroring 6 source 2/1/3 destination 6/1/4 outport
```

You can use the **bidirectional** keyword to restore a mirroring session to its default bidirectional configuration. For example:

```
-> port-mirroring 6 source 2/1/3 destination 6/1/4 bidirectional
```

Note. The port mirroring session identifier and port locations of the designated interfaces must always be specified.

Enabling or Disabling a Port Mirroring Session (Shorthand)

Once a port mirroring session configuration has been created, this command is useful for enabling or disabling it (turning port mirroring on or off) without having to re-enter the source and destination ports and unblocked VLAN ID command line parameters.

To enable a port mirroring session, enter the **port-mirroring** command, followed by the port mirroring session ID number and the keyword **enable**. The following command enables port mirroring session 6 (turning port mirroring on):

```
-> port-mirroring 6 enable
```

Note. Port mirroring session parameters cannot be modified when a mirroring session is enabled. Before you can modify parameters, the mirroring session must be disabled.

To disable a port mirroring session, enter the **port-mirroring** command, followed by the port mirroring session ID number and the keyword **disable**. The following command disables port mirroring session 6 (turning port mirroring off):

```
-> port-mirroring 6 disable
```

Displaying Port Mirroring Status

To display port mirroring status, use the **show port-mirroring status** command. To display all port mirroring sessions, enter:

```
-> show port-mirroring status 6
```

Session	Mirror Destination	Mirror Direction	Unblocked Vlan	Config Status	Oper Status
1.	2/1/1	-	NONE	Enable	On
	Mirror Source				
1.	1/1/1	bidirectional	-	Enable	On
1.	1/1/2	bidirectional	-	Enable	On
1.	1/1/3	bidirectional	-	Enable	On
1.	1/1/4	bidirectional	-	Enable	On
1.	1/5	bidirectional	-	Enable	On

Deleting A Mirroring Session

The **no** form of the **port-mirroring** command can be used to delete a previously created mirroring session configuration between a mirrored port and a mirroring port.

To delete a mirroring session, enter the **no port-mirroring** command, followed by the port mirroring session ID number. For example, the following command deletes port mirroring session 6:

```
-> no port-mirroring 6
```

Note. The port mirroring session identifier must always be specified.

Configuring Remote Port Mirroring

This section describes the steps required to configure Remote Port Mirroring between Source, Intermediate, and Destination switches.

The following diagram shows an example of a Remote Port Mirroring configuration:

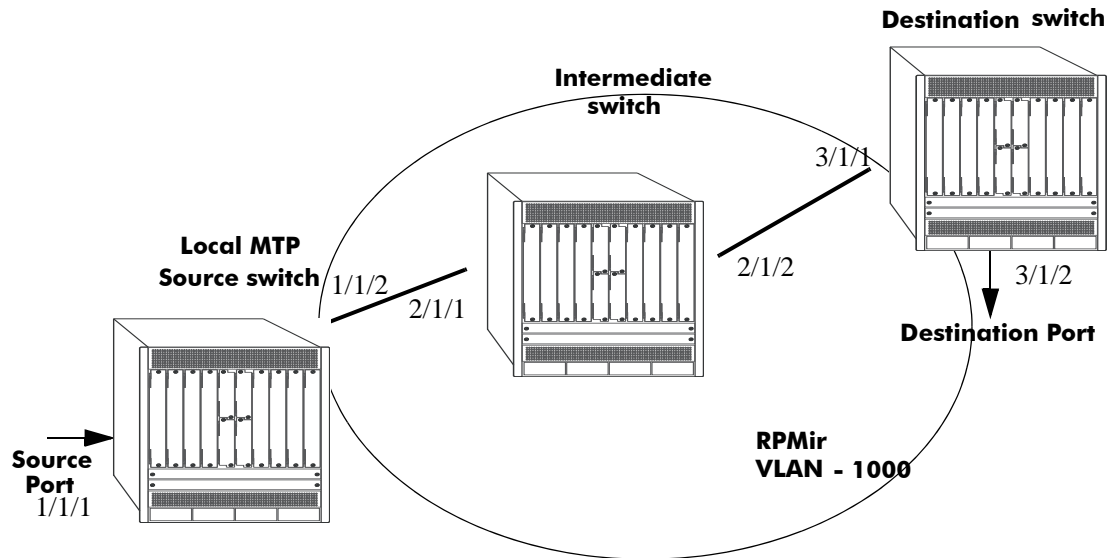

Remote Port Mirroring Example

Configuring Source Switch

Follow the steps given below to configure the Source Switch:

```
-> port-mirroring 8 source 1/1/1
-> port-mirroring 8 destination 1/1/2 rpmir-vlan 1000
```

Configuring Intermediate Switch

Follow the steps given below to configure all the Intermediate Switches:

```
-> vlan 1000
-> spantree vlan 1000 admin-state disable
-> vlan 1000 members port 2/1/1-2 tagged
```

Enter the following QoS commands to override source learning:

```
-> policy condition c_is1 source vlan 1000
-> mac-learning vlan 1000 disable
-> policy rule r_is1 condition c_is1 action a_is1
-> qos apply
```

Note. If the intermediate switches are not OmniSwitches, refer to the vendor documentation for instructions on disabling or overriding source learning.

Configuring Destination Switch

Follow the steps given below to configure the Destination Switch:

```
-> vlan 1000
-> spantree vlan 1000 admin-state disable
-> vlan 1000 members port 3/1/1-2 tagged
```

Enter the following QoS commands to override source learning:

```
-> policy condition c_ds1 source vlan 1000
-> mac-learning vlan 1000 disable
-> policy rule r_ds1 condition c_ds1 action a_ds1
-> qos apply
```

Port Monitoring

An essential tool of the network engineer is a network packet capture device. A packet capture device is usually a PC-based computer, such as the Sniffer[®], that provides a means for understanding and measuring data traffic of a network. Understanding data flow in a VLAN-based switch presents unique challenges, primarily because traffic moves inside the switch, especially on dedicated devices.

The port monitoring feature allows you to examine packets to and from a specific Ethernet port. Port monitoring has the following features:

- Software commands to enable and display captured port data.
- Captures data in Network General[®] file format.
- A file called **pmonitor.enc** is created in the **/flash** memory when you configure and enable a port monitoring session.
- Data packets time stamped.
- One port monitored at a time.
- RAM-based file system.
- Statistics gathering and display.

The port monitoring feature also has the following restrictions:

- All packets cannot be captured. (Estimated packet capture rate is around 500 packets/second.)
- The maximum number of monitoring sessions is limited to one per chassis.
- Only the first 64 bytes of the traffic is captured in 'brief' mode. If the monitoring capture-type is set to 'full' the entire packet is captured.
- Link Aggregation ports can be monitored.
- If both mirroring and monitoring are enabled, then packets is either mirrored *or* monitored (i.e., sent to CPU), whichever comes first. See [“Mirroring on Multiple Ports” on page 35-15](#) for more information.

You can select to dump real-time packets to a file. Once a file is captured, you can FTP it to a Sniffer or PC for viewing.

Configuring a Port Monitoring Session

To configure a port monitoring session, use the **port-monitoring source** command by entering **port - monitoring**, followed by the user-specified session ID number, **source**, and the port to be monitored. For example:

```
-> port-monitoring 6 source 2/1/3
```

Note. One port monitoring session can be configured per chassis.

In addition, you can also specify optional parameters shown in the table below. These parameters must be entered after the port number.

keywords

file	no file	size
no overwrite	inport	outport
bidirectional	timeout	enable
disable	capture-type	full
brief		

For example:

```
-> port-monitoring 6 source 2/1/3 enable
```

These keywords can be used when creating the port monitoring session or afterwards. See the sections below for more information on using these keywords.

Enabling a Port Monitoring Session

To enable a port monitoring session, use the **port-monitoring source** command by entering **port - monitoring**, followed by the user-specified session ID number, **source**, and the port number. For example: enter:

```
-> port-monitoring 6 source 2/1/3 enable
```

Disabling a Port Monitoring Session

To disable a port monitoring session, use the **port-monitoring** command by entering **port-monitoring**, followed by the port monitoring session ID and **pause**. For example, to disable port monitoring session 6, enter:

```
-> port-monitoring 6 disable
```

Deleting a Port Monitoring Session

To delete a port monitoring session, use the **no** form of the **port-monitoring** command by entering **no port-monitoring**, followed by the port monitoring session ID. For example, to delete port monitoring session 6, enter:

```
-> no port-monitoring 6
```

Pausing a Port Monitoring Session

To pause a port monitoring session, use the **port-monitoring** command by entering **port-monitoring**, followed by the port monitoring session ID and **pause**. For example, to pause port monitoring session 6, enter:

```
-> port-monitoring 6 pause
```

To resume a paused port monitoring session, use the **port-monitoring** command by entering **port-monitoring**, followed by the port monitoring session ID and **resume**. For example, to resume port monitoring session 6, enter:

```
-> port-monitoring 6 resume
```

Configuring Port Monitoring Session Persistence

By default, a port monitoring session is enabled. To modify the length of time before a port monitoring session is disabled from 0 (the default, where the session is permanent) to 2147483647 seconds, use the **port-monitoring source** CLI command. For example:

```
-> port-monitoring 6 source 2/1/3 timeout 12000
```

Configuring a Port Monitoring Data File

By default, a file called **pmonitor.enc** is created in the **/flash** directory when you configure and enable a port monitoring session. This file can be FTPed for later analysis. To configure a user-specified file, use the **port-monitoring source** CLI command. The port monitoring sniffer file can be viewed using software such as wireShark or ethereal. For example:

```
-> port-monitoring 6 source 2/1/3 file /flash/user_port
```

Optionally, you can also configure the size of the file and/or you can configure the data file so that more-recent packets does not overwrite older packets in the data file if the file size is exceeded.

To create a file and configure its size, use the **port-monitoring source** CLI command, **file**, the name of the file, **size**, and the size of the file in 16K byte increments. For example:

```
-> port-monitoring 6 source 2/1/3 file /flash/user_port size 3
```

To select the the type of port monitoring information captured, use the **port-monitoring source** CLI command by entering **port-monitoring**, followed by the user-specified session ID number, **source**, the port to be monitored, a slash (/), the port number of the port, **file**, the name of the file, and the **capture-type** keyword followed by the keywords, **full** or **brief**. For example:

```
-> port-monitoring 6 source 2/1/3 file /flash/user_port capture-type full
```

To prevent more recent packets from overwriting older packets in the data file, if the file size is exceeded, use the **port-monitoring source** CLI command, **file**, the name of the file, and **overwrite off**. For example:

```
-> port-monitoring 6 source 2/1/3 file user_port overwrite off
```

To allow more recent packets from overwriting older packets in the data file if the file size is exceeded (the default), use the **port-monitoring source** CLI command, **file**, the name of the file, and **overwrite on**.

For example:

```
-> port-monitoring 6 source 2/1/3 file /flash/user_port overwrite on
```

Note. The **size** and **no overwrite** options can be entered on the same command line.

Configuring Port Monitoring Direction

By default, port monitoring sessions are bidirectional. To configure the direction of a port mirroring session between a mirrored port and a mirroring port, use the **port-monitoring source** CLI command and **inport**, **outport**, or **bidirectional**. For example:

```
-> port-monitoring 6 source 2/1/3 inport
-> port-monitoring 6 source 2/3 outport
-> port-monitoring 6 source 2/3 bidirectional
```

Configuring Capture Type

To configure the amount of data to be captured, use the **port-monitoring source capture-type** command. If the mode of capture-type is set to 'brief', only the first 64 bytes of packets will be captured. If the mode of capture-type is set to 'full', then the full packet is captured regardless of the packet size. For example:

```
-> port-monitoring 6 source 2/1/3 capture-type brief
-> port-monitoring 6 source 2/1/3 capture-type full
```

Displaying Port Monitoring Status and Data

A summary of the show commands used for displaying port monitoring status and port monitoring data is given here:

show port-monitoring status Displays port monitoring status.

show port-monitoring file Displays port monitoring data.

For example, use the **show port-monitoring file** command to display port monitoring data:

```
-> show port-monitoring file
```

Destination	Source	Type	Data
01:80:C2:00:00:00	00:20:DA:8F:92:C6	BPDU	00:26:42:42:03:00:00:00:00:00
00:20:DA:C7:2D:D6	08:00:20:95:F3:89	UDP	08:00:45:00:00:6B:FE:4A:40:00
00:20:DA:A3:89:F6	08:00:20:95:F3:89	UDP	08:00:45:00:00:6B:CF:89:40:00
00:20:DA:BF:5B:76	08:00:20:95:F3:89	UDP	08:00:45:00:00:6B:CF:85:40:00
00:20:DA:A3:89:F6	08:00:20:95:F3:89	UDP	08:00:45:00:00:6B:CF:8A:40:00
00:20:DA:BF:5B:76	08:00:20:95:F3:89	UDP	08:00:45:00:00:6B:CF:86:40:00
00:20:DA:A3:89:F6	08:00:20:95:F3:89	UDP	08:00:45:00:00:6B:CF:8B:40:00
01:80:C2:00:00:00	00:20:DA:8F:92:C6	BPDU	00:26:42:42:03:00:00:00:00:00
00:20:DA:BF:5B:76	08:00:20:95:F3:89	UDP	08:00:45:00:00:6B:CF:87:40:00

For more information about the displays that result from these commands, see the *OmniSwitch AOS Release 8 CLI Reference Guide*. The **show port-monitoring** command displays only 170 packets from the port monitor file.

sFlow

sFlow is a network monitoring technology that gives visibility in to the activity of the network, by providing network usage information. It provides the data required to effectively control and manage the network usage. sFlow is a sampling technology that meets the requirements for a network traffic monitoring solution.

sFlow is an industry standard with many vendors delivering products with this support. Some of the applications of the sFlow data include:

- Detecting, diagnosing, and fixing network problems
- Real-time congestion management
- Detecting unauthorized network activity
- Usage accounting and billing
- Understanding application mix
- Route profiling and peer optimization
- Capacity planning

sFlow is a sampling technology embedded within switches/routers. It provides the ability to monitor the traffic flows. It requires a sFlow agent software process running as part of the switch software and a sFlow collector which receives and analyses the monitored data. The sFlow collector makes use of SNMP to communicate with a sFlow agent in order to configure sFlow monitoring on the device (switch).

sFlow agent running on the switch/router, combines interface counters and traffic flow (packet) samples preferably on all the interfaces into sFlow datagrams that are sent across the network to an sFlow collector.

Packet sampling on the switch/router is typically performed by the switching/routing ASICs, providing wire-speed performance. In this case, sFlow agent does very little processing, by packaging data into sFlow datagrams that are immediately sent on network. This minimizes the memory and CPU utilization by sFlow agent.

sFlow Manager

The sFlow manager is the controller for all the modules. It initializes all other modules. It interfaces with the Ethernet driver to get the counter samples periodically and reads sampled packets. The counter samples are given to the poller and sampled packets are given to the sampler to format a UDP packet.

Each sFlow manager instance has multiples of receiver, sampler, and poller instances. Each user programmed port has an individual sampler and poller. The sampler and poller could be potentially pointing to multiple receivers if the user has configured multiple destination hosts.

Receiver

The receiver module has the details about the destination hosts where the sFlow datagrams are sent out. If there are multiple destinations then each destination has an instance of the receiver. All these receivers are attached to the sFlow manager instance and to an associated sample/poller.

Sampler

The sampler is the module which gathers samples and fills up the sampler part of the UDP datagram.

Poller

The poller is the module which gets counter samples from Ethernet driver and fills up the counter part of the UDP datagram.

Configuring an sFlow Session

To configure a sFlow receiver session, use the **sflow receiver** command by entering **sflow receiver**, followed by the receiver_index, name, the name of the session and **address**, and the IP address of the receiver.

For example, to configure receiver session 6 on switch 10.255.11.28, enter:

```
-> sflow receiver 6 name sflowtrend address 10.255.11.28
```

In addition, you can also specify optional parameters shown in the table below. These parameters can be entered after the IP address.

keywords

timeout	packet-size
forever	version
udp-port	

For example, to configure sFlow receiver session 6 on switch 10.255.11.28 and to specify the packet-size and timeout value, enter:

```
-> sflow receiver 6 name sflowtrend address 10.255.11.28 packet-size 1400
timeout 600
```

To configure a sFlow sampler session, use the **sflow sampler** command by entering **sflow sampler**, followed by the instance ID number, the port to be monitored, a slash (/), and the port number and **receiver**, the receiver_index.

For example, to configure sampler session 1 on port 2/3, enter:

```
-> sflow sampler 1 port 2/3 receiver 6
```

In addition, you can also specify optional parameters shown in the table below. These parameters can be entered after the receiver index.

keywords

rate
sample-hdr-size

For example:

```
-> sflow sampler 1 port 2/1/3 receiver 6 rate 512 sample-hdr-size 128
```

To configure a sFlow poller session, use the **sflow poller** command. For example:

```
-> sflow poller 3 port 1/1/1 receiver 6
```

In addition, you can also specify the optional **interval** parameter after the receiver index value. For example:

```
-> sflow poller 3 port 1/1/1 receiver 6 interval 5
```

Configuring a Fixed Primary Address

In order to generate the IP packets and send the sFlow datagrams out into the network, configure an IP address for the sFlow agent using the **ip service source-ip** command. If there is no IP address configured, then the sFlow datagrams will not be sent to the receiver.

For example, to configure the agent IP address, enter:

```
-> ip service source-ip ipVlan100 sflow
```

In this example, “ipVlan100” is the name of the IP interface that will serve as the IP address for the sFlow agent.

Displaying an sFlow Receiver

The **show sflow receiver** command is used to display the receiver table.

For example, to view the sFlow receiver table, enter the **show sflow receiver** command without specifying any additional parameters. A screen similar to the following example is displayed, as shown below:

```
-> show sflow receiver

Receiver 1
Name      = Golden
Address   = IP_V4 198.206.181.3
UDP Port  = 6343
Timeout   = 65535
Packet Size= 1400
DatagramVer= 5
```

For more information about the displays that result from these commands, see the *OmniSwitch AOS Release 8 CLI Reference Guide*.

Displaying an sFlow Sampler

The **show sflow sampler** command is used to display the sampler table.

For example, to view the sFlow sampler table, enter the **show sflow sampler** command without specifying any additional parameters. A screen similar to the following example is displayed, as shown below:

```
-> show sflow sampler

Instance  Interface  Receiver  Sample-rate  Sample-hdr-size
-----
1         2/1/1      1         2048         128
1         2/1/2      1         2048         128
1         2/1/3      1         2048         128
1         2/1/4      1         2048         128
1         2/1/5      1         2048         128
```

For more information about the displays that result from these commands, see the *OmniSwitch AOS Release 8 CLI Reference Guide*.

Displaying an sFlow Poller

The **show sflow poller** command is used to display the poller table.

For example, to view the sFlow poller table, enter the **show sflow poller** command without specifying any additional parameters. A screen similar to the following example is displayed, as shown below:

```
-> show sflow poller

Instance Interface      Receiver Interval
-----
1          2/1/6                1          30
1          2/1/7                1          30
1          2/1/8                1          30
1          2/1/9                1          30
1          2/1/10               1          30
```

For more information about the displays that result from these commands, see the *OmniSwitch AOS Release 8 CLI Reference Guide*.

Displaying an sFlow Agent

The **show sflow agent** command is used to display the receiver table.

For example, to view the sFlow agent table, enter the **show sflow agent** command without specifying any additional parameters. A screen similar to the following example is displayed, as shown below:

```
-> show sflow agent

Agent Version = 1.3; Alcatel-Lucent; 6.1.1
Agent IP      = 127.0.0.1
```

For more information about the displays that result from these commands, see the *OmniSwitch AOS Release 8 CLI Reference Guide*.

Deleting an sFlow Session

To delete a sFlow receiver session, use the release form at the end of the **sflow receiver** command. For example:

```
-> sflow receiver 6 release
```

To delete a sFlow sampler session, use the no form of the **sflow sampler** command. For example:

```
-> no sflow sampler 1 port 2/1/3
```

To delete a sFlow poller session, use the no form of the **sflow poller** command. For example:

```
-> no sflow poller 3 port 1/1/1
```

Remote Monitoring (RMON)

Remote Network Monitoring (RMON) is an SNMP protocol used to manage networks remotely. *RMON probes* can be used to collect, interpret, and forward statistical data about network traffic from designated active ports in a LAN segment to an NMS (Network Management System) application for monitoring and analysis without negatively impacting network performance. RMON software is fully integrated in the Chassis Management software and works with the Ethernet software to acquire statistical information. However, it does not monitor the CMM module's onboard Ethernet Management port on OmniSwitch chassis-based switches (which is reserved for management purposes).

The following diagram illustrates how an External RMON probe can be used with port mirroring to copy RMON probe frames and Management frames to and from the mirroring and mirrored ports. Frames received from an RMON probe attached to the mirroring port can be seen as being received by the mirrored port. These frames from the mirroring port are marked as if they are received on the mirrored port before being sent over the switch backplane to an NMS station. Therefore, management frames that are destined for the RMON probe are first forwarded out of the mirrored port. After being received on the mirrored port, copies of the frames are mirrored out of the mirroring port—the probe attached to the mirroring port receives the management frames.

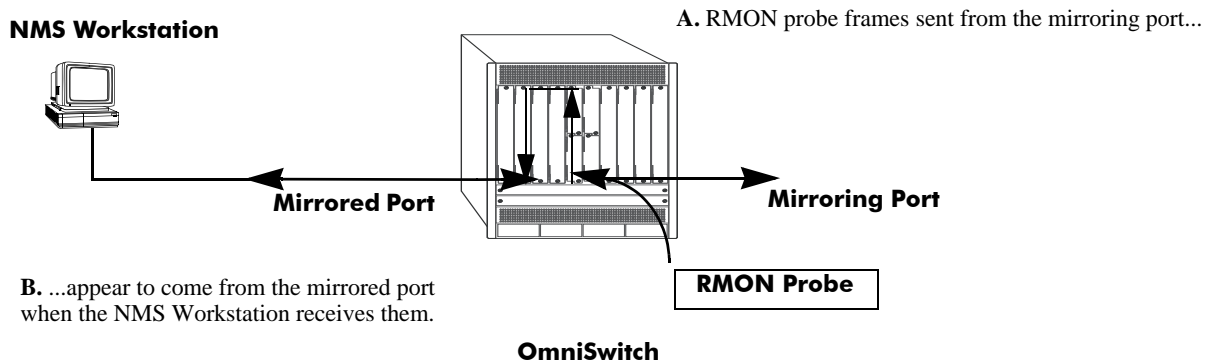

C. Management frames from the NMS Workstation are sent to the mirrored port...

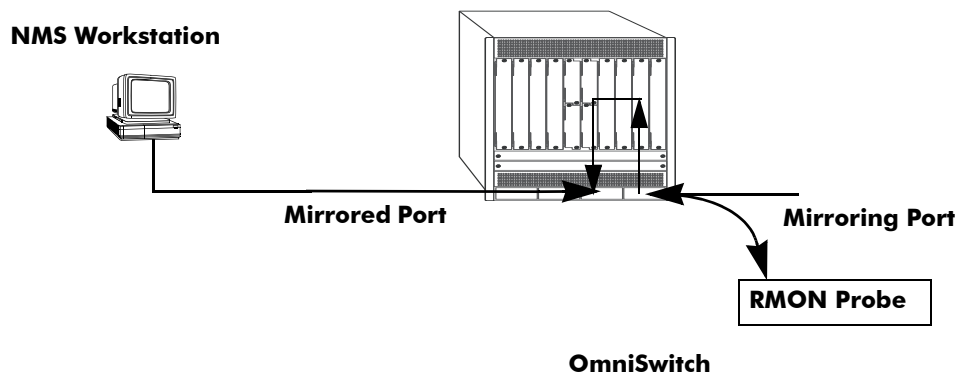

D. ...and port mirroring sends copies of the Management frames to the mirroring port.

Port Mirroring Using External RMON Probe

RMON probes can be enabled or disabled through CLI commands. Configuration of Alarm threshold values for RMON traps is a function reserved for RMON-monitoring NMS stations.

This feature supports basic RMON 4 group implementation in compliance with RFC 2819, including the **Ethernet Statistics**, **History** (Control & Statistics), **Alarms** and **Events** groups (*described below*).

Note. RMON 10 group and RMON2 are not implemented in the current release. An external RMON probe that includes RMON 10 group and RMON2 be used where full RMON probe functionality is required.

Ethernet Statistics

Ethernet statistics probes are created whenever new ports are inserted and activated in the chassis. When a port is removed from the chassis or deactivated, the Ethernet statistics group entry associated with the physical port is invalidated and the probe is deleted.

The Ethernet statistics group includes port utilization and error statistics measured by the RMON probe for each monitored Ethernet interface on the switch. Examples of these statistics include CRC (Cyclic Redundancy Check)/alignment, undersized/oversized packets, fragments, broadcast/multicast/unicast, and bandwidth utilization statistics.

History (Control & Statistics)

The History (Control & Statistics) group controls and stores periodic statistical samplings of data from various types of networks. Examples include Utilization, Error Count, and Frame Count statistics.

Alarm

The Alarm group collects periodic statistical samples from variables in the probe and compares them to previously configured thresholds. If a sample crosses a previously configured threshold value, an Event is generated. Examples include Absolute or Relative Values, Rising or Falling Thresholds on the Utilization Frame Count and CRC Errors.

Event

The Event group controls generation and notification of events from the switch to NMS stations. For example, customized reports based on the type of Alarm can be generated, printed and/or logged.

Note. The following RMON groups are not implemented: **Host**, **HostTopN**, **Matrix**, **Filter**, and **Packet Capture**.

Enabling or Disabling RMON Probes

To enable or disable an individual RMON probe, enter the **rmon probes** CLI command. Be sure to specify the type of probe (**stats/history/alarm**), followed by the entry number (optional), as shown in the following examples.

The following command enables RMON Ethernet Statistics probe number 4012:

```
-> rmon probes stats 4012 enable
```

The following command disables RMON History probe number 10240:

```
-> rmon probes history 10240 disable
```

The following command enables RMON Alarm probe number 11235:

```
-> rmon probes alarm 11235 enable
```

To enable or disable an entire group of RMON probes of a particular flavor type (such as Ethernet Statistics, History, or Alarm), enter the command **without** specifying an *entry-number*, as shown in the following examples.

The following command disables all currently defined (disabled) RMON Ethernet Statistics probes:

```
-> rmon probes stats disable
```

The following command enables all currently defined (disabled) RMON History probes:

```
-> rmon probes history enable
```

The following command enables all currently defined (disabled) RMON Alarm probes:

```
-> rmon probes alarm enable
```

Note. Network activity on subnetworks attached to an RMON probe can be monitored by Network Management Software (NMS) applications.

Displaying RMON Tables

Two separate commands can be used to retrieve and view Remote Monitoring data: **show rmon probes** and **show rmon events**. The retrieved statistics appear in a *table* format (a collection of related data that meets the criteria specified in the command you entered). These RMON tables can display the following kinds of data (depending on the criteria you've specified):

- The **show rmon probes** command can display a list of current RMON probes or statistics for a particular RMON probe.
- The **show rmon events** command can display a list of RMON events (actions that occur in response to Alarm conditions detected by an RMON probe) or statistics for a particular RMON event.

Displaying a List of RMON Probes

To view a list of current RMON probes, enter the **show rmon probes** command with the probe type, without specifying an entry number for a particular probe.

For example, to show a list of the statistics probes, enter:

```
-> show rmon probes stats
```

A display showing all current statistics RMON probes must appear, as shown in the following example:

Entry	Chas/Slot/Port	Flavor	Status	Duration	System Resources
4001	4/1/1	Ethernet	Active	00:25:00	275 bytes
4008	4/1/8	Ethernet	Active	00:25:00	275 bytes
4005	4/1/5	Ethernet	Active	00:25:00	275 bytes

This table entry displays probe statistics for all probes on the switch. The probes are active, utilize 275 bytes of memory, and 25 minutes have elapsed since the last change in status occurred.

To show a list of the history probes, enter:

```
-> show rmon probes history
```

A display showing all current history RMON probes must appear, as shown in the following example:

Entry	Chas/Slot/Port	Flavor	Status	Duration	System Resources
1	1/1/1	History	Active	92:52:20	5464 bytes
30562	1/1/35	History	Active	00:31:22	312236 bytes
30817	1/1/47	History	Active	00:07:31	5200236 bytes

The table entry displays statistics for RMON History probes on the switch.

To show a list of the alarm probes, enter:

```
-> show rmon probes alarm
```

A display showing all current alarm RMON probes must appear, as shown in the following example:

Entry	Chas/Slot/Port	Flavor	Status	Duration	System Resources
31927	1/1/35	Alarm	Active	00:25:51	608 bytes

Displaying Statistics for a Particular RMON Probe

To view statistics for a particular current RMON probe, enter the `show rmon probes` command, specifying an entry number for a particular probe, such as:

```
-> show rmon probes 4005
```

A display showing statistics for the specified RMON probe appears, as shown in the following sections.

Sample Display for Ethernet Statistics Probe

The display shown here identifies RMON Probe 4005's Owner description and interface location (OmniSwitch Auto Probe on port 5), Entry number (4005), probe Flavor (Ethernet statistics), and Status (Active). Additionally, the display indicates the amount of time that has elapsed since the last change in status (48 hours, 54 minutes), and the amount of memory allocated to the probe, measured in bytes (275).

```
-> show rmon probes 4005
```

```
Probe's Owner: Switch Auto Probe on Chassis 4 Slot 1, Port 5
Entry 4005
Flavor = Ethernet, Status = Active
Time = 48 hrs 54 mins,

System Resources (bytes) = 275
```

Sample Display for History Probe

The display shown here identifies RMON Probe 10325's Owner description and interface location (Analyzer-p:128.251.18.166 on port 35), the total number of History Control Buckets (samples) requested and granted (2), along with the time interval for each sample (30 seconds) and system-generated Sample Index ID number (5859). The probe Entry number identifier (10325), probe Flavor (History), and Status (Active), the amount of time that has elapsed since the last change in status (48 hours, 53 minutes), and the amount of memory allocated to the probe, measured in bytes (601) are also displayed.

```
-> show rmon probes history 30562
```

```
Probe's Owner: Analyzer-p:128.251.18.166 on Chassis 1, Slot 1, Port 35
```

```
History Control Buckets Requested    = 2
History Control Buckets Granted      = 2
History Control Interval              = 30 seconds
History Sample Index                 = 5859
Entry 10325
  Flavor = History, Status = Active
  Time = 48 hrs 53 mins,
  System Resources (bytes) = 601
```

Sample Display for Alarm Probe

The display shown here identifies RMON Probe 11235's Owner description and interface location (Analyzer-t:128.251.18.166 on port 35), as well as the Alarm Rising Threshold of the probe and Alarm Falling Threshold, maximum allowable values beyond which an alarm is generated and sent to the Event group (5 and 0, respectively).

Additionally, the corresponding Alarm Rising Event Index number (26020) and Alarm Falling Event Index number (0), which link the Rising Threshold Alarm and Falling Threshold Alarm to events in the Event table, are identified. The Alarm Interval, a time period during which data is sampled (10 seconds) and Alarm Sample Type (delta value—variable) are also shown, as is the Alarm Variable ID number (1.3.6.1.2.1.16.1.1.1.5.4008). The probe Entry number identifier (11235), probe Flavor (Alarm), Status (Active), the amount of time that has elapsed since the last change in status (48 hours, 48 minutes), and the amount of memory allocated to the probe, measured in bytes (1677) are also displayed.

```
-> show rmon probes alarm 31927
```

```
Probe's Owner: Analyzer-t:128.251.18.166 on Chassis 1, Slot 1, Port 35
```

```
Alarm Rising Threshold    = 5
Alarm Falling Threshold    = 0
Alarm Rising Event Index  = 26020
Alarm Falling Event Index = 0
Alarm Interval            = 10 seconds
Alarm Sample Type         = delta value
Alarm Startup Alarm       = rising alarm
Alarm Variable            = 1.3.6.1.2.1.16.1.1.1.5.4008
Entry 11235
  Flavor = Alarm, Status = Active
  Time = 48 hrs 48 mins,
  System Resources (bytes) = 1677
```

Displaying a List of RMON Events

RMON Events are actions that occur based on Alarm conditions detected by an RMON probe. To view a list of logged RMON Events, enter the **show rmon events** command without specifying an entry number for a particular probe, such as:

```
-> show rmon events
```

A display showing all logged RMON Events must appear, as shown in the following example:

Entry	Time	Description
1	00:08:00	etherStatsPkts.4008: [Falling trap] "Falling Event"
2	00:26:00	etherStatsCollisions.2008: "Rising Event"
3	00:39:00	etherStatsCollisions.2008: "Rising Event"

The display shown above identifies the Entry number of the specified Event, along with the elapsed time since the last change in status (measured in hours/minutes/seconds) and a description of the Alarm condition detected by the probe for all RMON Logged Events. For example, Entry number 3 is linked to etherStatsCollisions.2008: [Rising trap] "Rising Event," an Alarm condition detected by the RMON probe in which a trap was generated based on a Rising Threshold Alarm, with an elapsed time of 39 minutes since the last change in status.

Displaying a Specific RMON Event

To view information for a specific logged RMON Event, enter the **show rmon events** command, specifying an entry number (event number) for a particular probe, such as:

```
-> show rmon events 3
```

A display showing the specific logged RMON Event must appear, as shown in the following example:

Entry	Time	Description
3	00:39:00	etherStatsCollisions.2008: "Rising Event"

The display shown above identifies the Entry number of the specified Event, along with the elapsed time since the last change in status (measured in hours/minutes/seconds) and a description of the Alarm condition detected by the probe for the specific RMON Logged Event. For example, Entry number 3 is linked to etherStatsCollisions.2008: [Rising trap] "Rising Event," an Alarm condition detected by the RMON probe in which a trap was generated based on a Rising Threshold Alarm, with an elapsed time of 39 minutes since the last change in status.

Monitoring Switch Health

To monitor resource availability, the NMS (Network Management System) needs to collect significant amounts of data from each switch. As the number of ports per switch (and the number of switches) increases, the volume of data can become overwhelming. The Health Monitoring feature can identify and monitor a switch's resource utilization levels and thresholds, improving efficiency in data collection.

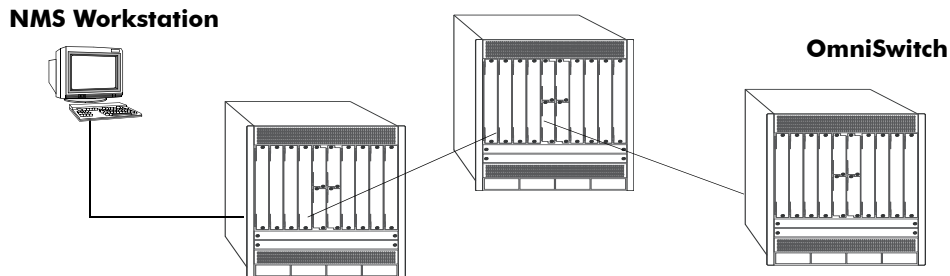

Monitoring Resource Availability from Multiple Ports and Switches

Health Monitoring provides the following data to the NMS:

- Switch-level Input/Output, Memory and CPU Utilization Levels
- Module-level and Port-level Input/Output Utilization Levels

For each monitored resource, the following variables are defined:

- Most recent utilization level (percentage)
- Average utilization level over the last minute (percentage)
- Average utilization level over the last hour (percentage)
- Maximum utilization level over the last hour (percentage)
- Threshold level

Additionally, Health Monitoring provides the capacity to specify thresholds for the resource utilization levels it monitors and generates traps based on the specified threshold criteria.

The following sections include a discussion of CLI commands that can be used to configure resource parameters and monitor or reset statistics for switch resources. These commands include:

- **health threshold**—Configures threshold limits for input traffic (RX), output/input traffic (TX/RX), memory usage, CPU usage, and chassis temperature. See [page 35-38](#) for more information.
- **show health configuration**—Displays current health threshold settings. See [page 35-39](#) for details.
- **health interval**—Configures sampling interval between health statistics checks. See [page 35-39](#) for more information..
- **show health** —Displays health statistics for the switch, as percentages of total resource capacity. See [page 35-40](#) for more information.

Configuring Resource Thresholds

Health Monitoring software monitors threshold levels for the switch's consumable resources—*bandwidth, RAM memory, and CPU capacity*. When a threshold is exceeded, the Health Monitoring feature sends a trap to the Network Management Station (NMS). A trap is an alarm alerting the user to specific network events. In the case of health-related traps, a specific indication is given to determine which threshold has been crossed.

Note. When a resource falls back below the configured threshold, an additional trap is sent to the user. This indicates that the resource is no longer operating beyond its configured threshold limit.

The **health threshold** command is used to configure threshold limits for input traffic (RX), output/input traffic (TX/RX), memory usage and CPU usage.

To configure thresholds for these resources, enter the **health threshold** command, followed by the input traffic, output/input traffic, memory usage, or CPU usage where:

rx	Specifies an input traffic (RX) threshold, in percentage. This value defines the maximum percentage of total bandwidth allowed for <i>incoming traffic only</i> . The total bandwidth is the Ethernet port capacity of <i>all NI modules</i> currently operating in the switch, in Mbps. For example, a chassis with 48 100Base-T Ethernet ports installed has a total bandwidth of 4800 Mbps. Since the default RX threshold is 80 percent, the threshold is exceeded if the input traffic on all ports reaches 3840 Mbps or higher.
txrx	Specifies a value for the output/input traffic (TX/RX) threshold. This value defines the maximum percentage of total bandwidth allowed for <i>all incoming and outgoing traffic</i> . As with the RX threshold described above, the total bandwidth is defined as the Ethernet port capacity for all NI modules currently operating in the switch, in Mbps. The default TX/RX threshold is 80 percent.
memory	Specifies a value for the memory usage threshold. Memory usage refers to the total amount of RAM memory currently used by switch applications. The default memory usage threshold is 80 percent.
cpu	Specifies a value for the CPU usage threshold. CPU usage refers to the total amount of CPU processor capacity currently used by switch applications. The default CPU usage threshold is 80 percent.

For example, to specify a CPU usage threshold of 85 percent, enter the following command:

```
-> health threshold cpu 85
```

For more information on the **health threshold** command, refer to [Chapter 44, “Health Monitoring Commands,”](#) in the *OmniSwitch AOS Release 8 CLI Reference Guide*.

Note. When you specify a new value for a threshold limit, the value is automatically applied across all levels of the switch (switch, module, and port). You cannot select differing values for each level.

Displaying Health Threshold Limits

The **show health configuration** command is used to view all current health thresholds on the switch, as well as individual thresholds for input traffic (RX), output/input traffic (TX/RX), memory usage and CPU usage.

To view all health thresholds, enter the following command:

```
-> show health configuration
Rx Threshold           = 80,
TxRx Threshold         = 80,
Memory Threshold       = 80,
CPU Threshold          = 80,
Sampling Interval (Secs) = 10
```

Note. For detailed definitions of each of the threshold types, refer to “[Configuring Resource Thresholds](#)” on page 35-38, as well as [Chapter 44, “Health Monitoring Commands,”](#) in the *OmniSwitch AOS Release 8 CLI Reference Guide*.

Configuring Sampling Intervals

The **sampling interval** is the period of time between polls of the switch’s consumable resources to monitor performance vis-a-vis previously specified thresholds. The **health interval** command can be used to configure the sampling interval between health statistics checks.

To configure the sampling interval, enter the **health interval** command, followed by the number of seconds.

For example, to specify a **sampling interval** value of 6 seconds, enter the following command:

```
-> health interval 6
```

Valid values for the seconds parameter include 1, 2, 3, 4, 5, 6, 10, 12, 15, 20, or 30.

Note. If the sampling interval is decreased, switch performance be affected.

Viewing Sampling Intervals

The **show health** command can be used to display the current health sampling interval (period of time between health statistics checks), measured in seconds.

To view the sampling interval, enter the **show health configuration** command. The currently configured health sampling interval (measured in seconds) is displayed, as shown below:

```
-> show health configuration

Rx Threshold           = 80,
TxRx Threshold         = 80,
Memory Threshold       = 80,
CPU Threshold          = 80,
Sampling Interval (Secs) = 10
```

Viewing Health Statistics for the Switch

The **show health** command can be used to display health statistics for the switch.

To display health statistics, enter the **show health** command, followed by the port location.

For example, to view health statistics for the entire switch, enter the **show health** command without specifying any additional parameters. A screen similar to the following example is displayed, as shown below:

```
-> show health
CMM                Current    1 Min    1 Hr    1 Day
Resources          Avg      Avg      Avg
-----+-----+-----+-----+
CPU                8        7        7        0
Memory            56       56       56       0
```

Viewing Health Statistics for a Specific Interface

To view health statistics for port 1, enter the **show health** command, followed by the appropriate port number. A screen similar to the following example is displayed, as shown below:

```
-> show health port 1/1/1
Port 1/ 1/ 1      Current    1 Min    1 Hr    1 Day
Resources          Avg      Avg      Avg
-----+-----+-----+-----+
Receive           0         0         0         0
Receive/Transmit 0         0         0         0
```

36 Configuring VLAN Stacking

VLAN Stacking provides a mechanism to tunnel multiple customer VLANs (CVLAN) through a service provider network using one or more service provider VLANs (SVLAN) by way of 802.1Q double-tagging or VLAN Translation. This feature enables service providers to offer their customers Transparent LAN Services (TLS). This service is multipoint in nature so as to support multiple customer sites or networks distributed over the edges of a service provider network.

This implementation of VLAN Stacking offers the following functionality:

- Ingress bandwidth sharing across User Network Interface (UNI) ports.
- Ingress bandwidth rate limiting on a per UNI port, per CVLAN, or CVLAN per UNI port basis.
- CVLAN (inner) tag 802.1p-bit mapping to SVLAN (outer) tag 802.1p bit.
- CVLAN (inner) tag DSCP mapping to SVLAN (outer) tag 802.1p bit.
- Profiles for saving and applying traffic engineering parameter values.

In This Chapter

This chapter describes the basic components of VLAN Stacking and how to define a service-based or port-based configuration through the Command Line Interface (CLI). CLI commands are used in the configuration examples; for more details about the syntax of commands, see the *OmniSwitch AOS Release 8 CLI Reference Guide*.

This chapter provides an overview of VLAN Stacking and includes the following topics:

- [“VLAN Stacking Specifications” on page 36-2.](#)
- [“VLAN Stacking Defaults” on page 36-2.](#)
- [“VLAN Stacking Overview” on page 36-3.](#)
- [“Interaction With Other Features” on page 36-7.](#)
- [“Configuring VLAN Stacking Services” on page 36-10](#)
- [“VLAN Stacking Application Example” on page 36-21..](#)
- [“Verifying the VLAN Stacking Configuration” on page 36-24](#)
- [“Verifying the VLAN Stacking Configuration” on page 36-24.](#)

VLAN Stacking Specifications

Platforms supported	OmniSwitch 6860, 6860E
IEEE Standards supported	IEEE 802.1Q, 2003 Edition, IEEE Standards for Local and metropolitan area networks—Virtual Bridged Local Area Networks P802.1ad/D6.0 (C/LM) Standard for Local and Metropolitan Area Networks - Virtual Bridged Local Area Networks - Amendment 4: Provider Bridges
Maximum number of services	4K
Maximum number of SVLANs	4K
Maximum number of SAPs	8K
Maximum number of SAP profiles	8K
Maximum number of customer VLANs (CVLANs) associated with a SAP	4K
Maximum number of service-to-SAP associations	1K

VLAN Stacking Defaults

Parameter Description	Command	Default Value/Comments
SVLAN administrative and Spanning Tree status.	ethernet-service svlan	Enabled
Vendor TPID and legacy BPDU support for STP on a VLAN Stacking network port.	ethernet-service nni	TPID = 0x8100 legacy STP BPDU = dropped.
Acceptable frame types on a VLAN Stacking user port.	ethernet-service sap cvlan	None.
Traffic engineering profile attributes for a VLAN Stacking Service Access Point (SAP).	ethernet-service sap-profile	ingress bandwidth = shared ingress bandwidth mbps = 0 CVLAN tag is preserved. SVLAN priority mapping = 0
Treatment of customer protocol control frames ingressing on a VLAN Stacking user port.	ethernet-service uni-profile	Processed Frames: 802.3ad, UDLD, OAM, LACPMarker Tunneled Frames: STP, MVRP, Discarded Frames: 802.1ab, VTP VLAN, Uplink Fast, PVST, PAGP, DTP, CDP

VLAN Stacking Overview

VLAN Stacking provides a mechanism for defining a transparent bridging configuration through a service provider network. The major components of VLAN Stacking that provide this type of functionality are described as follows:

- **Provider Edge (PE) Bridge**—An ethernet switch that resides on the edge of the service provider network. The PE Bridge interconnects customer network space with service provider network space. A switch is considered a PE bridge if it transports packets between a customer-facing port and a network port or between two customer-facing ports.
- **Transit Bridge**—An ethernet switch that resides inside the service provider network and provides a connection between multiple provider networks. It employs the same SVLAN on two or more network ports. This SVLAN does not terminate on the switch itself; traffic ingressing on a network port is switched to other network ports. It is also possible for the same switch to function as a both a PE Bridge and a Transit Bridge.
- **Tunnel (SVLAN)**—A tunnel, also referred to as an SVLAN, is a logical entity that connects customer networks by transparently bridging customer traffic through a service provider network. The tunnel is defined by an SVLAN tag that is appended to all customer traffic. This implementation provides an SVLAN that is defined by the type of traffic that it carries - an SVLAN that *carries customer traffic*.
- **Network-Network Interface (NNI)**—An NNI is a port that resides on either a PE Bridge or a Transit Bridge and connects to a service provider network. Traffic ingressing on a network port is considered SVLAN traffic and is switched to a customer-facing port or to another network port.
- **User Network Interface (UNI)**—A UNI is a port that resides on a PE bridge that connects to a customer network and carries customer traffic. The UNI may consist of a single port or an aggregate of ports and can accept tagged or untagged traffic.

The following illustration shows how VLAN Stacking uses the above components to tunnel customer traffic through a service provider network:

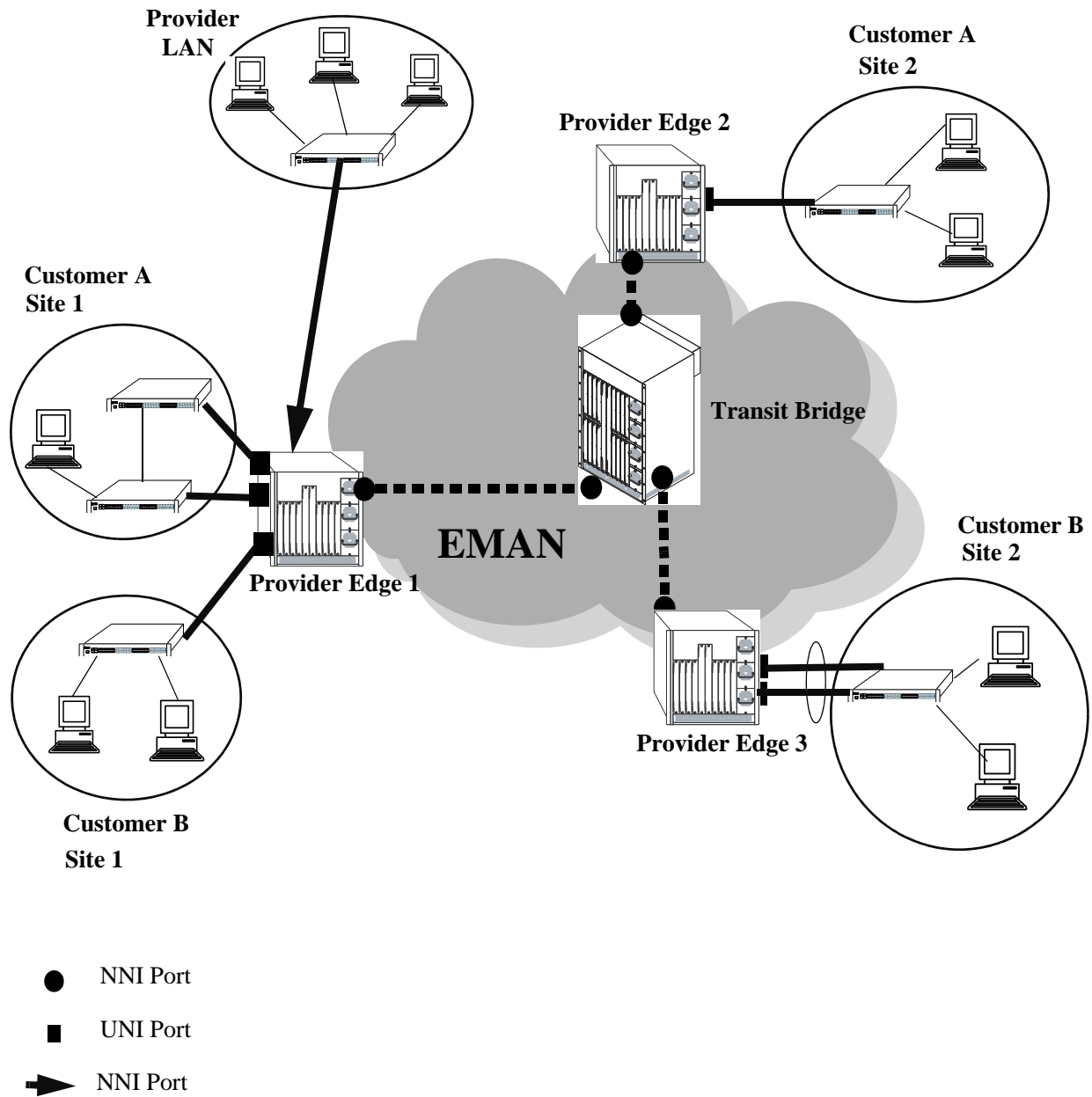

VLAN Stacking Elements

How VLAN Stacking Works

On the Provider Edge bridge (PE), a unique tunnel (SVLAN) ID is assigned to each customer. The tunnel ID corresponds to a VLAN ID, which is created on the switch when the tunnel is configured. For example, when tunnel 100 is created, VLAN Stacking software interacts with VLAN Manager software to configure a VLAN 100 on the switch. VLAN 100 is the provider bridge VLAN that will tunnel customer VLAN traffic associated with tunnel 100. So, there is a one to one correspondence between a tunnel and its provider bridge VLAN ID. In fact, tunnel and VLAN are interchangeable terms when referring to the provider bridge configuration.

VLAN Stacking refers to the tunnel encapsulation process of appending to customer packets an 802.1Q tag that contains the tunnel ID associated to that customer's provider bridge port and/or VLANs. The encapsulated traffic is then transmitted through the Ethernet metro area network (EMAN) cloud and received on another PE bridge that contains the same tunnel ID, where the packet is then stripped of the tunnel tag and forwarded to the traffic destination.

The following provides an example of how a packet ingressing on a VLAN Stacking UNI port that is tagged with the customer VLAN (CVLAN) ID transitions through the VLAN Stacking encapsulation process:

- 1 Packet with CVLAN tag ingressing on a user port.

MAC DA (6)	MAC SA (6)	CVLAN Tag (4)	ETYPE 0x0800	Payload
---------------	---------------	------------------	-----------------	---------

- 2 **Double Tagging** inserts the SVLAN tag in the packet. The packet is sent out the network port with double tags (SVLAN+CVLAN).

MAC DA (6)	MAC SA (6)	SVLAN Tag (4)	CVLAN Tag (4)	ETYPE 0x0800	Payload
---------------	---------------	------------------	------------------	-----------------	---------

- 3 **VLAN Translation** replaces the CVLAN Tag with SVLAN Tag. The packet is sent out the network port with a single tag (SVLAN).

MAC DA (6)	MAC SA (6)	SVLAN Tag (4)	ETYPE 0x0800	Payload
---------------	---------------	------------------	-----------------	---------

VLAN Stacking Services

The VLAN Stacking application uses an Ethernet service based approach for tunneling customer traffic through a provider network. This approach requires the configuration of the following components to define a tunneling service:

- **VLAN Stacking Service**—A service name that is associated with an SVLAN, NNI ports, and one or more VLAN Stacking service access points. The service identifies the customer traffic that the SVLAN will carry through the provider traffic.
- **Service Access Point (SAP)**—A SAP is associated with a VLAN Stacking service name and a SAP profile. The SAP binds UNI ports and customer traffic received on those ports to the service. The profile specifies traffic engineering attribute values that are applied to the customer traffic received on the SAP UNI ports.
- **Service Access Point (SAP) Profile**—A SAP profile is associated with a SAP ID. Profile attributes define values for ingress bandwidth sharing, rate limiting, CVLAN tag processing (translate or preserve), and priority mapping (inner to outer tag or fixed value).
- **UNI Port Profile**—This type of profile is associated with each UNI port and configures how Spanning Tree, and other control packets are processed on the UNI port.

See the [“Configuring VLAN Stacking Services” on page 36-10](#) for more information.

Interaction With Other Features

This section contains important information about VLAN Stacking interaction with other OmniSwitch features. Refer to the specific chapter for each feature to get more detailed information about how to configure and use the feature.

Link Aggregation

- Both static and dynamic link aggregation are supported with VLAN Stacking.
- Note that a link aggregate must consist of all UNI or all NNI ports. VLAN Stacking functionality is not supported on link aggregates that consist of a mixture of VLAN Stacking ports and conventional switch ports.

Quality of Service (QoS)

The QoS application has the following interactions with VLAN Stacking:

- By default, QoS allocates switch resources for VLAN Stacking Service attributes, even though such attributes are not configurable through the QoS CLI.
- The **ethernet-service sap-profile** command is used to create a VLAN Stacking service access point (SAP) profile. When the **bandwidth not-assigned** and **priority not-assigned** parameters are used with this command, QoS is prevented from allocating switch resources for the SAP profile.
- VLAN Stacking ports are trusted and use 802.1p classification.
- If there is a conflict between VLAN Stacking Service attributes and the QoS configuration, the VLAN Stacking attributes are given precedence over QoS policies.
- QoS applies the **inner source vlan** and **inner 802.1p** policy conditions to the CVLAN (inner) tag of VLAN Stacking packets.
- QoS applies the **source vlan** and **802.1p** policy conditions to the SVLAN (outer) tag of VLAN Stacking packets.

Spanning Tree

- Spanning Tree is automatically enabled for VLAN Stacking SVLANs. The Spanning Tree status for an SVLAN is configurable through VLAN Stacking commands. Note that the SVLAN Spanning Tree status applies only to the service provider network topology.
- BPDU frames are tunneled by default. See [“Configuring a UNI Profile” on page 36-19](#) for information about configuring VLAN Stacking to tunnel or discard Spanning Tree BPDU.
- See [“Configuring VLAN Stacking Network Ports” on page 36-13](#) for information about configuring VLAN Stacking interoperability with *legacy* Spanning Tree BPDU systems.
- A back door link configuration is not supported. This occurs when there is a link between two customer sites that are both connected to a VLAN Stacking provider edge switch.
- A dual home configuration is not supported. This type of configuration consists of a single customer site connected to two different VLAN Stacking switches or two switches at a customer site connect to two different VLAN Stacking switches.

Quick Steps for Configuring VLAN Stacking

The following steps provide a quick tutorial for configuring a VLAN Stacking service:

- 1 Create a VLAN Stacking VLAN (SVLAN) 1001 using the **ethernet-service svlan** command.

```
-> ethernet-service svlan 1001
```

- 2 Create a VLAN Stacking service and associate the service with SVLAN 1001 using the **ethernet-service service-name** command.

```
-> ethernet-service service-name CustomerA svlan 1001
```

- 3 Configure port 1/1/1 as a VLAN Stacking Network Network Interface (NNI) port and associate the port with SVLAN 1001 using the **ethernet-service svlan nni** command.

```
-> ethernet-service svlan 1001 nni port 1/1/1
```

- 4 Create a VLAN Stacking Service Access Point (SAP) and associate it to the “CustomerA” service using the **ethernet-service sap** command.

```
-> ethernet-service sap 10 service-name CustomerA
```

- 5 Configure port 1/1/49 as a VLAN Stacking User Network Interface (UNI) port and associate the port with SAP ID 10 using the **ethernet-service sap uni** command.

```
-> ethernet-service sap 10 uni port 1/1/49
```

- 6 Associate traffic from customer VLANs (CVLAN) 10 and 20 with SAP 10 using the **ethernet-service sap cvlan** command.

```
-> ethernet-service sap 10 cvlan 10
```

```
-> ethernet-service sap 10 cvlan 20
```

- 7 (Optional) Create a SAP profile that applies an ingress bandwidth of 10, translates the CVLAN tag, and maps the CVLAN priority to the SVLAN priority using the **ethernet-service sap-profile** command.

```
-> ethernet-service sap-profile sap-video1 ingress-bandwidth 10 cvlan translate  
priority map-inner-to-outer-p
```

- 8 (Optional) Associate the “sap-video1” profile with SAP 10 using the **ethernet-service sap sap-profile** command.

```
-> ethernet-service sap 10 sap-profile sap-video1
```

- 9 (Optional) Create a UNI port profile to block STP control frames received on UNI ports using the **ethernet-service uni-profile** command.

```
-> ethernet-service uni-profile uni_1 l2-protocol stp discard
```

- 10 (Optional) Associate the “uni_1” profile with port 1/1/49 using the **ethernet-service uni uni-profile** command.

```
-> ethernet-service uni port 1/1/49 uni-profile uni_1
```

Note. Verify the VLAN Stacking Ethernet service configuration using the **show ethernet-service** command:

```
-> show ethernet-service

Service Name : VideoOne
  SVLAN      : 300
  NNI(s)     : 2/1/1, 3/1/2
  SAP Id     : 20
    UNIs      : 1/1/1, 1/1/2
    CVLAN(s)  : 10, 20
    sap-profile : sap-video1
  SAP Id     : 30
    UNIs      : 1/1/3
    CVLAN(s)  : untagged, 40
    sap-profile : sap-video2

Service Name : CustomerABC
  SVLAN      : 255
  NNI(s)     : 1/1/22
  SAP Id     : 10
    UNIs      : 2/1/10, 2/1/11
    CVLAN(s)  : 500, 600
    sap-profile : default-sap-profile

-> show ethernet-service service-name CustomerABC

Service Name : CustomerABC
  SVLAN      : 255
  NNI(s)     : 1/1/22
  SAP Id     : 10
    UNIs      : 2/1/10, 2/1/11
    CVLAN(s)  : 500, 600
    sap-profile : default-sap-profile

-> show ethernet-service svlan 300

Service Name : VideoOne
  SVLAN      : 300
  NNI(s)     : 2/1/1, 3/1/2
  SAP Id     : 20
    UNIs      : 1/1/1, 1/1/2
    CVLAN(s)  : 10, 20
    sap-profile : sap-video1
  SAP Id     : 30
    UNIs      : 1/1/3
    CVLAN(s)  : 30, 40
    sap-profile : sap-video2
```

See the *OmniSwitch AOS Release 8 CLI Reference Guide* for information about the fields in this display.

Configuring VLAN Stacking Services

Configuring a VLAN Stacking Ethernet service requires several steps. These steps are outlined here and further described throughout this section. For a brief tutorial on configuring a VLAN Stacking service, see [“Quick Steps for Configuring VLAN Stacking” on page 36-8](#).

- 1 Create an SVLAN.** An SVLAN is associated to a VLAN Stacking service to carry customer or provider traffic. See [“Configuring SVLANs” on page 36-11](#).
- 2 Create a VLAN Stacking service.** A service name is associated with an SVLAN to identify the customer traffic that the SVLAN will carry through the provider network. See [“Configuring a VLAN Stacking Service” on page 36-12](#).
- 3 Configure Network Network Interface (NNI) ports.** An NNI port is associated with an SVLAN and carries the encapsulated SVLAN traffic through the provider network. See [“Configuring VLAN Stacking Network Ports” on page 36-13](#).
- 4 Configure a VLAN Stacking service access point (SAP).** A SAP binds UNI ports, the type of customer traffic, and traffic engineering parameter attributes to the VLAN Stacking service. Each SAP is associated to one service name, but a single service can have multiple SAPs to which it is associated. See [“Configuring a VLAN Stacking Service Access Point” on page 36-14](#).
- 5 Configure User Network Interface (UNI) ports.** One or more UNI ports are associated with a SAP to identify to the service which ports will receive customer traffic that the service will process for tunneling through the provider network. When a UNI port is associated with a SAP, the SAP parameter attributes are applied to traffic received on the UNI port. See [“Configuring VLAN Stacking User Ports” on page 36-16](#).
- 6 Associate CVLAN traffic with a SAP.** This step specifies the type of traffic customer traffic that is allowed on UNI ports and then tunneled through the SVLAN. The type of customer traffic is associated with a SAP and applies to all UNI ports associated with the same SAP. See [“Configuring the Type of Customer Traffic to Tunnel” on page 36-16](#).
- 7 Define SAP profile attributes.** A SAP profile contains traffic engineering attributes for specifying bandwidth sharing, rate limiting, CVLAN translation or double-tagging, and priority bit mapping. A default profile is automatically associated with a SAP at the time the SAP is created. As a result, it is only necessary to configure a SAP profile if the default attribute values are not sufficient. See [“Configuring a Service Access Point Profile” on page 36-18](#).
- 8 Define UNI profile attributes.** A default UNI profile is automatically assigned to a UNI port at the time a port is configured as a VLAN Stacking UNI. This profile determines how control frames received on the port are processed. It is only necessary to configure a UNI profile if the default attribute values are not sufficient. See [“Configuring a UNI Profile” on page 36-19](#).

The following table provides a summary of commands used in these procedures:

Commands	Used for ...
ethernet-service svlan	Creating SVLANs to tunnel customer traffic.
ethernet-service service-name	Creating a VLAN Stacking service and associating the service with an SVLAN.
ethernet-service svlan nni	Configuring a switch port as a VLAN Stacking NNI port and associating the NNI port with an SVLAN.
ethernet-service nni	Configuring a vendor TPID and legacy Spanning Tree support for an NNI port.
ethernet-service sap	Creating a VLAN Stacking SAP and associates the SAP with a VLAN Stacking service name.
ethernet-service sap uni	Configuring a switch port as a VLAN Stacking UNI port and associating the UNI port with a VLAN Stacking SAP.
ethernet-service sap cvlan	Specifying the type of customer traffic that is accepted on SAP UNI ports.
ethernet-service sap-profile	Configures traffic engineering attributes for customer traffic that is accepted on SAP UNI ports.
ethernet-service sap sap-profile	Associates a VLAN Stacking SAP with a profile.
ethernet-service uni-profile	Configures how protocol control frames are processed on VLAN Stacking UNI ports.
ethernet-service uni uni-profile	Associates a VLAN Stacking UNI port with a profile.

Configuring SVLANs

SVLANs carry customer traffic and are not configurable or modifiable using standard VLAN commands.

The **ethernet-service svlan** command is used to create an SVLAN. This command provides parameters to specify the type of SVLAN: **svlan** for customer traffic. For example, the following command creates a customer SVLAN:

```
-> ethernet-service svlan 300
```

Similar to standard VLANs, the administrative and Spanning Tree status for the SVLAN is enabled by default and the SVLAN ID is used as the default name. The **ethernet-service svlan** command also provides parameters for changing any of these status values and the name. These are the same parameters that are used to change these values for standard VLANs. For example, the following commands change the administrative and Spanning Tree status and name for SVLAN 300:

```
-> ethernet-service svlan 300 disable
-> ethernet-service svlan 300 stp disable
-> ethernet-service svlan 300 name "Customer A"
```

To delete an SVLAN from the switch configuration, use the **no** form of the **ethernet-service svlan** command. For example, to delete SVLAN 300 enter:

```
-> no ethernet-service svlan 300
```

Note that when an SVLAN is deleted, all port associations with the SVLAN are also removed.

Use the **show ethernet-service vlan** command to display a list of VLAN Stacking VLANs configured for the switch.

Configuring a VLAN Stacking Service

A VLAN Stacking service is identified by a name. The **ethernet-service service-name** command is used to create a service and assign the service to an SVLAN ID, depending on the type of traffic the service will process. The ID specified with this command identifies the SVLAN that will carry traffic for the service. Each service is associated with only one SVLAN, but an SVLAN may belong to multiple services.

To create a VLAN Stacking service, use the **ethernet-service service-name** command and specify a name and SVLAN ID. For example, the following command creates a service named “Video-Service” and associates the service with SVLAN 300:

```
-> ethernet-service service-name Video-Service svlan 300
```

The SVLAN ID specified with this command must already exist in the switch configuration; entering a standard VLAN ID is not allowed. See “[Configuring SVLANs](#)” on page 36-11 for more information.

Once the VLAN Stacking service is created, the name is used to configure and display all components associated with that service. The service name provides a single point of reference for a specific VLAN Stacking configuration. For example, the following **show ethernet-service** command display shows how the service name identifies a VLAN Stacking service and components related to that service:

```
-> show ethernet-service
```

```
Service Name : VideoOne
  SVLAN      : 300
  NNI(s)     : 2/1/1, 3/1/2
  SAP Id     : 20
    UNIs      : 1/1/1, 1/1/2
    CVLAN(s)  : 10, 20
    sap-profile : sap-video1
  SAP Id     : 30
    UNIs      : 1/1/3
    CVLAN(s)  : untagged, 40
    sap-profile : sap-video2

Service Name : CustomerABC
  SVLAN      : 255
  NNI(s)     : 1/1/22
  SAP Id     : 10
    UNIs      : 2/1/10, 2/1/11
    CVLAN(s)  : 500, 600
    sap-profile : default-sap-profile
```

```
-> show ethernet-service service-name CustomerABC
```

```
Service Name : CustomerABC
  SVLAN      : 255
  NNI(s)     : 1/1/22
  SAP Id     : 10
    UNIs      : 2/1/10, 2/1/11
    CVLAN(s)  : 500, 600
    sap-profile : default-sap-profile
```



```
-> show ethernet-service svlan 300
```

```
Service Name : VideoOne
SVLAN       : 300
NNI(s)      : 2/1/1, 3/1/2
SAP Id      : 20
  UNIs       : 1/1/1, 1/1/2
  CVLAN(s)   : 10, 20
  sap-profile : sap-video1
SAP Id      : 30
  UNIs       : 1/1/3
  CVLAN(s)   : 30, 40
  sap-profile : sap-video2
```

To delete a service from the switch configuration, use the **no** form of the **ethernet-service service-name** command. For example, the following command deletes the “Video-Service” service:

```
-> no ethernet-service service-name Video-Service
```

Note that when a VLAN Stacking service is deleted, the SVLAN ID association with the service is automatically deleted. However, if one or more VLAN Stacking service access point (SAP) are associated with the service, remove the SAPs first before attempting to delete the service.

Configuring VLAN Stacking Network Ports

The **ethernet-service nni** command is used to configure a switch port or link aggregate of ports as a VLAN Stacking Network Network Interface (NNI). For example, the following command configures port 2/1/1 as an NNI port:

```
-> ethernet-service nni port 2/1/1
```

When a port is converted to a NNI port, the default VLAN for the port is changed to a VLAN that is reserved for the VLAN Stacking application. At this point, the port is no longer configurable using standard VLAN port commands.

The **ethernet-service nni** command is also used to optionally specify the following parameter values that are applied to traffic processed by the NNI port:

- **tpid**—Configures the vendor TPID value for the SVLAN tag. This value is set to the default and is applied to traffic egressing on the NNI port and is compared to the SVLAN tag of packets ingressing on the NNI port. If the configured NNI TPID value and the ingress packet value match, then the packet is considered an SVLAN tagged packet. If these values do not match, then the packet is classified as a non-SVLAN tagged packet.
- **stp legacy-bpdu**—Specifies whether or not legacy Spanning Tree BPDU are tunneled on the NNI port.

The following command example configures the vendor TPID for NNI port 2/1/1 to 0x88a8 and enables support for Spanning Tree legacy BPDU:

```
-> ethernet-service nni port 2/1/1 tpid 88a8 stp legacy-bpdu enable
```

Consider the following when configuring NNI port parameter values:

- A mismatch of TPID values on NNI ports that are connected together is not supported; VLAN Stacking will not work between switches using different NNI TPID values.

- Enable legacy BPDU support only on VLAN Stacking network ports that are connected to legacy BPDU switches. Enabling legacy BPDU between AOS switches may cause flooding or an unstable network.
- If legacy BPDU is enabled on a network port while at same time BPDU flooding is enabled on user ports, make sure that tagged customer BPDUs are not interpreted by intermediate switches in the provider network.
- If the peer switch connected to the VLAN Stacking network port supports the Provider MAC address (i.e., STP, 802.1ad/D6.0 MAC), then enabling legacy BPDU support is not required on the network port. Refer to the following table to determine the type of STP MAC used:

STP	
Customer MAC	{0x01, 0x80, 0xc2, 0x00, 0x00, 0x00}
Provider MAC address (802.1ad/D6.0)	{0x01, 0x80, 0xc2, 0x00, 0x00, 0x08}
Provider MAC address (Legacy MAC)	{0x01, 0x80, 0xc2, 0x00, 0x00, 0x00}
Provider MAC address	{0x01, 0x80, 0xc2, 0x00, 0x00, 0x0D}

- STP legacy BPDU are supported only when the flat Spanning Tree mode is active on the switch.
- NNI ports can be 802.1q tagged with normal VLANs. The TPID of the packets tagged with the normal VLAN is 0x8100 (regardless of the TPID of the NNI port). This allows the NNI port to carry both 802.1q tagged traffic and SVLAN tagged traffic.

Configuring a NNI Association with a SVLAN

The **ethernet-service vlan nni** command is used to associate the NNI with an SVLAN. For example, the following command associates NNI 2/1/1 with SVLAN 300:

```
-> ethernet-service vlan 300 nni port 2/1/1
```

When a port is associated with an SVLAN using this command, the port is automatically defined as an NNI to carry traffic for the specified SVLAN.

To delete an NNI port association with an SVLAN, use the **no** form of the **ethernet-service vlan nni** command. For example, the following command deletes the NNI 2/1/1 and SVLAN 300 association:

```
-> no ethernet-service vlan 300 nni port 2/1/1
```

Use the **show ethernet-service nni** command to display the NNI port configuration for the switch.

Configuring a VLAN Stacking Service Access Point

The **ethernet-service sap** command is used to configure a VLAN Stacking service access point (SAP). An SAP is assigned an ID number at the time it is configured. This ID number is then associated with the following VLAN Stacking components:

- **User Network Interface (UNI) ports.** See [“Configuring VLAN Stacking User Ports”](#) on page 36-16.
- **Customer VLANs (CVLANs).** See [“Configuring the Type of Customer Traffic to Tunnel”](#) on page 36-16.

- **SAP profile.** Each SAP is associated with a single profile. This profile contains attributes that are used to define traffic engineering parameters applied to traffic ingressing on UNI ports that are associated with the SAP. See [“Configuring a Service Access Point Profile” on page 36-18](#).

The above components are all configured separately using different VLAN Stacking commands. The **ethernet-service sap** command is for creating a SAP ID and associating the ID with a VLAN Stacking service. For example, the following command creates SAP 20 and associates it with Video-Service:

```
-> ethernet-service sap 20 service-name Video-Service
```

To delete a VLAN Stacking SAP from the switch configuration, use the **no** form of the **ethernet-service sap** command. For example, the following command deletes SAP 20:

```
-> no ethernet-service sap 20
```

Note that when the SAP is deleted, all UNI port, CVLAN, and profile associations are automatically dropped. It is not necessary to remove these items before deleting the SAP.

A VLAN Stacking SAP basically identifies the location where customer traffic enters the provider network edge, the type of customer traffic to service, parameters to apply to the traffic, and the service that will process the traffic for tunneling through the provider network.

Consider the following when configuring a VLAN Stacking SAP:

- A SAP is assigned to only one service, but a service can have multiple SAPs. So, a single service can process and tunnel traffic for multiple UNI ports and customers.
- Associating multiple UNI ports to one SAP is allowed.
- A default SAP profile is associated with the SAP at the time the SAP is created. This profile contains the following default attribute values:

Ingress bandwidth sharing	shared
Ingress bandwidth maximum	0
Egress bandwidth maximum	0
CLAN tag	preserve (double-tag)
Priority mapping	fixed 0

The above default attribute values are applied to customer traffic associated with the SAP. Only one profile is assigned to each SAP; however, it is possible to use the same profile for multiple SAPs.

- To use different profile attribute values, create a new profile and associate it with the SAP. See [“Configuring a Service Access Point Profile” on page 36-18](#). Each time a profile is assigned to a SAP, the existing profile is overwritten with the new one.

Use the **show ethernet-service sap** command to display the SAPs configured for the switch. Use the **show ethernet-service** command to display a list of VLAN Stacking services and the SAPs associated with each service.

Configuring VLAN Stacking User Ports

The **ethernet-service sap uni** command is used to configure a switch port or a link aggregate as a VLAN Stacking User Network Interface (UNI) and associate the UNI with a VLAN Stacking service access point (SAP). For example, the following command configures port 1/1/1 as an UNI port and associates 1/1 with SAP 20:

```
-> ethernet-service sap 20 uni port 1/1/1
```

A UNI port is a customer-facing port on which traffic enters the VLAN Stacking service. When the port is associated with a service access point, the port is automatically defined as a UNI port and the default VLAN for the port is changed to a VLAN that is reserved for the VLAN Stacking application.

To delete a UNI port association with a VLAN Stacking SAP, use the **no** form of the **ethernet-service sap uni** command. For example, the following command deletes the association between UNI 1/1/1 and SAP 20:

```
-> no ethernet-service sap 20 uni port 1/1/1
```

Note that when the last SAP association for the port is deleted, the port automatically reverts back to a conventional switch port and is no longer VLAN Stacking capable.

Consider the following when configuring VLAN Stacking UNI ports:

- All customer traffic received on the UNI port is dropped until customer VLANs (CVLAN) are associated with the port. See [“Configuring the Type of Customer Traffic to Tunnel” on page 36-16](#).
- A default UNI profile is assigned to the port at the time the port is configured. This profile defines how control frames received on the UNI ports are processed. While Spanning Tree frames are automatically tunneled, all other protocol control frames are dropped.
- To use different profile attribute values, create a new profile and associate it with the UNI port. See [“Configuring a UNI Profile” on page 36-19](#). Each time a profile is assigned to a UNI, the existing profile is overwritten with the new one.
- Only fixed ports can be converted to UNI ports.

Use the **show ethernet-service uni** command to display a list of UNI ports and the profile association for each port.

Configuring the Type of Customer Traffic to Tunnel

The **ethernet-service sap cvlan** command is used to associate customer traffic with a VLAN Stacking service access point (SAP). This identifies the type of customer traffic received on the SAP UNI ports that the service will process and tunnel through the SVLAN configured for the service. For example, the following command specifies that traffic tagged with customer VLAN (CVLAN) 500 is allowed on UNI ports associated with SAP 20:

```
-> ethernet-service sap 20 cvlan 500
```

In this example, customer frames tagged with VLAN ID 500 that are received on SAP 20 UNI ports are processed by the service to which SAP 20 is associated. This includes applying profile attributes associated with SAP 20 to the qualifying customer frames. If no other customer traffic is specified for SAP 20, all other frames received on SAP 20 UNI ports are dropped.

In addition to specifying one or more CVLANs, it is also possible to specify the following parameters when using the **ethernet-service sap cvlan** command:

- **all**—Specifies that all untagged and tagged frames are accepted on the UNI ports. This mapping denotes that all customer frames that do not map to any other SAP, will be mapped into this service.
- **untagged**—Specifies that only untagged frames are accepted on the UNI ports. This mapping denotes that only untagged frames will be mapped into this service.

For example, the following command specifies that all untagged frames are accepted on UNI ports associated with SAP 20:

```
-> ethernet-service sap 20 cvlan untagged
```

Use the **no** form of the **ethernet-service sap cvlan** command to delete an association between customer traffic and a VLAN Stacking SAP. For example, the following command deletes the association between CVLAN 500 and SAP 20:

```
-> no ethernet-service sap 20 cvlan 500
```

Note that when the last customer traffic association is deleted from a SAP, the SAP itself is not automatically deleted. No traffic is accepted or processed by a SAP in this state, but the SAP ID is still known to the switch.

Consider the following when configuring the type of customer traffic to tunnel:

- If no customer traffic is associated with a VLAN Stacking SAP, then the SAP does not process any traffic for the service.
- Only one **all** or **untagged** designation is allowed for any given SAP; specifying both for the same SAP is not allowed.
- Only one **untagged** designation is allowed per UNI port, even if the UNI port is associated with multiple SAPs.
- Only one **all** designation is allowed per UNI port, even if the UNI port is associated with multiple SAPs.

Use the **show ethernet-service** command to display the type of customer traffic associated with each SAP configured for the switch

Configuring a Service Access Point Profile

The **ethernet-service sap-profile** command is used to create a VLAN Stacking service access point (SAP) profile. The following command parameters define the traffic engineering attributes that are applied to customer traffic that is accepted on UNI ports associated with the SAP profile:

Profile Attribute	Command Parameters	Description
Ingress bandwidth sharing	shared not shared	Whether or not ingress bandwidth is shared across UNI ports and CVLANs.
Ingress rate limiting	ingress-bandwidth	The rate at which customer frames ingress on UNI ports.
Egress rate limiting	egress-bandwidth	The rate at which customer frames egress on UNI ports.
Bandwidth assignment	bandwidth not-assigned	Allows QoS policy rules to override profile attribute values for bandwidth. By default, the profile bandwidth values take precedence and are allocated additional QoS system resources.
Double-tag or translate	cvlan preserve translate	Determines if a customer frame is tagged with the SVLAN ID (double-tag) or the CVLAN ID is changed to the SVLAN ID (translate) when the frame is encapsulated for tunneling. Double-tag is used by default.
Priority mapping	map-inner-to-outer-p map-dscp-to-outer-p fixed	Determines if the CVLAN (inner tag) 802.1p or DSCP value is mapped to the SVLAN (outer tag) 802.1p value or if a fixed priority value is used for the SVLAN 802.1p value. Priority mapping is set to a fixed rate of zero by default.
Priority assignment	priority not-assigned	Allows QoS policy rules to override profile attribute values for priority. By default, profile priority values take precedence and are allocated additional QoS system resources.

A default profile, named “default-sap-profile”, is automatically assigned to the SAP at the time the SAP is created (see “[Configuring a VLAN Stacking Service Access Point](#)” on page 36-14). It is only necessary to create a new profile to specify different attribute values if the default profile values (see above) are not sufficient.

The following command provides an example of creating a new SAP profile to specify a different method for mapping the SVLAN priority value:

```
-> ethernet-service sap-profile map_pbit priority map-inner-to-outer-p
```

In this example the **map_pbit** profile specifies priority mapping of the CVLAN inner tag 802.1p value to the SVLAN outer tag value. The other attributes in this profile are set to their default values.

To delete a SAP profile, use the **no** form of the **ethernet-service sap-profile** command. For example, the following command deletes the **map_pbit** profile:

```
-> no ethernet-service sap-profile map_pbit
```

Consider the following when configuring a SAP profile:

- When a profile is created, **bandwidth not-assigned** and **priority not-assigned** parameters are *not* specified. This means that even if no bandwidth value is specified or the priority is set to fixed, QoS still allocates switch resources to enforce bandwidth and priority settings for the profile. In addition, QoS policy rules cannot override the profile bandwidth or priority settings.
- Use the **bandwidth not-assigned** and **priority not-assigned** parameters to prevent the profile from triggering QoS allocation of switch resources. When a profile is created using these parameters, QoS policy rules/ACLs are then available to define more custom bandwidth and priority settings for profile traffic. For example, mapping several inner DSCP/ToS values to the same outer 802.1p value.
- Egress bandwidth can be configured only for SVLANs.
- A CVLAN-UNI combination associated with a SAP having egress bandwidth configuration is unique and it cannot be configured on any other SAP with egress bandwidth configuration.

Use the **show ethernet-service sap-profile** command to view a list of profiles that are already configured for the switch. This command also displays the attribute values for each profile.

Associating a Profile with a Service Access Point

After a profile is created, it is then necessary to associate the profile with a VLAN Stacking SAP. When this is done, the current profile associated with a SAP is replaced with the new profile.

The **ethernet-service sap sap-profile** command is used to associate a new profile with a VLAN Stacking SAP. For example, the following command associates the map_pbit profile to SAP 20:

```
-> ethernet-service sap 20 sap-profile map_pbit
```

To change the profile associated with the SAP back to the default profile, specify “default-sap-profile” for the profile name. For example:

```
-> ethernet-service sap 20 sap-profile default-sap-profile
```

Use the **show ethernet-service sap** command to display the SAP configuration, which includes the profile association for each SAP.

Configuring a UNI Profile

The **ethernet-service uni-profile** command is used to create a VLAN Stacking UNI port profile. The UNI profile determines how control frames ingressing on UNI ports are processed. For example, the following command creates a UNI profile to specify that VLAN Stacking must discard MVRP frames:

```
-> ethernet-service uni-profile uni_1 l2-protocol mvrp discard
```

A default UNI profile, named “default-uni-profile”, already exists in the switch configuration and is automatically associated with a UNI port. Use the **show ethernet-service uni-profile** command to display the default profile settings. For example:

```
-> show ethernet-service uni-profile default-uni-profile
  Profile Name      Stp      802.1x    802.3ad    802.1ab    MVRP      AMAP
-----+-----+-----+-----+-----+-----+-----
default-uni-profile tunnel  tunnel  tunnel    tunnel    tunnel    tunnel
```

To delete a UNI profile, use the **no** form of the **ethernet-service uni-profile** command. For example, the following command deletes the **uni_1** profile:

```
-> no ethernet-service uni-profile uni_1
```

The **show ethernet-service uni-profile** command is also used to view a list of all profiles that are already configured for the switch.

Associating UNI Profiles with UNI Ports

After a UNI profile is created, it is then necessary to associate the profile with a UNI port or a UNI link aggregate. When this is done, the current profile associated with the port is replaced with the new profile.

The **ethernet-service uni uni-profile** command is used to associate a new profile with a UNI port. For example, the following command associates the **uni_1** profile to UNI port 1/1/1:

```
-> ethernet-service uni port 1/1/1 uni-profile uni_1
```

To change the profile associated with the UNI port back to the default profile, specify “default-uni-profile” for the profile name. For example:

```
-> ethernet-service uni port 1/1/1 uni-profile default-uni-profile
```

Use the **show ethernet-service uni** command to display the profile associations for each UNI port.

VLAN Stacking Application Example

The VLAN Stacking feature provides the ability to transparently connect multiple customer sites over a single shared service provider network. This section demonstrates this ability by providing a sample VLAN Stacking configuration that tunnels customer VLANs (CVLAN) inside a service provider VLAN (SVLAN) so that customer traffic is transparently bridged through a Metropolitan Area Network (MAN).

The illustration below shows the sample VLAN Stacking configuration described in this section. In this configuration, the provider edge bridges will encapsulate Customer A traffic (all CVLANs) into SVLAN 100 and Customer B traffic (CVLAN 10 only) into SVLAN 200. In addition, the CVLAN 10 inner tag priority bit value is mapped to the SVLAN out tag priority value. The customer traffic is then transparently bridged across the MAN network and sent out to the destined customer site.

Double-tagging is the encapsulation method used in this application example. This method consists of appending the SVLAN tag to customer packets ingressing on provider edge UNI ports so that the traffic is bridged through the provider network SVLAN. The SVLAN tag is then stripped off of customer packets egressing on provider edge UNI ports before the packets are delivered to their destination customer site.

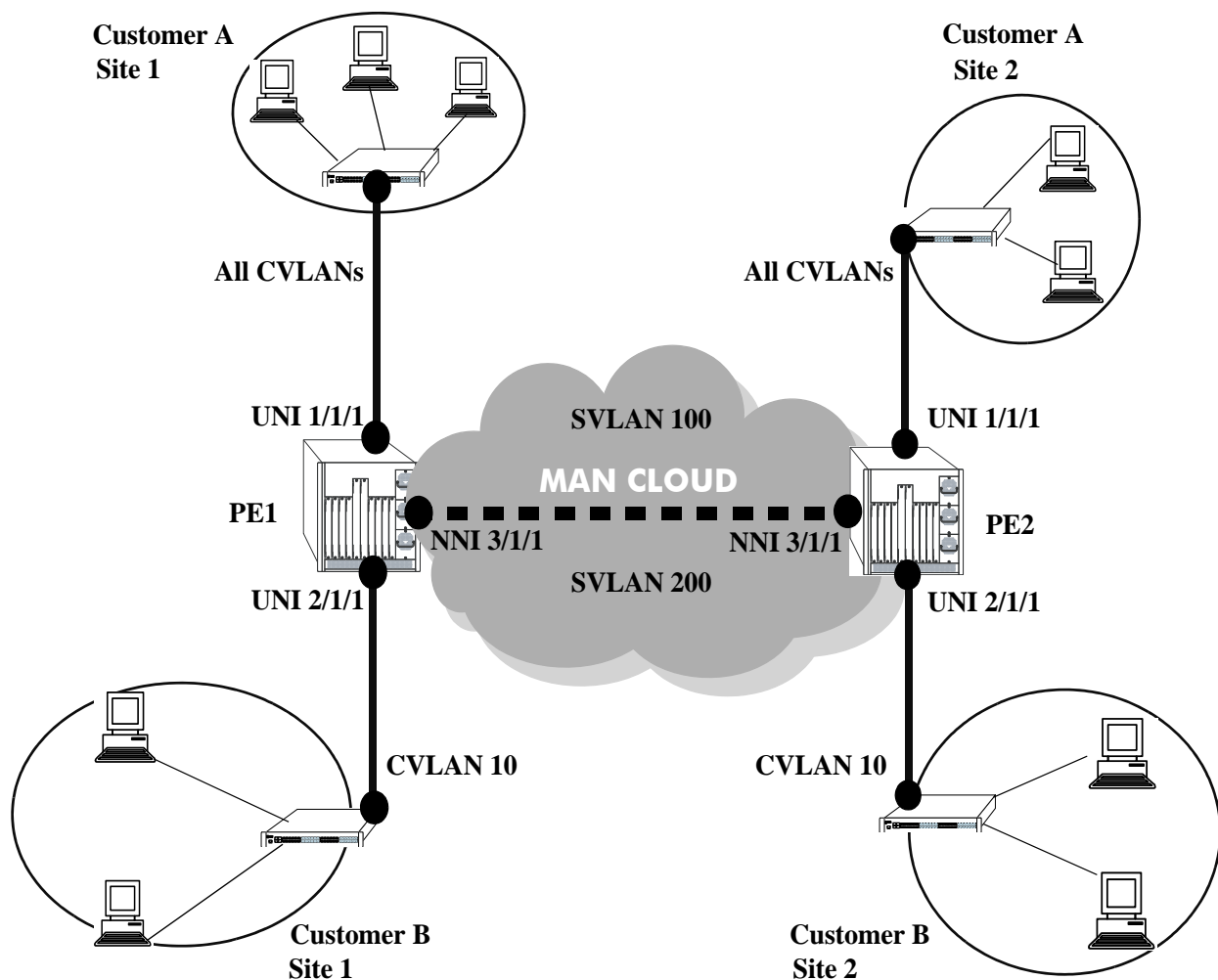

VLAN Stacking Application

VLAN Stacking Configuration Example

This section provides a tutorial for configuring the sample application, as illustrated on [page 36-21](#), using VLAN Stacking Ethernet services. This tutorial assumes that both provider edge switches (PE1 and PE2) are operating in the VLAN Stacking service mode.

1 Configure SVLAN 100 and SVLAN 200 on PE1 *and* PE2 switches using the **ethernet-service svlan** command.

```
-> ethernet-service svlan 100
-> ethernet-service svlan 200
```

2 Configure two VLAN Stacking services on PE1 *and* PE2 using the **ethernet-service service-name** command. Configure one service with the name “CustomerA” and the other service with the name “Customer B”. Assign “CustomerA” service to SVLAN 100 and “CustomerB” service to SVLAN 200.

```
-> ethernet-service service-name CustomerA svlan 100
-> ethernet-service service-name CustomerB svlan 200
```

3 Configure port 3/1/1 on PE1 *and* PE2 as VLAN Stacking NNI ports using the **ethernet-service svlan nni** command. Associate each port with both SVLAN 100 and SVLAN 200.

```
-> ethernet-service svlan 100 nni port 3/1/1
-> ethernet-service svlan 200 nni port 3/1/1
```

4 Configure a VLAN Stacking SAP with ID 20 on PE1 *and* PE2 using the **ethernet-service sap**. Associate the SAP with the “CustomerA” service.

```
-> ethernet-service sap 20 service-name CustomerA
```

5 Configure a VLAN Stacking SAP with ID 30 on PE1 *and* PE2 using the **ethernet-service sap** command. Associate the SAP with the “CustomerB” service.

```
-> ethernet-service sap 30 service-name CustomerB
```

6 Configure port 1/1/1 on PE1 *and* PE2 as a VLAN Stacking UNI port and associate 1/1/1 with SAP 20 using the **ethernet-service sap uni** command.

```
-> ethernet-service sap 20 uni port 1/1/1
```

7 Configure port 2/1/1 on PE1 *and* PE2 as a VLAN Stacking UNI port and associate 2/1/1 with SAP 30 using the **ethernet-service sap uni** command.

```
-> ethernet-service sap 30 uni port 2/1/1
```

8 Configure SAP 20 on PE1 *and* PE2 to accept all customer traffic using the **ethernet-service sap cvlan** command.

```
-> ethernet-service sap 20 cvlan all
```

9 Configure SAP 30 on PE1 *and* PE2 to accept only customer traffic that is tagged with CVLAN 10 using the **ethernet-service sap cvlan** command.

```
-> ethernet-service sap 30 cvlan 10
```

10 Create a SAP profile on PE1 *and* PE2 that will map the inner CVLAN tag 802.1p value to the outer SVLAN tag using the **ethernet-service sap-profile** command.

```
-> ethernet-service sap-profile map_pbit priority map-inner-to-outer-p
```

11 Associate the “map_pbit” profile to SAP 30 using the `ethernet-service sap sap-profile` command. This profile only applies to Customer B traffic, so it is not necessary to associate the profile with SAP 20.

```
-> ethernet-service sap 30 sap-profile map_pbit
```

12 Verify the VLAN Stacking service configuration using the `show ethernet-service` command.

```
-> show ethernet-service
Service Name : CustomerA
  SVLAN      : 100
  NNI(s)     : 3/1/1
  SAP Id     : 20
  UNIs       : 1/1/1
  CVLAN(s)   : all
  sap-profile : default-sap-profile

Service Name : CustomerB
  SVLAN      : 200
  NNI(s)     : 3/1/1
  SAP Id     : 10
  UNIs       : 2/1/1
  CVLAN(s)   : 10
  sap-profile : map_pbit

Service Name : CustomerABC
  SVLAN      : 255
  NNI(s)     : 1/22
  SAP Id     : 10
  UNIs       : 2/1/10, 2/1/11
  CVLAN(s)   : 500, 600
  sap-profile : default-sap-profile
```

```
-> show ethernet-service service-name CustomerABC
Service Name : CustomerABC
  SVLAN      : 255
  NNI(s)     : 1/1/22
  SAP Id     : 10
  UNIs       : 2/1/10, 2/1/11
  CVLAN(s)   : 500, 600
  sap-profile : default-sap-profile
```

The following is an example of what the sample configuration commands look like entered sequentially on the command line of the provider edge switches:

```
-> ethernet-service svlan 100
-> ethernet-service service-name CustomerA svlan 100
-> ethernet-service svlan 100 nni port 3/1/1
-> ethernet-service sap 20 service-name CustomerA
-> ethernet-service sap 20 uni 1/1/1
-> ethernet-service sap 20 cvlan all

-> ethernet-service svlan 200
-> ethernet-service service-name CustomerB svlan 200
-> ethernet-service svlan 200 nni port 3/1/1
-> ethernet-service sap 30 service-name CustomerB
-> ethernet-service sap 30 uni 2/1/1
-> ethernet-service sap 30 cvlan 10
-> ethernet-service sap-profile map_pbit priority map-inner-to-outer-p
-> ethernet-service sap 30 sap-profile map_pbit
```

Verifying the VLAN Stacking Configuration

You can use CLI **show** commands to display the current configuration and statistics of service-based VLAN Stacking on a switch. These commands include the following:

show ethernet-service vlan	Displays the SVLAN configuration for the switch.
show ethernet-service	Displays the VLAN Stacking service configuration for the switch.
show ethernet-service sap	Displays the VLAN Stacking service access point (SAP) configuration for the switch.
show ethernet-service nni	Displays configuration information for NNI port parameters.
show ethernet-service uni	Displays profile associations for UNI ports.
show ethernet-service uni-profile	Displays UNI profile attribute values.
show ethernet-service sap-profile	Displays SAP profile attribute values.

For more information about the resulting displays from these commands, see the *OmniSwitch AOS Release 8 CLI Reference Guide*. An example of the output for the **show ethernet-service** command is also given in “Quick Steps for Configuring VLAN Stacking” on page 36-8.

37 Using Switch Logging

Switch logging is an event logging utility that is useful in maintaining and servicing the switch. Switch logging uses a formatted string mechanism to either record or discard event data from switch applications. The log records are copied to the output devices configured for the switch. Log records can be sent to a text file and written into the flash file system. The log records can also be scrolled to the console of the switch or to a remote IP address.

Switch logging information can be customized and configured through Command Line Interface (CLI) commands, WebView, and SNMP. Log information can be helpful in resolving configuration or authentication issues, as well as general switch errors.

This chapter describes the switch logging feature, how to configure it and display switch logging information through the Command Line Interface (CLI). CLI commands are used in the configuration examples. For more details about the syntax of commands, see the *OmniSwitch AOS Release 8 CLI Reference Guide*.

In This Chapter

The following procedures are described:

- [“Enabling Switch Logging” on page 37-5](#)
- [“Setting the Switch Logging Severity Level” on page 37-5](#)
- [“Specifying the Switch Logging Output Device” on page 37-8](#)
- [“Displaying Switch Logging Records” on page 37-11](#)

Note. Switch logging commands are not intended for use with low-level hardware and software debugging. It is strongly recommended that you contact an Alcatel-Lucent Customer Service representative for assistance with debugging functions.

Switch Logging Specifications

Platforms Supported	OmniSwitch 6860, 6860E
RFCs Supported	RFC 5424–Syslog Protocol
Functionality Supported	High-level event logging mechanism that forwards requests from applications to enabled logging devices.
Number of Syslog Servers Supported	12
Logging Devices	Flash Memory/Console/IP Address
Application ID Levels Supported	IDLE (255), DIAG (0), IPC-DIAG (1), QDRIVER (2), QDISPATCHER (3), IPC-LINK (4), NI-SUPERVISION (5), INTERFACE (6), 802.1Q (7), VLAN (8), GM (9), BRIDGE (10), STP (11), LINKAGG (12), QOS (13), RSVP (14), IP (15), IPMS (17), AMAP (18), GMAP (19), SLB(25), AAA (20), IPC-MON (21), IP-HELPER (22), PMM (23), MODULE (24), EIPC (26), CHASSIS (64), PORT-MGR (65), CONFIG (66), CLI (67), SNMP (68), WEB (69), MIPGW (70), SESSION (71), TRAP (72), POLICY (73), DRC (74), SYSTEM (75), HEALTH (76), NAN-DRIVER (78), RMON (79), TELENET (80), PSM (81), FTP (82), SNMI (83), DISTRIB (84), EPILOGUE (85), LDAP (86), NOSNMP (87), SSL (88), DBGGW (89), LANPOWER (108)
Severity Levels/Types Supported	2 (Alarm - highest severity), 3 (Error), 4 (Alert), 5 (Warning) 6 (Info - default), 7 (Debug 1), 8 (Debug 2), 9 (Debug 3 - lowest severity)

Switch Logging Defaults

The following table shows switch logging default values:

Parameter Description	CLI Command	Default Value/Comments
Enabling/Disabling switch logging	swlog	Enabled
Switch logging severity level	swlog appid	Default severity level is info. The numeric equivalent for info is 6
Enabling/Disabling switch logging Output	swlog output	Flash Memory and Console
Switch logging file size	swlog output flash-file-size	1250K bytes

Quick Steps for Configuring Switch Logging

- 1 Enable switch logging by using the following command:

```
-> swlog
```

- 2 Specify the ID of the application to be logged along with the logging severity level.

```
-> swlog appid bridge level warning
```

Here, the application ID specifies bridging and the severity is set to the “warning” level.

- 3 Specify the output device to which the switch logging information must be sent.

```
-> swlog output console
```

```
-> show swlog
Operational Status           : Running,
File Size per file           : 100K bytes,
Log Device                    : console flash,
Syslog FacilityID            : local0(16),
Hash Table entries age limit : 60 seconds,
Switch Log Preamble          : Enabled,
Switch Log Debug              : Disabled,
Switch Log Duplicate Detection : Enabled,
Console Display Level        : debug3,
```

Switch Logging Overview

Switch logging uses a formatted string mechanism to process log requests from switch applications. When a log request is received, switch logging compares the severity level included with the request to the severity level stored for the application ID. If there is a match, a log message is generated using the format specified by the log request and placed in the switch log queue. Switch logging then returns control back to the calling application.

You can specify the path to where the log file is printed in the flash file system of the switch. You can also send the log file to other output devices, such as the console or remote IP address. In this case, the log records generated are copied to all configured output devices.

Switch logging information can be displayed and configured through CLI commands, WebView, and SNMP. The information generated by switch logging can be helpful in resolving configuration or authentication issues, as well as general errors.

Note. Although switch logging provides complementary functionality to switch debugging facilities, the switch logging commands are not intended for use with low-level hardware and software debugging functions.

Switch Logging Commands Overview

This section describes the switch logging CLI commands, for enabling or disabling switch logging, displaying the current status of the switch logging feature, and displaying stored log information.

Enabling Switch Logging

The **swlog** command initializes and enables switch logging, while **no swlog** disables it.

To enable switch logging, enter the **swlog** command:

```
-> swlog
```

To disable switch logging, enter the **no swlog** command:

```
-> no swlog
```

No confirmation message appears on the screen for either command.

Setting the Switch Logging Severity Level

The switch logging feature can log all switch error-type events for a particular switch application. You can also assign severity levels to the switch applications that cause some of the events to be filtered out of your display. The **swlog appid** command is used to assign the severity levels to the applications.

The syntax for the **swlog appid** command requires that you identify a switch application and assign it a severity level. The severity level controls the kinds of error-type events that are recorded by the switch logging function. If an application experiences an event equal to or greater than the severity level assigned to the application, the event is recorded and forwarded to the configured output devices. You can specify the application either by the application ID CLI keyword or by its numeric equivalent.

The application ID information is shown in the following table. The severity level information is shown in the table beginning on [page 37-7](#).

CLI Keyword	Numeric Equivalent	Application ID
IDLE	255	APPID_IDLE
DIAG	0	APPID_DIAGNOSTICS
IPC-DIAG	1	APPID_IPC_DIAGNOSTICS
QDRIVER	2	APPID_QDRIVER
QDISPATCHER	3	APPID_QDISPATCHER
IPC-LINK	4	APPID_IPC_LINK
NI-SUPERVISION	5	APPID_NI_SUP_AND_PROBER
INTERFACE	6	APPID_ESM_DRIVER
802.1Q	7	APPID_802.1Q
VLAN	8	APPID_VLAN_MGR
GM	9	APPID_GROUPMOBILITY (RESERVED)
BRIDGE	10	APPID_SRCLEANING

CLI Keyword	Numeric Equivalent	Application ID
STP	11	APPID_SPANNINGTREE
LINKAGG	12	APPID_LINKAGGREGATION
QOS	13	APPID_QOS
RSVP	14	APPID_RSVP
IP	15	APPID_IP
IPMS	17	APPID_IPMS
AMAP	18	APPID_XMAP
GMAP	19	APPID_GMAP
AAA	20	APPID_AAA
IPC-MON	21	APPID_IPC_MON
IP-HELPER	22	APPID_BOOTP_RELAY
PMM	23	APPID_MIRRORING_MONITORING
MODULE	24	APPID_L3HRE
SLB	25	APPID_SLB
EIPC	26	APPID_EIPC
CHASSIS	64	APPID_CHASSISUPER
PORT-MGR	65	APPID_PORT_MANAGER
CONFIG	66	APPID_CONFIGMANAGER
CLI	67	APPID_CLI
SNMP	68	APPID_SNMP_AGENT
WEB	69	APPID_WEBMGT
MIPGW	70	APPID_MIPGW
SESSION	71	APPID_SESSION_MANAGER
TRAP	72	APPID_TRAP_MANAGER
POLICY	73	APPID_POLICY_MANAGER
DRC	74	APPID_DRC
SYSTEM	75	APPID_SYSTEM_SERVICES
HEALTH	76	APPID_HEALTHMON
NAN-DRIVER	78	APPID_NAN_DRIVER
RMON	79	APPID_RMON
TELNET	80	APPID_TELNET
PSM	81	APPID_PSM
FTP	82	APPID_FTP
SMNI	83	APPID_SMNI
DISTRIB	84	APPID_DISTRIB

CLI Keyword	Numeric Equivalent	Application ID
EPILOGUE	85	APPID_EPILOGUE
LDAP	86	APPID_LDAP
NOSNMP	87	APPID_NOSNMP
SSL	88	APPID_SSL
DBGGW	89	APPID_DBGGW
LANPOWER	108	APPID_LANPOWER

The **level** keyword assigns the error-type severity level to the specified application IDs. Values range from 2 (highest severity) to 9 (lowest severity). The values are defined in the following table:

Severity Level	Type	Description
2 (<i>highest severity</i>)	Alarm	A serious, non-recoverable error has occurred and the system must be rebooted.
3	Error	System functionality is reduced.
4	Alert	A violation has occurred.
5	Warning	An unexpected, non-critical event has occurred.
6 (<i>default</i>)	Info	Any other non-debug message.
7	Debug 1	A normal event debug message.
8	Debug 2	A debug-specific message.
9 (<i>lowest severity</i>)	Debug 3	A maximum verbosity debug message.

Specifying the Severity Level

To specify the switch logging severity level, use the **swlog appid** command. The application ID can be expressed by using either the ID number or the application ID CLI keyword as listed in the table beginning on [page 37-5](#). The severity level can be expressed by using either the severity level number or the severity level type as shown in the table above. The following syntax assigns the “warning” severity level (or 5) to the “system” application, (ID number 75) by using the severity level and application names.

```
-> swlog appid system level warning
```

The following command makes the same assignment by using the severity level and application numbers.

```
-> swlog appid 75 level 3
```

No confirmation message appears on the screen for either command.

Removing the Severity Level

To remove the switch logging severity level, enter the **no swlog appid** command, including the application ID and severity level values. The following is a typical example:

```
-> no swlog appid 75 level 5
```

Or, alternatively, as:

```
-> no swlog appid system level warning
```

No confirmation message appears on the screen.

Specifying the Switch Logging Output Device

The **swlog output** command allows you to send the switch logging information to your console, to the switch's flash memory, or to a specified IP or IPv6 address(es).

Enabling/Disabling Switch Logging Output to the Console

To enable the switch logging output to the console, enter the following command:

```
-> swlog output console
```

To disable the switch logging output to the console, enter the following command:

```
-> no swlog output console
```

No confirmation message appears on the console screen for either command.

Enabling/Disabling Switch Logging Output to Flash Memory

To enable the switch logging output to flash memory, enter the following:

```
-> swlog output flash
```

To disable the switch logging output to flash memory, enter the following command:

```
-> no swlog output flash
```

No confirmation message appears on the screen for either command.

Specifying an IP Address for Switch Logging Output

To specify a particular IP address destination (for example, a server) for switch logging output, enter the **swlog output** command, specifying the target IP address to which output is sent. For example, if the target IP address is 168.23.9.100, you would enter:

```
-> swlog output socket ipaddr 168.23.9.100
```

No confirmation message appears on the screen.

Disabling an IP Address from Receiving Switch Logging Output

To disable all configured output IP addresses from receiving switch logging output, enter the following command:

```
-> no swlog output socket
```

No confirmation message appears on the screen.

To disable a specific configured output IP address from receiving switch logging output, use the same command as above but specify an IPv4 or IPv6 address. For example:

```
-> no swlog output socket 174.16.5.1
```

Configuring the Switch Logging File Size

To configure the size of the switch logging file, use the **swlog output flash-file-size** command. To use this command, enter **swlog output flash file size** followed by the number of bytes. (The maximum size the file can be is dependent on the amount of free memory available in flash.)

For example, to set the switch logging file to 500000 bytes enter:

```
-> swlog output flash file-size 500000
```

Clearing the Switch Logging Files

You can clear the data stored in the switch logging files by executing the following command:

```
-> swlog clear
```

This command causes the switch to clear all the switch logging information and begin recording again. As a result, the switch displays a shorter file when you execute the **show log swlog** command. You want to use **swlog clear** when the switch logging display is too long due to some of the data being old or out of date.

No confirmation message appears on the screen.

Displaying Switch Logging Records

The **show log swlog** command can produce a display showing *all* the switch logging information or you can display information according to session, timestamp, application ID, or severity level. For details, refer to the *OmniSwitch AOS Release 8 CLI Reference Guide*. The following sample screen output shows a display of all the switch logging information.

Note. Switch logging frequently records a very large volume of data. It can take several minutes for all the switch logging information to scroll to the console screen.

```
-> show log swlog
Displaying file contents for 'swlog2.log'
FILEID: fileName[swlog2.log], endPtr[32]
        configSize[64000], currentSize[64000], mode[2]
Displaying file contents for 'swlog1.log'
FILEID: fileName[swlog1.log], endPtr[395]
        configSize[64000], currentSize[64000], mode[1]
```

Time Stamp	Application	Level	Log Message
MON NOV 11 12:42:11 2005	SYSTEM	info	Switch Logging files cleared by command
MON NOV 11 13:07:26 2005	WEB	info	The HTTP session login successful!
MON NOV 11 13:18:24 2005	WEB	info	The HTTP session login successful!
MON NOV 11 13:24:03 2005	TELNET	info	New telnet connection, Address, 128.251.30.88
MON NOV 11 13:24:03 2005	TELNET	info	Session 4, Created
MON NOV 11 13:59:04 2005	WEB	info	The HTTP session user logout successful!

38 Configuring Ethernet OAM

The rise in the number of Ethernet service instances has resulted in service providers requiring a powerful and robust set of management tools to maintain Ethernet service networks. Service provider networks are large and intricate, often consisting of different operators that work together to provide the customers with end-to-end services. The challenge for the service providers is to provide a highly available, convergent network to the customer base. Ethernet OAM (Operations, Administration, and Maintenance) provides the detection, resiliency, and monitoring capability for end-to-end service guarantee in an Ethernet network.

In This Chapter

This chapter describes the Ethernet OAM feature, how to configure it and display Ethernet OAM information through the Command Line Interface (CLI). For more details about the syntax of commands, see the *OmniSwitch AOS Release 8 CLI Reference Guide*.

The following information and procedures are included in this chapter:

- [“Ethernet OAM Overview” on page 38-3.](#)
- [“Elements of Service OAM” on page 38-3.](#)
- [“Fault Management” on page 38-5.](#)
- [“Performance Monitoring” on page 38-5.](#)
- [“Interoperability with ITU-T Y.1731” on page 38-7.](#)
- [“Configuring Ethernet OAM” on page 38-9.](#)
- [“Verifying the Ethernet OAM Configuration” on page 38-14.](#)

Ethernet OAM Specifications

The following table lists Ethernet OAM specifications.

Standards Supported	IEEE 802.1ag Version 8.1– <i>Connectivity Fault Management</i> IEEE 802.1D– <i>Media Access Control (MAC) Bridges</i> IEEE 802.1Q– <i>Virtual Bridged Local Area Networks</i> ITU-T Y.1731– <i>OAM Functions and Mechanisms for Ethernet-Based Networks</i>
Platforms Supported	OmniSwitch 6860, 6860E
Maximum Maintenance Domains (MD) per Bridge	8
Maximum Maintenance Associations (MA) per Bridge	128
Maximum Maintenance End Points (MEP) per Bridge	256

Ethernet OAM Defaults

The following table shows Ethernet OAM default values.

Parameter Description	Command	Default Value/Comments
MHF value assigned to a MD	ethoam domain mhf	none
ID-permission value for MD entry	ethoam domain id-permission	none
MHF value assigned to a MA	ethoam association mhf	defer
Continuity Check Message interval for the MA	ethoam association ccm-interval	10 seconds
Default domain level	ethoam default-domain level	0
Default domain MHF value	ethoam default-domain mhf	none
Default domain ID permission	ethoam default-domain id-permission	none
The administrative status of the MEP	ethoam endpoint admin-state	disable
The priority value for CCMs and LTMs transmitted by the MEP	ethoam endpoint priority	7
The lowest priority fault alarm for the lowest defect priority for a MEP	ethoam endpoint lowest-defect-priority	mac-rem-err-xcon
Number of Loopback messages	ethoam loopback	1
Fault notification generation reset time	ethoam fault-reset-time	1000 centi-seconds

Ethernet OAM Overview

Ethernet OAM focuses on two main areas that service providers require the most and are rapidly evolving in the standards bodies:

- Service OAM (IEEE 802.1ag and ITU-T Y.1731)—for monitoring and troubleshooting end-to-end Ethernet service instances.
- Link OAM (IEEE 802.3ah EFM Link OAM)—for monitoring and troubleshooting individual Ethernet links.

These two protocols are both unique and complimentary. For example, Service OAM may isolate a fault down to a specific service, but to determine exactly where the fault occurred within the network infrastructure might also require the use of Link OAM.

Ethernet Service OAM

Ethernet Service OAM allows service providers to manage customer services end-to-end on a per-service-instance basis. A customer service instance, or Ethernet Virtual Connection (EVC), is the service that is sold to a customer and is designated by a VLAN tag on the User-to-Network Interface (UNI).

Elements of Service OAM

- Maintenance End Points (MEPs) and Maintenance Intermediate Points (MIPs)
 - MEPs initiate OAM commands. MEPs prevent leakage between domains.
 - MIPs passively receive and respond to OAM frames.
- Virtual MEP: creates an UP MEP on a virtual port.
- Maintenance Association (MA) is a logical connection between two or more MEPs.
- Point-to-point MA: logical sub-MA component only between two MEPs MA.
- Maintenance Domain: One or more MAs under the same administrative control.
- Maintenance Domain Levels: There are eight levels defined in 802.1ag:
 - levels [5, 6, 7] are for customers
 - levels [3, 4] are for service provider
 - levels [0, 1, 2] are for operatorsMultiple levels are supported for flexibility.
- Mechanisms: continuity check (CC), loopback, link trace
- Remote Fault Propagation (RFP): Propagates connectivity fault events into the interface attached to a MEP.

CFM Maintenance Domain

CFM uses a hierarchical Maintenance Domain (MD) infrastructure to manage and administer Ethernet networks.

- Each domain is made up of Maintenance Endpoints (MEPs) and Maintenance Intermediate Points (MIPs).

- The MEPs are configured on edge ports within the domain for each EVC. The MIPs are configured on relevant ports within the domain itself (interior ports).
- The network administrator selects the relevant points within the network to determine where maintenance points are needed. The maintenance point configuration defines the MD.
- MDs are assigned an unique level number (between 0 and 7) to help identify and differentiate the MD within the domain hierarchy. For example, different organizations, such as operators (levels 0, 1, 2), service providers (levels 3, 4), and customers (levels 5, 6, 7), are involved in a Metro Ethernet Service.
- Each organization can have its own Maintenance Domain, designated by the assigned level number to specify the scope of management needed for that domain.

The following illustration shows an example of the CFM Maintenance Domain hierarchy:

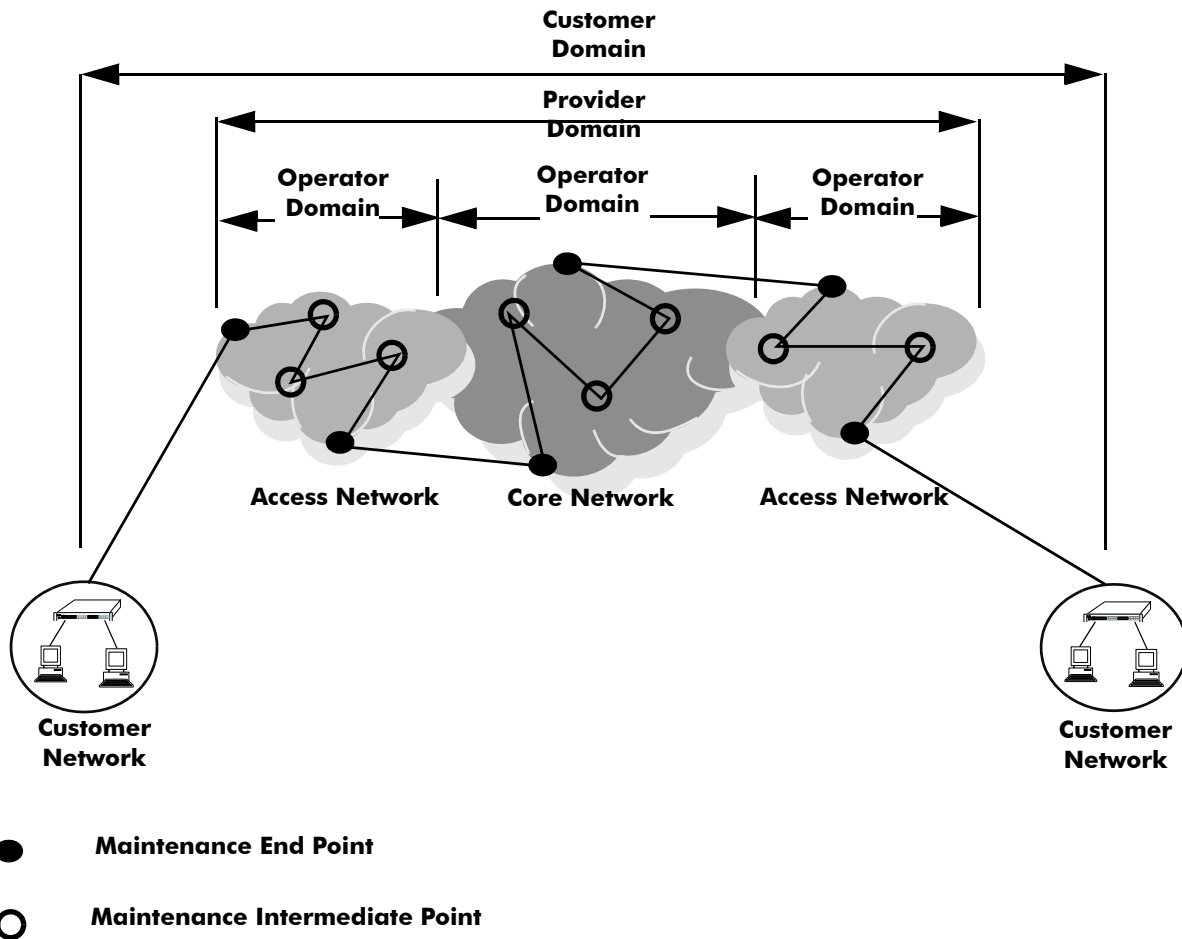

Fault Management

Service OAM Connectivity Fault Management consists of three types of messages that are used to help network administrators detect, verify, and isolate when a problem occurs in the network:

- **Continuity Check Messages (CCM)**—These are multicast messages exchanged periodically by MEPs to detect loss of service connectivity between MEPs. These messages are also used by MEPs and MIPs to discover other MEPs within a domain.
- **Linktrace Messages (LTM)**—These messages are transmitted by a MEP to trace the path to a destination maintenance point. The receiving maintenance point responds to LTMs with a linktrace reply (LTR). This mechanism is similar to the UDP Trace Route function. The transmission of linktrace messages is requested by an administrator.
- **Loopback Messages (LBM)**—These messages are transmitted by a MEP to a specified MIP or MEP to determine whether or not the maintenance point is reachable. The receiving maintenance point responds to LBMs with a loopback reply (LBR). This mechanism is not used to discover a path to the destination; it is similar to the Ping function. The transmission of loopback messages is requested by an administrator.

Remote Fault Propagation

Remote Fault propagation (RFP) propagates connectivity fault events into the interface that is attached to a MEP. Once the fault is detected for a MEP, the MEP's interface is shutdown. The feature is configurable on per MEP basis and is supported only for UP MEPs. It detects only loss of connectivity and remote MAC defect.

MIP CCM Database Support

Per section 19.4 of the IEEE 802.1ag 5.2 draft standard, an MHF may optionally maintain a MIP CCM database as it is not required for conformance to this standard. A MIP CCM database, if present, maintains the information received from the MEPs in the MD and can be used by the Linktrace Protocol.

This implementation of Ethernet OAM does not support the optional MIP CCM database. As per section 19.4.4 of the IEEE 802.1ag 5.2 draft standard, LTM is forwarded on the basis of the source learning filtering database. Because the MIP CCM database is not supported in this release, MIPs will not forward LTM on blocked egress ports.

Performance Monitoring

The ITU-T Y.1731 Recommendation addresses the need to monitor performance to help enforce customer service level agreements (SLAs). Frame delay (latency) and frame delay variation (jitter) are important performance objectives, especially for those applications (such as voice) that cannot function with a high level of latency or jitter.

This implementation of Service OAM supports Ethernet frame delay measurement (ETH-DM) and is compliant with Y.1731. The ETH-DM feature allows for the configuration of on-demand OAM to measure frame delay and frame delay variation between endpoints.

Frame delay measurement is performed between peer MEPs (measurements to MIPs are not done) within the same MA. Although the OmniSwitch implementation of ETH-DM is compliant with ITU-T Y.1731, delay measurement can be performed for both ITU-T Y.1731 and IEEE 802.1ag MEPs.

Any MEP can initiate or reply to an ETH-DM request, depending on the type of delay measurement requested. There are two types of delay measurements supported: one-way and two-way.

One-way ETH-DM

- A MEP sends one-way delay measurement (1DM) frames to a peer MEP. The sending MEP inserts the transmission time into the 1DM frame at the time the frame is sent.
- When a MEP receives a 1DM frame, the MEP calculates the one-way delay as the difference between the time at which the frame was received and the transmission time indicated by the frame timestamp (receive time minus transmission time).
- One-way delay measurement statistics are gathered and stored on the receiving MEP (the MEP that receives a 1DM request).
- One-way ETH-DM requires clock synchronization between the sending and receiving MEPs. Using NTP for clock synchronization is recommended.

Two-way ETH-DM

- A MEP sends delay measurement message (DMM) frames to a peer MEP to request a two-way ETH-DM. The sending MEP inserts the transmission time into the DMM frame at the time the frame is sent.
- When a MEP receives a DMM frame, the MEP responds to the DMM with a delay message reply (DMR) frame that contains the following timestamps:
 - Timestamp copied from the DMM frame.
 - Timestamp indicating when the DMM frame was received.
 - Timestamp indicating the time at which the receiving MEP transmitted the DMR frame back to the sending MEP.
- When a MEP receives a DMR frame, the MEP compares all the DMR timestamps with the time at which the MEP received the DMR frame to calculate the two-way delay.
- The two-way delay is the difference between the time the originating MEP sent a DMM request and the time at which the originating MEP received a DMR frame minus the time taken by the responding MEP to process the DMM request.
- Two-way delay measurement statistics are gathered and stored on the originating MEP (the MEP that initiates a DMM request).
- This method *does not* require clock synchronization between the transmitting and receiving MEPs.
- Two-way ETH-DM is an on-demand OAM performance measurement.

Frame Delay Variation

The delay variation (jitter) for both one-way and two-way ETH-DM is determined by calculating the difference between the current delay measurement value and the previous delay measurement value. If a previous delay value is not available, which is the case when a DM request is first made, then jitter is not calculated.

Interoperability with ITU-T Y.1731

This implementation of Ethernet Service OAM supports both IEEE 802.1ag and ITU-T Y.1731 for connectivity fault management (plus performance monitoring provided by ITU-T Y.1731). Although both standards are supported, the OmniSwitch implementation uses the 802.1ag terminology and hierarchy for Ethernet CFM configuration.

The following table provides a mapping of 802.1ag terms to the equivalent ITU-T Y.1731 terms:

IEEE 802.1ag v8.1	ITU-T Y.1731
Maintenance Domain (MD)	Maintenance Entity (ME)
Maintenance Association (MA)	Maintenance Entity Group (MEG)
Maintenance Endpoint (MEP)	MEG Endpoint (MEP)
Maintenance Intermediate Point (MIP)	MEG Intermediate Point (MIP)
Maintenance Domain Level	MEG Level

Support for both the IEEE and ITU-T Ethernet CFM standards allows interoperability between OmniSwitch 802.1ag and Y.1731 CFM with the following minor configuration requirements:

- The OmniSwitch MD format must be configured as “none”.
- ITU-T Y.1731 uses the “icc-based” format for a MEG, so the OmniSwitch MA format must also be configured to use the “icc-based” format.
- When the OmniSwitch MA is configured with the “icc-based” format, the MA name is automatically padded with zeros if the name specified is less than 13 characters.

The OmniSwitch CLI commands to configure an MD and MA include the “none” and “icc-based” format options. See [“Configuring Ethernet OAM” on page 38-9](#) for more information.

Quick Steps for Configuring Ethernet OAM

The following steps provide a quick tutorial on how to configure Ethernet OAM. Each step describes a specific operation and provides the CLI command syntax for performing that operation.

- 1 Create an Ethernet domain using the **ethoam domain** command. For example:

```
-> ethoam domain esd.alcatel-lucent.com format dnsName level 1
```

- 2 Create an Ethernet OAM Maintenance Association using the **ethoam association** command. For example:

```
-> ethoam association alcatel-sales format string domain esd.alcatel-lucent.com  
vlan 10
```

- 3 Create an Ethernet OAM Maintenance End Point using the **ethoam endpoint admin-state** command. For example:

```
-> ethoam endpoint 100 domain esd.alcatel-lucent.com association alcatel-sales  
direction up port 1/1/10
```

- 4 Administratively enable the Ethernet OAM Maintenance End Point using the **ethoam endpoint admin-state** command. For example:

```
-> ethoam endpoint 100 domain esd.alcatel-lucent.com association alcatel-sales  
admin-state enable
```

- 5 Enable Continuity Check Messages for the Ethernet OAM Maintenance End Point using the **ethoam endpoint rfp** command. For example:

```
-> ethoam endpoint 100 domain esd.alcatel-lucent.com association alcatel-sales  
ccm enable
```

- 6 Configure the Message Handling Function (MHF) value of an Ethernet OAM Maintenance Domain using the **ethoam domain mhf** command. For example:

```
-> ethoam domain esd.alcatel-lucent.com mhf explicit
```

- 7 Configure the endpoint list for the Ethernet OAM Maintenance Association using the **ethoam association endpoint-list** command. For example:

```
-> ethoam association alcatel-sales domain esd.alcatel-lucent.com endpoint-list  
100
```

- 8 Enable the maintenance entity to initiate transmitting loopback messages to obtain loopback replies using the **ethoam loopback** command. For example:

```
-> ethoam loopback target-endpoint 15 source-endpoint 100 domain esd.alcatel-  
lucent.com association alcatel-sales
```

Configuring Ethernet OAM

This section describes how to use Alcatel-Lucent's Command Line Interface (CLI) commands to configure Ethernet Service OAM on a switch. Consider the following guidelines when configuring Service OAM maintenance entities:

- Ethernet OAM is not supported on mobile, mirrored, or aggregate ports (the physical port members of an aggregate).
- Ethernet OAM is also not supported on dynamically learned VLANs.
- Implementing Ethernet OAM is supported on any full-duplex point-to-point or emulated point-to-point Ethernet link. It need not be implemented system wide.
- Management systems are important for configuring Ethernet OAM across the network. They also help to automate network monitoring and troubleshooting. Ethernet OAM can be configured in two phases: network configuration phase and service activation phase.
- The network configuration phase enables Connectivity Fault Management (CFM) on the switches. This is also the phase where Maintenance Intermediate Points (MIP) and Maintenance End Points (MEP) are identified and set up.
- Any port on a switch is referred to as a Maintenance Point (MP). An MP can be either a MEP or MIP. A MEP resides at the edge of a Maintenance Domain (MD), while a MIP is located within a MD.
- In the Service Activation phase, a new end point is created on a VLAN as a MEP. This enables the configuration of continuity-check and cross-check functionality.

Configuring a Maintenance Domain

To create a Maintenance Domain (MD), use the **ethoam domain** command, by entering **ethoam domain**, followed by the domain name, the keyword **format**, the domain name format type, the keyword **level**, and the level of the domain. For example:

```
-> ethoam domain esd.alcatel-lucent.com format dnsName level 5
```

Here, the MD **esd.alcatel.com** is created.

Note that the level must be 0-2 at operator level, 3-5 at provider level, and 6-7 at customer level when creating the level of domain.

To remove an MD, use the **no** form of this command. For example:

```
-> no ethoam domain esd.alcatel-lucent.com
```

Note that with this implementation of Ethernet OAM, it is only possible to delete an MD when there is no Maintenance Association, End Point, or Intermediate Point associated with the MD.

Modifying a Maintenance Domain

To modify the MHF value of an MD, use the **ethoam domain mhf** command, as shown:

```
-> ethoam domain esd.alcatel-lucent.com mhf explicit
```

To modify the default Ethernet OAM Maintenance Domain, use the **ethoam default-domain level** command, as shown:

```
-> ethoam default-domain vlan 100 level 4 mhf none
```

Note. The **no** form of this command restores the default Ethernet OAM Maintenance Domain value.

Configuring a Maintenance Association

To create an Ethernet OAM Maintenance Association (MA), use the **ethoam association** command. For example, to create the MA **alcatel-sales** in the **esd.alcatel.com** domain, enter:

```
-> ethoam association alcatel-sales format string domain esd.alcatel-lucent.com  
primary-vlan 10
```

To remove an MA, use the **no** form of this command. For example:

```
-> no ethoam association alcatel-sales domain esd.alcatel-lucent.com
```

Note that with this implementation of Ethernet OAM, it is only possible to delete an MA when there is no Maintenance End Point (MEP) or Maintenance Intermediate Point (MIP) associated with the MA.

Configuring Maintenance Association Attributes

The MIP Half Function (MHF), Continuity Check Message (CCM) interval, and MEP list are configurable attributes of a Maintenance Association.

By default, the MHF value is set to defer. To modify this value for an MA, use the **ethoam association mhf** command. For example:

```
-> ethoam association alcatel-sales domain esd.alcatel-lucent.com mhf default
```

By default, the CCM interval is set to 10 seconds. To modify this value for an MA, use the **ethoam association ccm-interval** command:

```
-> ethoam association alcatel-sales domain esd.alcatel-lucent.com ccm-interval  
intervallm
```

To modify the MEP list of an MA, use the **ethoam association endpoint-list** command, as shown:

```
-> ethoam association alcatel-sales domain esd.alcatel-lucent.com endpoint-list  
100-200
```

To remove the MEP list from an Ethernet OAM Maintenance Association, enter:

```
-> no ethoam association alcatel-sales domain esd.alcatel-lucent.com endpoint-  
list 100-200
```

Configuring a Maintenance End Point

To create an Ethernet OAM Maintenance End Point (MEP), use the **ethoam endpoint** command. For example, to create UP MEP 100 in domain “esd.alcatel-lucent.com” of the “alcatel-sales” Maintenance Association on port 1/1/2 of VLAN 400, enter:

```
-> ethoam end-point 100 domain esd.alcatel-lucent.com association alcatel-sales
direction up port 1/1/2 primary-vlan 400
```

To remove a MEP, use the **no** form of this command. For example:

```
-> no ethoam end-point 100 domain esd.alcatel-lucent.com association alcatel-
sales
```

To configure the administrative state of a MEP, use the **ethoam endpoint admin-state** command. For example:

```
-> ethoam end-point 100 domain esd.alcatel-lucent.com association alcatel-sales
admin-state enable
```

Configuring a Virtual Maintenance End Point

Virtual UP MEP is an UP MEP that is created on a 'virtual' port. This port is neither a physical port nor a logical port. This port is not connected to any switch interface. The virtual MEP will not transmit port and interface status TLVs.

The use of Virtual MEP allows to create a MEP on a virtual port thus saving the use of physical port.

To configure a virtual MEP, use the **ethoam endpoint** command. For example, to create UP MEP 100 in domain “esd.alcatel-lucent.com” of the “alcatel-sales” Maintenance Association on a virtual port of VLAN 400, enter:

```
-> ethoam end-point 100 domain esd.alcatel-lucent.com association alcatel-sales
direction up port virtual primary-vlan 400
```

Note the following when configuring the virtual MEP:

- A virtual MEP shall only be configured as an UP-MEP.
- Virtual MEP can be configured in any valid level.
- The virtual MEP is configured on a virtual port and not attached to any switch interface.
- Only one virtual MEP can be configured per switch.
- The behavior of virtual MEP will be the same as that of the MEPs created on physical ports.
- The Remote Fault Propagation feature is not supported for virtual UP MEP.

Configuring MEP Attributes

To configure the MEP to generate Continuity Check Messages (CCM), use the **ethoam endpoint rfp** command. For example:

```
-> ethoam end-point 100 domain esd.alcatel-lucent.com association alcatel-sales
ccm enable
```

To configure the priority values for Continuity Check Messages and Linktrace Messages transmitted by a MEP, use the **ethoam endpoint priority** command. For example:

```
-> ethoam end-point 100 domain esd.alcatel-lucent.com association alcatel-sales
priority 6
```

To configure the lowest priority fault alarm for the lowest defect priority for a MEP, use the **ethoam endpoint lowest-defect-priority** command. For example:

```
-> ethoam end-point 100 domain esd.alcatel-lucent.com association alcatel-sales
lowest-defect-priority all-defect
```

Configuring Loopback

To initiate transmitting Loopback messages (LBMs) and obtaining Loopback replies (LBRs), use the **ethoam loopback** command. For example:

```
-> ethoam loopback target-endpoint 10 source-endpoint 20 domain MD association
MA number 3
Reply from 00:0E:B1:6B:43:89: bytes=64 seq=0 time=100ms
Reply form 00:0E:B1:6B:43:89: bytes=64 seq=0 time=112ms
Request timed out.
----00:E0:B1:6B:43:89 ETH-LB Statistics----
3 packets transmitted, 2 packets received, 33% packet loss
round-trip (ms) min/avg/max = 100/106/112
```

Configuring Linktrace

To initiate transmitting Linktrace messages (LTMs) and detecting Linktrace replies (LTR), use the **ethoam linktrace** command. For example:

```
-> ethoam linktrace 10:aa:ac:12:12:ad end-point 4 domain esd.alcatel-lucent.com
association alcatel_sales flag fdbonly hop-count 32
```

Configuring the Fault Alarm Time

The Fault Alarm time is the period of time during which one or more defects must be detected before the Fault Alarm is issued. By default, this timer is set to 250 centiseconds. To change the Fault Alarm time, use the **ethoam fault-alarm-time** command. For example:

```
-> ethoam fault-alarm-time 500 end-point 100 domain esd.alcatel-lucent.com
association alcatel_sales
```

Configuring the Fault Reset Time

The Fault Reset time is the time interval in which Fault Alarm is re-enabled to process the faults. By default, this timer value is set to 1000 centiseconds. To change the Fault Reset time, use the **ethoam fault-reset-time** command. For example:

```
-> ethoam fault-reset-time 250 end-point 100 domain esd.alcatel-lucent.com
association alcatel_sales
```

Configuring Ethernet Frame Delay Measurement

Ethernet frame delay measurement (ETH-DM) is an on-demand OAM function used to measure frame delay (latency) and delay variation (jitter) between MEPs. There are two types of ETH-DM supported: one-way and two-way.

One-Way ETH-DM

The **ethoam one-way-delay** command is used to configure a one-way ETH-DM (1DM) to monitor performance between two MEPs. For example, the following command is used to initiate the transmission of 1DM frames to a target MEP:

```
-> ethoam one-way-delay target-endpoint 10 source-endpoint 12 domain MD1
association MA1 vlan-priority 4
```

This command initiates the sending of 1DM frames from MEP 12 to MEP 10, which does not reply to frames received from MEP 12. The latency and jitter statistics are gathered and stored on the receiving MEP, which is MEP 10 in this example.

An option to specify a target MAC address, instead of a MEP ID, is also supported. For example:

```
-> ethoam one-way-delay target-macaddress 00:e0:b1:6a:52:4c source-endpoint 12
domain MD association MA vlan-priority 4
```

One-way delay measurement statistics are gathered and stored on the receiving MEP (the MEP that receives a 1DM request).

Note. One-way ETH-DM requires clock synchronization between the sending and receiving MEPs. Using NTP for clock synchronization is recommended.

Two-Way ETH-DM

The **ethoam two-way-delay** command is used to configure a two-way ETH-DM to monitor roundtrip performance between two MEPs. For example, the following command is used to initiate the transmission of delay measurement message (DMM) frames to a target MEP:

```
-> ethoam two-way-delay target-endpoint 10 source-endpoint 12 domain MD
association MA vlan-priority 4
Reply from 00:0E:B1:6B:43:89 delay=2584us jitter=282us
```

This command initiates the sending of DMM frames from MEP 12 to MEP 10. However, with two-way delay measurement, the receiving MEP replies with delay message response (DMR) frames to the sending MEP. In this example, MEP 10 sends DMR frames back to MEP 12.

An option to specify a target MAC address, instead of a MEP ID, is also supported. For example:

```
-> ethoam two-way-delay target-macaddress 00:e0:b1:6a:52:4c source-endpoint 12
domain MD association MA vlan-priority 4
Reply form 00:E0:B1:6A:52:4C: delay=2584us jitter=282us
```

Note the following when configuring two-way ETH-DM:

- Two-way delay measurement statistics are gathered and stored on the originating MEP (the MEP that initiates a DMM request).
- This method *does not* require clock synchronization between the transmitting and receiving MEPs.
- Two-way ETH-DM is an on-demand OAM performance measurement.

Verifying the Ethernet OAM Configuration

To display information about Ethernet OAM on the switch, use the show commands listed below:

show ethoam	Displays the information of all the Management Domains configured on the switch.
show ethoam domain	Displays the information of a specific Management Domain configured on the switch.
show ethoam domain association	Displays the information of a specific MA in a Management Domain configured on the switch.
show ethoam domain association end-point	Displays the information of a specific MEP in a Management Domain configured on the switch.
show ethoam remote-endpoint domain	Displays the information of all remote MEPs learned as a part of the CCM message exchange.
show ethoam default-domain configuration	Displays all the default MD information for all the VLANs or a specific VLAN.
show ethoam default-domain configuration	Displays the values of scalar Default-MD objects
show ethoam vlan	Displays the vlan association for a specified VLAN-ID
show ethoam cfmstack	Displays the contents of CFM Stack Managed Object, which determines the relationships among MEPs and MIPs on a specific switch port.
show ethoam linktrace-reply	Displays the content of the Linktrace reply (LTR) returned by a previously transmitted LTM. This command displays the LTR based on the transaction identifier or sequence number of the LTM for which the LTR is to be displayed
show ethoam linktrace-tran-id	Displays the transaction identifiers returned by previously generated LTMs from a specified MEP.
show ethoam statistics	Displays the Ethernet OAM statistics of all the Management Domains configured on the switch. Also, displays the statistics of all the MAs and matching MEPs for all the MDs.
show ethoam config-error	Displays the configuration error for a specified VLAN, port or linkagg.

A Software License and Copyright Statements

This appendix contains Alcatel-Lucent and third-party software vendor license and copyright statements.

Alcatel-Lucent License Agreement

ALCATEL-LUCENT SOFTWARE LICENSE AGREEMENT

IMPORTANT. Please read the terms and conditions of this license agreement carefully before opening this package.

By opening this package, you accept and agree to the terms of this license agreement. If you are not willing to be bound by the terms of this license agreement, do not open this package. Please promptly return the product and any materials in unopened form to the place where you obtained it for a full refund.

1. **License Grant.** This is a license, not a sales agreement, between you (the “Licensee”) and Alcatel-Lucent. Alcatel-Lucent hereby grants to Licensee, and Licensee accepts, a non-exclusive license to use program media and computer software contained therein (the “Licensed Files”) and the accompanying user documentation (collectively the “Licensed Materials”), only as authorized in this License Agreement. Licensee, subject to the terms of this License Agreement, may use one copy of the Licensed Files on the Licensee’s system. Licensee agrees not to assign, sublicense, transfer, pledge, lease, rent, or share their rights under this License Agreement. Licensee may retain the program media for backup purposes with retention of the copyright and other proprietary notices. Except as authorized under this paragraph, no copies of the Licensed Materials or any portions thereof may be made by Licensee and Licensee shall not modify, decompile, disassemble, reverse engineer, or otherwise attempt to derive the Source Code. Licensee is also advised that Alcatel-Lucent products contain embedded software known as firmware which resides in silicon. Licensee may not copy the firmware or transfer the firmware to another medium.

2. **Alcatel-Lucent’s Rights.** Licensee acknowledges and agrees that the Licensed Materials are the sole property of Alcatel-Lucent and its licensors (herein “its licensors”), protected by U.S. copyright law, trademark law, and are licensed on a right to use basis. Licensee further acknowledges and agrees that all rights, title, and interest in and to the Licensed Materials are and shall remain with Alcatel-Lucent and its licensors and that no such right, license, or interest shall be asserted with respect to such copyrights and trademarks. This License Agreement does not convey to Licensee an interest in or to the Licensed Materials, but only a limited right to use revocable in accordance with the terms of this License Agreement.

3. **Confidentiality.** Alcatel-Lucent considers the Licensed Files to contain valuable trade secrets of Alcatel-Lucent, the unauthorized disclosure of which could cause irreparable harm to Alcatel-Lucent. Except as expressly set forth herein, Licensee agrees to use reasonable efforts not to disclose the Licensed Files to any third party and not to use the Licensed Files other than for the purpose authorized by this License Agreement. This confidentiality obligation shall continue after any termination of this License Agreement.

4. **Indemnity.** Licensee agrees to indemnify, defend and hold Alcatel-Lucent harmless from any claim, lawsuit, legal proceeding, settlement or judgment (including without limitation Alcatel-Lucent's reasonable United States and local attorneys' and expert witnesses' fees and costs) arising out of or in connection with the unauthorized copying, marketing, performance or distribution of the Licensed Files.

5. **Limited Warranty.** Alcatel-Lucent warrants, for Licensee's benefit alone, that the program media shall, for a period of ninety (90) days from the date of commencement of this License Agreement (referred to as the Warranty Period), be free from defects in material and workmanship. Alcatel-Lucent further warrants, for Licensee benefit alone, that during the Warranty Period the Licensed Files shall operate substantially in accordance with the functional specifications in the User Guide. If during the Warranty Period, a defect in the Licensed Files appears, Licensee may return the Licensed Files to Alcatel-Lucent for either replacement or, if so elected by Alcatel-Lucent, refund of amounts paid by Licensee under this License Agreement. EXCEPT FOR THE WARRANTIES SET FORTH ABOVE, THE LICENSED MATERIALS ARE LICENSED "AS IS" AND ALCATEL-LUCENT AND ITS LICENSORS DISCLAIM ANY AND ALL OTHER WARRANTIES, WHETHER EXPRESS OR IMPLIED, INCLUDING (WITHOUT LIMITATION) ANY IMPLIED WARRANTIES OF MERCHANTABILITY OR FITNESS FOR A PARTICULAR PURPOSE. SOME STATES DO NOT ALLOW THE EXCLUSION OF IMPLIED WARRANTIES SO THE ABOVE EXCLUSIONS MAY NOT APPLY TO LICENSEE. THIS WARRANTY GIVES THE LICENSEE SPECIFIC LEGAL RIGHTS. LICENSEE MAY ALSO HAVE OTHER RIGHTS WHICH VARY FROM STATE TO STATE.

6. **Limitation of Liability.** Alcatel-Lucent's cumulative liability to Licensee or any other party for any loss or damages resulting from any claims, demands, or actions arising out of or relating to this License Agreement shall not exceed the license fee paid to Alcatel-Lucent for the Licensed Materials. IN NO EVENT SHALL ALCATEL-LUCENT BE LIABLE FOR ANY INDIRECT, INCIDENTAL, CONSEQUENTIAL, SPECIAL, OR EXEMPLARY DAMAGES OR LOST PROFITS, EVEN IF ALCATEL-LUCENT HAS BEEN ADVISED OF THE POSSIBILITY OF SUCH DAMAGES. SOME STATES DO NOT ALLOW THE LIMITATION OR EXCLUSION OF LIABILITY FOR INCIDENTAL OR CONSEQUENTIAL DAMAGES, SO THE ABOVE LIMITATION OR EXCLUSION TO INCIDENTAL OR CONSEQUENTIAL DAMAGES MAY NOT APPLY TO LICENSEE.

7. **Export Control.** This product is subject to the jurisdiction of the United States. Licensee may not export or reexport the Licensed Files, without complying with all United States export laws and regulations, including but not limited to (i) obtaining prior authorization from the U.S. Department of Commerce if a validated export license is required, and (ii) obtaining "written assurances" from licensees, if required.

8. **Support and Maintenance.** Except as may be provided in a separate agreement between Alcatel-Lucent and Licensee, if any, Alcatel-Lucent is under no obligation to maintain or support the copies of the Licensed Files made and distributed hereunder and Alcatel-Lucent has no obligation to furnish Licensee with any further assistance, documentation or information of any nature or kind.

9. **Term.** This License Agreement is effective upon Licensee opening this package and shall continue until terminated. Licensee may terminate this License Agreement at any time by returning the Licensed Materials and all copies thereof and extracts therefrom to Alcatel-Lucent and certifying to Alcatel-Lucent in writing that all Licensed Materials and all copies thereof and extracts therefrom have been returned or erased by the memory of Licensee's computer or made non-readable. Alcatel-Lucent may terminate this License Agreement upon the breach by Licensee of any term hereof. Upon such termination by Alcatel-

Lucent, Licensee agrees to return to Alcatel-Lucent or destroy the Licensed Materials and all copies and portions thereof.

10. Governing Law. This License Agreement shall be construed and governed in accordance with the laws of the State of California.

11. Severability. Should any term of this License Agreement be declared void or unenforceable by any court of competent jurisdiction, such declaration shall have no effect on the remaining terms herein.

12. No Waiver. The failure of either party to enforce any rights granted hereunder or to take action against the other party in the event of any breach hereunder shall not be deemed a waiver by that party as to subsequent enforcement of rights or subsequent actions in the event of future breaches.

13. Notes to United States Government Users. Software and documentation are provided with restricted rights. Use, duplication or disclosure by the government is subject to (i) restrictions set forth in GSA ADP Schedule Contract with Alcatel-Lucent's reseller(s), or (ii) restrictions set forth in subparagraph (c) (1) and (2) of 48 CFR 52.227-19, as applicable.

14. Third Party Materials. Licensee is notified that the Licensed Files contain third party software and materials licensed to Alcatel-Lucent by certain third party licensors. Some third party licensors are third party beneficiaries to this License Agreement with full rights of enforcement. Please refer to the section entitled "[Third Party Licenses and Notices](#)" on page -4 for the third party license and notice terms.

Third Party Licenses and Notices

Legal Notices applicable to any software distributed alone or in connection with the product to which this document pertains are contained in files within the software itself located at: **/flash/foss**. FOSS (Free and Open Source Software) source code available upon request.

Index

Numerics

- 10/100/1000 ports
 - defaults 1-4
- 802.1AB 14-1
 - defaults 14-3
 - specifications 14-2
 - verify information about 14-16
- 802.1Q
 - enabling notification 14-11
 - trusted ports 27-22
- 802.1X
 - specifications 30-2, 31-3, 32-3
- 802.1x** command 31-8, 31-10
- 802.3ad
 - see* dynamic link aggregation

A

- aaa ldap-server** command
 - LDAP authentication 29-25
- aaa radius-server** command
 - RADIUS authentication 29-11, 29-13
- Access Control Lists
 - see* ACLs
- access list 20-15
 - creating 20-15
- ACLs
 - interaction with VRRP 24-10, 24-19
 - Layer 2 27-55
 - Layer 3 27-57
 - Layer 3 application examples 27-57
 - multicast 27-58
 - security features 27-59
- actions
 - combined with conditions 27-24, 27-25
 - creating policy actions 27-38
- Address Resolution Protocol
 - see* ARP
- Alcatel Mapping Adjacency Protocol 15-1
- alerts 37-7
- AMAP
 - see* Alcatel Mapping Adjacency Protocol
- Application example
 - Learned Port Security Configuration 34-3
- application example
 - Ethernet OAM 38-8
 - VLAN Stacking 16-2, 16-36
- application examples
 - authentication servers 29-4
 - Configuring 802.1AB 14-4
 - DHCP Relay 22-4, 22-7, 22-8

- dynamic link aggregation 10-4, 10-26
- high availability VLANs 5-3
- ICMP policies 27-69
- IP 16-4
- IPMS 26-37, 26-39
- IPv6 18-5
- Layer 3 ACLs 27-57
 - policies 27-66
 - policy map groups 27-52
 - Port Mapping 33-3, 33-7
 - port mirroring 35-4
 - port monitoring 35-6, 35-8
- QoS 27-35, 27-66
- RIP 20-3
- RMON 35-11
- Server Load Balancing 23-3, 25-4
- Spanning Tree Algorithm and Protocol 6-11, 6-44
- static link aggregation 9-3, 9-10
- switch health 35-13
- switch logging 37-3
- UDLD 2-3
- VLANs 4-3, 4-10
- VRRP 24-5, 24-26, 24-29
- VRRP3 24-30
- applied configuration 27-63
 - how to verify 27-65
- ARP
 - clearing the ARP cache 16-15
 - creating a permanent entry 16-14
 - deleting a permanent entry 16-14
 - dynamic entry 16-14
 - filtering 16-15
 - local proxy 16-15
- arp** command 16-14
- arp filter** command 16-15
- assigning ports to VLANs 4-6
- Authenticated Switch Access
 - LDAP VSAs 29-20
- authentication servers
 - application example 29-4
 - defaults 29-3
 - how backups work 29-5
 - see* LDAP authentication servers, RADIUS authentication servers
- automatic IP configuration 22-12

B

- backbone VLAN 7-18, 7-26
- backup router
 - VRRP 24-7
- BGP IPv6
 - configuring 16-35
- boundary port 6-19
- BPDU
 - see* Bridge Protocol Data Units
- bridge 1x1 slot/port path cost** command 6-38
- bridge auto-vlan-containment** command 6-33
- bridge cist hello time** command 6-28, 6-29, 6-30, 6-31

- bridge forward delay** command 6-31
 - bridge hello time** command 6-29
 - bridge max age** command 6-30, 6-32
 - bridge mode** command 6-21
 - bridge msti priority** command 6-29
 - bridge path cost mode** command 6-32
 - bridge priority** command 6-29
 - Bridge Protocol Data Units
 - contents 6-8
 - bridge slot/port** command 6-31
 - bridge slot/port connection** command 6-41
 - bridge slot/port priority** command 6-36
 - built-in port groups
 - used with Policy Based Routing 27-71
 - BVLAN *see* backbone VLAN
- C**
- clear arp filter** command 16-16
 - clear arp-cache** command 16-15
 - condition groups
 - for ACLs 27-45
 - MAC groups 27-49
 - network groups 27-46
 - port groups 27-50
 - sample configuration 27-45
 - service groups 27-48
 - verify information about 27-51
 - conditions
 - combined with actions 27-24, 27-25
 - configuring 27-36
 - how to create 27-36
 - see also* condition groups
 - valid combinations 27-23
 - Configuring 802.1AB
 - application examples 14-4
- D**
- debug messages 37-7
 - debug qos** command 27-31
 - default route
 - IP 16-13
 - defaults
 - 10/100/1000 ports 1-4
 - 802.1AB 14-3
 - authentication servers 29-3
 - DHCP Relay 22-3
 - dynamic link aggregation 10-3, 11-2
 - Ethernet OAM 15-2, 38-2
 - Ethernet ports 1-2, 1-4
 - high availability VLANs 5-2
 - IP 16-3
 - IPMS 26-3, 26-5
 - IPv6 18-4
 - Learned Port Security 34-2
 - Multiple Spanning Tree 6-5
 - OSPF 19-2, 21-2
 - policy servers 28-2
 - Port Mapping 33-2
 - port mirroring 35-3
 - port monitoring 35-5, 35-7
 - QoS 27-26
 - RIP 20-2
 - RMON 35-10
 - RRSTP 6-6
 - Server Load Balancing 25-3
 - source learning 3-2
 - Spanning Tree Bridge 6-4, 12-3
 - Spanning Tree Port 6-4
 - static link aggregation 9-2
 - switch health 35-13
 - switch logging 37-2
 - UDLD 2-2
 - VLANs 4-2
 - VRRP 24-3
 - Denial of Service
 - see* DoS
 - DHCP 22-5, 22-6
 - DHCP Relay 22-1, 22-10
 - application examples 22-4, 22-7, 22-8
 - AVLAN forwarding option 22-11
 - defaults 22-3
 - DHCP server IP address 22-9
 - forward delay time 22-10
 - maximum number of hops 22-11
 - standard forwarding option 22-11
 - statistics 22-26
 - directed broadcast 16-24
 - DoS 16-24
 - enabling traps 16-28
 - setting decay value 16-28
 - setting penalty values 16-27
 - Setting Port Scan Penalty Value 16-28
 - DVMRP 26-8
 - dynamic link aggregation 10-1, 11-1
 - application examples 10-4, 10-26
 - defaults 10-3, 11-2
 - group actor administrative key 10-14
 - group actor system ID 10-15
 - group actor system priority 10-14
 - group administrative state 10-13
 - group partner administrative key 10-15
 - group partner system ID 10-16
 - group partner system priority 10-16
 - groups 10-9
 - assigning ports 10-10
 - creating groups 10-9
 - deleting groups 10-10
 - group names 10-13
 - removing ports 10-11
 - LACPDU bit settings 10-17, 10-21
 - LACPDU frames 10-17, 10-21
 - Link Aggregation Control Protocol (LACP) 10-6
 - MAC address 10-15, 10-16, 10-19, 10-23
 - port actor administrative priority 10-19
 - port actor port priority 10-20
 - port actor system administrative states 10-17
 - port actor system ID 10-19

- port partner administrative key 10-23
- port partner administrative priority 10-25
- port partner administrative state 10-21
- port partner administrative system ID 10-23
- port partner administrative system priority 10-24
- port partner port administrative status 10-24
- ports 10-10
- specifications 10-2, 11-2
- verify information about 10-29, 11-12

dynamic log

- LDAP accounting servers 29-23

E

errors 37-7

Ethernet

- defaults 1-2, 1-4
- flood rate 1-6, 1-7
- frame size 1-6
- full duplex 1-4
- half duplex 1-4
- specifications 1-2

Ethernet OAM

- application example 38-8
- configuration 38-9

Connectivity Fault Management

- Continuity Check Messages 38-5
- Link Trace Messages 38-5
- Loop-back Messages 38-5

- defaults 15-2, 38-2
- overview 38-3
- specifications 15-2, 38-2
- verification 15-16, 38-14

ethoam association ccm-interval command 38-10

ethoam association command 38-8

ethoam association mhf command 38-10, 38-11, 38-12

ethoam association-default command 38-10

ethoam domain command 15-4, 38-8

ethoam end-point command 38-8

ethoam intermediate-point command 38-8

ethoam linktrace command 38-12

ethoam loopback command 38-12

F

Fast Spanning Tree 6-6

filtering lists

- see* ACLs

flow command 1-7

H

health interval command 35-39, 38-12

health threshold command 35-38

health threshold limits

- displaying 35-39

high availability VLANs 5-1

- adding egress ports 5-7, 5-8
- adding ingress ports 5-7
- application examples 5-3

- configuration steps 5-6
- creating high availability VLANs 5-6
- defaults 5-2
- deleting egress ports 5-7
- deleting high availability VLANs 5-7
- displaying 5-16
- specifications 5-2
- traffic flow 5-5

Hot Standby Routing Protocol

- see* HSRP

HSRP

- not compatible with VRRP 24-3

I

ICMP 16-30

- control 16-32
- QoS policies for 27-69
- statistics 16-32

icmp messages command 16-32

icmp type command 16-31

IGMP

- multicast ACLs 27-55, 27-58

IGMP Spoofing 26-20

interfaces admin command 1-5

interfaces alias command 1-5

interfaces autoneg command 1-4

interfaces duplex command 1-4

interfaces flood multicast command 1-6

interfaces max frame command 1-6

interfaces no l2 statistics command 1-5

interfaces speed command 1-4

Internet Control Message Protocol

- see* ICMP

IP 16-1, 17-1

- application examples 16-4, 17-3
- ARP 16-13
- defaults 16-3
- directed broadcast 16-24
- ICMP 16-30
- ping 16-32
- protocols 16-5, 17-11
- router ID 16-17
- router port 16-8
- router primary address 16-17
- specifications 16-3
- static route 16-12, 18-20
- tracing an IP route 16-33
- TTL value 16-18
- UDP 16-34
- verify information about 16-37, 17-18

ip access-list address command 20-15

ip access-list command 20-15

ip default-ttl command 16-18

ip directed-broadcast command 16-24

ip dos scan close-port-penalty command 16-27

ip dos scan decay command 16-28

ip dos scan tcp open-port-penalty command 16-27

ip dos scan threshold command 16-28

- ip dos scan udp open-port-penalty** command 16-27
 - ip dos trap** command 16-28
 - ip helper address** command 22-9
 - ip helper boot-up** command 22-12
 - ip helper forward delay** command 22-10
 - ip helper maximum hops** command 22-11
 - ip helper per-vlan** command 22-11
 - ip helper standard** command 22-11
 - ip interface** command 20-3
 - ip load rip** command 20-3, 20-6
 - ip multicast igmp-proxy-version** command 26-10, 26-26
 - ip multicast neighbor-timeout** command 26-10, 26-17, 26-18, 26-26, 26-32
 - ip multicast query-interval** command 26-15, 26-16, 26-29
 - ip multicast static-member** command 26-12
 - ip multicast static-neighbor** command 26-27
 - ip multicast static-querier** command 26-12
 - IP Multicast Switching
 - see* IPMS
 - ip multicast switching** command 26-9, 26-20, 26-25, 26-34
 - IP multinetting 16-7
 - ip redist** command 20-12
 - ip rip force-holddowntimer** command 20-9
 - ip rip garbage-timer** command 20-10
 - ip rip holddown-timer** command 20-10
 - ip rip host-route** command 20-11
 - ip rip interface auth-key** command 20-18
 - ip rip interface auth-type** command 20-18
 - ip rip interface** command 20-3, 20-7
 - ip rip interface metric** command 20-8
 - ip rip interface rcv-version** command 20-8
 - ip rip interface send-version** command 20-7
 - ip rip interface status** command 20-3, 20-7
 - ip rip invalid-timer** command 20-10
 - ip rip route-tag** command 20-9
 - ip rip status** command 20-3, 20-7
 - ip rip update-interval** command 20-9
 - ip route-pref** command 16-17
 - IP router ports 16-8
 - modifying 16-9
 - removing 16-9, 17-17
 - ip router primary-address** command 16-17
 - ip router router-id** command 16-17
 - ip service** command 16-29, 16-39
 - ip slb admin** command 25-4, 25-11
 - ip slb cluster admin status** command 25-17
 - ip slb cluster** command 25-4, 25-5, 25-12
 - ip slb cluster ping period** command 25-15
 - ip slb cluster ping retries** command 25-16
 - ip slb cluster ping timeout** command 25-15
 - ip slb probe** command 25-18, 25-19
 - ip slb probe expect** command 25-21
 - ip slb probe password** command 25-20
 - ip slb probe period** command 25-19
 - ip slb probe port** command 25-20
 - ip slb probe retries** command 25-20
 - ip slb probe send** command 25-21
 - ip slb probe status** command 25-21
 - ip slb probe timeout** command 25-19
 - ip slb probe url** command 25-21
 - ip slb probe username** command 25-20
 - ip slb server ip cluster** command 25-4, 25-5, 25-14, 25-16, 25-17
 - ip static-route** command 16-12, 18-20
 - IPMS 26-1
 - adding static members 26-12, 26-13, 26-14
 - adding static neighbors 26-11
 - adding static queriers 26-12
 - application examples 26-37, 26-39
 - defaults 26-3, 26-5
 - deleting static members 26-12, 26-28
 - deleting static neighbors 26-12
 - deleting static queriers 26-12, 26-28
 - displaying 26-41, 26-42
 - DVMRP 26-8
 - enabling 26-9, 26-20, 26-21, 26-22, 26-34, 26-35, 26-36
 - IGMPv2 26-11, 26-27
 - IGMPv3 26-8, 26-11, 26-26
 - neighbor timeout 26-17, 26-18, 26-19, 26-31, 26-33
 - optional multicast routing software 26-7
 - overview 26-6
 - PIM-SM 26-8
 - query interval 26-15, 26-16, 26-29, 26-30
 - RFCs 26-2, 26-3
 - specifications 26-2, 26-3
 - IPv6 18-1
 - addressing 18-7
 - application examples 18-5
 - autoconfiguration of addresses 18-9
 - defaults 18-4
 - specification 18-2
 - tunneling types 18-19
 - verify information about 18-32
 - ipv6 access-list address** command 20-15
 - ipv6 access-list** command 20-15
 - ipv6 address** command 18-5, 18-17
 - ipv6 interface** command 18-5, 18-15, 18-16
 - ipv6 interface tunnel source destination** command 18-15
 - ipv6 load rip** command 18-5
 - ipv6 rip interface** command 18-5
 - ipv6 route-pref** command 18-21
 - ISIS-SPB 7-9
- ## J
- jumbo frames 1-2
- ## L
- ### LACP
- see* dynamic link aggregation
 - lacp agg actor admin key** command 10-4, 10-10
 - lacp agg actor admin state** command 10-17
 - lacp agg actor port priority** command 10-20
 - lacp agg actor system id** command 10-19
 - lacp agg actor system priority** command 10-19
 - lacp agg partner admin key** command 10-23
 - lacp agg partner admin port** command 10-24
 - lacp agg partner admin port priority** command 10-25

- lacp agg partner admin state** command 10-21
- lacp agg partner admin system id** command 10-23
- lacp agg partner admin system priority** command 10-24
- lacp linkagg actor admin key** command 10-14
- lacp linkagg actor system id** command 10-15
- lacp linkagg actor system priority** command 10-14
- lacp linkagg admin state** command 10-13
- lacp linkagg name** command 10-13
- lacp linkagg partner admin key** command 10-15
- lacp linkagg partner system id** command 10-16
- lacp linkagg partner system priority** command 10-16
- lacp linkagg size** command 10-4, 10-9
- Layer 2
 - statistics counters 1-5
- LDAP accounting servers
 - dynamic log 29-23
 - standard attributes 29-22
- LDAP authentication servers
 - directory entries 29-16
 - functional privileges 29-21
 - passwords for 29-19
 - schema extensions 29-16
 - SNMP attributes on authentication servers 29-21
 - SSL 29-25
 - VSAs for Authenticated Switch Access 29-20
- LDAP servers
 - see* policy servers
 - used for QoS policies 28-3
- Learned Port Security
 - database table 34-9
 - defaults 34-2
 - disabling 34-12
 - enabling 34-12
 - overview 34-5
 - specifications 34-2
- Learned Port Security Configuration
 - Application example 34-3
- Lightweight Directory Access Protocol
 - see* LDAP servers
- line speed 1-4
- link aggregation
 - dynamic link aggregation 10-1, 11-1
 - Spanning Tree parameters 6-36, 6-37, 6-38, 6-40, 6-42
 - static link aggregation 9-1
- lldp lldpdu** command 14-4
- lldp notification** command 14-4
- lldp tlv dot1** command 14-13
- lldp tlv dot3** command 14-13
- lldp tlv management** command 14-4
- lldp tlv med** command 14-14
- logged events
 - detail level 27-32
 - types of events 27-31
- M**
- MAC address table 3-1, 3-3
 - aging time 3-7
 - duplicate MAC addresses 3-3
 - learned MAC addresses 3-3
 - static MAC addresses 3-3
- MAC addresses
 - aging time 3-7, 6-30
 - dynamic link aggregation 10-15, 10-16, 10-19, 10-23
 - learned 3-3
 - statically assigned 3-3
- mac-address-table** command 3-3
- map groups 27-52
 - application 27-70
 - creating 27-53
 - verifying information 27-54
- master router
 - VRRP 24-7
- MLD Zapping 26-35
- MST 6-13
 - Internal Spanning Tree (IST) Instance 6-18
 - Interoperability 6-19
 - Migration 6-19, 6-20
 - MSTI 6-16
 - MSTP 6-13
 - Multiple Spanning Tree Region 6-17
- Multicast Listener Discovery (MLD) 26-26
- Multiple Spanning Tree
 - defaults 6-5
- N**
- non combo ports
 - configuring 1-4
- O**
- OSPF 20-4
 - defaults 19-2, 21-2
 - loading software 21-12
 - specifications 19-2, 21-2
- OSPF redistribution policies
 - deleting 16-20, 16-22, 18-24, 18-26, 20-16
- P**
- PBB *see* Provider Backbone Bridge
- pending configuration 27-63
- pending policies
 - deleting 27-63
- Per VLAN DHCP 22-9
- PIM-SM 26-8
- ping
 - IP 16-32
- ping** command 16-32
- policies
 - application examples 27-66
 - applied 27-63
 - built-in 27-29
 - conditions 27-36
 - creating policy actions 27-38
 - how the switch uses them 27-21
 - Policy Based Routing 27-71
 - precedence 27-40

- redirect linkagg 27-68
 - redirect port 27-68
 - rules 27-39
 - verify information about 27-44
 - policies configured via PolicyView 27-65
 - policy action 802.1p** command 27-8
 - policy action** command 27-35
 - policy action map** command 27-52
 - policy action redirect linkagg** command 27-68
 - policy action redirect port** command 27-68, 27-69
 - policy actions
 - see* actions
 - Policy Based Routing 27-71
 - policy condition** command 27-35
 - policy conditions
 - see* conditions
 - policy MAC groups 27-49
 - policy map group** command 27-52
 - policy map groups
 - application example 27-52
 - policy network group** command 27-45
 - policy network groups 27-46
 - switch** default group 27-29, 27-46
 - policy port group** command 27-45
 - policy port groups 27-50
 - policy rule** command 27-35
 - policy server** command 28-2, 28-4
 - policy server flush** command 28-6
 - compared to **qos flush** command 28-7
 - policy server load** command 28-6
 - policy servers
 - defaults 28-2
 - downloading policies 28-6
 - installing 28-3
 - SSL 28-6
 - policy service group** command 27-45
 - policy service groups 27-48
 - policy services 27-47
 - PolicyView
 - LDAP policy servers 28-1
 - Port Mapping 33-1
 - application examples 33-3, 33-7
 - defaults 33-2
 - specifications 33-2
 - port mapping** command 33-3
 - Port Mapping Session
 - creating and deleting 33-4
 - enabling and disabling 33-5
 - port mirroring 35-14
 - application examples 35-4
 - defaults 35-3
 - direction 35-19
 - disabling mirroring status 35-19
 - displaying status 35-20
 - enabling or disabling mirroring status 35-18
 - N-to-1 port mirroring 35-18
 - specifications 35-3
 - unblocking ports 35-18
 - port mirroring** command 35-20
 - port mirroring session
 - creating 35-17
 - deleting 35-20
 - enabling/disabling 35-20
 - port mirroring source** command 35-6
 - port mirroring source destination** command 35-17, 35-19
 - port monitoring
 - application examples 35-6, 35-8
 - configuring 35-23, 35-27
 - creating a data file 35-24
 - defaults 35-5, 35-7
 - deleting a session 35-23, 35-29
 - direction 35-25
 - disabling a session 35-23
 - displaying status and data 35-25, 35-28, 35-29
 - enabling a session 35-23
 - file overwriting 35-24
 - file size 35-24
 - overview 35-22, 35-26
 - pausing a session 35-24
 - resuming a session 35-24
 - session persistence 35-24
 - specifications 35-5, 35-7
 - port monitoring** command 35-23, 35-24
 - port monitoring source** command 35-23, 35-24, 35-25, 35-27
 - ports
 - displaying QoS information about 27-7
 - Spanning Tree parameters 6-34
 - VLAN assignment 4-6
 - port-security** command 34-12
 - port-security learning-window** command 34-13
 - Precedence
 - Configured rule order 27-40
 - Precedence value 27-40
 - precedence
 - for policies 27-40
 - Provider Backbone Bridge
 - 802.1AH 7-6
 - network 7-6
 - SPB services 7-12
- ## Q
- QoS
 - application examples 27-35, 27-66
 - ASCII-file-only syntax 17-9, 27-36
 - configuration overview 27-30
 - defaults 27-26
 - enabled/disabled 27-31
 - interaction with other features 27-22
 - overview 27-3
 - quick steps for creating policies 27-35
 - Server Load Balancing 25-13
 - Specifications 27-2
 - traffic prioritization 27-66
 - qos apply** command 27-63
 - global configuration 27-63
 - policy and port configuration 27-63

- qos clear log** command 27-34
 - qos** command 27-31
 - qos flush** command 27-64
 - compared to **policy server flush** command 28-7
 - qos forward log** command 27-32
 - QoS log
 - cleared 27-34
 - displayed 27-33
 - number of display lines 27-32
 - see also* logged events
 - qos log level** command 27-31, 27-32
 - qos log lines** command 27-32
 - qos port default 802.1p** command 27-7
 - qos port default dscp** command 27-7
 - qos port trusted** command 27-7
 - qos reset** command 27-34
 - qos revert** command 27-63
 - qos stats interval** command 27-34
 - qos trust ports** command 27-7
 - qos user-port** command 27-60
 - Quality of Service
 - see* QoS
- R**
- RADIUS accounting servers
 - standard attributes 29-10
 - VSAAs 29-11
 - RADIUS authentication servers 29-7
 - standard attributes 29-7
 - VSAAs 29-9, 31-82
 - Rapid Spanning Tree Algorithm and Protocol
 - see* RSTP
 - Redirection Policies 27-68
 - Remote Authentication Dial-In User Service
 - see* RADIUS authentication servers
 - resource threshold limits
 - configuring 35-38
 - Ring Rapid Spanning Tree Algorithm and Protocol
 - see* RRSTP
 - RIP 20-1
 - application examples 20-3
 - defaults 20-2
 - enabling 20-7
 - forced hold-down timer 20-9
 - garbage timer 20-10
 - hold-down timer 20-10
 - host route 20-11
 - interface 20-7
 - invalid timer 20-10
 - IP 20-4
 - loading 20-6
 - redistribution 20-12
 - security 20-18
 - specifications 20-2
 - unloading 20-6
 - update interval 20-9
 - verification 20-19
 - verify information about 20-19
 - RIP interface
 - creating 20-7
 - deleting 20-7
 - enabling 20-7
 - metric 20-8
 - password 20-18
 - receive option 20-8
 - route tag 20-9
 - send option 20-7
 - RMON
 - application examples 35-11
 - defaults 35-10
 - specifications 35-10
 - RMON events
 - displaying list 35-36
 - displaying specific 35-36
 - RMON probes
 - displaying list 35-33
 - displaying statistics 35-34
 - enabling/disabling 35-32
 - rmon probes** command 35-32
 - RMON tables
 - displaying 35-33
 - round robin distribution algorithm
 - see* weighted round robin distribution algorithm
 - route map
 - creating 20-13
 - deleting 20-14
 - enabling/disabling administrative status 20-16
 - redistribution 20-16
 - sequencing 20-14
 - router ID 16-17, 18-21
 - router port
 - IP 16-8
 - router primary address 16-17
 - Routing Information Protocol
 - see* RIP
 - RRSTP 6-44
 - defaults 6-6
 - RSTP 6-6
 - port connection types 6-41
 - rules
 - see* policies
- S**
- sampling intervals
 - configuring 35-39, 38-12
 - viewing 35-39
 - Secure Socket Layer
 - see* SSL
 - Security Violation Mode 34-18
 - restrict** mode 34-18
 - server clusters 25-12, 25-17
 - server distribution algorithms 25-9
 - Server Load Balancing 25-1
 - adding servers 25-14
 - application examples 23-3, 25-4
 - clusters 25-12, 25-17

- configuration steps 25-11
- defaults 25-3
- deleting clusters 25-14
- deleting servers 25-14
- disabling 25-11
- disabling clusters 25-17
- disabling servers 25-18
- displaying 25-22
- distribution algorithms 25-9
- enabling 25-11
- enabling clusters 25-17
- enabling servers 25-17
- ping period 25-15
- ping retries 25-16
- ping timeout 25-15
- QoS 25-13
- relative server weight 25-16
- server health monitoring 25-10
- servers 25-14, 25-17
- specifications 25-2
- weighted round robin distribution algorithm 25-9
- Server Load Balancing probes 25-18
 - clusters 25-19
 - configuring 25-18
 - deleting 25-18
 - expected status 25-21
 - modifying 25-19
 - password 25-20
 - probe expect 25-21
 - probe send 25-21
 - retries 25-20
 - servers 25-19
 - TCP/UDP port 25-20
 - timeout 25-19
 - URL 25-21
 - user name 25-20
- service access l2profile** command 7-41
- service access vlan-xlation** command 7-37, 7-40
- service l2profile** command 7-41
- service spb admin-state** command 7-37
- service spb** command 7-36
- service spb sap admin-state** command 7-44
- service spb sap** command 7-42
- service spb sap trusted** command 7-43
- service spb vlan-xlation** command 7-37
- severity level
 - see* switch logging
- Shortest Path Bridging 7-1, 7-6
 - benefits 7-1
 - bridge ID 7-31
 - bridge priority 7-31
 - BVLAN 7-26
 - ISIS-SPB 7-9
 - services 7-12
 - shortest path trees 7-8
 - SPT 7-8
 - system ID 7-31
 - topology example 7-13
- show arp** command 16-14
- show arp filter** command 16-16, 16-29
- show health** command 35-40
- show health interval** command 35-39
- show health threshold** command 35-13, 35-39
- show icmp control** command 16-32
- show icmp statistics** command 16-32
- show ip config** command 16-18, 16-24
- show ip interface** command 16-9
- show ip redist** command 20-16
- show ip rip** command 20-7
- show ip rip interface** command 20-7
- show ip route** command 16-13, 18-20
- show ip route-map** command 20-13
- show ipv6 interface** command 18-15
- show linkagg** command 9-11
- show linkagg port** command 9-11
- show lldp remote-system** command 14-4
- show lldp statistics** command 14-4
- show log swlog** command 37-11
- show mac-address-table port-mac** command 5-16
- show policy rule** command 25-13
- show policy server long** command 28-6
- show port mirroring status** command 35-20
- show port monitoring file** command 35-25
- show port-security** command 34-3
- show port-security shutdown** command 34-3
- show qos log** command 27-33
- show rmon events** command 35-33
- show rmon probes** command 35-11, 35-33
- show tcp ports** command 16-33
- show tcp statistics** command 16-33
- show uddl configuration** command 2-3
- show uddl statistics port** command 2-3
- show udp ports** command 16-34
- show udp statistics** command 16-34
- show vlan svlan** command 13-13, 36-24
- show vlan svlan port-binding** command 13-13
- show vlan svlan port-config** command 13-13, 36-24
- SLB
 - see* Server Load Balancing
- SNMP
 - attributes for LDAP authentication servers 29-21
 - source learning 3-1
 - defaults 3-2
 - MAC address table 3-1, 3-3
 - source learning time limit 34-13
- Spanning Tree
 - specifications 6-3, 12-2
- Spanning Tree Algorithm and Protocol 6-1, 12-1
 - 1x1 operating mode 4-8, 6-21, 6-23
 - application examples 6-11, 6-44
 - bridge ID 6-8, 6-28
 - Bridge Protocol Data Units 6-8, 6-29, 6-30
 - bridged ports 6-34
 - designated bridge 6-6
 - flat operating mode 4-8, 6-21, 6-22
 - path cost 6-37, 6-38
 - port connection types 6-41
 - Port ID 6-8

- port ID 6-36
 - port path cost 6-6
 - port roles 6-6
 - port states 6-7, 6-40
 - root bridge 6-6, 6-29, 6-30
 - root path cost 6-6
 - topology 6-6, 6-12
 - Topology Change Notification 6-9
 - Spanning Tree Bridge
 - defaults 6-4, 12-3
 - Spanning Tree bridge parameters
 - 802.1D standard protocol 6-28
 - 802.1s multiple spanning tree protocol 6-28
 - 802.1w rapid reconfiguration protocol 6-28
 - automatic VLAN containment 6-32
 - forward delay time 6-30
 - hello time 6-29
 - maximum age time 6-30
 - priority 6-28
 - Spanning Tree Port
 - defaults 6-4
 - Spanning Tree port parameters 6-34
 - connection type 6-41
 - link aggregate ports 6-36, 6-37, 6-38, 6-40, 6-42
 - mode 6-40
 - path cost 6-37
 - priority 6-36
 - spb isis admin-state** command 7-35
 - spb isis area-address** command 7-31
 - spb isis bridge-priority** command 7-31
 - spb isis lsp-wait** command 7-33
 - spb isis overload** command 7-34
 - spb isis overload-on-boot** command 7-34
 - spb isis source-id** command 7-31
 - spb isis spf-wait** command 7-32
 - SPB *see* Shortest Path Bridging
 - specification
 - IPv6 18-2
 - Specifications
 - QoS 27-2
 - specifications
 - 802.1AB 14-2
 - dynamic link aggregation 10-2, 11-2
 - Ethernet 1-2
 - Ethernet OAM 15-2, 38-2
 - IP 16-3
 - OSPF 19-2, 21-2
 - Port Mapping 33-2
 - port mirroring 35-3
 - port monitoring 35-5, 35-7
 - RIP 20-2
 - RMON 35-10
 - Server Load Balancing 25-2
 - Spanning Tree 6-3, 12-2
 - static link aggregation 9-2
 - switch health 35-12
 - switch logging 37-2
 - UDLD 2-2
 - SSL
 - for LDAP authentication servers 29-25
 - policy servers 28-6
 - static agg agg num** command 9-3, 9-7
 - static link aggregation 9-1
 - adding ports 9-7
 - application examples 9-3, 9-10
 - configuration steps 9-6
 - creating 9-7
 - defaults 9-2
 - deleting 9-7
 - deleting ports 9-8
 - disabling 9-9
 - enabling 9-9
 - group names 9-9
 - groups 9-5, 10-6
 - overview 9-5, 10-6
 - specifications 9-2
 - verify information about 9-11
 - static linkagg admin state** command 9-9
 - static linkagg name** command 9-9
 - static linkagg size** command 9-3, 9-7
 - static MAC addresses 3-3
 - static route
 - IP 16-12, 18-20
 - metric 16-12, 18-20
 - subnet mask 16-12
 - subnet mask 16-12
 - switch health
 - application examples 35-13
 - defaults 35-13
 - monitoring 35-37
 - specifications 35-12
 - switch health statistics
 - resetting 35-40
 - viewing 35-40
 - switch logging
 - application examples 37-3
 - application ID 37-5
 - defaults 37-2
 - output 37-8
 - severity level 37-7
 - specifications 37-2
 - swlog appid level** command 37-5
 - swlog clear** command 37-10
 - swlog** command 37-3, 37-5
 - swlog output** command 27-33
 - swlog output** command 37-8
- ## T
- TCN BPDU
 - see* Topology Change Notification BPDU
 - TCP
 - statistics 16-33
 - time-to-live
 - see* TTL
 - Topology Change Notification BPDU 6-9
 - traceroute** command 16-33

- tracking
 - VRRP 24-9
 - traffic prioritization 27-66
 - trap port link** command 1-5
 - traps
 - port link messages 1-5
 - trusted ports
 - see also* ports
 - used with QoS policies 27-8
 - TTL value 16-18
 - Tunneling 18-11
- ## U
- UDLD
 - application examples 2-3
 - defaults 2-2
 - disabling on port 2-6
 - disabling on switch 2-6
 - enabling on port 2-6
 - overview 2-4
 - show 2-8
 - specifications 2-2
 - udld** command 2-3
 - udld port** command 2-3
 - UDP 16-34
 - statistics 16-34
 - User Datagram Protocol
 - see* UDP
 - users
 - functional privileges 29-21
- ## V
- Vendor Specific Attributes
 - see* VSAs
 - Virtual Router Redundancy Protocol
 - see* VRRP
 - virtual routers 24-7
 - vlan 802.1q** command 4-6
 - vlan authentication** command 4-9
 - vlan** command 5-6, 16-4, 17-3, 20-3
 - vlan port 802.1x** command 30-34
 - vlan port** command
 - and 802.1X ports 31-87
 - vlan port default** command 4-6, 16-4, 20-3
 - vlan port-mac egress-port** command 5-7, 5-8
 - vlan port-mac ingress-port** command 5-7
 - vlan router ip** command 16-4, 17-3, 17-4
 - VLAN Stacking
 - application example 16-2, 16-36
 - display list of all or range of configured SVLANs 12-27
 - displaying the configuration 36-24
 - vlan stp** command 4-8
 - vlan svlan** command 6-27
 - VLANs 4-1, 4-5, 12-4
 - administrative status 4-5
 - application examples 4-3, 4-10
 - default VLAN 4-6
 - defaults 4-2
 - description 4-5
 - high availability VLANs 5-1
 - IP multinetting 16-7
 - IP router ports 16-8
 - MAC address aging time 3-7
 - operational status 4-4
 - port assignment 4-6
 - Spanning Tree status 4-8
 - VLAN ID 4-4
 - VRRP 24-1
 - ACLs 24-10, 24-19
 - application example 24-5, 24-26, 24-29
 - ARP request 24-8
 - backup router 24-7
 - defaults 24-3
 - MAC address 24-8
 - master router 24-7
 - tracking 24-9
 - virtual routers 24-7
 - vrrp** command 24-10, 24-19
 - defaults 24-3
 - vrrp delay** command 24-14
 - vrrp ip** command 24-10, 24-19
 - vrrp track** command 24-25
 - vrrp track-association** command 24-25
 - vrrp trap** command 24-14, 24-23
 - VRRP3 24-19
 - Advertisement Interval 24-21
 - application examples 24-30
 - Preemption 24-22
 - Traps 24-23
 - Virtual Router 24-19
 - Virtual Router Priority 24-21
 - VSAs
 - for LDAP servers 29-20
 - for RADIUS authentication 29-7
 - RADIUS accounting servers 29-11
 - setting up for RADIUS servers 29-9, 31-82
- ## W
- warnings 37-7
 - weighted round robin distribution algorithm 25-9